

## Bridge Stormwater Runoff Analysis and Treatment Options

### DETAILS

---

197 pages | 8.5 x 11 | PAPERBACK

ISBN 978-0-309-40232-3 | DOI 10.17226/22395

### AUTHORS

---

Taylor, Scott; Barrett, Michael; Ward, George; Leisenring, Marc; Venner, Marie; and Roger Kilgore

BUY THIS BOOK

FIND RELATED TITLES

### Visit the National Academies Press at [NAP.edu](http://NAP.edu) and login or register to get:

---

- Access to free PDF downloads of thousands of scientific reports
- 10% off the price of print titles
- Email or social media notifications of new titles related to your interests
- Special offers and discounts



Distribution, posting, or copying of this PDF is strictly prohibited without written permission of the National Academies Press. (Request Permission) Unless otherwise indicated, all materials in this PDF are copyrighted by the National Academy of Sciences.

NATIONAL COOPERATIVE HIGHWAY RESEARCH PROGRAM

---

---

**NCHRP REPORT 778**

---

---

**Bridge Stormwater  
Runoff Analysis  
and Treatment Options**

**Scott Taylor**

MICHAEL BAKER INTERNATIONAL  
Carlsbad, CA

**Michael Barrett  
George Ward**

UNIVERSITY OF TEXAS  
Austin, TX

**Marc Leisenring**

GEOSYNTEC CONSULTANTS  
Portland, OR

**Marie Venner**

VENNER CONSULTING  
Littleton, CO

**Roger Kilgore**

KILGORE CONSULTING AND MANAGEMENT  
Denver, CO

*Subscriber Categories*

Bridges and Other Structures • Environment • Hydraulics and Hydrology

---

Research sponsored by the American Association of State Highway and Transportation Officials  
in cooperation with the Federal Highway Administration

---

**TRANSPORTATION RESEARCH BOARD**

WASHINGTON, D.C.  
2014  
[www.TRB.org](http://www.TRB.org)

## **NATIONAL COOPERATIVE HIGHWAY RESEARCH PROGRAM**

Systematic, well-designed research provides the most effective approach to the solution of many problems facing highway administrators and engineers. Often, highway problems are of local interest and can best be studied by highway departments individually or in cooperation with their state universities and others. However, the accelerating growth of highway transportation develops increasingly complex problems of wide interest to highway authorities. These problems are best studied through a coordinated program of cooperative research.

In recognition of these needs, the highway administrators of the American Association of State Highway and Transportation Officials initiated in 1962 an objective national highway research program employing modern scientific techniques. This program is supported on a continuing basis by funds from participating member states of the Association and it receives the full cooperation and support of the Federal Highway Administration, United States Department of Transportation.

The Transportation Research Board of the National Academies was requested by the Association to administer the research program because of the Board's recognized objectivity and understanding of modern research practices. The Board is uniquely suited for this purpose as it maintains an extensive committee structure from which authorities on any highway transportation subject may be drawn; it possesses avenues of communications and cooperation with federal, state and local governmental agencies, universities, and industry; its relationship to the National Research Council is an insurance of objectivity; it maintains a full-time research correlation staff of specialists in highway transportation matters to bring the findings of research directly to those who are in a position to use them.

The program is developed on the basis of research needs identified by chief administrators of the highway and transportation departments and by committees of AASHTO. Each year, specific areas of research needs to be included in the program are proposed to the National Research Council and the Board by the American Association of State Highway and Transportation Officials. Research projects to fulfill these needs are defined by the Board, and qualified research agencies are selected from those that have submitted proposals. Administration and surveillance of research contracts are the responsibilities of the National Research Council and the Transportation Research Board.

The needs for highway research are many, and the National Cooperative Highway Research Program can make significant contributions to the solution of highway transportation problems of mutual concern to many responsible groups. The program, however, is intended to complement rather than to substitute for or duplicate other highway research programs.

## **NCHRP REPORT 778**

Project 25-42  
ISSN 0077-5614  
ISBN 978-0-309-28415-8  
Library of Congress Control Number 2014941750

© 2014 National Academy of Sciences. All rights reserved.

### **COPYRIGHT INFORMATION**

Authors herein are responsible for the authenticity of their materials and for obtaining written permissions from publishers or persons who own the copyright to any previously published or copyrighted material used herein.

Cooperative Research Programs (CRP) grants permission to reproduce material in this publication for classroom and not-for-profit purposes. Permission is given with the understanding that none of the material will be used to imply TRB, AASHTO, FAA, FHWA, FMCSA, FTA, or Transit Development Corporation endorsement of a particular product, method, or practice. It is expected that those reproducing the material in this document for educational and not-for-profit uses will give appropriate acknowledgment of the source of any reprinted or reproduced material. For other uses of the material, request permission from CRP.

### **NOTICE**

The project that is the subject of this report was a part of the National Cooperative Highway Research Program, conducted by the Transportation Research Board with the approval of the Governing Board of the National Research Council.

The members of the technical panel selected to monitor this project and to review this report were chosen for their special competencies and with regard for appropriate balance. The report was reviewed by the technical panel and accepted for publication according to procedures established and overseen by the Transportation Research Board and approved by the Governing Board of the National Research Council.

The opinions and conclusions expressed or implied in this report are those of the researchers who performed the research and are not necessarily those of the Transportation Research Board, the National Research Council, or the program sponsors.

The Transportation Research Board of the National Academies, the National Research Council, and the sponsors of the National Cooperative Highway Research Program do not endorse products or manufacturers. Trade or manufacturers' names appear herein solely because they are considered essential to the object of the report.

*Published reports of the*

### **NATIONAL COOPERATIVE HIGHWAY RESEARCH PROGRAM**

*are available from:*

Transportation Research Board  
Business Office  
500 Fifth Street, NW  
Washington, DC 20001

*and can be ordered through the Internet at:*

<http://www.national-academies.org/trb/bookstore>

Printed in the United States of America

# THE NATIONAL ACADEMIES

*Advisers to the Nation on Science, Engineering, and Medicine*

The **National Academy of Sciences** is a private, nonprofit, self-perpetuating society of distinguished scholars engaged in scientific and engineering research, dedicated to the furtherance of science and technology and to their use for the general welfare. On the authority of the charter granted to it by the Congress in 1863, the Academy has a mandate that requires it to advise the federal government on scientific and technical matters. Dr. Ralph J. Cicerone is president of the National Academy of Sciences.

The **National Academy of Engineering** was established in 1964, under the charter of the National Academy of Sciences, as a parallel organization of outstanding engineers. It is autonomous in its administration and in the selection of its members, sharing with the National Academy of Sciences the responsibility for advising the federal government. The National Academy of Engineering also sponsors engineering programs aimed at meeting national needs, encourages education and research, and recognizes the superior achievements of engineers. Dr. C. D. Mote, Jr., is president of the National Academy of Engineering.

The **Institute of Medicine** was established in 1970 by the National Academy of Sciences to secure the services of eminent members of appropriate professions in the examination of policy matters pertaining to the health of the public. The Institute acts under the responsibility given to the National Academy of Sciences by its congressional charter to be an adviser to the federal government and, on its own initiative, to identify issues of medical care, research, and education. Dr. Harvey V. Fineberg is president of the Institute of Medicine.

The **National Research Council** was organized by the National Academy of Sciences in 1916 to associate the broad community of science and technology with the Academy's purposes of furthering knowledge and advising the federal government. Functioning in accordance with general policies determined by the Academy, the Council has become the principal operating agency of both the National Academy of Sciences and the National Academy of Engineering in providing services to the government, the public, and the scientific and engineering communities. The Council is administered jointly by both Academies and the Institute of Medicine. Dr. Ralph J. Cicerone and Dr. C. D. Mote, Jr., are chair and vice chair, respectively, of the National Research Council.

The **Transportation Research Board** is one of six major divisions of the National Research Council. The mission of the Transportation Research Board is to provide leadership in transportation innovation and progress through research and information exchange, conducted within a setting that is objective, interdisciplinary, and multimodal. The Board's varied activities annually engage about 7,000 engineers, scientists, and other transportation researchers and practitioners from the public and private sectors and academia, all of whom contribute their expertise in the public interest. The program is supported by state transportation departments, federal agencies including the component administrations of the U.S. Department of Transportation, and other organizations and individuals interested in the development of transportation. **[www.TRB.org](http://www.TRB.org)**

**[www.national-academies.org](http://www.national-academies.org)**



# COOPERATIVE RESEARCH PROGRAMS

## **CRP STAFF FOR NCHRP REPORT 778**

**Christopher W. Jenks**, *Director, Cooperative Research Programs*  
**Christopher J. Hedges**, *Manager, National Cooperative Highway Research Program*  
**Andrew C. Lemer**, *Senior Program Officer*  
**Sheila A. Moore**, *Program Associate*  
**Eileen P. Delaney**, *Director of Publications*  
**Margaret B. Hagood**, *Editor*

## **NCHRP PROJECT 25-42 PANEL** **Field of Transportation Planning—Area of Impact Analysis**

**Matthew S. Lauffer**, *North Carolina DOT, Raleigh, NC* (Chair)  
**Le Chi Nguyen**, *Washington State DOT, Seattle, WA*  
**Thomas J. Grizzard, Jr.**, *Virginia Polytechnic Institute and State University, Manassas, VA*  
**D. Keith Jones**, *California DOT, Davis, CA*  
**Jeffrey S. MacKay**, *NTM Engineering, Inc., Dillsburg, PA*  
**Alexander J. Murray**, *Massachusetts DOT, Boston, MA*  
**W. Wesley Peck**, *Tennessee DOT, Nashville, TN*  
**Chad R. Wagner**, *U.S. Geological Survey, Raleigh, NC*  
**Susan Jones**, *FHWA Liaison*  
**Stephen F. Maher**, *TRB Liaison*

## **AUTHOR ACKNOWLEDGMENTS**

This study was conducted with funding provided through NCHRP Project 25-42, Bridge Stormwater Runoff Analysis and Treatment Options. This document was prepared by Mr. Scott Taylor of RBF Consulting, and Dr. Michael Barrett and Dr. George Ward, University of Texas, Marc Leisenring, Geosyntec Consultants, Marie Venner, Venner Consulting and Roger Kilgore, Kilgore Consulting and Management.

# FOREWORD

By **Andrew C. Lemer**

Staff Officer

Transportation Research Board

This report presents information and an analysis process for identifying strategies for management of stormwater runoff from highway bridges. Departments of transportation (DOTs) and other public agencies responsible for managing stormwater runoff to reduce pollution loads in receiving waters may use this information and process to assist their selection of a cost-effective strategy for a particular bridge. The report will be helpful to designers and managers who must identify and assess the merits of stormwater management practices.

---

While most bridge stormwater runoff discharges directly to the water bodies below, state DOTs and local agencies are increasingly being encouraged to provide treatment. Such requirements initially have been applied to the runoff from on-grade pavements, but collection and treatment or other mitigation strategies for bridge runoff management pose particular challenges. What may be judged to be best management practices (BMPs) for on-grade pavement have limited effectiveness when applied to bridges.

Bridges account for a very small portion of the highway systems' runoff. Addressing increasingly stringent highway runoff regulatory requirements by applying on-grade runoff management practices to bridges is not only costly but may compromise worker and road-user safety with limited benefits to water quality.

The objective of NCHRP Project 25-42 was to develop a guide, for DOTs and others, for managing bridge runoff to protect environmental quality and meet regulatory requirements. The guide is intended to address such critical issues as characterization of bridge runoff and its effects on quality of receiving waters; current and emerging runoff management strategies that may be beneficial and cost-effective for application to bridges; criteria for identifying appropriate runoff management strategies for particular bridges; how bridge owners may establish appropriate levels of effort to address bridge runoff issues at a particular location; and how bridge owners may identify BMPs for bridge runoff and select or develop BMPs for a particular location.

A research team led by RBF Consulting, Carlsbad, CA, reviewed available literature and recent research, then systematically identified available bridge runoff management strategies and their likely benefits, lifecycle costs, and effectiveness in various settings. Using the information gathered, the team described a process and criteria DOTs can use to select BMPs for specific conditions where bridge runoff management is called for.

The guide presents the process and runoff treatment practices in a way designed to facilitate use by practitioners. It will assist agency staff and their advisors responsible for identifying and assessing the merits of options to manage stormwater runoff from specific highway bridges. This guide document is accompanied by computational spreadsheets that implement the guide's analysis process, available at the TRB web site at <http://www.trb.org/Main/Blurbs/170652.aspx>.

# CONTENTS

<b>1</b>	<b>Summary</b>
<b>4</b>	<b>Chapter 1 Overview</b>
4	1.1 Purpose
4	1.2 Pollution Removal Benefit of the Treatment of Bridge Deck Runoff
5	1.3 Runoff Treatment Evaluation Strategy
7	1.4 BMP Selection and Evaluation
8	1.5 Organization of the Guide
<b>9</b>	<b>Chapter 2 State of the Practice</b>
9	2.1 State of the Practice for Bridge Stormwater Management
9	2.1.1 Systems for Bridge Deck Runoff Capture
10	2.1.2 DOT Runoff Management Strategies for Bridges: Highlights from Interviews
11	2.1.3 Considerations and Limitations of Conveyance and Treatment as Identified by DOTs
11	2.1.4 Source Control Approaches
13	2.1.5 Other Strategies
13	2.2 Overview of Regulatory Requirements
13	2.2.1 NPDES Permits
14	2.2.2 Wetland Permitting
15	2.2.3 CWA Section 401 Water Quality Certification
15	2.3 Evaluation of Receiving Water Impacts
15	2.3.1 Bridge Deck Runoff Quality
16	2.3.2 Receiving Water Studies
18	2.3.3 Stormwater Quantity Impacts
18	2.3.4 Summary
<b>19</b>	<b>Chapter 3 Assessment Procedure</b>
19	3.1 Overview of Assessment Approach
19	3.1.1 Rural Areas
19	3.1.2 Urban Areas
20	3.1.3 Special Situations
20	3.1.4 Summary
20	3.2 Simple Assessment Procedure
21	3.3 Complex Assessment Procedure
21	3.3.1 Stream Environment
22	3.3.2 Lake Environment
22	3.3.3 Coastal Inlet Environment

<b>24</b>	<b>Chapter 4 Stormwater and Other Source Control Practices to Consider for All Bridges</b>
24	4.1 Collection and Conveyance of Deck Runoff
24	4.1.1 Scour Protection at Collection System Discharge Points
25	4.2 Bird Roosting
25	4.2.1 Background
26	4.2.2 BMPs to Discourage Roosting under Bridges
27	4.3 Bridge Construction Materials
28	4.4 Bridge Maintenance
28	4.4.1 Painting Materials and Methods
29	4.4.2 Bridge Washing
29	4.4.3 Winter Maintenance
31	4.4.4 Sweeping
33	4.4.5 Scupper Plugs
34	4.4.6 Summary
34	4.5 Bridge Inspection
<b>36</b>	<b>Chapter 5 Stormwater Treatment Controls for Bridges</b>
36	5.1 Tool Overview
37	5.2 Bridge Deck Conveyance Systems
38	5.2.1 Offset Deck Drain and Raised Scuppers
39	5.3 Treatment Controls
39	5.3.1 Treatment at the Abutment
43	5.3.2 Bridge Scupper Treatment Concept
44	5.3.3 PFC
45	5.3.4 Floating Pile Wetland
46	5.3.5 Offsite Mitigation
47	5.4 Spill Controls
47	5.4.1 Bridge Spill Frequency
47	5.4.2 Bridge Spill Costs
47	5.4.3 Bridge Spill Characteristics
48	5.4.4 Recommended Spill Control Criteria
48	5.4.5 Recommended Structural Spill Control BMPs
48	5.4.6 Spill Control Case Studies
<b>50</b>	<b>Chapter 6 BMP Evaluation Tool</b>
50	6.1 BMP Evaluation Tool Overview
50	6.1.1 Tool Assessment Functions
50	6.1.2 Tool Calculation Methodology
51	6.1.3 Pollutant Loading
52	6.1.4 Tool Inputs
52	6.1.5 Tool Results and Interpretations
54	6.1.6 Tool Supporting Data
54	6.2 Worked Example of Tool
54	6.2.1 Project Locations and Climate Selection
54	6.2.2 Project Options
54	6.2.3 Project Design
56	6.2.4 Results
58	6.3 Tool Customization
58	6.4 Tool Intended Uses

58	6.4.1 Direct Tool Uses
59	6.4.2 Indirect Tool Uses
60	References
A-1	<b>Appendix A</b> Literature Review
B-1	<b>Appendix B</b> Simple and Complex Assessment Methods and Worked Example
C-1	<b>Appendix C</b> Quick Start Guide
D-1	<b>Appendix D</b> User's Guide for the BMP Evaluation Tool
E-1	<b>Appendix E</b> BMP Evaluation Tool Modeling Methodology

---

Note: Many of the photographs, figures, and tables in this report have been converted from color to grayscale for printing. The electronic version of the report (posted on the Web at [www.trb.org](http://www.trb.org)) retains the color versions.

## S U M M A R Y

# Bridge Stormwater Runoff Analysis and Treatment Options

Studies have been conducted regarding the design, operation, construction and effectiveness of best management practices (BMPs) for the control of highway runoff water quality but few have investigated BMPs specifically for bridge deck runoff. While pollutant loads from highways are similar to those from bridge decks, highway pollutant loads can be more easily treated or sequestered, whereas loads from bridge decks are transported directly to receiving waters via dry deposition or stormwater runoff. Studies reviewed on the impact of bridge deck runoff on receiving waters found little evidence of either water quality or ecosystem degradation, leaving open the question of what stormwater controls, if any, are appropriate for the practitioner to apply for new and reconstruction bridge projects in the event that stormwater mitigation must be included.

This guide was developed to provide the practitioner with a stepwise approach to select the best combination of source control, operational and treatment control BMPs for a bridge crossing a perennial, intermittent or ephemeral stream, river, lake or estuary, for virtually any span length. Runoff from a bridge deck may *contribute* to receiving water quality impairment in areas where the pollutants in the receiving water are elevated due to urbanization or a non-point source. Solutions to managing this contribution to pollution have a range of costs. The practitioner must be the steward of public funding and the environment, balancing the objectives of each to ensure sustainability. The information in this guide provides a practical approach to assist the practitioner in this regard and to develop clear documentation of the decision process.

## **Assessment Framework**

The assessment framework begins at the project environmental documentation stage. Supporting technical studies for the National Environmental Policy Act (NEPA) and companion state environmental assessment documents will generally follow National Pollutant Discharge Elimination System (NPDES) regulations. However, the detail in environmental documents and supporting technical studies may vary, and there may be no discussion of bridge deck runoff requirements. The practitioner may be engaged to provide technical information during the environmental documentation phase, and the information in this Guide can assist in providing a supportable technical analysis.

The guide framework defines two general cases for bridge assessment: rural and urban. The rural case (category) is defined as a bridge in any location that is not covered by an NPDES permit or in a location that is outside of an urbanized area and that would not normally require treatment of runoff. The Bureau of the Census determines urbanized areas by applying a detailed set of published criteria (see 55 FR 42592, October 22, 1990).

The urban category of the guide assessment framework is defined as a bridge crossing located in an area subject to NPDES Permit coverage based on census urbanized area criteria. The NPDES Permit may likely have requirements for BMP application to all roadways, including bridges, which are part of a project. Bridges in urban areas are no more likely to cause receiving water pollution than rural areas, but they may contribute to pollution that is already present. Note also that average annual daily traffic has been determined to be a significant variable in the magnitude of pollutant load from highways.

Chapter 4 of the guide describes BMPs that should be considered, as applicable, for all bridge projects. These are source control and maintenance and operational BMPs that may only apply to certain material types (such as exposed zinc surfaces) or in specific locations (such as where deicers are used), but should be evaluated as the most environmentally relevant and cost-effective method of pollution control. This chapter also discusses bridge inspection as a tool to reduce the discharge of pollutants from bridges.

Bridge crossings will also likely be subject to one or more resource agency permits. Nationally, the U.S. Army Corps of Engineers (USACE) administers the Section 404 permit system of the Clean Water Act under the authority of the US Environmental Protection Agency (EPA). A Section 404 permit is required to deposit or remove dredge material from waters of the United States. A companion state permit may be required for work in waters of the state. A Section 404 permit requires a Section 401 certification from the state (or the USEPA if the state is non-delegated). The 404 permit, or 401 water quality certification, may include BMP requirements as mitigation for receiving water impacts. The BMP requirements in resource permits should provide environmental benefits consistent with whole life costs. The practitioner can assist the regulatory agencies in making this determination, if needed, by developing a numeric evaluation of potential impacts to the receiving water from the bridge runoff and assessing the costs of BMPs. The guide provides two assessment procedures to assist the practitioner in determining if the project will cause, or could contribute to, receiving water pollution. The simple assessment is a generic dilution-based procedure that provides an estimate of the pollutant contribution from bridge runoff relative to the receiving water. In many cases, this simple procedure can demonstrate that the contribution of the bridge deck runoff to the receiving water is de minimis.

For instances when a post-construction, refined estimate of receiving water pollutant concentration(s) is needed, the complex assessment procedure should be used. The complex assessment procedure is also dilution based, but follows a more rigorous mathematical approach to arrive at a conservative estimate of pollutant concentration in the receiving water based on the critical stream discharge rate. The guide provides a spreadsheet tool that can assist the practitioner in estimating BMP performance and costs.

## **Treatment BMPs and Bridges**

The use of treatment BMPs for bridge deck runoff is problematic because there are few viable options for treatment of runoff on the deck, and routine maintenance on the deck is difficult and dangerous due to the lack of workspace. Additional BMPs can be considered if stormwater is conveyed back to the bridge abutment. For some projects, the use of treatment BMPs may be mandated or prudent from an environmental perspective. Treatment BMPs that the practitioner can consider when treatment of deck runoff is required are described in Chapter 5. Treatment of runoff from a comparable section of highway on land is preferable to treatment of runoff from the bridge deck for two reasons. First, it is difficult (expensive) to convey bridge deck runoff to the abutment for treatment. Bridge deck conveyance systems are costly to design, construct, and maintain. Second, it is not as effective to treat runoff from bridge decks as it is to treat runoff from a terrestrial highway section, particularly in

an urban area, since pollutants are dispersed from the bridge deck on a continuous basis and cannot be captured later for treatment.

Chapter 2 and Appendix A of this guide discuss the deposition and transport of pollutants on a bridge deck. Traffic movement and ambient wind constantly remove particulates from the roadway and deposit them in adjacent, low energy areas. In the case of a bridge, the adjacent area is the receiving water, and pollutants are deposited directly on the surface. In the case of a comparable terrestrial highway section, pollutants are deposited on the paved or unpaved shoulder areas and accumulate there until the next rain event, where they may be transported by the drainage system (absent treatment controls) to the receiving water. Treatment from roadside vegetation or other forms of terrestrial sequestration may remove deposited highway pollutants, which are forms of pollutant removal unavailable to runoff from a bridge deck. Thus, a portion of dry deposition to receiving waters from bridges cannot be effectively treated as in a comparable terrestrial highway system. To maximize environmental benefit, the practitioner should prioritize treatment of runoff from the bridge approach roadway, or at a similar location in the watershed, over treatment of runoff from the bridge deck.

## **BMP Selection Evaluation Tool**

This guide includes a spreadsheet-based BMP Selection Evaluation Tool (referred to as the tool) to assist the practitioner in evaluation and/or to optimize BMP selection if the practitioner will be installing treatment BMPs for bridge deck runoff. The tool allows the practitioner to maximize pollutant removal effectiveness while minimizing whole life costs for the given physical constraints. The tool may be used to compare BMP choices for treating runoff at a terrestrial highway section or treating runoff from the bridge deck at the abutment. The tool allows the practitioner to compare the cost advantages of all BMPs, the bridge deck conveyance system cost, as well as the treatment benefit that can be realized.

Tool inputs can be customized by the practitioner, including runoff influent quality and cost data for BMPs. The user also has the option to use the default data for these values, which will provide sufficient accuracy for the vast majority of department of transportation (DOT) projects.

---



## CHAPTER 1

## Overview

**1.1 Purpose**

The purpose of this guide is to assist the practitioner in assessing the need for and identifying the appropriate BMPs for stormwater runoff from bridge decks. The study focuses on bridge structures that cross a waterway and discharge runoff directly to the receiving water, though many of the measures discussed will be applicable to other bridge structures. Runoff from bridge decks is generally transferred directly to the receiving water via deck drains. This is because there is considerable expense to design, construct, and maintain a collection system to convey the runoff to the bridge abutment. The primary purpose to convey bridge deck runoff to the abutment is to facilitate the use of a land-based treatment BMP prior to discharge to the receiving water.

The EPA (1993) in its non-point source control guidance notes that,

... since bridge pavements are extensions of the connecting highway, runoff waters from bridge decks also deliver loadings of heavy metals, hydrocarbons, toxic substances, and deicing chemicals to surface waters as a result of discharge through scupper drains, with no overland buffering.

Much of the EPA guidance focuses on locating bridge crossings away from the most sensitive portions of the receiving water. However, the EPA also recommends consideration of diversion of bridge deck runoff to land for treatment; restricted use of scupper drains on bridges less than 400 feet in length and on bridges crossing very sensitive ecosystems; or a provision for equivalent urban runoff treatment in terms of pollutant load reduction elsewhere on the project or off-project to compensate for the loading discharged off the bridge. EPA indicates that the recommendations,

... have been found by EPA to be representative of the types of practices that can be applied successfully to achieve the management [for non-point source control] measure . . .

These recommendations stand in contrast to published research, which has not identified environmental impairment associated solely with either bridge runoff or where bridge runoff was a significant contributor to receiving water impairment. It is apparent that the EPA guidance for managing bridge deck runoff has been offered at a program level. This guide describes some of the available BMPs for bridge deck runoff and the conditions of their application that would both protect the environment and ensure the prudent expenditure of public funds.

The definition of maximum extent practicable, or MEP, is embodied as the basic performance standard in state and federal regulations, including the Federal Endangered Species Act and Sections 402 and 404 of the Federal Clean Water Act. The MEP standard does not necessarily involve the same criteria in each application; it is intended to address projects or actions on an individual basis considering each of their specific circumstances and purpose. The MEP standard for treatment of runoff from bridge decks is necessarily different from treating a standard highway section on land. This is because the cost of conveying bridge deck runoff to the abutment area is relatively high when compared to a standard highway section at grade, right-of-way at the abutment is limited, and the benefit of the BMP may be substantially less.

**1.2 Pollution Removal Benefit of the Treatment of Bridge Deck Runoff**

Assessment of water quality impacts of bridges generally focus on pollutants conveyed in stormwater runoff. An often overlooked issue is the transport and subsequent deposition of pollutants into receiving waters during dry weather (dry deposition). Dry deposition occurs when particulate matter that has accumulated on the bridge deck is re-suspended by vehicle and wind-induced turbulence and subsequently transferred directly into the receiving water below the bridge. Dry weather deposition occurs on all surfaces in all locations to varying degrees.

The flux of particulates (pollutants) deposited on the bridge surface and subsequently removed by vehicle-induced and natural wind currents is significant since displaced particles will be deposited directly on the receiving water during dry weather conditions. This directly deposited pollutant load is not available for subsequent treatment during a runoff event. This is in contrast to a comparable at-grade highway section where re-suspended particulates are captured in the highway shoulder area or along the adjacent right-of-way and either are sequestered in place or have the potential for treatment in a BMP within the highway conveyance system.

While further research is needed to understand the contribution to total pollutant loadings to receiving waters from vehicular and wind-driven re-suspension of pollutants, as compared with contributions of stormwater runoff, studies have quantified atmospheric deposition (bulk precipitation of particulates for both dry and wet weather) on bridge and highway sites, which provide insight into expected levels of dry deposition loading. Wu et al. (1998) indicates that the percentage of bulk precipitation in runoff for a bridge site (where previous retention could be ignored) was approximately 20% of total suspended solids (TSS) loadings, 70–90% of nitrogen loadings, and 10–50% of other constituents. Harrison and Wilson (1985) have indicated that rainfall can contribute to 48% of TSS and 78% of major ionic constituents (e.g., Na, Mg, Cl) in highway runoff. Therefore, it is likely that atmospheric deposition, especially on bridges where sequestration is minimal, has a significant influence on the amount of dry deposition loading to receiving waters. More research is needed on the quantification of bulk atmospheric deposition on bridges and adjacent receiving waters and how these relative pollutant loadings should influence stormwater runoff management decisions and the development of appropriate treatability goals for bridge runoff.

If treatment of bridge deck runoff is required, the physical processes that dominate pollutant deposition and re-suspension on roadways should be considered when determining the optimum location to construct treatment BMPs. The effectiveness of collecting and treating deck runoff is likely modest compared to treating runoff from an at-grade highway section with standard shoulders, particularly for bridge decks with narrow shoulders and locations that lack or have low railing walls.

### 1.3 Runoff Treatment Evaluation Strategy

The primary objective of this guide is to develop a procedure to determine what BMPs should be considered for bridges and when treatment BMPs are effective for bridge deck runoff. All bridge projects should consider source control BMPs that are applicable to the local conditions. This guide provides a discussion (in Chapter 4) of the various practices that should be

considered by the designer for new or retrofit bridge construction. Some recommendations may not be suitable for all cases, while others have more universal application.

Two general cases are presented for determining if treatment BMPs for bridge deck runoff are appropriate. The cases are differentiated according to the surrounding general land use, either rural or urbanized, which is consistent with the approach taken by EPA for implementation of the NPDES permit program. The practitioner is provided with a practical analysis method that is both protective of the environment and ensures stewardship of public funds. For the rural case, treatment of bridge deck runoff is generally not recommended since the impacts to the receiving stream are usually shown to be de minimis. The practitioner can verify this conclusion for an individual site using the simple assessment procedure discussed in Chapter 3. For urban areas, treatment of bridge deck runoff should be guided by the DOT Municipal Separate Storm Sewer System (MS4) permit or the states or federal agency Section 401 certification. The decision to apply treatment BMPs for a specific bridge project in an urban area (if required) should be evaluated from the perspective of providing the highest level of treatment for the least cost.

This guide provides a spreadsheet tool to assist the practitioner in documenting the BMP benefit and cost analysis for a bridge crossing in an urban area. The tool facilitates the computation of treatment BMP whole life cost and performance information as well as the whole life cost of a bridge deck drain collection system. This information can be quickly compared by the practitioner, for example, to an alternative land-based in-lieu treatment location to determine the treatment strategy with the least cost and highest benefit.

Figure 1-1 provides an overview of the recommended analysis process for any bridge project crossing waters of the United States.

*Step 1:* This guide can be used to develop bridge deck runoff mitigation at the environmental documentation stage. The environmental documentation will discuss if the project receiving water is a special classification, which would include outstanding national resource waters (ONRW), a domestic water supply reservoir, receiving water with endangered species or a receiving water with an active total maximum daily load (TMDL). Chapter 3 discusses analysis approaches for these types of receiving waters in more detail. The analysis approaches may be helpful in demonstrating whether the bridge deck will be a source of a pollutant of concern for the receiving water.

*Step 2:* All bridges should consider applicable stormwater and other source control and operation and maintenance practices, as described in Chapter 4. Source control BMPs include design and operational provisions to ensure that the bridge structure or traffic operations do not contribute

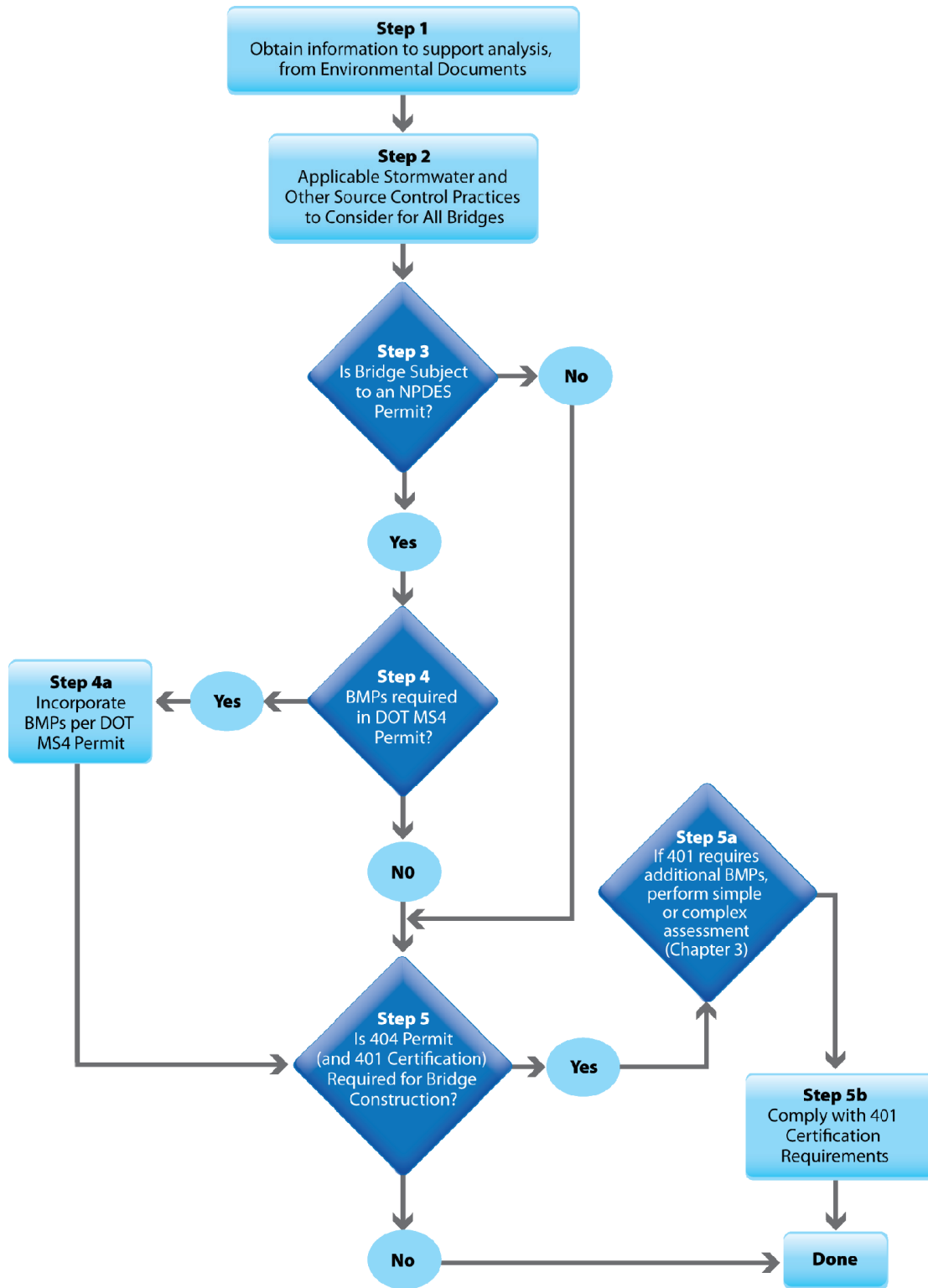

Figure 1-1. BMP flowchart.

pollutants to the receiving water during dry or wet weather to the extent practicable.

*Step 3:* Determine if the bridge is subject to an NPDES permit. Bridges not subject to an NPDES permit skip to Step 5; otherwise move to Step 4 to determine what BMPs are required by the DOT's MS4 Permit.

*Step 4:* Treatment requirements in the MS4 permit, if any, should be incorporated into the project. If none are required beyond those already incorporated in Steps 1 and 2, proceed to Step 5. If treatment is required by the DOT's NPDES permit, proceed to Step 4a. The least cost and highest benefit can be achieved by treating a comparable section of roadway (with similar annual average daily traffic [AADT], adjacent land use, and impervious area) rather than the bridge deck runoff. This is because the capital, operation, and maintenance cost of a deck collection and conveyance system is relatively high, and the benefits of treating deck runoff, as discussed in Section 1.2, may be comparatively less. The tool described in Chapter 6 can be used to document the cost basis for treatment at an off-site location. The off-site treatment location should be within the same watershed or upstream of the bridge crossing. The recommended approach follows the basic tenants of MEP to select the location and BMP with the least cost and highest environmental benefit.

*Step 5:* Determine if a 404 permit is required to construct or rehabilitate the bridge. Bridges that require a 404 permit will also require the companion 401 water quality certification. The 401 certification may contain requirements for treatment of deck runoff. The agency responsible for providing the 401 certification should be consulted early in the project development process to determine if BMPs beyond those described in Chapter 4, the project environmental document, or the DOT's MS4 permit (for crossings in urban areas) will be included in the 401 certification. If the resource agency is requiring BMPs beyond those in Chapter 4 or required as a part of the DOT's MS4 permit, it is recommended that a simple or complex assessment be performed to demonstrate that the bridge will not have impacts on the receiving water [40 CFR 230.10(a)(2)].

Chapter 3 provides assessment procedures the DOT can use to assist regulatory agencies in determining if runoff from a bridge crossing will have a significant impact on the receiving water. The assessment procedures can be used by the practitioner during the development of the project environmental documents, as well as during the project 401 process. They may also be helpful if the DOT MS4 permit is ambiguous regarding the application of BMPs to bridge crossings. The practitioner can apply the procedures to determine the environmental impact of the new or rehabilitated crossing on the receiving water. Two assessment methodologies are provided. The simplified method is appropriate for demonstrating the new or rehabilitated crossing will have a de minimis impact on the receiving water. This is accomplished through a basic computation of dilution, and showing that the change

in concentration of pollutants downstream of the crossing will not be significant or measureable.

A more sophisticated analysis may be required for crossings of domestic water supply reservoirs or in the case where endangered species are present. The complex assessment approach, also described in Chapter 3, can provide estimates of the concentration of a specific pollutant in the receiving water before and following project completion. The complex assessment method may be required when numeric values for a pollutant in the receiving water are needed.

## 1.4 BMP Selection and Evaluation

This guide promotes the use of source control and operation and maintenance BMPs for controlling the quality of bridge deck runoff as the basic measures that should be considered, as applicable, for all crossings. Treatment of an off-site at grade location is recommended in lieu of treating the actual deck runoff for bridges that require treatment in urban areas. If regulatory or receiving water conditions mandate treatment of the deck runoff, then a bridge deck drain collection system may be required to transport runoff to the abutment and the treatment BMP location. Use of a pervious friction course overlay is an on-deck treatment approach that can be considered as an alternative (see Chapter 5) that will not require a conveyance system.

The selection of the type of BMP for treatment of runoff either at the off-site in lieu location or at the bridge abutment is largely at the discretion of the designer. Several NCHRP publications can assist the designer in treatment BMP selection. Recent publications include, *NCHRP Report 565: Evaluation of Best Management Practices for Highway Runoff Control* and *NCHRP Report 728: Guidelines for Evaluating and Selecting Modifications to Existing Roadway Drainage Infrastructure to Improve Water Quality in Ultra Urban Areas*. Selection of the type of BMP will be driven largely by physical site constraints, since all of the BMPs described in these publications are targeted at constituents of concern for highways.

The spreadsheet tool (located on the TRB website) includes five treatment BMPs that have been proven effective for a conventional highway and are suitable for bridges. Four of these BMPs are for use at the bridge abutment and one can be used on the bridge deck:

At the abutment:

- Swales
- Dry detention basin
- Bioretention
- Sand filter

On the bridge deck:

- Permeable friction course (PFC)



These BMPs were selected for their performance, generally broad compatibility with physical site constraints and familiarity to and common use by DOTs. The practitioner is not constrained by these choices and other BMPs may be a better fit for site conditions. A separate study, in process at the time this guide was prepared, is “Long-Term Performance and Life-Cycle Costs of Stormwater Best Management Practices,” under NCHRP Project 25-40. This report provides an expanded list of BMPs for the practitioner to consider, as well as a tool similar to the one provided with this guide to evaluate BMP performance and whole life cost.

## 1.5 Organization of the Guide

This guide was developed to assist the practitioner in performing a maximum extent practicable analysis for stormwater treatment for a new or reconstructed bridge project crossing a water of the United States. Technical background and supporting information and examples are included in the Appendices, to reduce complexity and keep the guide focused on the recommended steps to complete the analysis. The remaining chapters of the guide are summarized as follows:

- **Chapter 2: State of the Practice** – This chapter identifies the current state of practice of assessment of the impacts of runoff from bridge decks on the receiving water, and provides an overview of regulatory requirements and current DOT practices. The purpose of this chapter is to orient the practitioner to the current standard of care for bridge deck runoff.
  - **Chapter 3: Assessment Procedure** – This chapter provides the practitioner with a stepwise approach to determine if bridge deck runoff will have a significant impact on receiving water quality. Two assessment procedures are described, a “simple” approach and a “complex” approach, depending on the objectives of the analysis to demonstrate a de minimis impact of bridge deck runoff on the receiving water, or to determine expected concentrations of pollutants of concern in the receiving water following bridge construction or reconstruction, respectively.
  - **Chapter 4: Stormwater Practices to Consider for All Bridges** – This chapter presents stormwater and other source control BMPs that should be considered for all bridges as appropriate, depending on the physical setting and type of bridge construction. Source control BMPs and maintenance practices to avoid or reduce loading of pollutants to the receiving water are described.
  - **Chapter 5: Stormwater Treatment Controls for Bridges** – In some instances in urban areas, or at sensitive receiving waters, treatment controls may be required. Whether constructed off-site to treat a conventional highway section on an in-lieu basis, or constructed at the bridge abutment to treat the deck runoff, this chapter provides an overview of treatment BMP options for the practitioner. An experimental practice developed as a part of NCHRP Project 25-32 is also described to treat runoff directly at the bridge deck drain. This chapter also discusses the probability of a spill on a bridge deck and considerations for spill containment countermeasures.
  - **Chapter 6: BMP Evaluation Tool** – This chapter provides a description of the use of the BMP selection evaluation tool. The basic functions of the tool and tool outputs are described. The user will also understand what portions of the tool default input values can be customized to more closely align with local conditions. A worked example with the tool is provided. A comprehensive worked example, following the flow chart (Figure 1-1), for the entire guide, is provided in Appendix B.
  - **References** – This section lists references cited in the text.
- The Guide also contains a number of appendices with additional reference information and examples to assist the practitioner. The contents of the appendices are:
- **Appendix A: Literature Review** – The literature review provides a summary of previous studies assessing the impact of bridge deck runoff on receiving water quality, as well as BMP applications at bridges. This appendix also contains the results of the DOT survey of nine agencies. The literature review found several applicable and contemporary studies that support the conclusions and recommendations developed in the guide.
  - **Appendix B: Simple and Complex Assessment Methods and Worked Example** – This appendix provides worked example calculations to aid the practitioner in completing “simple”; and “complex” assessments to determine the potential impact of bridge deck runoff on the receiving water. It also provides a comprehensive worked example problem using the entire procedure outlined in the guide.
  - **Appendix C: Quick Start Guide** – A quick start guide is provided for the practitioner that has completed the process previously and just needs a basic outline of the recommended procedure. The quick start guide is an abridged version of the steps the practitioner should complete to assess the appropriate BMPs for a bridge project.
  - **Appendix D: User’s Guide for the BMP Evaluation Tool** – This appendix contains a user’s manual for the spreadsheet tool.
  - **Appendix E: BMP Evaluation Tool Modeling Methodology** – This appendix provides the modeling methodology and underlying data for the spreadsheet tool.

## CHAPTER 2

# State of the Practice

This chapter describes the state of the practice for bridge deck runoff based on a literature review and DOT survey. It gives a general overview on how and when DOTs are conveying and treating runoff from bridge decks, and discusses the mechanisms for pollution discharge from bridge decks. It provides a state of the practice for mitigation of bridge deck runoff water quality.

The first section gives an overview of BMPs used for bridge deck runoff, including source control and treatment BMPs. The second section discusses the regulatory requirements as they pertain to runoff from bridges. Clean Water Act regulatory programs are generally delegated to the states for implementation and enforcement (the EPA is responsible for NPDES permitting in the non-delegated states of Idaho, Massachusetts, New Hampshire, and New Mexico, as well as in U.S. territories, tribal lands, and the District of Columbia) and states may have their own environmental laws for stormwater runoff. Accordingly, the regulatory programs are discussed in general. The practitioner must contact the state environmental agency or EPA, as appropriate, for jurisdiction specific requirements.

The final section of this chapter discusses the impact of bridge deck runoff on receiving waters. This discussion is based on several recent studies investigating the potential for receiving water impairments from stormwater runoff from bridge decks. In general, bridges in rural areas will have no significant impact on receiving water quality and should implement the applicable source control BMPs discussed in Chapter 4. Bridges in urban areas have the potential to contribute to impairment of beneficial uses and, if treatment controls are determined to be required, the BMPs described in Chapter 5 and the Tool described in Chapter 6 can help the practitioner determine the optimum BMP type and treatment location.

### 2.1 State of the Practice for Bridge Stormwater Management

This section describes the current state of the practice for bridge deck runoff management and BMP application. The information in this section is based on the findings from the

literature review and DOT survey. This information can assist the practitioner in determining what is considered the current standard of care and practicable by other DOTs.

#### 2.1.1 Systems for Bridge Deck Runoff Capture

*NCHRP Report 474, Volume 1* identified bridge deck runoff practices for bridges crossing receiving waters as follows.

- Discharging runoff through multiple open scuppers directly into the receiving water.
- Discharging runoff through piping down from the bridge deck along or through the columns or piers directly into the receiving water without treatment.
- Conveying the stormwater runoff over the surface of the bridge to one or both abutments for discharge or treatment by a BMP.
- Detaining and treating the stormwater under the bridge deck where overbank areas are available.
- Conveying the stormwater runoff via piping or open gutters over to one or both abutments for BMP treatment or discharge.

Bridge deck runoff conveyance systems, whether taking the form of piping to the receiving water, to the abutment, or by conveyance of runoff on the bridge deck, are generally more expensive than conveyance on a standard at-grade roadway section. Deck drainage systems have the following potential technical design issues that can increase design, construction, and O&M costs for the bridge:

- Longitudinal slope on bridges can be very low, requiring increased pipe size or increased deck area in the shoulder to convey runoff;
- Deck drain and pipe systems are prone to clogging and/or freezing due to relatively small conveyance areas;

- Pipe joints must have sufficient flexibility to move consistent with the allowable expansion of the bridge joint;
- Pipe systems may not be compatible with the aesthetics of the bridge;
- The additional weight of the pipe system may require a larger bridge cross section;
- Deck drain or scupper maintenance is hazardous and may interrupt traffic flow due to limited shoulder area to work; and
- Pipe materials can corrode and leak.

By contrast, conventional roadway cross sections generally have a relatively wide shoulder for safety and conveyance of flow. Longitudinal and/or cross culvert systems are also generally available to collect roadway runoff or the flow can be dispersed in the right-of-way or conveyed in open vegetated systems to receiving waters.

There are few published references on the state-of-the-art for bridge deck runoff mitigation for water quality. The most complete reference is based on surveys of DOTs as a part of *NCHRP Report 474, Volume 2* (2002). *NCHRP Report 474, Volume 2* gives an excellent summary on the state of the practice for bridge deck runoff mitigation practices. Other published literature focuses on the practicability of treatment BMPs for bridges and source controls applicable to bridges, such as the study completed by the North Carolina DOT (URS 2010).

The DOT survey described in *NCHRP Report 474, Volume 2* included a question on whether DOTs treat runoff from bridge decks. Of the 50 states surveyed, 16 responded that they had built or planned to build a structural mitigation system for bridge deck runoff. The reasons given (with number of times the response was noted in parentheses) for the structural mitigation system included:

- Requirement of a watershed plan (2)
- Potential for hazardous materials spills (3)
- Pressure from environmental group (3)
- 401 or Coastal Zone Act Reauthorization Amendments (CZARA) requirement (3)
- Sensitive receiving water – municipal supply (4)
- Endangered species in receiving water (2)
- NPDES permit conditions (1)
- Outstanding national resource water (3)

The DOT survey completed to support this guide was not as comprehensive as the one previously performed for *NCHRP Report 474, Volume 2*; however, it was developed as a companion effort by gathering similar information to determine if the state of the practice had progressed significantly in the

11-year period since the previous survey was published. Nine DOTs were surveyed as a part of the update for this guide:

- Florida DOT (FDOT)
- Massachusetts DOT (MassDOT)
- Louisiana Department of Transportation Development (LADOTD)
- Maryland State Highway Administration (MDSHA)
- Nebraska Department of Roads (NDOR)
- North Carolina Department of Transportation (NCDOT)
- South Carolina Department of Transportation (SCDOT)
- Texas Department of Transportation (TxDOT)
- Washington State Department of Transportation (WSDOT)

A discussion of the results of the survey update follows and shows that the concerns and current practice as identified in the *NCHRP Report 474, Volume 2* survey remain relatively unchanged, with a general preference by DOTs not to install bridge deck treatment and conveyance systems due to their high capital and operation and maintenance cost compared to the apparent benefit.

### 2.1.2 DOT Runoff Management Strategies for Bridges: Highlights from Interviews

Most DOTs surveyed discharge deck runoff through scuppers (horizontal openings in the railing wall) to the receiving water. This type of design approach is the most cost effective and has the least maintenance cost over the life of the facility. Alternatives to the approach are used when the bridge crosses sensitive receiving waters, and the environmental document or resource agency permit requires some form of deck runoff treatment.

FDOT uses a simple four-step progressive process for evaluation of options.

- Drain on the deck shoulder to a storm drain system at the abutment.
- Direct discharge to receiving water.
- Compensatory treatment at an offsite location.
- Closed conduit collection system.

Other DOTs (e.g., LADOTD, MassDOT) had no special or additional designs beyond the standard guidelines provided in FHWA Hydraulic Engineering Circular No. 21, or the state's stormwater handbook. States emphasized that design approaches were developed on a site-by-site basis because of requirements in the environmental documentation process, and what was considered MEP treatment for the site. MDSHA does not apply different treatment standards to bridges as compared to any other section of

highway. In one case, MDSHA raised the lip height of scuppers to avoid direct discharge of the first flush. If possible, MDSHA does not use scuppers and conveys runoff to the abutment if it is technically feasible without increasing the required deck area. MDSHA generally treats an equal amount of impervious highway surface at an offsite location in lieu of treating deck runoff, if the bridge crosses environmentally sensitive waters.

General bridge deck runoff handling strategies for crossings over sensitive receiving waters were focused on “moving the runoff off of the bridge if possible and treating it in upland areas at the approaches.” As WSDOT indicated, “Just getting deck runoff to a treatment site can be a significant technical problem; there is not a lot of hydraulic head available.” Force mains or pumping off bridges (non-gravity dependent approaches) were not considered MEP or sustainable solutions.

The MassDOT noted that, “options for bridge deck runoff treatment are few” and “success in piping deck runoff” is better on shorter spans (Barbaro 2012). Thus, MEP is different for bridges than it is for conventional roadway sections.

The LADOTD conveys and treats runoff from only one (1) bridge site at this time, a case in which a bridge crosses a sensitive water body and drinking water supply (Harris 2013). The TxDOT and MassDOT also referenced the importance of drinking water supplies and treatment of deck runoff in those areas (Barbaro 2012) (Foster 2012).

### 2.1.3 Considerations and Limitations of Conveyance and Treatment as Identified by DOTs

DOTs identified the following considerations related to runoff mitigation strategies during personal interviews.

- **Resource agency requirements/specifications.** Nearly every DOT indicated that the design and operational difficulties with bridge conveyance systems are such that bridge runoff tends only to be treated if resource agencies specifically require it. For example, the NDOR will treat bridge runoff, “when it is requested by Game & Parks/Fish and Wildlife Service following project consultation.” Likewise, the LADOTD treats runoff, “in accordance with resource agency permit.” TxDOT also indicated it treats bridge deck runoff only if there is a regulatory requirement to do so; “typically, this is tied to 401 certification of very large Individual 404 permits (more than 1,000 linear feet or 3 acres of impact to waters of the United States), a rare event.” In North Carolina, the decision to treat deck runoff is based on specific considerations, such as water quality classifications of the waters to which the bridge discharges, Endangered

Species Act issues, and on whether the bridge is being newly constructed and has physical attributes that facilitate treatment. Other regulations that potentially drive treatment for NCDOT include the Clean Water Act 401 certifications and state regulations on nutrient-sensitive waters.

- **Pipe size limitations.** Some DOTs (e.g., FDOT, WSDOT) will pipe stormwater off bridge decks if required by a regulatory agency; however, girder size can constrain the size of the pipes that can be used. For example, the DOT could only convey about 91% of the 2-year storm in the sample case provided.
- **Maximum spread.** Some bridge projects can accommodate runoff in the shoulder and convey it to the abutment without widening the deck; however, if runoff spreads into the travel lane, it increases hydroplaning potential and risk of accidents. On long flat bridges, the spread tends to expand rapidly.
- **Gutters.** Some DOTs have been successful in using a gutter system, draining to the abutment for treatment. Research in North Carolina suggested that gutters might be implicated in the concentrating of pollutants.

Nearly all DOTs contacted said that treatment for new construction projects is determined on a project-by-project basis with resource and regulatory agencies as part of the project-planning phase. Where states consider retrofit measures, those may be selected and designed through the DOT’s Highway Stormwater Retrofit Program to meet site-specific water quality goals (NCDOT 2008).

NCDOT avoids direct discharge off bridge decks and, whenever possible, they try to discharge to the overbank and collect and convey the stormwater to the stream in a manner that does not cause erosion. On lower ADT secondary bridges, NCDOT is replacing the structures if needed and not adding stormwater treatment mechanisms. Level spreaders and energy dissipaters in the overbank area are the most common method to minimize erosion. Additional treatment is provided in consultation with regulatory agencies. Nearly all of the DOTs contacted are dealing with bridge deck runoff on a case-by-case basis. Treatment of bridge deck runoff is far from standard, due to the technical difficulties of conveyance and treatment, and the relative benefit that treatment can produce as compared to other locations in the highway system.

### 2.1.4 Source Control Approaches

Street sweeping, catch basin and scupper cleaning, deck drain cleaning, deicing controls or changes to deicing methods, snow management, traffic management, and management of maintenance activities were all cited by DOTs as options to improve bridge deck runoff water quality.



Reduced salt usage is one of the best source control actions a DOT can take in areas where receiving water hardness is problematic and salt is applied for deicing. For example, Caltrans implemented a reduced salt-use policy that requires their districts to develop specific route-by-route plans (NCHRP 2004). The policy mandates that:

Snow removal and ice control should be performed as necessary in order to facilitate the movement and safety of public traffic and should be done in accordance with best management practices with particular emphasis given to environmentally sensitive areas (NCHRP 2004).

During the first winter of implementation, Caltrans reduced salt usage by 62% statewide as compared to the previous winter, helped by improved control of the application frequency of deicing salt (Caltrans 2004).

Street sweeping is one of the most common source control approaches in MS4s and some states are considering applying this measure to bridges. The benefits of sweeping are difficult to discern in outfall water quality. The direct benefit to stormwater quality or effect on receiving waters of this sediment removal has not been conclusively defined. This may be because the build-up of material on roadways occurs relatively frequently and rapidly reaches a relative equilibrium where material is transported to the shoulder areas by wind energy. NCDOT (2010) states,

Additional investigation is needed to establish the effectiveness of bridge sweeping as a BMP (BMP for stormwater) and to provide potential improvements to existing sweeping practices to benefit stormwater quality. NCDOT conducts sweeping practices for many existing bridges throughout the state because of the associated maintenance and safety benefits . . . NCDOT does not currently conduct bridge sweeping to specifically address stormwater quality concerns; . . . (however), because of the potential to remove sediment, bridge sweeping should continue to be considered as a potential water quality treatment BMP for bridge decks. Other DOTs are reviewing bridge sweeping as a viable alternative for stormwater treatment of deck runoff, particularly when other methods of treatment are not feasible or are cost-prohibitive. In addition, potential improvements to existing sweeping practices should be considered, including equipment upgrades and training for sweeper speed and maintenance. Additional study is recommended to further evaluate sweeping as a BMP and to shape sweeping practices (including frequency, type of equipment, and disposal practices) to maximize the benefit for stormwater quality (NCDOT and URS 2010).

NCDOT has used sweeping as a negotiated stormwater control measure. For example, on Currituck Bridge, it was not possible to install a collection system for technical reasons. The regulatory agency agreed that sweeping was an acceptable measure, performed through a public private partnership (PPP).

Other state transportation agencies, such as MDSHA, are working on strategies to increase the sweeping frequency on

bridge decks. The anti-icing material is needed on the roadway November to April (when rain might freeze), so sweeping during this season is not required. Currently, MDSHA is working to optimize the sweeping frequency for bridge decks outside of the period when deicers and traction aides are used.

MDSHA is also required to report the pounds of sediment collected by sweeping by watershed. This can be difficult to accomplish since sweeper routes are not dictated by watershed boundaries. MDSHA supports highway sweeping but at a different frequency than the regulatory agency would prefer. More definitive study on the frequency of sweeping for bridge decks would be beneficial. Where sweeping is found to be practical and beneficial to deal with particulates, new high-efficiency street sweeping machines may be economical in urbanized areas.

DOTs have shared a number of other source control practices that include the following:

- “Smart” in-vehicle application technology involving GPS and electronic sensing might make it feasible to use special deicers on bridges or not use them at all, depending on the environmental variables.
- Reviewing deicing practices with respect to bridges.
- High efficiency catch basin cleaning is being considered along with high efficiency sweeping in some states.
- PFC and/or open graded friction course (OGFC) pavement. TxDOT and NCDOT have invested in research on the water quality benefits of PFC and/or OGFC pavement. Data from North Carolina indicated that the water quality benefits last as long as the structural life of the pavement, even though no maintenance at all was performed. NCDOT confirmed that as long as the road has speeds over 45 mph, pavement maintenance for PFC could be avoided without a loss of permeability in the overlay. NCDOT has a current PFC research project underway. WSDOT indicated they would consider OGFC as a wearing course, but OGFC “gets damaged with studded tires.” MassDOT indicated they are pursuing BMP credit for the considerable quantity of OGFC the state is using.
- Bio-sorption activated media are being explored by Florida researchers for filtration in the deck drain. This technology is already in use, in greater quantities, in roadside BMPs.

Some DOTs confine source control to DOT operations only. For example, during construction and maintenance projects, LADOTD limits materials placed on bridges to only that necessary, with special attention to cleaning materials, solvents, and/or fuels. Only non-phosphate solutions are allowed for cleaning bridge structures. During de-icing events, minimum amounts of de-icing agents are used. MassDOT no longer places sand on bridges and many DOTs have dramatically reduced sand usage, for both air and water quality purposes.

Other DOTs are contemplating how vehicle sources could be better controlled, outside of reducing vehicle spray through greater use of PFC. For example, NCDOT is interested in determining if rumble strips prior to the bridge deck could shake off pollutants from the undercarriage of vehicles, to minimize the pollutants that are being carried onto bridges and being sprayed off splash, during precipitation events or are deposited during dry weather. Engineers have noticed concentrations of oil and grease where there are irregularities in the roadway surface. BMPs along the approach sections could be used to treat runoff from the area's tributary from rumble strips. This idea has been carried forward in the research needs portion of this project.

### 2.1.5 Other Strategies

Treatment at bridge approaches may include detention ponds, grass swales, or buffers; however, treatment at bridge approaches is not always feasible. For example, MDSHA noted that treatment near the bridge approach is infeasible in certain areas due to the extent of the 100-year floodplain and wetland regulation. In low-lying coastal areas, the floodplain may be wide and wetlands extensive in the area of the bridge project, in addition to the difficulties with draining water on long, flat bridges. In such cases, off-site mitigation is considered. Stream buffer regulations can also restrict a DOT's ability to treat stormwater at bridge approaches. NCDOT cited instances of buffer regulations where NCDOT, "can't discharge into Zone 1 (30 feet) and in some cases Zone 2 adjacent to the receiving water."

Two state DOTs interviewed (WSDOT and SCDOT) said they were treating bridge deck runoff in a vault. WSDOT completed a project in Riverton, WA, where they used infiltration vaults to treat and infiltrate runoff from the bridge in the abutment area.

In a case over a shellfish area and Outstanding Resource Water (ORW), SCDOT has a closed system and Stormceptor® device treating drainage from one direction (the other could be piped to an upland detention site); however, SCDOT indicated that the closed system approach, "isn't very practical. Stormceptors are only modestly effective in treating for sanitary quality."

Consideration of off-site mitigation options is becoming a standard part of the bridge deck runoff evaluation process in Florida and Maryland. South Carolina is, "developing a criteria based on surface area of the bridge."

- Maryland SHA and the Maryland Department of Environment established a water quality bank that allows for permitting highway projects that cannot meet all stormwater water quality requirements. The water quality credit is established through off-site mitigation at the 6-digit HUC watershed level and the currency is acres of impervious

surface treated. The positive balance in the bank is kept by implementation of various water quality projects designed to treat unmanaged impervious surfaces.

- FDOT tries to collaborate with co-permittees and "pay for off-site improvements." FDOT is taking advantage of the current political environment to press for off-site treatment; last year, the state legislature passed a bill mandating that the state regulatory community allow flexible treatment approaches for transportation. That bill specifically named watershed level treatment and other strategies.

South Carolina DOT is performing modeling to understand the impacts of bridge deck runoff, as is TxDOT. TxDOT has an ongoing project entitled, "Contribution of Bridge Dwelling Birds to Bacterial Water Quality Impairments."

## 2.2 Overview of Regulatory Requirements

### 2.2.1 NPDES Permits

Section 402 of the Clean Water Act (CWA) requires operators of MS4 to obtain coverage under the NPDES permit program to discharge stormwater runoff to waters of the United States; DOTs must obtain Permit coverage for their systems. Permitting details vary from state to state, including the geographic extent of required coverage and the type of NPDES permit issued to the DOT. The 2010 NCHRP Project 25-25(56) report, "Cost and Benefit of Transportation Specific MS4 and Construction Permitting," provides an excellent discussion of the NPDES permitting program and its application to DOTs.

The NPDES program was implemented by the EPA in two phases. Phase I permits were issued starting in 1990 and Phase II permits were issued starting in 2003. The Phase I program applies to urban areas with populations greater than 100,000. The Phase II program generally applies to urban areas with populations greater than 10,000.

NPDES permits may be issued individually or collectively to two or more permittees. The geographic coverage area of the permit generally falls within the census areas for populations defined as urbanized, although the permitting authority may designate other areas if they are deemed a threat to receiving water quality. NPDES permits are also issued for industrial facilities. Industrial facilities include construction sites. Industrial permits are usually issued by the permit authority on a statewide basis, applicable to specified industry classifications.

A DOT may be covered by an NPDES permit in a variety of ways. The alternatives are:

- Phase I individual permit coverage for all DOT facilities or only those in urbanized areas.
- Phase I individual permit coverage that includes industrial facilities and construction sites for all facilities statewide.

- Phase I permit coverage as a co-permittee with other Phase I entities, only in Phase I coverage areas.
- Phase II individual permit coverage for all DOT facilities.
- Phase II permit as a co-permittee only in Phase I and Phase II coverage areas.

Phase I and Phase II permits have modestly different requirements. Phase I permits pre-date the Phase II permits and generally have more stringent requirements, particularly with respect to monitoring and sampling. The requirements of Phase II permits reflect the more limited resources of smaller cities and capitalize on the information gained through the Phase I program to simplify implementation, monitoring, and reporting.

Most Phase I and Phase II permits have provisions for new construction and reconstruction projects, as well as for operation and maintenance of highway facilities. These permit sections are of interest to the practitioner when determining BMP requirements for a new or reconstructed bridge. The permit requirements are generally translated into design guidance in the form of a handbook or manual by the DOT.

## 2.2.2 Wetland Permitting

Section 404 of the CWA requires entities that wish to discharge fill material or to dredge material from waters of the United States to obtain a permit. Bridge construction nearly always requires a Section 404 permit, issued by the USACE, unless the bridge will span the jurisdictional area, and there will be no temporary impacts (e.g., cofferdam construction or falsework) within the jurisdictional area. This is rarely the case, and obtaining a 404 permit for bridge construction is routine. The USACE will consult with the Department and Fish and Wildlife and the National Marine Fisheries service as appropriate in developing the 404 permit. Section 401 of the CWA requires the State to certify that the dredge or fill operation permitted under Section 404 will not adversely affect the receiving water beneficial uses. The Section 401 certification may contain requirements for the DOT to construct and maintain BMPs (source controls and treatment controls, both during construction and post-construction) to ensure protection of receiving water beneficial uses.

Waters of the United States include essentially all surface waters such as all navigable waters and their tributaries, all interstate waters and their tributaries, all wetlands adjacent to these waters, and all impoundments of these waters.

The waters of the United States include

- (1) All waters which are currently used, or were used in the past, or may be susceptible to use in interstate or foreign commerce, including all waters that are subject to the ebb and flow of the tide;
- (2) All interstate waters including interstate wetlands;

- (3) All other waters such as intrastate lakes, rivers, streams (including intermittent streams), mudflats, sandflats, wetlands, sloughs, prairie potholes, wet meadows, playa lakes, or natural ponds, the use, degradation or destruction of which could affect interstate or foreign commerce including any such waters:
  - (i) Which are or could be used by interstate or foreign travelers for recreational or other purposes; or
  - (ii) From which fish or shellfish are or could be taken and sold in interstate or foreign commerce; or
  - (iii) Which are used or could be used for industrial purposes by industries in interstate commerce;
- (4) All impoundments of waters otherwise defined as waters of the United States under this definition;
- (5) Tributaries of waters identified in paragraphs (1)-(4);
- (6) The territorial seas; and
- (7) Wetlands adjacent to waters (other than waters that are themselves wetland) identified in paragraphs (1)-(6).

The lateral limits of jurisdiction of waters may be divided into three categories: the territorial seas, tidal waters, and non-tidal waters (see 33 CFR 328.4 (a), (b), and (c), respectively). More specifically, CFR 328.3(a) provides the following clear definition of waters of the United States:

Waste treatment systems constructed in upland areas, including treatment ponds or lagoons designed to meet the requirements of the CWA (other than cooling ponds as defined in 40 CFR § 123.11(m) which also meet the criteria of this definition) are not waters of the US 33 CFR § 328.3(a); 40 CFR § 230.3(s).

Adjacent wetlands subject to CWA Section 404 jurisdictions are those that are bordering, contiguous, or neighboring to other waters of the United States. Frequently, the term “wetlands and other waters of the United States” is used when describing areas under USACE jurisdiction.

For the regulatory process, the USACE and EPA jointly define wetlands as follows:

Those areas that are inundated or saturated by surface or ground water at a frequency and duration sufficient to support, and that under normal circumstances do support, a prevalence of vegetation typically adapted for life in saturated soil conditions. Wetlands generally include swamps, marshes, bogs, and similar areas (EPA, 40 CFR 230.3 and USACE, 33 CFR 328.3).

The USACE is primarily responsible for implementing the CWA Section 404 program. Section 404 of the CWA establishes a permit program administered by USACE that regulates the discharge of dredged or fill material into waters of the U.S. Section 404(b)(1) guidelines allow the discharge of dredged or fill material into the aquatic system only if there is no practicable alternative that would have less adverse effects.

The purpose of the Section 404 program is to ensure that the physical, biological, and chemical quality of our nation’s water



is protected from irresponsible and unregulated discharges of dredged or fill material that could permanently alter or destroy these valuable resources. The USACE Regulatory Program administers and enforces Section 10 of the Rivers and Harbors Act of 1899 and Section 404 of the CWA. Under the Rivers and Harbors Act, Section 10, a permit is required for work or structures in, over or under navigable waters of the United States. Under CWA, Section 404, a permit is required for the discharge of dredged or fill material into waters of the United States. The USACE regulatory authority under the Rivers and Harbors Act of 1899 is limited to traditional “navigable waters.” Traditional navigable waters regulated by Section 10 are waters that are, could be, or were once used to transport interstate or foreign commerce. In contrast, “waters of the US” regulated under Section 404 also include “other waters” such as wetlands that have a sufficient nexus to interstate commerce. In practice, USACE regulatory authority under the Rivers and Harbors Act has been integrated with regulatory authority under the CWA, and USACE uses one permit application for both types of permits.

Figure 2-1 illustrates the USACE lateral extent of jurisdiction under Section 10 and Section 404.

### 2.2.3 CWA Section 401 Water Quality Certification

Although a federal regulation, 401 Water Quality Certification is largely issued by individual states, typically by their water quality or environmental departments. Over the past several years, states have generally expanded the application of Section 401 certification to waters and wetlands. Some states rely on

Section 401 certification as their primary mechanism to protect wetlands in the state. In addition, most states denied certification of some nationwide permits because they believe that individual review of projects in isolated and headwater wetlands is critical to achieving CWA goals in their states. States have also increased their regulatory authority as the USACE’s jurisdiction has decreased due to recent U.S. Supreme Court cases.

Overall, Section 401 certification allows states to address associated chemical, physical, and biological impacts such as low dissolved oxygen levels, turbidity, inundation of habitat, stream volumes and fluctuations, filling of habitat, impacts on fish migration, and loss of aquatic species because of habitat alterations or the deposit of dredge or fill material.

## 2.3 Evaluation of Receiving Water Impacts

As owners of state highways and bridges, DOTs are interested in discerning whether contamination of water bodies from roads and bridges is significant, and, if so, what mitigation is appropriate. The purpose of this section of the guide is to summarize the published information on bridge runoff quality and its impacts on receiving waters.

### 2.3.1 Bridge Deck Runoff Quality

Several studies have been undertaken to evaluate whether bridge deck and roadway runoff quality were significantly different. The most comprehensive study to date was conducted by URS Corp. for NCDOT. The URS study (2010) found “no

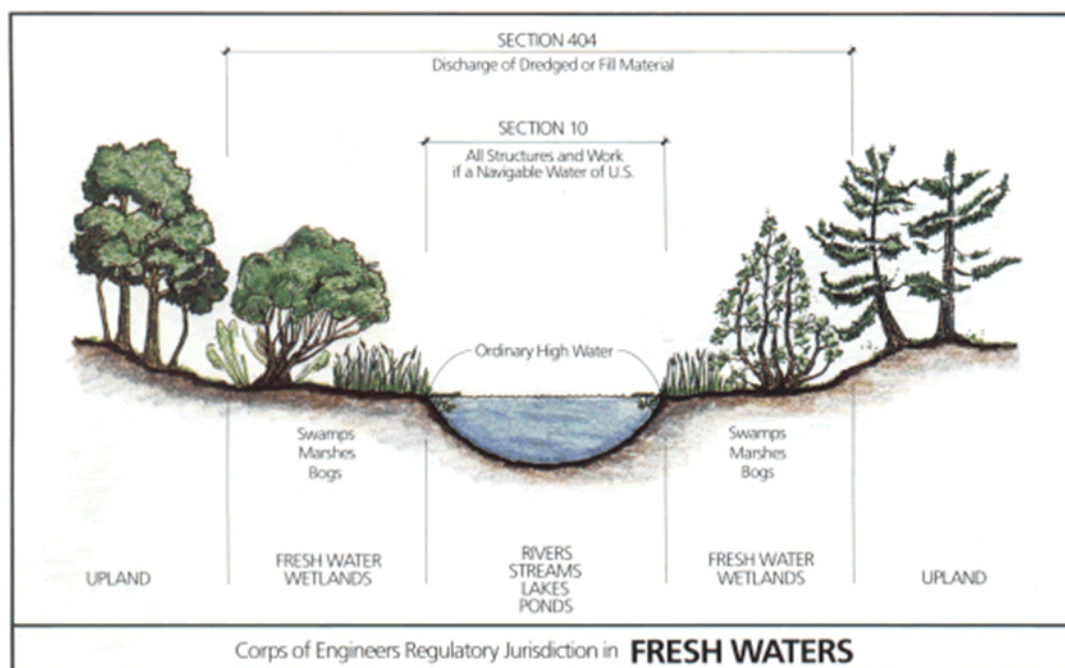

Figure 2-1. USACE regulatory jurisdiction in fresh waters.

compelling evidence that bridge deck runoff in North Carolina is higher in pollutants typically associated with stormwater runoff as compared to runoff from other roadways.” Of all the characteristics investigated by URS, the urban versus rural designation appears to have the most influence on pollutant loading. All solids parameters studied were higher in urban areas, as well as most total recoverable metals and dissolved copper and lead.

In a study funded by TxDOT, Malina et al. (2005) also showed that bridge deck runoff is generally not statistically different from highway runoff. In a comparison of bridge deck runoff event mean concentrations (EMCs) to the approach highway EMCs, there were only limited instances when parameters were significantly different from each other. Malina et al. concluded that highway runoff data could be used as a conservative approximation of bridge deck runoff quality. Malina et al. also found that loading of all measured water quality constituents was minimal, with “no substantial adverse impact to the receiving streams . . . observed or indicated by bridge deck runoff from the three monitored sites.” Loadings from upstream sources were several orders of magnitude greater as compared to the loading from the bridge deck.

As Nwaneshiudu (2004) and others have pointed out, “Most of the pollution found in highway runoff is both directly and indirectly contributed by vehicles. The constituents that contribute the majority of the pollution, such as metals, chemical oxygen demand, oil and grease, are generally deposited on the highways.” Consequently, roadway runoff water quality data should be used as an approximation for the pollutant profile of bridge deck runoff (Dupuis et al., 2002).

As part of this project, the National Stormwater Quality Database (NSQD, version 1.1) and the FHWA database were analyzed to determine typical constituent concentrations in highway runoff. The results of this analysis are presented in Table 2-1 with the column titled “All Data” showing the median for all available data regardless of traffic volume. It is clear from looking at the data that the concentrations of pollutants associated with vehicles, such as TSS, total copper, and total zinc, are correlated with AADT.

*NCHRP Report 474* reviewed scientific and technical literature addressing bridge deck runoff and highway runoff performed by FHWA, USGS, state DOTs, and universities, focusing on the identification and quantification of pollutants in bridge deck runoff and how to identify the impacts of bridge deck runoff pollutants to receiving waters using a weight-of-evidence approach. Although undiluted highway runoff can exceed federal and state ambient water quality criteria, this alone does not automatically result in negative effects to receiving waters. Dupuis et al. found no clear link between bridge deck runoff and biological impairment in the receiving water, though noted that salt from deicing could be a concern.

### 2.3.2 Receiving Water Studies

In the meta-analysis of existing studies, Dupuis et al. showed that while several studies had shown direct drainage to some types of receiving waters (e.g., small lakes) could cause localized increases in certain pollutant concentrations, most studies did not consider whether such increases adversely

**Table 2-1. Median concentrations of typical highway runoff constituents.**

Constituent	Annual Average Daily Traffic				
	0 – 25K	25K – 50K	50K – 100K	100K +	All Data
TSS (mg/L)	43	56	94	108	79
NO <sub>2</sub> +NO <sub>3</sub> (mg/L)	0.385	0.61	0.62	0.805	0.64
NO <sub>3</sub> (mg/L)	0.2	0.83	0.6	1.1	0.6
TN (mg/L)	1.44	4.69	2.57	2.725	2.64
TKN (mg/L)	0.84	1.794	1.7	2.1	1.6
DP (mg/L)	0.072	0.105	0.0745	0.17	0.09
TP (mg/L)	0.12	0.16	0.2	0.237	0.2
T Cu (µg/L)	9.3	20	32	50	24
T Pb (µg/L)	6.6	12.7	74	46	32
T Zn (µg/L)	60	93	180	270	130
Fecal Coliform (#/100 ml)	5000	NA	4150	1700	50
E. Coli (#/100 ml)	NA	NA	NA	NA	1900

affected the biota or other receiving water uses. In addition, the study did not consider whether observed increases could be attributed at least partially to dry deposition. The only comprehensive study of bridge runoff at that time, FHWA's I-94/Lower Nemahbin Lake site, found that although direct scupper drainage increased metals concentrations in near-scupper surficial sediments, biosurveys and in situ bioassays found no significant adverse effects on aquatic biota near the scuppers. FHWA concluded that for lower traffic volume bridges at least, runoff had a negligible impact on receiving waters (Dupuis et al. 1985a).

Dupuis (2002) also reported that the results of bioassay testing using whole effluent toxicity from various studies have been mixed. For the studies that do show some level of toxicity, the runoff samples were high in salt content from deicing activities. However, the bioassay methods used by these studies may not be appropriate for evaluating stormwater runoff. Most bioassays expose the organism being tested continuously to runoff for long periods. However, stormwater runoff is delivered to receiving streams in short, intermittent time frames.

URS (2010) completed a comprehensive study of bridge deck runoff for the NCDOT. In this study, the authors note that, "The effects of stormwater runoff on aquatic biota need to be evaluated across different time scales," and they refined a time-variable bioassay procedure to reflect the conditions found during runoff events from bridges. The original application of time-variable bioassay approach for bridges appears to have been conducted as a part of *NCHRP Report 474: Assessing the Impacts of Bridge Deck Runoff Contaminants in Receiving Waters*.

The NCDOT study (URS 2010) (1) quantified the constituents in stormwater runoff from bridges across the state, (2) evaluated the treatment practices that can be used to reduce constituent loadings to surface waters from bridges, and (3) determined the effectiveness of the evaluated treatment practices. NCDOT summarized conclusions from previous studies:

- Pollutant loadings from bridge decks to a receiving stream are minimal when compared to pollutant loadings from other watershed sources.
- Specific instances of elevated parameters, particularly zinc, may be linked to galvanized bridge materials.
- While several parameters-of-concern from bridge deck runoff exceeded site-specific surface water quality thresholds, the analyses associated with aquatic toxicity, biological assessments, and sediment data did not indicate long-term adverse impacts from untreated bridge deck discharges.
- Deicing activities and pollutant accumulation in sediment are potential sources of localized toxicity that require further study.

NCDOT concluded that these observations

... support the concept that surface water quality protection may be better served by managing stormwater runoff on a watershed scale as opposed to focusing management efforts specifically on bridges. In addition, there may be opportunities to improve water quality by identifying and controlling the source of pollutants (e.g., by replacing certain bridge materials).

NCDOT also developed a treatment scheme and estimated costs.

In the study for NCDOT, URS (2010) found no statistically significant differences in sediment pollutant concentrations upstream and downstream of the bridge, for either bridges that do not directly discharge to receiving water or direct discharge bridges. Overall, the URS analysis of streambed sediment did not indicate any impacts of bridge deck runoff on sediment quality. Ecoregional differences were observed for some analytes but these differences appeared to be associated with naturally occurring conditions or upstream anthropogenic influences. Furthermore, where sediment quality benchmarks were exceeded, except for lead and mercury, the exceedances were found to be independent of the discharge drainage design from the bridge (i.e., direct versus indirect) and also were found to occur either upstream of the bridge deck, or at similar levels upstream and downstream, indicating sources other than bridge deck runoff.

Bartelt-Hunt et al. (2012) investigated the impacts of bridge runoff and receiving water quality at four bridges in Nebraska for NDOR. The objectives of this research were to evaluate the quality of bridge deck runoff; to determine the effects of bridge deck runoff on surface water bodies in Nebraska by evaluating water and sediment chemistry; and to evaluate the effects of bridge deck runoff on aquatic life. The goal was to identify the potential environmental impacts of bridge deck runoff on receiving streams and to determine design criteria that could be used by NDOR or regulatory agencies to identify when structural controls for bridge deck runoff may be necessary to protect in-stream water quality and aquatic life. Throughout the course of the project, in-stream dry weather sampling, sediment sampling, wet weather bridge runoff sampling, and preliminary toxicity testing were conducted. Statistical analysis of in-stream samples upstream and downstream of bridges showed that bridges did not impact the quality of the receiving water body. Sediment sampling did not show an increase in streambed sediment concentrations from downstream to upstream. Two runoff events were also used in a 48-hour 5 dilution series toxicity test with fathead minnows, and no negative effects were found. These results show that there were no observable effects of bridges on water quality and aquatic life.

### 2.3.3 Stormwater Quantity Impacts

Bridge deck runoff quantity can be characterized by runoff volume and peak flow rate, both of which are considerations when evaluating the potential hydrologic effect of bridge deck runoff on receiving streams. Hydromodification should not be an issue from bridge decks alone, since the runoff coefficient is identical to rainfall on the receiving water.

### 2.3.4 Summary

URS (2010) concluded that long-term untreated bridge deck discharges do not have an adverse impact on aquatic toxicity or sediment quality. Additional findings of this review include:

- Quality and pollutant loading in bridge deck runoff is similar to roadway and urban runoff;
- Concentrations of vehicle-derived constituents are highly correlated with average daily traffic;
- Bioassessments made upstream and downstream of bridges found no significant differences;
- Periodic toxicity of bridge deck runoff is possible, but not common (periodic toxicity observed may be linked to roadway deicers);
- Bridge deck runoff did not contribute to stresses from organics or nutrient enrichment; and
- Potential erosion due to concentrated flow from bridge deck drainage systems could impact receiving waters.

If the constituents in bridge runoff are not contributing to impairment for a receiving stream, no stormwater treatment

should be necessary. However, the same concentration profile might require sophisticated BMPs when paired with a high-quality drinking water source. Therefore, efficient and cost-effective stormwater management, including BMP selection, becomes a function of evaluating highway stormwater characterization data with receiving stream surface water quality goals.

In an effort to better mitigate the impacts of stormwater runoff, the National Research Council has recently recommended a shift in stormwater management and regulatory permitting to a more watershed-based approach, where discharge permits are based on watershed boundaries rather than political boundaries (National Research Council 2009). This type of approach would support the conclusion that treatment of bridge deck runoff is most appropriate in cases where a constituent present in highway runoff has been identified to affect a receiving water beneficial use at very low concentrations, and with very short durations (a matter of hours).

*NCHRP Report 474* noted,

Highways typically constitute a very small fraction of a watershed's total drainage area, and bridges often constitute a small portion of the highway drainage area. Thus, highways often, but not always, contribute a small fraction of the overall pollutant load to a given receiving water body, and bridges contribute even less.

According to *NCHRP Report 474*,

This circumstance provides opportunities to consider and implement commonsense solutions such as providing enhanced pollutant removal somewhere else in the right-of-way (ROW), or even somewhere else in the watershed (i.e., off-site mitigation, or pollutant trading).



## CHAPTER 3

# Assessment Procedure

This chapter provides a description of a simplified assessment procedure and a more complex assessment procedure if the DOT is required to assess the impact of the bridge crossing on the receiving water as a part of the 404/401 process. The purpose of using these procedures is to provide the DOT with numeric justification for their selected mitigation program.

It is important to note that the assessment procedures in this chapter will not be useful for all DOTs in all situations. There may be cases in which treatment BMPs are mandated. Examples include requirements of the DOT's stormwater permit; the bridge crosses a water body where the implementation plan of the TMDL requires BMPs; and special situations involving endangered species or high-quality waters. In these cases, there may be no level of assessment sufficient to demonstrate to the regulator that a BMP will not have some level of benefit. If that is the case, the user of this guide should skip forward to Chapters 4 and 5 to identify the most effective and cost efficient combinations of BMPs.

### 3.1 Overview of Assessment Approach

Three fundamental cases are discussed in this section: rural watersheds, urban watersheds, and special situations. The practitioner will be able to classify the project watershed and complete the assessment following the steps provided in this section and as outlined in Chapter 1. The two assessment approaches investigate the likely impact on downstream water quality based on a mass balance approach. These assessments will help explain to regulators the decision of the DOT on the level of mitigation provided for a new, renovated, or existing bridge.

Both the simple and complex assessments consist of performing a mass balance. A detailed discussion of the terms in a mass balance equation is provided in Appendix B. For each of the two assessments described, the mass balance has been simplified by assuming that the analysis is conducted imme-

diately downstream of the bridge such that all constituents are considered conservative and processes steady state.

An underlying premise in this analysis is that the quality of runoff from bridges is not meaningfully different than the runoff from any other impervious area subject to traffic loads (see Section 2.3). Although bridges may discharge directly to receiving waters from deck drains or scuppers on the bridge, the impact is not materially different than if an equivalent amount of impervious cover were constructed adjacent to the receiving water and runoff piped directly to the water body.

#### 3.1.1 Rural Areas

In a rural, largely undeveloped watershed, any impairments or degraded water quality would not be the result of an isolated bridge, but would be associated with either natural conditions or human activities such as Confined Animal Feeding Operations, agriculture, and logging, which would also be the source of the vast majority of stormwater flow in the receiving water. As described previously, a number of studies have been conducted to evaluate the impact of bridge runoff on receiving waters and aquatic ecosystems and none of these has documented increased environmental impairment in the area immediately downstream of a bridge as compared to the upstream condition (URS 2010; Bartelt-Hunt 2012). Consequently, the impact of bridge runoff in primarily rural watersheds is de minimis unless species and site-specific studies identify a unique situation. If the level of mitigation required under a statewide stormwater permit or the 404/401 certification process does not include water quality requirements, further assessment is not warranted.

#### 3.1.2 Urban Areas

The primary factor affecting receiving water health in urbanized areas is the volume and quality of runoff from impervious surfaces in the watershed. The bridge itself is



one of many small impervious parcels contributing runoff and, consequently, it is logical that it be subject to the same regulations as other impervious area. That is, the de minimis assessment approach does not apply because of the cumulative impact of many small impervious parcels. Since DOTs are also subject to stormwater permit requirements in urban areas, the level of mitigation for bridge runoff should be similar to that required for new impervious cover anywhere in the DOT permitted area. If implementation of structural BMPs to treat runoff from new impervious cover is considered necessary to comply with the MEP reduction in the discharge of pollutants as implemented in the applicable NPDES or other regulatory permit, then structural BMPs should be implemented either at the bridge crossing itself or offsite (preferred for performance and cost reasons). Since the level of mitigation required is specified in the stormwater permit, an assessment of water quality impacts is likely unnecessary in this case.

### 3.1.3 Special Situations

There may be special situations in both urban and rural watersheds where implementation of stormwater treatment is requested by regulatory authorities. This can occur as part of the 404/401 process or where the water body has special environmental constraints, such as:

- TMDL watersheds
- ONRW
- Domestic water supply/hazardous spill control
- Presence of endangered species

The primary purpose of the assessment approaches described in this chapter is to address regulatory concerns in these special situations. Before undertaking any of the assessment procedures described in the following sections, it is recommended that the DOT confer with the appropriate regulatory authority to determine which of the assessment procedures the agency will accept for determining the need for bridge deck runoff treatment.

### 3.1.4 Summary

Bridges in urban areas should include a level of stormwater treatment consistent with the local definition of MEP. For many jurisdictions, MEP may be satisfied using the practices described in Chapter 4. If treatment is desired or required, the treatment may take place either onsite or offsite (preferred for cost and performance reasons). The water quality impact of bridges located in rural areas is typically de minimis and no BMPs (beyond those selected as applicable from Chapter 4) are needed. Special situations require coordination with the

appropriate regulatory authority to determine which assessment procedures would be accepted to indicate the need or lack thereof for mitigation. Therefore, only a small number of bridges would need to have an assessment performed.

## 3.2 Simple Assessment Procedure

The simple assessment approach will be used in the case where a regulatory agency is requesting an analysis to assess the change in constituent loading as a result of a bridge crossing. This approach uses dilution calculations to estimate the increase in pollutant load resulting from discharges from the bridge deck to the receiving water. A worked example is provided in Appendix B.

To demonstrate that the water quality impact of any particular bridge is de minimis, a mass balance should be performed. A mass balance consists of determining the percentage of load for any specific constituent of concern contributed by the bridge. EPA has also established policy that a de minimis discharge produces no more than a 10% decrease in water quality for any given water body, and the maximum aggregate decrease in water quality based on multiple de minimis findings is 20% for a water body (King 2006). Taking a more conservative approach, we will consider the contribution de minimis if the bridge contributes less than one percent of the load in the receiving water downstream of the bridge. If the load from the bridge is larger than 1%, then a more complex assessment should be used to determine whether the impact is sufficiently large to justify including either on-site or off-site treatment controls.

$$\text{Load Increase} = \text{Bridge Load} / \left( \text{Bridge Load} + \text{Upstream Load} \right) \times 100$$

where the Load Increase is the percentage of the load downstream of the bridge contributed by the bridge itself, Bridge Load is the load conveyed by the bridge runoff, and Upstream Load is the load in the receiving water upstream of the bridge.

$$\text{Bridge Load} = \text{Rainfall} \times \text{Runoff Coefficient} \\ \times \text{Area of the Bridge Deck} \times \text{Concentration}$$

where the Rainfall is the average annual rainfall for the specific location, the runoff coefficient is assumed to be 1.0 (a conservative value, since actual runoff coefficients tend to be somewhat less), and the Concentration is the average concentration of the constituent of concern (see Table 2-1). If the constituent of concern is bacteria, and there is a need to account for the contribution of birds roosting in the bridge substructure, then a value of  $5.0 \times 10^8$  MPN/d/nest for cliff swallows or  $5.6 \times 10^9$  MPN/d/bird for pigeons can be used in the loading calculation (Sejkora 2011).

$$\text{Upstream Load} = \text{Annual discharge of the receiving water} \\ \times \text{Average Stream Concentration}$$

where the average flow in the receiving water is determined by gauged data at the proposed site or calculated based on a comparison of the upstream catchment area to the flow observed at a gauged location in the vicinity with a known catchment area or computed using one of the many synthetic methods available in public domain programs such as the hydrologic engineering center hydrologic modeling system (HEC-HMS).

For a lake setting, if the bridge crosses a tributary arm of the lake, the most common physical configuration, then the same basic comparison of loads may be made in which the flow in the receiving water is that originating upstream from the bridge crossing. The only difference is the greater upstream surface area of the tributary arm than the stream crossing case, due to backwater from the lake, which affects only the precipitation load term. In some regulatory situations, there may be a concern about accumulation and build-up of pollutants within the main body of the lake, which should be addressed with a more complex assessment.

If the bridge crosses a tributary arm of an estuary, then the relative load in the tributary versus bridge runoff are, again, compared in the same way as the stream crossing, using the drainage area of the tributary arm upstream from the bridge crossing, and the flow estimated from an upstream gauge extrapolated by drainage-area ratio to the bridge crossing, by transfer of record from a nearby gauge, or by application of the rational method using rainfall data. More complex situations may require estimating the additional dilution afforded by tidal exchange.

In a specific situation in the stream, lake, or coastal inlet setting, additional aspects of the receiving water may need to be explicitly addressed. These more complex situations may include the need to consider a mixing zone, or the involvement of kinetics of the pollutants of concern. It may prove adequate to use a somewhat more complicated, but still relatively straightforward order-of-magnitude analysis to quantify the bridge impacts for these situations. Methods are summarized for each watercourse type in the following section.

### 3.3 Complex Assessment Procedure

The complex assessment procedure is suitable to evaluate the concentration of a specific pollutant found in bridge deck runoff in the receiving water once construction or rehabilitation of the bridge is complete. This procedure will be useful for special conditions, such as crossings of ONRW, domestic water reservoirs, or in the case of a TMDL watershed. *NCHRP Report 474* will be referenced for other methods that can further support the complex assessment approach. The complex assessment approach will be described with the option of

using the US Geological Survey (USGS) Stochastic Empirical Dilution Model (SELDM) to complete the assessment.

There may be cases when regulatory agencies require a more rigorous analysis than the simple determination described above of whether the bridge impact in a rural watershed is de minimis. This might occur in situations such as Outstanding National Waters, presences of endangered species, 303(d) listed water bodies where no additional pollutant loading is considered acceptable, or where a TMDL requires pollutant reductions, or other site-specific situations. Consequently, the following sections describe how to calculate pollutant concentrations downstream of the bridge to determine whether water quality standards are likely to be exceeded and treatment BMP implementation should occur. These calculations evaluate a worst-case scenario based on the impact of a design storm occurring during a period of low flow. They require substantially more data and a decision on the design storm size and critical stream discharge (e.g.,  $7Q_{10}$ ) as compared to the simple assessment. A detailed derivation of the equations presented in this section is provided in Appendix B. If the specific regulatory circumstance requires still more detail or sophistication, then the approaches summarized in *NCHRP Report 474* and URS (2010) are suggested.

#### 3.3.1 Stream Environment

The geometric feature that characterizes the stream environment is the large ratio of watercourse length (measured along the principal axis) to width (measured cross-channel, i.e., perpendicular to the longitudinal axis). For a channel of constant cross section  $a$ ,  $R = Q/xa$ ,  $x$  denoting a distance downstream from the bridge and the volume of influence  $V = xa$ . In this case,  $R$  is the reciprocal of the time of travel. For regulatory purposes, the near-field solution is of interest, because most states typically allow a zone of initial dilution (ZID), particularly for those constituents considered toxic. Within the ZID, exceedance of the stream standard is allowed. The ZID may be explicitly specified as, in a stream, a distance downstream from the pollutant source. Even if not explicit, as is often the case with nonpoint sources, demonstration of a concentration within standards for a distance 100 to 1,000 yards downstream will suffice.

Within such a short distance, the concentration downstream of the bridge can be calculated as:

$$c = c_u \left(1 - \frac{1}{D}\right) + c_b \frac{1}{D} \tag{1}$$

where

$c$  = concentration in the water body downstream of the bridge

$c_u$  = concentration in the water body upstream of the bridge

$c_b$  = concentration in the bridge runoff

$D \equiv Q/Q_b$

Equation (1) is a suitable screening test. For storm runoff from even a small single-cell storm,  $D$  is on the order of  $10^4$ .

An analogous equation is offered as Method 1 in *NCHRP Report 474*, in which it is recommended that a “worst-case” condition of a high (95% exceedance suggested) bridge runoff flow be combined with an extreme low (5% exceedance suggested) flow in the receiving stream. This is truly worst case, in that it assumes that rain falls only on the bridge. While a critical low flow may be an appropriate choice for the ambient flow  $Q_a$ , the storm flow does not occur in isolation on the bridge, so the other component flows, given in Equation (5) of Appendix B: Simple and Complex Assessment Methods and Worked Example, must be considered. Even if one only includes the precipitation on the surface of the stream, there is still a factor of  $10^4$  dilution of bridge runoff.

The far-field problem in the river is straightforward and needs only to address the length of stream to its mouth. For most streams, this will translate to a travel time of days to weeks, so the problem devolves to selecting suitable flows to be averaged over this time period. Evaporation rates are rarely high enough to warrant inclusion (except perhaps in the southwest), but it may be necessary to retain the first-order rate  $K$  in Equations (3) or (4) of Appendix B for reactive constituents. A simplified version is suggested as Method 7 for the stream environment in *NCHRP Report 474*.

### 3.3.2 Lake Environment

The most common instance of a bridge crossing of a lake is a traverse of an arm, typically a stream channel now immersed by backwater from the lake. Typically, however, it is the impact on the main body of the lake that is the primary concern. The defining feature of a lake is the large ratio of storage to inflow, i.e., long residence time, so the lake is a cumulative watercourse. It is not the immediate response to runoff events but rather the accumulation of constituents in the lake that potentially affect the beneficial uses of the watercourse. The time scale of analysis is therefore much longer than that of the stream environment. This might be annual flows for large lakes with quasi-permanent temperature structure, but a seasonal analysis, notably the summer, is frequently more appropriate for impact analysis since it targets the season of greatest biological production. Equation (2) is directly applicable, where  $V$  is the volume of the entire lake,  $Q_s$  is the mean seasonal inflow, and  $Q_a$  is incorporated into  $Q_s$  in the averaging process.

$$c(t) = \frac{c_a Q_a + c_s Q_s}{(R + K)V - EA} (1 - e^{-(R+K-EA/V)t}) + c_o e^{-(R+K-EA/V)t} \quad (2)$$

where

$Q_a$  = ambient flow in the watercourse

$c_a$  = ambient concentration in the watercourse

$Q_s$  = storm runoff flow into the watercourse

$c_s$  = storm runoff concentration

$E$  = evaporation rate in depth of water per unit time

$A$  = surface area of the volume of influence

$K$  = first-order decay coefficient in inverse time (i.e., per unit time)

The separation of  $Q_s$  into components is necessary in order to isolate the effect of bridge runoff, but now each component must be estimated based upon seasonal storm occurrences, and each component is determined for the entire volume of the lake, not just the segment upstream from the bridge. For de minimis argument, it may be sufficient to consider only the comparative magnitudes of  $Q_b$  and  $Q_p$ , the latter being easily estimated from seasonal precipitation data.

One consequence of the long integration time of a lake is the increased importance of the first-order kinetic terms  $K$  and  $EA/V$  in Equation (2). Even the concentration of a conservative substance, such as salts or some metals, will be affected over the long term by evaporation. The uptake of reactive constituents like nitrogen species becomes substantial over the summer production season, since metals, over time may become less biologically available as sorption processes occur. A simplified version of Equation (2) is presented as Method 7 in *NCHRP Report 474* for addressing the lake environment (see also Method 2). If the residence time in the lake is less than the analysis period (e.g., a season), then the steady-state version in Equation (3) may suffice for order-of-magnitude estimates.

$$Q_T = \varepsilon H_T A / P_T \quad (3)$$

### 3.3.3 Coastal Inlet Environment

While the coastal inlet watercourse is arguably the most complex of those considered, its complexity in many respects simplifies the estimation problem. Like the lake watercourse, it is the impact on the total volume of the coastal inlet that is of primary concern, so a mass budget over a seasonal or annual time scale is appropriate, and the complex geometry of the inlet is avoided. Unlike the lake, however, the coastal inlet enjoys additional sources of dilution water due to its free connection to the sea and tidal exchanges. Some of these, such as internal circulations driven by density differences between ocean and coastal waters, and storm-driven exchanges can be site-specific and difficult to estimate. The tide, however, is a ubiquitous marine factor whose contribution to exchange can be estimated.

The flow rate entering the inlet on the flood tide (the “tidal prism”) is estimated from the product tidal range  $H_T$  and the surface area of the inlet  $A$ :

$$Q_T = \varepsilon H_T A / P_T \quad (4)$$

Range is the difference between the heights of high tide and low tide, and statistics on range are readily available for

each of the NOAA tide gauges that dot the coastline of the United States.  $P_T$  is the period of the tide (or, more precisely, the dominant period), and for present purposes  $P_T$  takes on one of two values, 12.4 hours for semidiurnal tides, characteristic of most of the Atlantic and Pacific coasts, and 24.8 hours for most of the gulf coast. The coefficient  $\varepsilon$  is a measure of the proportion of “new” water brought into the inlet on each tidal cycle, in contrast to inlet water carried out to sea but then returned to the inlet on the next tide.

Equation (3) is applied to the inlet, for which  $Q_a$  is neglected, and

$$Q_s = Q_p + Q_T + Q_b \quad (5)$$

where

$Q_s$  = mean seasonal inflow

$Q_p$  = flow from precipitation on the water surface

$Q_T$  = volume entering the inlet on flood tide

$Q_b$  = runoff from the bridge

Like the lake, the volume of influence  $V$  is the entire volume of the inlet and the period of analysis is long-term, either seasonal or annual. The precipitation component  $Q_p$  is that for the surface area of the inlet, and  $Q_T$  is computed from Equation (4). Residence time in a coastal inlet is typically relatively short, so the steady-state solution Equation (3) may suffice for estimation purposes.

As noted above, the estuary represents an extremely important special case of the coastal inlet, whose defining characteristic is a source of freshwater inflow, which is some combination

of riverine inflow and runoff from the surrounding drainage area. For estimation purposes, the same procedure as for the lake may be applied, except now the tidal prism flow  $Q_T$  is added to the separation of flow components, though for a de minimis argument, it may be sufficient to consider only  $Q_p$ .

A common bridge crossing configuration in an estuary is a riverine or tributary arm of the estuary. In this case, the concern may be impacts on that reach of the estuary immediately downstream from the bridge. This problem is addressed exactly like the stream environment applying Equation (2) or (3) in which  $Q_a$  may be retained as an ambient inflow, perhaps a critical low flow. Depending upon local circumstances, a long time scale may be used in which inflows and rainfall are averaged over an extended period of time, or, if the near-field problem is a concern, specific characteristic storms may be used to estimate the relative contribution of the component flows. Flow from the upstream drainage area  $Q_d$  might be included in this estimation, but, as above, it may be sufficient for the de minimis argument to consider only the precipitation on the water surface  $Q_p$ . In marginal cases, it may be desirable to include the tidal prism component explicitly, but generally this can be omitted with the observation that an estuary has additional sources of dilution besides inflows. So their neglect is, in effect, a worst-case approximation. In more complex modeling problems, such as for waste-load allocations, these are represented by a large dispersion term in the mass budget.

Appendix B provides a worked example using the complex assessment approach.



## CHAPTER 4

# Stormwater and Other Source Control Practices to Consider for All Bridges

The objective of this chapter is to present BMPs that should be considered for all bridges, as appropriate, depending on the setting and the type of bridge construction. These source control, operation, and maintenance practices will avoid or reduce loading of pollutants to the receiving water. The practitioner must determine which measures discussed herein apply to each bridge crossing. A number of factors must be considered when selecting source control and operation and maintenance BMPs, including the estimated cost of the measure as compared to the estimated benefit. The practitioner must consider the receiving water conditions, pollutants of concern, and sources of those pollutants, and balance these assessments against the effectiveness of the measure, potential operational hazards and liabilities, and long-term cost as compared to other practices that may be as effective but have a lower whole life cost.

## 4.1 Collection and Conveyance of Deck Runoff

Collection and conveyance of runoff along the bridge is important not only from the perspective of maintaining dry lane criteria, but also from the perspective of managing scour at the discharge point. In some instances, runoff is collected and conveyed in pipe systems and directed towards the abutments. Such pipe systems can result in issues associated with leaking, additional capital cost, and are generally more difficult to maintain. However, in most instances runoff from a bridge is collected in a comparatively simpler deck drain or scupper system. For the purposes of this guide, a deck drain is considered any drain with a grate opening that is installed flush into the deck of a bridge. A scupper is considered a circular or rectangular slot opening within the bridge railing wall. Care must be taken in assessing slopes and approach areas to bridges, to ensure that runoff is conveyed to the receiving water without the potential to create scour and introduce TSS and turbidity into runoff.

### 4.1.1 Scour Protection at Collection System Discharge Points

A direct discharge of bridge runoff from a deck drain or scupper to the bank areas should not be used without sufficient scour protection at the point of impact of the flow. Free fall drainage from the bridge superstructure can have substantial kinetic energy that can loosen soil particles and cause erosion, particularly entraining colloidal particles that contribute to turbidity in runoff. The point of impact from free fall drainage can also be difficult to predict since it is subject to the influence of wind and dispersion. For this reason, riprap pads placed at the anticipated point of impact can be of limited effectiveness in controlling erosion from free fall drainage if they are not properly sized. A minimum size of 3ft. by 3ft. is recommended, with the caveat that the pad be inspected after storm events and enlarged if impact scour is observed adjacent to the pad.

Runoff collected from a deck drain or scupper located in stream bank areas can also be conveyed in a pipe either along the rail or under the deck, and then down the abutment, column or the piers (down drain). A 90 degree elbow (or similar) should be used to direct discharge horizontally into a suitably stabilized area (such as with riprap) to create a condition of sheet flow at the discharge point. The use and experience with piping of deck runoff varies by DOT and maintenance personnel should be consulted to ensure the selected system can be maintained.

Scour at the outlet of a bridge down drain is a function of the discharge rate, duration of flow, the outlet shape and size, and soil type (Thompson and Kilgore 2006). A drop between the outlet and ground surface should be avoided, but if necessary, considered in the determination of scour. The practitioner is encouraged to review FHWA Publication No. FHWA-NHI-06-086 (HEC 14) for specific methods to predict scour-hole geometry. Predictive methods should be used in combination with estimates of erosion at similar

locations. Since most bridge down drains are relatively small in diameter, a riprap apron consisting of suitably sized rock on top of a filter blanket would be an effective approach when placed at the outlet, and computing scour hole dimensions as detailed in HEC 14 would not be necessary. Flow expansion should be computed using a 4:1 ratio to determine the length of the pad. The depth of flow at the edge of the pad should result in a velocity that will not scour native material. Over their service life, riprap aprons may experience a wide variety of flow and tail water conditions. For this reason, maintenance personnel should inspect them after major flood events. If repeated damage occurs, extending the apron or replacing it with another more robust type of energy dissipater (such as a riprap stilling basin) should be considered.

Equally important is to assess runoff flow paths around the bridge structure. Abutment walls may create preferential flow paths where they meet the fill slope, with the potential for rills or gullies during runoff events. Care should be taken to ensure that local drainage from the deck, approach roadway, and abutment fill slopes does not cause scour, which can result in increased turbidity in the receiving water. Riprap and concrete ditches can be used to convey runoff where velocities would scour native soils. The need for engineered energy dissipation should always be assessed at discharge points. Concentrated runoff should not be allowed to flow uncontrolled over slopes; grading should include benches and/or terrace drains when slope lengths exceed local requirements.

## 4.2 Bird Roosting

### 4.2.1 Background

The configuration of the substructure of the bridge may provide habitat for wildlife that can act as a continuing source of indicator bacteria. Wildlife that inhabits the underside of bridges includes cliff swallows, pigeons, and bats. Geese have been observed to rest on bridge piers in Portland, Oregon. This section will provide design recommendations to discourage bird roosting and nesting by cliff swallows.

Cliff swallows build mud nests under bridges at any location where a vertical surface meets a horizontal overhang at a right angle. While such habitat was typically naturally limited to cliff formations, the birds' range has expanded substantially due to the adequate nesting sites provided by bridges, culverts, and buildings (Figure 4-1). When building their mud nests, the swallows prefer a rougher surface texture, and consequently are more prone to roost on concrete structures than on wood and steel. A highly social bird, the swallows form nesting colonies that contain as many as 3,500 individuals.

A study in the Austin, Texas, area demonstrated that nesting colonies of cliff swallows on bridges are a significant source of *Escherichia coli* and fecal coliform for the underlying surface



**Figure 4-1. Distribution of cliff swallows in North America (Brown and Brown 1995).**

water during the nesting period (Sejkora 2011). The concentrations of these two indicator organisms downstream of the bridge were significantly higher than the concentrations upstream of the bridge during dry weather. The elevated *E. coli* concentrations downstream of the bridge nesting site were fairly constant through the day and night and persisted at least three quarters of a mile downstream. In this case, the most likely cause of this pollution is the direct deposition of swallow feces from nests over the water body. The data and visual observation of the swallows' behavior indicate that the peak loading of *E. coli* and fecal coliform corresponded with the approximately 20-day period between the hatching and fledging of the nestlings.

Of course, the extent of the impact will depend on the size of the water body and the number of cliff swallows. Sejkora (2011) reported that the average *E. coli* loading per over-water nest for the nesting periods was about  $5.0 \times 10^8$  MPN/d/nest. This value can be used in conjunction with the number of nests and the flow rate of the water body to calculate the expected impact and determine whether BMPs should be implemented.

The feral rock pigeon is a nonnative, non-migratory bird that can be found on ledges under bridges throughout the United States. As a social bird, pigeons often form flocks for feeding, roosting, and breeding purposes. More often, pigeons can be found in greater numbers in more urban settings due to the greater availability of food sources and shelter

(Sacchi et al. 2002). Sacchi et al. (2002) cited several densities of pigeons in urban environments. For example, the densities of pigeons per square kilometer for urban and rural London were 200 to 400 vs. 12 to 14, respectively.

Many of the concerns regarding urban pigeon populations stem from aesthetic and health concerns posed by droppings. A single pigeon produces 12 kilograms of excrement per year (Haag-Wackernagel and Geigenfeind 2008). Whereas some birds temporarily vacate their nesting and roosting sites to defecate, pigeons do not discriminate where their feces are deposited (Johnston 1992). Parents do not remove the squabs' fecal matter from the nest, causing extensive buildup of hardened material.

Pigeon feces are a known vector of some waterborne pathogens; their excrement has been shown to harbor waterborne pathogens such as *Clostridium perfringens*, *Salmonella enteric*, and *E. coli* (VTEC) (Haag-Wackernagel and Moch 2004). Given this risk, several studies have investigated bacteria species present in pigeon droppings. Oshiro and Fujioka (1995) found each gram of pigeon excrement contains approximately  $1.7 \times 10^8$  *E. coli*. As with cliff swallows, this value can be used along with the receiving water characteristics to determine whether BMPs to exclude pigeons from the underside of bridges would be effective in protecting water quality.

#### 4.2.2 BMPs to Discourage Roosting under Bridges

The control of migratory birds, such as cliff swallows, is stipulated by the U.S. Dept. of Fish and Wildlife Service (2003). Migratory birds are protected under the Migratory Bird Act of 1918. As such, it is unlawful to harm, kill, or remove swallows or their eggs and nests. In general, permits for the removal of swallow nests under bridges must be obtained during the nesting season. A permit may only be obtained for compelling reasons such as safety concerns pertaining to airports or food manufacturing facilities. If such a permit is obtained from the Department of Fish and Wildlife, the nests may be knocked down in the manner specified in the permit (USFW 2003). Most often, the nests are washed off with a hose or knocked down with a pole. Subsequent to the nests being removed, it is imperative that humane exclusion methods are employed; otherwise, swallows might return and recolonize the site. During non-nesting seasons, nests may be removed if it can be ascertained that they are uninhabited. Again, exclusion methods should then be employed to discourage re-colonization.

Pigeons and other birds that are non-native to the United States are subject to far greater control measures, such as trapping and poisoning. However, such methods are not encouraged as they are usually ineffective and are regarded as inhumane.

One of the most common exclusion techniques to dissuade bird colonization of structures is bird nets. Bird nets can be successfully implemented by either pulling the net taut across roosting areas or simply allowing the net to hang loosely several centimeters from the roosting and nesting area (Gorenzel and Salmon 1982). Palmer (1982) found bird nets to be 95% effective at deterring pigeons. Literature also suggests that bird netting can be used to seal off crevices underneath bridges that might be prone to bat habitation (Kern 1995). However, bird nets can have maintenance issues; if they become torn, they must be mended or replaced (Gorenzel and Salmon 1982). Additionally, debris could potentially get caught within the netting, which makes netting subject to frequent cleaning. The expected life for bird netting cited by Gorenzel and Salmon (1982) is 3 to 5 years.

Another common BMP to discourage the roosting birds are wire spikes installed on ledges underneath the bridge. These metal or plastic spikes can be laid in strips on roosting sites, making the area unappealing to birds. While these spikes are generally effective at excluding birds, care must be taken at selecting the size and spacing of the spikes in order to make them most appropriate for the bird species in question. Spikes also must be properly maintained, as debris buildup on the spikes can reduce their efficiency (Bishop 2003).

When new bridges are being built, architectural considerations can also be implemented to deter swallows and other birds from nesting beneath the bridge. Gorenzel and Salmon (1982) note that swallows prefer nesting sites where overhanging eaves meet the wall of a structure at acute or right angles. Concave or obtuse angle interfaces are rarely used as nest sites. Right angle interfaces on existing structures can be retrofitted with plastic, fiberglass, or metal fittings to make the interface less appealing to swallows. Bird spikes and nets strategically placed at right angle interfaces also might be successful at deterring swallows from nesting. Salmon and Gorenzel (2005) illustrated the four main methods for exclusion of birds (Figure 4-2).

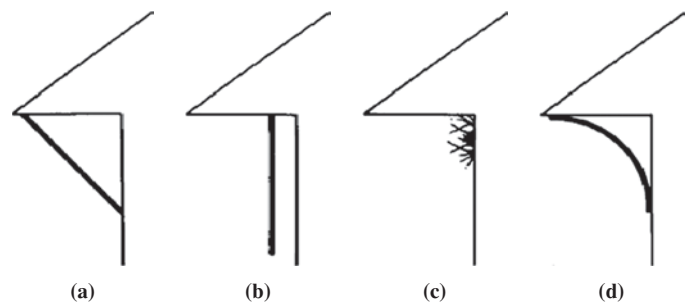

**Figure 4-2. Four methods that may deter bird nesting (a) netting attached from the outer edge of the overhang down to the side of the bridge; (b) a curtain of netting; (c) metal projections along the junction of the wall; (d) fiberglass panel mounted.**

Bats are often found roosting under bridges and their presence may need to be controlled. In some locations, bats may only be managed by licensed pest control services. However, great care must be taken in mitigating bats due to their important ecological role. It is estimated that the bats from the Congress Avenue Bridge in Austin, Texas, consume upwards of 10 to 15 tons of insects per night (Keeley and Tuttle 1999).

Bats are noted to most often use parallel box beams with small crevices between them as a dwelling site. Expansion joints and other crevices also should be designed with care; it is cited that bats prefer crevices with a width of 0.75 to 1 inch (Keeley and Tuttle 1999). The humane exclusion of bats is described thoroughly by Bat Conservation International (Keeley and Tuttle 1999). All crevices present in the bridge superstructure greater than 0.25 inches must be sealed to prevent bats from entering or reentering. This can be accomplished with wood, backer rod, expanding foam, or caulk. The primary exit points used by the bats are then fitted with one-way valves such as PVC pipes, which allow any bats remaining in the structure to exit without allowing any more to enter.

An alternative to deter bats and birds from inhabiting bridges overlying water bodies is to provide them with a preferential roosting site nearby (Keeley and Tuttle 1999). In this case, the nuisance animals might vacate the site of concern and inhabit the preferential site at a less environmentally sensitive location.

### 4.3 Bridge Construction Materials

Previous research by NCHRP has shown that portland cement concrete (PCC) and asphaltic concrete (AC) and constituents used in their production represent the largest volume of construction and repair material for highways. Additionally, it is known that many agencies are routinely using industrial by-products in construction materials. AC is the most widely used road surfacing material in the world, constituting more than 90% of the surfaced roads in the United States. Asphalt products are also used in surface treatments and base courses of roads and as repair materials. The wide application of asphalt has also spawned a large number of additives. A list of common additives includes liquid and fibrous polymers; rejuvenating agents (light-molecular weight petroleum products); carbonblack; sulfur; and crumb rubber (ground scrap-tires). PCC is also associated with transportation infrastructure construction. In addition to its use in pavements, PCC is a particularly relevant material in the discussion of bridge construction and stream stabilization.

As with AC, the wide range of uses has led to a proliferation of admixtures for PCC. These admixtures are used to improve the concrete properties with respect to workability, durability, and strength. A list of common additives includes air entraining agents (e.g., organic salts, organic acids, fatty

acids, detergents); water reducers (e.g., lignosulfates, lignosulfonic acids, sulfonated melamine, sulfonated naphthalene, zinc salts); strength accelerating agents (e.g., calcium chloride, calcium acetate, carbonates, aluminates, nitrates, calcium butyrate, oxalic acids, lactic acids, formaldehyde); and other, less common admixtures (e.g., coloring agents [iron oxides and titanium dioxide]; corrosion inhibitors [sodium benzoate]; fillers [fly ash, bottom ash, furnace slags]; and pumping aids [acrylic polymers, polyethylene oxides, polyvinyl alcohol]) (Nelson et al. 2001).

Although AC and PCC constitute the majority of the construction and repair materials commonly used, other materials are also routinely included in bridge and other transportation projects. These materials include treated timber, reinforcing steel, reinforcement fibers, epoxy-based materials, cathodic protective coatings, pipes, and bridge deck sealers. Use of such materials brings additional chemicals (e.g., creosote, ammoniacal-copper-zinc-arsenate or ACZA, and copper-chromated-zinc, or CCA) (Nelson et al., 2001).

The impact of the most common construction and repair materials and their mobile constituents on surface and ground waters were studied within *NCHRP Report 448*. This report found that in their “pure” form, that is, prior to incorporation into an “assemblage” such as AC mix or PCC, many highway construction and repair materials exhibit high toxicity. However, in most of the construction and repair materials, toxicity is considerably reduced after incorporation into the final assemblage (e.g., pavement or fill). Further investigation of leaching rates also showed that toxicities to aquatic organisms are generally much lower under field conditions because of reduced mass transfer and soil sorption (Nelson et al. 2001).

One material not specifically addressed in *NCHRP Report 448* that has been historically significant in bridge construction is galvanized steel. Bridge components have been hot-dip galvanized for many years. This process places the entire steel component into a vessel of molten zinc. The zinc coats the steel with the heat of the process causing the formation of several metallurgical transition layers between the steel and zinc. This process results in a corrosion-resistant, adherent coating on the steel (Kogler 2012). Galvanized steel components exposed to rainfall can result in high concentrations of dissolved zinc in runoff. Barrett (2010) reports that samples of rainfall dripping from galvanized bridge rail were collected at a site in Texas, and concentrations of zinc in the sample ranged from 3,260  $\mu\text{g/l}$  to 9,480  $\mu\text{g/l}$ . For this reason, DOTs should consider painting bridge components that are hot-dip galvanized with a non-lead based paint to reduce the potential for zinc transport to receiving waters.

One potential alternative to the use of galvanized steel for corrosion protection is the use of weathering steel. The primary benefit of weathering steel is the promise of long-term



corrosion protection without the need for either initial or maintenance painting (Kogler 2012). Bridge painting is discussed further in Section 4.4.1, and can be significant as a potential source of lead and other pollutants in receiving waters during maintenance. This is because lead-containing alkyd paint was used to protect steel bridges for several decades. However, the receiving water risk associated with weathered steel as a potential source of iron and other metals that make up the alloy is unknown. The practitioner should weigh the risk associated with potential metal transport against the benefits of eliminating paint maintenance over the long term to determine the viability of weathered steel as an alternative bridge construction material.

## 4.4 Bridge Maintenance

### 4.4.1 Painting Materials and Methods

#### 4.4.1.1 Pre-Maintenance Assessment of Bridge Paint

As noted in *NCHRP Report 474*, bridge repainting is probably the most common bridge maintenance practice and the one with potentially the greatest adverse effect on the receiving water. Blasting abrasives and paint chips from preparation activities may fall into the receiving waters below the bridge during surface preparation. Surveys (CTC 2009) have indicated that up to 80% of existing bridges that require repainting have paint containing lead. In addition, lead bridge paint can also contain other constituents including asbestos, arsenic, chromium, and cadmium. The surveys also indicated that substantial amounts of used abrasives could be lost to the environment if appropriate containment practices are not followed. Prior to initiation of a maintenance plan involving bridge painting, an assessment should be performed to identify the presence of lead, asbestos, arsenic, chromium, and cadmium, as the presence of any or all of these constituents will directly impact the ability to recycle residual paint, or transport and dispose of it. Contractor noncompliance with contract specifications for handling and disposal of solid waste/hazardous waste are among the greatest challenges to the successful completion of bridge repainting. The assessment of paint materials should follow the EPA “Toxicity Characteristic Leaching Procedure” (TCLP) and EPA SWA-846. For more information, the practitioner should refer to <http://www.epa.gov/osw/hazard/testmethods/sw846/index.htm> and [http://www.epa.gov/osw/hazard/testmethods/faq/faq\\_tclp.htm](http://www.epa.gov/osw/hazard/testmethods/faq/faq_tclp.htm)

#### 4.4.1.2 Paint Selection, Storage and Handling

The following information was consolidated from the AASHTO Center for Environmental Excellence web site ([environment.transportation.org](http://environment.transportation.org)). Proper paint selection, storage,

and handling will reduce potential impacts to receiving water quality. Paint with a long service life should be used to reduce the frequency of removal and reapplication. Before starting work, verify that the paint has not exceeded its shelf life or pot life. Pot life refers to the length of time paint is useful after its original package has been opened or, for two-component systems, the length of time after it has been mixed. Pot life is temperature dependent. The pot life on the product data sheet is generally for 21°C (70°F). Contact the manufacturer for additional pot life information if the paint has been stored in temperatures outside of this general range. Exceeding the pot life can result in sagging of the fresh paint along with poor performance attributable to film porosity and/or poor paint adhesion. Two-component paints tend to become unworkable at or beyond their pot life.

Paint should be kept in a secure location to avoid vandalism and accidental spills. It should also be stored in an area that will not be subject to temperatures beyond the recommended limits. Going beyond the acceptable temperature range can cause changes in viscosity and shelf life. Water-based paint will spoil when stored below freezing. Solvent-based paint, on the other hand, may gel or become flammable or explosive when stored at high temperatures. When transporting paint to and from the job site, use containers with secure lids, and ensure that containers are tied down to the transport vehicle. Do not transfer or load paint near storm drain inlets or watercourses.

When mixing paint or using thinner, the instructions on the product data sheet should be strictly followed. Paints have different mixing requirements. The product data sheet will indicate the specific type and maximum amount of thinner to be used. Check drying and curing times on the product data sheet to determine when the next coat of paint can be applied. Recoating before enough time has passed can seriously affect the curing and integrity of the layer being over coated. Some paints, particularly two-component paints, have a maximum time to re-coat as well. Exceeding this could jeopardize the adherence of the top coat. Recycle paint when possible and dispose of unused paint at an appropriate hazardous waste facility. All clean-up water should be captured and disposed of properly.

Collect runoff from sand blasting and high-pressure washing. Filter runoff through an appropriate filtering device (e.g., filter fabric) to keep sand, particles, and debris out of storm drains if the wash water (without cleaning agents) will be discharged to land. If wash water containing a cleaning compound (such as high-pressure washing with a cleaning compound) is generated, plug nearby storm drains and vacuum/pump wash water to the sanitary sewer.

#### 4.4.1.3 BMPs During Painting

A variety of BMPs can be implemented during painting to limit pollutant discharge. When possible, schedule painting

activities for dry weather, and test and inspect spray equipment prior to starting to paint. Tighten all hoses and connections and do not overfill the paint container. Plug nearby storm drains (using sandbags or fabric and stone) prior to starting painting or sandblasting where there is significant risk of a spill reaching storm drains.

Perform work on a maintenance platform, or use suspended netting or tarps to capture paint, rust, paint-removing agents, or other materials, to prevent discharge of materials to surface waters if the bridge crosses a watercourse. A floating silt mat can be used to protect receiving water systems from debris generated during routine paint blasting and other maintenance operations. A silt mat is similar to a turbidity curtain but its primary purpose is to collect debris and waste that might otherwise fall directly in the water. Floating silt mats have been shown to perform effectively in high current areas where conventional turbidity curtains might fail. Accumulated material and debris collected within the floating silt mat will usually require handling, transport, and disposal as solid waste or hazardous waste.

Sand blasting can be performed as an “open” or “closed” operation. An open operation requires full containment. A project-specific containment plan should be developed including drawings, equipment specifications, and calculations (wind load, air flow, and ventilation when negative pressure is specified) prior to the start of work. The plan should also include copies of the manufacturer’s specifications for the containment materials and equipment that will be used to accomplish containment and ventilation. Closed abrasive blasting or vacuum blasting allows dust, abrasive, and paint debris to be vacuumed simultaneously with the blasting operation. Debris is separated for disposal and the abrasive is returned for reuse. Closed vacuum blasting equipment is expensive; however, both worker exposure to dust and environmental emissions can be minimized if operations are conducted properly. Closed blasting is limited by its reduced production rate and operational problems cleaning edges and irregular surfaces. To be completely effective, the whole nozzle assembly must be sealed against a surface to maintain proper suction for the vacuum operation.

Clean up afterwards by sweeping or vacuuming thoroughly, and/or by using absorbent and properly disposing of the absorbent. Disposal of lead-based paint must follow the applicable procedures specified within the Resource Conservation and Recovery Act (RCRA). As a contingency measure, the contractor should keep clean-up materials readily available and in a known location so that spills can be cleaned up immediately.

#### 4.4.2 Bridge Washing

Washing of bridges is known to produce the potential for migration of pollutants associated within winter maintenance,

such as excess deicing agents, sand, and chlorides. In the case of steel bridges, wash effluent can produce a solution containing high levels of copper, zinc, and lead.

A range of best management practices should be followed to limit the potential for transport of these and other pollutants. These best management practices should be used prior to, and during washing.

Prior to washing the bridge surface, sweep sand, debris, and sediment from the bridge. Sand can be transported to a maintenance yard for storage and subsequent recycling. Material accumulated on the bridge deck should never be swept into open deck drains or over the edge of the bridge. All scuppers and other drains should be blocked with unbroken sand bags or as discussed in Section 4.4.5 to prevent accidental discharge of wash water to the surface waters under the bridge. Sweeping, instead of washing, may be preferred near sensitive water areas or where there is direct discharge to waters of the United States; however, washing of the bridge bearings, joints, and sub-structure may be necessary for structure maintenance.

When washing the bridge surface and superstructure, aim water hose nozzles to minimize overspray into surface waters or the roads below the bridge. Whenever possible, water should be aimed in a manner to force any remaining sediment or debris towards a flat vegetated area. Water washed over a vegetated area must not cause scour or contribute to sedimentation of the waterway. Limit water pressure when washing steel bridge components so as to avoid the accidental dislodging of paint, which might end up in the water body beneath the bridge. If paint is observed being displaced, cease washing operations. Pressure washing shall also be limited to prevent undercut of grout or harm to the masonry plates beneath the bearings. To the extent practicable, washing of bridges should be scheduled on structures during a time that coincides with high-flow periods or periods following storm events. If displacement of bats or nesting birds is observed, cease washing operations. Promptly report and document any accidental discharges to water bodies and the corrective measures taken to cease the discharge and prevent additional discharges.

Safety is a large concern during washing operations and must be planned at off-peak times and appropriate traffic control must be provided.

#### 4.4.3 Winter Maintenance

Winter maintenance activities such as salt and sand and other product applications are a potential threat to receiving water quality. These activities substantially increase the sediment and/or chloride (salt) load in bridge runoff. Chloride is extremely mobile and soluble, and once it has been introduced to the environment it is practically impossible to remove without advanced treatment. The only practical option is to minimize the use of salt. Sand on bridges can

be removed through an aggressive street sweeping program. Street sweeping issues will be discussed in Section 4.4.4.

A balanced approach should be used during application of salt for snow and ice control (The Salt Institute 2007). This will result in providing the necessary level of safety for traffic, while minimizing the potential for transport of pollutant constituents that results from over application. Determining a properly calibrated application rate in conjunction with the use of automated spreader control systems can keep the amount of salt needed for adequate traffic protection to a minimum. Proper application rates will consider variations in road surface temperature, type of precipitation, and the tendency for accumulation. The practitioner should keep in mind that there is no direct correlation between yearly snowfall and the total quantity of salt required for effective traffic protection. The type of storm dictates the frequency of application and total amount of salt necessary. For example, a short-term freezing rain or ice storm may require large amounts of salt, perhaps even more than a prolonged snowstorm. Table 4-1 illustrates the relationship between road temperature, meteorological condition, ideal salt application rate, and resulting coverage per two-lane mile of bridge.

It is important to note that most typically available temperature information from traditional meteorological sources is measured at 30 feet above the ground (The Salt Institute

2007). Determining the optimal salt application rate for a bridge should be based upon the actual deck or roadway temperature, as opposed to air temperature. Gaining this type of information requires road sensing systems or having access to a Road Weather Information System (RWIS) (The Salt Institute, 2007).

Calibration of spreaders is critical in ensuring that the planned application rate achieves the actual application rate. Calibration involves calculating the pounds per mile actually discharged at various spreader control settings and truck speeds. It is carried out by first counting the number of auger or conveyor shaft revolutions per minute, measuring the salt discharged in one revolution, then multiplying the two and finally multiplying the discharge rate by the minutes it takes to travel one mile. An example of a calibration chart in spreadsheet format can be found on the Salt Institute website at: <http://www.saltinstitute.org/images/calibrationchart.xls>.

**4.4.3.1 Salt Application Techniques for Pollutant Minimization**

Several techniques should be observed when applying salt on or near a bridge deck. These techniques include pre-wetting, determining the proper spread width, consideration of wind effects, consideration of plow timing relative

**Table 4-1. Salt application guidelines for bridges.**

Condition	Suggested Application Rate	Coverage Per Cubic Yard Salt Per Two Lane Mile
Temperature near 30°F Precipitation snow, sleet, or freezing rain Bridge surface wet	If snow or sleet, apply salt at 500 lbs. per two-lane mile. If snow or sleet continues and accumulates, plow and salt simultaneously. If freezing rain, apply salt at 200 lbs. per two-lane mile. If rain continues to freeze, re-apply salt at 200 lbs. per two-lane mile. Consider anti-icing procedures.	Snow/Sleet – 4 Freezing Rain – 10
Temperature Below 30°F or falling Precipitation snow, sleet or freezing rain Bridge surface wet or sticky	Apply salt at 300-800 lbs. per two-lane mile, depending on accumulation rate. As snowfall continues and accumulates, plow and repeat salt application. If freezing rain, apply salt at 200-400 lbs. per two-lane mile. Consider anti-icing and deicing procedures as warranted.	Snow – 6 to 2 ½ Freezing Rain – 10 to 5
Temperature below 20°F and falling Precipitation dry snow Bridge surface dry	Plow as soon as possible. Do not apply salt. Continue to plow and patrol to check for wet, packed or icy spots; treat only those areas with salt applications.	N/A
Temperature below 20°F Precipitation snow, sleet, or freezing rain Bridge surface wet	Apply salt at 600-800 lbs. per two-lane mile, as required. If snow or sleet continues and accumulates, plow and salt simultaneously. If temperature starts to rise, apply salt at 500-600 lbs. per two-lane mile, wait for salt to react before plowing. Continue until safe pavement is obtained.	Snow or Sleet – 4 to 2 ½
Temperature below 10°F Precipitation snow or freezing rain Bridge surface accumulation of packed snow or ice	Apply salt at rate of 800 lbs. per two-lane mile or salt-treated abrasives at rate of 1,500 to 2,000 lbs. per two-lane mile. When snow or ice becomes mealy or slushy, plow. Repeat application and plowing as necessary.	Snow or Freezing Rain – 2 ½

Source: The Salt Institute, 2007

to salt application, and how plowing influences the need for re-application.

Pre-wetting salt with brine speeds the reaction time of salt and keeps salt from bouncing off the road so more of it is available to melt the ice and snow. This effect also helps minimize salt transport potential. However, brine use should include careful consideration of how varying concentration and temperature influence the effectiveness in deicing and snowmelt. Brine will only be effective on bridge decks with a temperature between  $-6^{\circ}\text{F}$  and  $30^{\circ}\text{F}$ , and in concentrations of 5 to 23% salt, by weight (The Salt Institute 2007). Various material alternatives to brine exist for use in pre-wetting. A tool has been developed by the National Academy of Sciences to evaluate relative tradeoffs between cost, performance, and environmental impact of brine application that can be used by DOT practitioners. Refer to the following web site for a copy of the tool and additional information regarding the selection of environmentally sensitive pre-wetting materials: [www.saltinstitute.org/snowfighting/index.html](http://www.saltinstitute.org/snowfighting/index.html).

Salt spreading on bridges is typically done by applying a windrow of salt in a 4–8 foot strip along the centerline. This technique is effective on two-lane pavements with a low to medium traffic count (The Salt Institute 2007). Less salt is required with this pattern and quickly gives vehicles clear pavement under the wheel areas. Traffic will soon move some salt off the centerline and the salt brine will move toward both shoulders for added melting across the entire road width. It is important in this scenario to remove remaining snow from the shoulder area as quick as possible, since when snowmelt occurs, it will potentially re-freeze and necessitate re-application. As snow melts within the shoulder area, avoid or minimize the use of salting directly onto deck drains and scupper areas.

Consciousness of wind conditions is also an important aspect when spreading salt. A strong wind blowing across a bridge can cause salt to drift as it comes out of the spreader, pushing it onto the shoulder area where deck drains are located. This is particularly true in rural areas where there are few windbreaks. How the wind affects spreading depends on both velocity and pavement condition. The operator or application crew should avoid areas where high wind has the potential to blow salt over the side rails or into the deck drains or scuppers.

It is important also to know when to plow and re-apply salt. Salt use can be minimized by giving it appropriate time to work. Plowing operations should be timed to allow maximum melting by salt. The need for another salt application can be determined by watching melting snow kicked out behind the vehicle tires. If the slush is soft and fans out like water, the salt is still effective. Salt should only be re-applied once the slush begins to stiffen and is thrown directly to the rear of vehicle tires (The Salt Institute 2007).

#### 4.4.4 Sweeping

Street sweeping is a practice that DOTs use to remove accumulated trash, debris and sediment along roadways. The technology of street sweeping continues to improve, and sweepers have become much more effective at removing finer sediment. There have been a variety of studies to evaluate whether removal of sediment and associated pollutants would improve stormwater runoff quality. Sweeping is an effective BMP for use on bridge decks, and is a practical alternative to washing the roadway.

WSDOT (Nguyen 2013) is using sweeping as a primary BMP for the SR 520 Floating Bridge Project, set to finish construction by 2016. The SR 520 floating bridge is an example of a design with very little longitudinal grade, restricting the use of a bridge deck conveyance system. WSDOT successfully negotiated a defined sweeping program as a BMP for the bridge partially in lieu of other deck runoff treatment options.

The main factors effecting the removal of solids from the street for sweeping are:

- The type of equipment used and speed
- The frequency of sweeping
- Other important variables include the time of day, and the time to the next rain event.

Pollutants that can be reduced through sweeping are:

- Sediment
- Organic debris
- Trash/litter

Secondary pollutants associated with sediment and likely to also be reduced include:

- Bacteria
- Heavy Metals
- Phosphorus

There are three principal types of street sweepers currently available: mechanical, vacuum, and high-efficiency regenerative air. Mechanical sweepers are equipped with water tanks and sprayers used to loosen particles and reduce dust. Mechanical brooms gather debris under the sweeper and the vacuum system pumps debris into the hopper. The majority of debris, especially the heavy debris, is collected within 36 inches of the curb line: mechanical sweepers are designed to do an effective job of cleaning within this area. Even though this type of sweeper typically uses water-based dust suppression systems, they exhaust a high level of particulates into the atmosphere on a continual basis.

Vacuum-assisted street sweepers use a high-powered vacuum to suction debris directly from the road surface and



transfer the debris into the hopper. Research has shown that these machines are significantly more effective at removing sediment, nutrients, and metals than standard mechanical sweepers (Weston Solutions 2010).

Regenerative air systems are more environmentally friendly than mechanical sweepers (Southerland 2011). Regenerative air sweepers employ a closed-loop “cyclonic effect” to clean the air before reusing it again to clean the street surface. They are similar to vacuum sweepers in that there is a vacuum inlet located on one side of the sweeping head. Unlike vacuum machines, however, regenerative air sweepers constantly recirculate (regenerate) their air supply internally. Regenerative air technology has become widely seen as having a number of advantages: cleaning a wider path, removing small particles more effectively, and limiting the amount of dust-laden air that is exhausted back into the atmosphere. Since these machines “air-blast” the pavement across the entire width of the sweeping head, regenerative air sweepers tend to do a more effective job of cleaning over the entire pavement surface covered.

The optimum frequency of sweeping is discussed extensively in the literature, although there does not appear to be full agreement on the issue (EOA and Geosyntec 2011). Most sources conducted sweeping tests with a bi-weekly or a weekly schedule, although one study examined a frequency of three times per week (Pitt 1985) and for another, a frequency of five times per week (Pitt and Shawley 1981). A study by the City of San Diego (Weston Solutions 2010) found that increasing sweeping from once to twice per week with a vacuum sweeper did not increase the amount of material collected; however, this was not the case for mechanical sweepers, which showed a lower volume of collected material with the increased frequency.

The ideal goal is to sweep prior to a forecasted storm with as little lag time as possible, but this is difficult given logistical and resource constraints. Some references suggest that the frequency of sweeping should be set to conduct, on average, one or two sweepings between storms. In semi-arid climates, some references recommended more intensive sweeping prior to the onset of the wet season. Given the potential for street dirt to blow off the bridge deck and directly into the receiving water, more frequent sweeping is likely beneficial.

Southerland (2013) recommends a site-specific investigation using a calibrated model to determine an optimum sweeping schedule, but notes that it will likely be in a range from about 17 sweepings per year to 52 sweepings per year. In general, for maximum particle removal, sweeping frequency should be increased until there is a decrease in the mass of material removed per curb mile.

Pavement conditions are known to significantly affect the pickup performance of street cleaners (Sartor and Boyd

1972). Street sweepers have considerable difficulty effectively picking up particulate material from streets whose pavements are classified as poor, because this usually indicates the presence of significant surface cracks and deep depressions where dirt can accumulate. The uneven surfaces that accompany poor pavement conditions make it difficult for the sweepers to operate effectively, especially the newer regenerative air machines.

The forward speed of a street cleaner while sweeping will significantly affect its ability to pick up particulate material. Other factors being equal, the pickup effectiveness increases as the forward speed decreases (Sartor and Boyd 1972); however, the URS study (2011) did not find that speed (within a defined range) had a significant influence on material pickup for mechanical sweepers. The optimum average forward sweeping speed is believed to be approximately 5 miles per hour. This is good balance for the tradeoff between pickup performance effectiveness and the need to sweep a reasonable length of streets in a given day. Southerland (2013) reports that sweeping in the range of 8–10 mph reduces particulate pickup performance by 10–15% compared to the optimum average speed.

There are two main areas of research regarding street sweeping effectiveness. The first of these is the amount of material removed from the street and the factors that influence sweeping effectiveness. The second area of research focuses on whether removal of street dirt and associated pollutants has any impact on runoff quality.

EOA and Geosyntec (2011) reviewed a number of street sweeping studies and developed Figure 4-3 to compare the observed removal efficiencies. Removal efficiencies of the material accumulated on the street varied from about 20% to 70% depending on the type of sweeper evaluated and the pavement condition. Other factors being equal, the regenerative air sweepers and vacuum-assisted sweepers were shown to be more effective. These results were confirmed by the results of the City of San Diego study (Weston Solutions 2010).

The removal of sediment is important, but other pollutants of concern are metals and potentially bacteria. No studies were identified that examined street sweeping as a practice to remove bacteria from paved surfaces. In the environment, bacteria are generally associated with the smallest size fraction of particles, which are removed least effectively by street sweeping programs. Consequently, bacteria removal efficiency may be only 10–50% of that observed for sediment.

Several studies were identified that evaluated removal of other pollutants through street sweeping. Kurahashi and Associates (1997) reported 45–65% removal of total suspended solids, 30–55% of total phosphorus, 35–60% of total lead, 25–50% of total zinc, and 30–55% of total copper. Montgomery County Department of Environmental



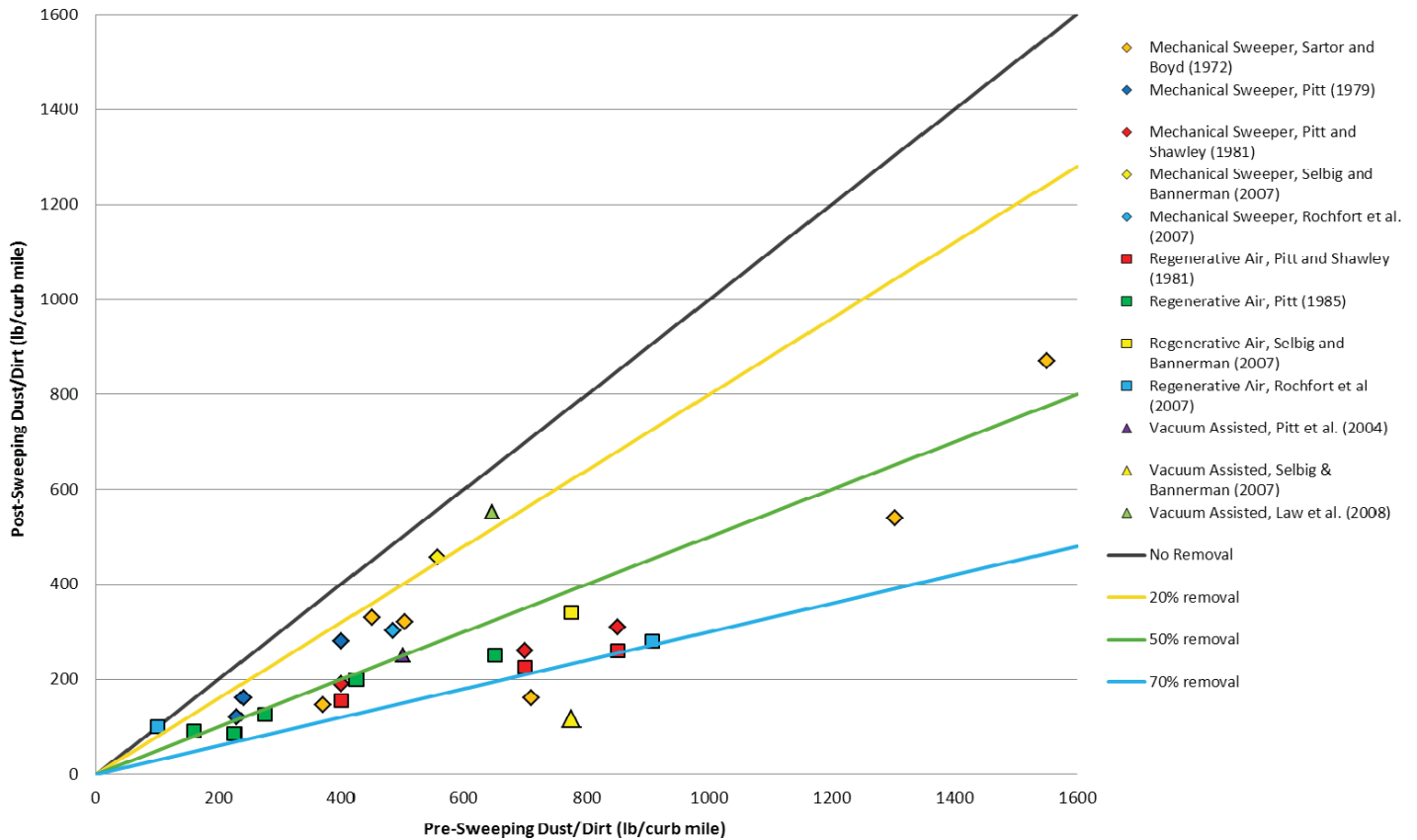

**Figure 4-3. Comparison of pre- and post-sweeping solids data. From the various street-sweeping studies reviewed, in the form of lbs of solids per curb-mile (EOA and Geosyntec, 2011).**

Protection (2002) provided removal effectiveness data from studies performed by the Center for Watershed Protection. Total suspended solids reduction ranged from 5% (major road) and 30% (residential street) for mechanical sweepers to 22 and 64%, respectively, for regenerative air and 79 to 78%, respectively, for high-efficiency vacuum sweepers. Law et al. (2008) also developed estimates for percent total solids and nutrient removal (Table 4-2).

Southerland (2013) reports that street sweeping operations have the ability to remove bioavailable or soluble metals before they are wetted by rainfall and dissolve. The street dirt with a size less than about 2,000 microns accounts for over 80% of the total particle mass.

#### 4.4.5 Scupper Plugs

One relatively simple alternative management technique available for use on urban bridges that span impaired water bodies is scupper plugs. This technique is in use by the Oregon Department of Transportation; more information can be found at: [http://www.fhwa.dot.gov/environment/wildlife\\_protection/index.cfm?fuseaction=home.viewArticle&articleID=62](http://www.fhwa.dot.gov/environment/wildlife_protection/index.cfm?fuseaction=home.viewArticle&articleID=62)

Scupper plugs are formed by maintenance crews from fast-setting grout or spray foam and used to close off drainage openings on existing bridges. The plugs prevent solids during dry weather from discharging into the receiving water. Their

**Table 4-2. Estimated total solids and nutrient removal (percent).**

Frequency	Technology	TS	TP	TN
Monthly	Mechanical	9	3	3
	Regenerative Air/Vacuum	22	4	4
Weekly	Mechanical	13	5	6
	Regenerative Air/Vacuum	31	8	7

**Table 4-3. Constituent concentrations in stormwater runoff for swept and unswept roadways.**

Storm Event	Type of Sweeping	Copper (µg/L)	Lead (µg/L)	Zinc (µg/L)	TSS (µg/L)
12/07/2009	Unswept	143.0	71.8	1,689.4	703.8
	Mechanical	50.9	30.7	443.6	112.8
	Vacuum	51.2	22.3	362.7	130.2
1/18/2010	Unswept	218.4	234.0	1,210.9	1,719.6
	Mechanical	83.1	77.8	610.1	431.6
	Vacuum	34.1	23.5	307.6	145.2
2/5/2010	Unswept	73.7	59.2	452.1	357.6
	Mechanical	55.4	38.5	353.8	187.1
	Vacuum	39.4	15.2	366.1	132.0
Mean of Three Storms	Unswept	145.0	121.7	1,117.5	927.0
	Mechanical	63.1	49.0	469.2	243.8
	Vacuum	41.6	20.3	345.5	135.8

primary use is on bridges where there is sufficient longitudinal slope to avoid flooding the travel lane if the scuppers are plugged during runoff. For bridges that require the scuppers to fulfill dry lane criteria, maintenance crews must quickly remove the plugs to allow for drainage if a storm is forecast. This is an approach that, for practical reasons, would be limited to only existing bridges crossing highly sensitive receiving waters. Sweeping should be performed prior to removal of scupper plugs.

#### 4.4.6 Summary

The focus of a street sweeping program should be on bridges that have a solid bridge rail. Bridges without a solid railing wall are unlikely to accumulate much material since it will be mobilized off of the bridge by traffic induced wind currents. The frequency of sweeping can be optimized by recording the mass of material collected in the sweeper, and increasing the sweeping frequency until a decline in the mass is detected per curb mile. This is an indication that the frequency exceeds the time for equilibrium build-up, and that more frequent sweeping would have only marginal benefit.

Modern equipment will perform best. Regenerative air sweepers exhaust less particulate material than vacuum sweepers, and have about the same performance, so they are preferred. Optimum speed is 4 to 6 mph, but operating at 10 mph is an appropriate trade of time vs. efficiency. The condition of the bridge deck is also important. Rough or uneven surfaces will retain particulates with less sweeper efficiency. Optimum conditions have low humidity and moisture on the pavement.

Weston Solutions (2010) reports the effectiveness of sweeping in Table 4-3. The “unswept” column refers to streets that were swept once every two months prior to the storm event. The other rows indicate the type of sweeping performed once per week for three weeks prior to the sampling event. Ten stormwater runoff samples were collected for each event at each site, and the final row represents the mean of three sampled storm events.

## 4.5 Bridge Inspection

The AASHTO *Manual for Condition Evaluation of Bridges* is recognized as a national standard for bridge inspections and load rating. The routine structural inspection frequency is 24 months unless FHWA approval is given for a 48-month cycle. Elements of the AASHTO *Manual for Condition Evaluation for Bridges* that directly or indirectly relate to bridge source control and operational best management practices are as follows:

- Substructure inspection requirements for abutments and piers
- Superstructure inspection of painted components
- Drainage systems within the deck and approach areas

The AASHTO *Manual for Condition Evaluation for Bridges* requires inspection for significant scour or undercutting of abutment areas. If the abutments are submerged in water, then probing is also normally performed. The inspector is required to identify instability of slope areas and accumula-

tion of sediment. Measures similar to abutments are required for the inspection of piers. If riprap has been used as a countermeasure against pier scour, then it should be inspected for stability and adherence to original design specifications (i.e., size and angularity). Steel piers should also be inspected for signs of corrosion. Painted areas are required by AASHTO to be inspected for signs of rust, chalking, pitting, crazing, and staining.

AASHTO requires drainage systems within the deck and approach areas to be inspected for adequacy and physical condition. Grating over deck drains must be observed as physically intact. Missing or broken grates must be documented. Clogged deck drains or scuppers are to be identified and documented. Down drains are to be inspected to confirm that they terminate at splash blocks or other suitable facilities to prevent erosion or structural undermining. Areas of ponding water are also to be identified and documented. Unintended discharge of water through cracks, joints, spall areas, etc. must also be identified. Drainage within the bridge approach must be inspected to verify that runoff does not bypass and cause erosion of embankment fill areas.

In addition to protocol established by AASHTO, the practitioner should consider the following enhancements as part of a comprehensive “Bridge Stormwater Conveyance and

Collection System Assessment” program for routine and post storm inspections:

1. Identify and document existence of trash and debris. Remove and dispose of this in a suitable manner based upon the material type.
  2. Identify and document buildup of sediment or ponding water within riprap pad areas, or evidence of scour at the downstream end. Identify and document any occurrences of riprap material transport.
  3. Inspect drainage pipes, inlets, and structural BMPs (as applicable) for presence of stagnant water and maintenance needs.
  4. Identify and document occurrences of flaking or dislodging paint into or near the receiving waters.
  5. Verify the functionality of temporary drainage blocks such as scupper plugs, or non-traditional drainage inlets such as offset deck drains and raised scuppers.
  6. If bird nets are being used, check to ensure they are not torn or clogged with dirt or debris. If bird spikes are used, check similarly to ensure they have not experienced buildup of debris or dirt.
  7. Check bridge decks after snowstorms for excess residual sand or salt deposits. Wash or sweep in accordance with the practices discussed in this chapter.
-

## CHAPTER 5

# Stormwater Treatment Controls for Bridges

This chapter describes the treatment BMPs that the practitioner can consider when treatment of deck runoff is required by the regulatory agency. Installation of treatment BMPs should be reserved for situations where the DOT is required to provide them as part of an MS4 NPDES permit designation, or pursuant to a Section 401 Water Quality Certification, and/or based upon an assessment that considers other special receiving water conditions such as TMDLs, presence of endangered species, the protection of outstanding natural resource waters (ONRW) or domestic water supply reservoirs. Implementation of treatment controls for bridges should be done in concert with other applicable minimum source and operational control measures discussed in Chapter 4. The treatment controls available include BMPs located at the abutment and within the deck area itself. There are many comprehensive references (including NCHRP publications) on BMP selection and design for highways. However, the information provided in this chapter focuses on providing the practitioner with the details needed to understand and evaluate the cost efficiency of the treatment BMPs that are included in the BMP evaluation Tool. These BMPs can be considered for new construction and retrofit situations. Various types and options for deck drainage conveyance are also discussed as an important consideration in bridge design, cost, long-term maintenance, and as an influencing factor on the stormwater treatment approach. The treatment BMPs discussed in Section 5.3 of this chapter generally require conveyance of the deck runoff to the abutment for treatment, with several exceptions—one being PFC overlay, and the others involving potentially promising concept technologies. Another relevant and potentially cost effective option involving treatment BMP installation at offsite terrestrial roadway locations is discussed in Section 5.4.

Operational and structural spill controls are also discussed in this chapter. Historical evidence has shown that probability of spilling a hazardous chemical over a sensitive receiving water is remote and is best handled by first-responders to

contain the pollution. Despite this fact, the construction of capital improvements to contain a spill may be warranted in certain instances and the guidelines associated to apply such an approach are discussed in Section 5.4 of this chapter.

## 5.1 Tool Overview

The spreadsheet Tool accompanying this guide was developed around five treatment BMPs that are suitable for use at the abutment and one that can be used on the bridge deck:

### Use at the abutment:

- Swales
- Dry detention basin
- Bioretention
- Media filter

### Use on the bridge deck:

- PFC

Other BMPs the practitioner can consider are also discussed in this section, but not modeled by the spreadsheet tool, due to lack of cost and performance data. However, they are included in this guide as an option for the practitioner to evaluate.

The selection of a BMP will largely be based on the physical constraints in the abutment area. The BMPs modeled by the tool were selected because they have relatively flexible siting criteria, can operate under a variety of conditions, and have been shown to be effective for constituents of concern in highway runoff. Siting and design guidance are provided in the sections that follow. The tool can be used to develop performance and whole life cost data for the selected BMP. The tool is also useful for comparing the BMPs and selecting the one with the highest performance at the lowest life cycle cost. Treating bridge deck runoff at the abutment will require conveying runoff to the abutment. The practitioner can select

**Table 5-1. Constituent concentration and load calculations.**

Total Suspended Solids (mg/L)
Total Zinc (ug/L)
Total Lead (ug/L)
Total Copper (ug/L)
Total Nitrogen (mg/L)
Total Phosphorus (mg/L)
Nitrate [NO <sub>3</sub> ] (mg/L)
Total Kjeldahl Nitrogen [TKN] (mg/L)
Dissolved Phosphorus (mg/L)
Fecal Coliform (col/100mL)
<i>Escherichia Coli</i> [ <i>E. Coli</i> ] (col/100mL)

a conveyance system cost for their bridge in a separate spreadsheet tool (included as a separate file from the BMP evaluation tool). Guidance for developing the BMP cost using the tool is provided in Appendix E: BMP Evaluation Tool Modeling Methodology. The conveyance system may consist of a system of deck drains connected to pipes that convey runoff to the abutment(s). Alternatively, runoff conveyance may be provided by the bridge deck, as long as the spread criteria are maintained for the traveled way. Section 5.2 discusses an alternative design approach of offsetting the deck drains from the bridge rail wall to allow the water quality design flow to pass the deck drain, with excess flow entering the drain. This may be an economical way for some bridge installations to convey runoff to the abutment without a closed conduit piping system by using the planned deck shoulder area for conveyance of the water quality flow.

The tool accompanying this guide can be used to estimate the influent concentration and load for many of the constituents of concern, as well as the effluent quality from the selected BMPs. The tool computes influent and effluent quality for the constituents listed in Table 5-1.

For those constituents not listed, proxies may be used to estimate effluent concentrations. For example, total metal removal may be similar for specific metals not computed by the tool. If the influent concentration of the metal is known, the effluent quality may be estimated from an average of reductions observed for the listed metals as computed by the tool. A similar approach can be used for other dissolved and particulate constituents.

## 5.2 Bridge Deck Conveyance Systems

The purpose of bridge deck conveyance systems in the context of this study is to transfer deck runoff to the abutment for treatment. This can be accomplished using a wider deck area that includes a shoulder to convey runoff to the abutment, or one with a comparatively narrower deck that incorporates a piping system serving bridge deck drains. This

section will discuss the technical merits of each approach, the challenges of each approach, as well as operation and maintenance considerations. The maximum spread allowed in the shoulder of the bridge is termed the design spread and generally coincides with the width of the shoulder without encroachment into the traffic lane. Bridge decks can be difficult to drain and meet the standards of the DOT for spread as well as maximum depth of transverse sheet flow because of relatively low cross slopes, bridge railing walls or parapets that collect debris, bridge deck drains and associated piping that are comparatively small, and the resulting potential for clogging of inlets and drainage systems. These issues directly impact the project economics and practicality of various options for runoff treatment as well as the ability to achieve the lowest whole life cost.

FHWA (1993) describes how the requirements in the design of deck drainage systems differ from roadway drainage systems:

- Total or near total interception may be a desirable upstream of expansion joints.
- Deck drainage systems are susceptible to clogging.
- Inlet spacing is often predetermined by bent spacing or piers.
- Inlet sizes are sometimes constrained by structural considerations.

There are a variety of design concepts involving bridge deck inlets and scuppers. Bridge scuppers are defined within this report as openings in the rail or parapet wall to let runoff discharge over the side of the bridge. Deck drains connect to a pipe that discharges at the bridge soffit, through a column or pier wall, or through the bridge superstructure to the abutment. Runoff collected in the deck drain enters the pipe and is conveyed to the desired outlet location. Pipe sizing in such systems is usually dictated by hydraulic limitations created by the interception capacity of deck drains. Because of the impact on capital costs and increased difficulty involved with maintenance, direct discharge is preferred over pipe collection systems. Figure 5-1 shows a typical deck drain.

Bridge deck inlets are generally fabricated from ductile cast-iron or welded-steel chambers. By contrast, roadway drains are much larger pre-cast, cast-in-place, or masonry structures. Iron is rarely a pollutant of concern for bridge runoff. However, many states require all their metal drainage hardware to be galvanized. Galvanizing is the most popular finish, but it is expensive and can contribute zinc to runoff. Exposed galvanized components of the drainage system should be avoided. Painting of deck inlets is less expensive than galvanizing. In most locations, painted deck inlets will perform as well as galvanized boxes (Copas and Pennock 1979). For severe duty conditions, epoxy coating can be considered. Piping systems for bridges are typically steel conduits that must



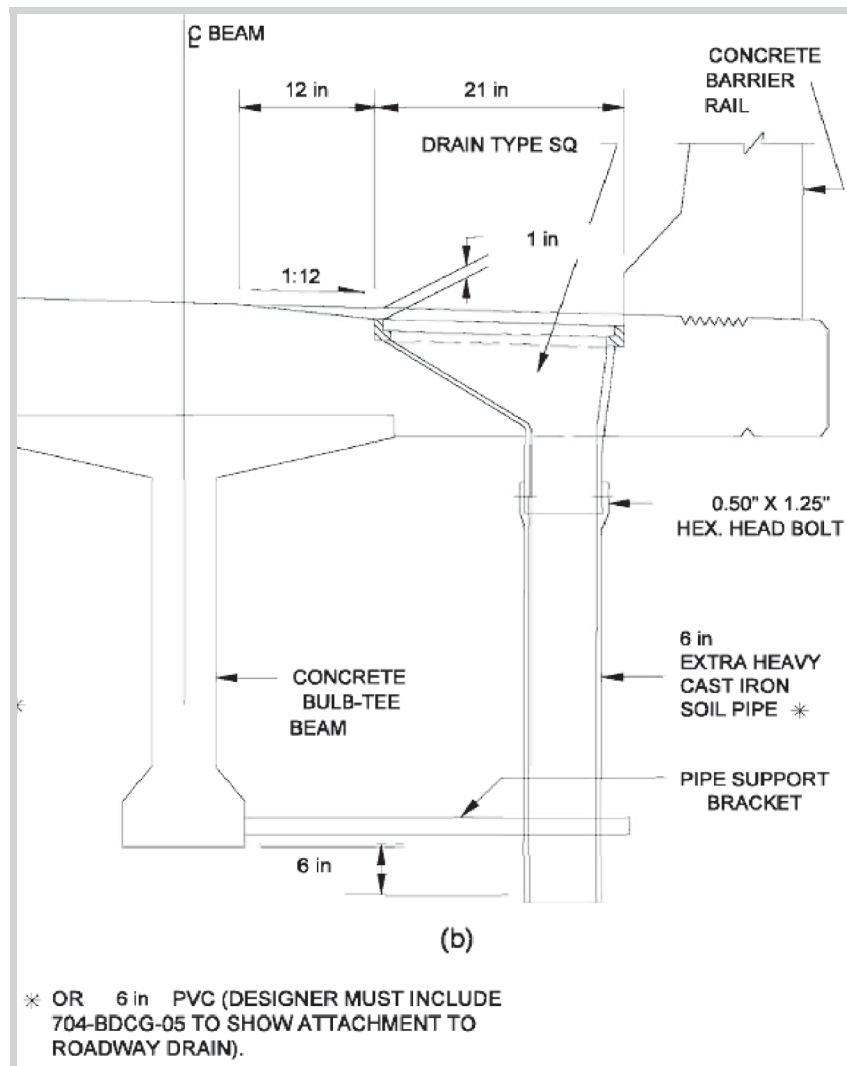

**Figure 5-1. Deck drain.**

withstand vibrations and deflections. Fiberglass and PVC conduits are sometimes specified since they avoid contributing iron or zinc to runoff within the bridge conveyance system and are more flexible than steel and, as such, can better withstand the displacement and associated stresses within a bridge superstructure. They also have the advantage of being inert to oil, gas, salt, ice melting chemicals, and low pH runoff. However, exposed fiberglass and PVC piping should be painted to limit UV exposure. The design of deck drainage systems must consider pollutant-generating potential, the aesthetics, and maintenance requirements of the conveyance system materials and finishing.

The Guide Tool (a separate spreadsheet from the BMP Tool) computes the cost of the conveyance system based on bridge deck area, for three designated levels of drainage system complexity. A description of the three cost levels is provided in Chapter 6. Costs are not calculated in the Tool for a system that uses a larger deck area or a combination of deck area

and scuppers. If appropriate, additional bridge deck area cost would need to be computed separately by the practitioner.

### 5.2.1 Offset Deck Drain and Raised Scuppers

Offset deck drains and raised scuppers are new and relatively untested approaches that may effectively collect and convey runoff from small to mid-size bridge projects that are subject to treatment standards of an NPDES permit or Section 401 Water Quality Certification. Offset deck drains are located at a strategically determined horizontal offset from the bridge side railing. Raised scuppers are vertically raised from the flow line of the bridge deck. Both design approaches allow the standard water quality flow rate to bypass the deck drain or scupper system. Bypass will occur for flow rates at or below the water quality flow rate and will be collected prior to reaching the deck joint in an inlet system, from which point runoff

is piped to a suitably sized treatment BMP. The advantage to this approach is that the length of conveyance pipe can be kept to a minimum along portions of the bridge directly over water (which will typically represent the majority of the structure). The practitioner will be required to determine spacing, offset, and other dimensional details based upon the bridge length, longitudinal gradient, cross slope, and the local water quality and flood flow rates. Since the amount of bypass will accumulate along the length of the bridge deck, the offset of deck drains must be designed to increase proportionately along the direction of flow to accommodate an increasing spread. Similarly, the height of raised scuppers above the deck must also be designed to increase along the direction of flow. For this reason, implementation of this approach on large or unusually long bridges with flat decks may be impractical. Scuppers or deck drains must also allow for clear travel during flood conditions based on local DOT dry lane standards. Sample relationships between drain spacing, flood encroachment, and longitudinal deck slope are provided for a 1,000-foot example bridge with a 2% cross slope and a water quality flow rate of 0.5 inch per hour. The flooded condition is assumed to produce flow rates at 10 times the water quality storm.

Table 5-2 indicates that in many circumstances, scuppers raised within a range of 0.03–0.15 feet (0.36–1.8 inches), or deck drains offset 1.5–7.5 feet from the side rail would be effective in allowing water quality flow rates to bypass a direct discharge to the receiving water, although the limitations on flatter decks (0.5% to 1.0%) is very apparent. A comparison of required head versus allowable head also shows that typical deck drain sizes may have difficulty in capturing flood surcharge within the limit of an 8-foot shoulder at or near the abutment. In these instances, where reduced spacing is not practical, increasing the number of deck drains, providing local inlet depression, and/or using raised scuppers may be more appropriate.

### 5.3 Treatment Controls

Treatment BMPs for runoff from bridge decks can be classified into two general categories: treatment on the bridge deck itself and treatment at the abutment. BMPs located at the abutments will require a conveyance system to transfer the deck runoff to the abutment area and the BMP. BMPs on the bridge deck do not require a conveyance system, but will require maintenance of the BMP on the bridge structure. The BMPs for bridge runoff treatment addressed in this guide are as follows:

#### Treatment at the abutment:

- Swales
- Dry detention basin
- Bioretention
- Sand filter

#### Treatment on the bridge deck or bridge structure:

- Bridge scupper treatment
- PFC
- Floating pile wetland

### 5.3.1 Treatment at the Abutment

Treatment BMPs at the bridge abutment will require sufficient right-of-way to construct the BMP and provide maintenance access (which can be very limited or not available) and a suitable discharge location. Flow from the bridge deck also must be conveyed to the abutment either along the bridge deck or through a pipe system to the abutment area. Prior to selection of abutment treatment BMPs, the additional costs for pipe conveyance systems or additional deck area for runoff conveyance to the abutment should be evaluated.

Construction of treatment devices within the floodplain will have regulatory and operational considerations. Improvements that modify the extent or elevation of the floodplain must be submitted for approval by the local floodplain administrator to FEMA. Area under bridges may also be subject to requirements of the Rivers and Harbors Act. Further, if the BMP is located in the floodplain, it should be designed to ensure that it is not damaged, and will not release pollutants during periods of inundation through re-suspension of accumulated sediment or scour. In general, ensuring that BMPs are above the bank full event is a good minimum standard. Engineering hydraulic analysis of BMP performance during flood events is recommended in the interest of preventing adverse water quality impacts and ensuring a reasonable service life for the BMP.

Opportunities to treat runoff from an existing at-grade section of the roadway near the bridge (that is currently untreated), which can be considered in lieu of treating runoff from the bridge, should be assessed. If acceptable to the regulatory agency, treating off-bridge highway runoff could potentially be a more cost-effective alternative with greater benefits to the receiving water.

The BMPs described in this guide for treatment at the abutment represent the primary, non-proprietary BMPs typically used by DOTs for concentrated flows and can operate passively with extended maintenance intervals. All are proven BMPs that have had substantial study to assess pollutant removal effectiveness and whole life costs. Other BMPs may also be used at the designer's discretion, but the selected BMPs are those available in the BMP Evaluation Tool (see Chapter 6) to allow the designer to evaluate the BMP selection based on performance and whole life cost.

#### 5.3.1.1 Swales

Swales are vegetated stormwater conveyances that treat runoff by filtration, shallow sedimentation, and infiltration

**Table 5-2. Representative spacing of offset deck drains and raised scuppers.**

Bridge 1/2 Width (ft)	Longitudinal Slope (%)	Deck Drain/Scupper Spacing (ft)	Water Quality Flow (cfs)	Surcharge (Bypass) Flood Flow at Each Inlet (cfs)	Water Quality Event		Flood Event		
					Flow Depth (ft)	Flow Spread (ft)	Assumed Effective Deck Drain Size	Required Head for Surcharge Flow (ft)	Allowable Head for Dry Lane Near Abutment (ft)
20	0.5	30	0.01 – 0.23	0.07	0.03 – 0.10	1.50 – 5.00	1' x 1'	0.056	0.060
20	1	50	0.01 – 0.23	0.11	0.03 – 0.04	1.50 – 2.00	1' x 1'	0.059	0.120
20	3	100	0.02 – 0.23	0.23	0.03 – 0.04	1.50 – 2.00	1' x 1'	0.063	0.120
40	0.5	10	0.01 – 0.46	0.05	0.03 – 0.13	1.50 – 6.50	1' x 1' (2 each w/depression)	0.020	0.030
40	1	30	0.01 – 0.46	0.14	0.03 – 0.11	1.50 – 5.50	1' x 1' (2 each)	0.050	0.050
40	3	100	0.05 – 0.46	0.46	0.03 – 0.04	1.50 – 2.00	1' x 1'	0.082	0.120
60	0.5	15	0.01 – 0.69	0.10	0.03 – 0.15	1.50 – 7.50	1' x 1' (4 each w/depression)	0.010	0.010
60	1	30	0.02 – 0.69	0.21	0.03 – 0.13	1.50 – 6.50	1' x 1' (2 each w/depression)	0.020	0.030
60	3	30	0.02 – 0.69	0.21	0.03 – 0.11	1.50 – 5.50	1' x 1' (2 each)	0.046	0.050

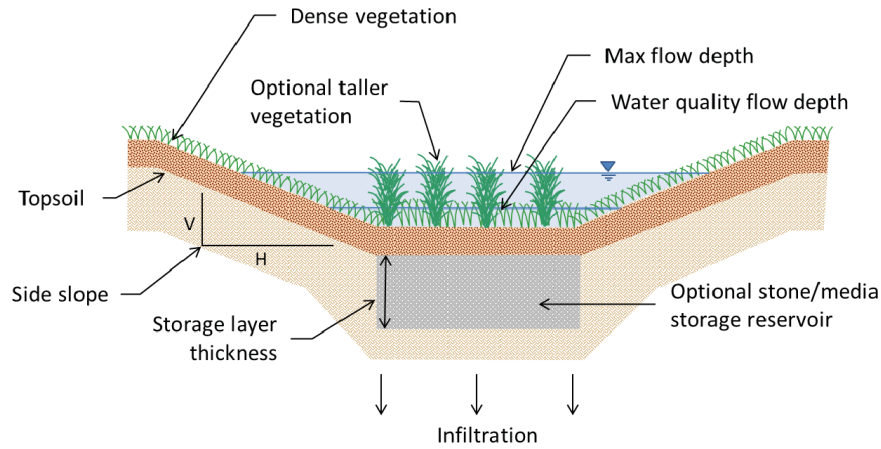

**Figure 5-2. Vegetated swale schematic.**

(Figure 5-2). Additional minor removal mechanisms include biochemical processes in the underlying planting media such as adsorption and microbial transformations of dissolved pollutants. Swales provide removal of suspended solids, oil and grease, and metals, in addition to reducing stormwater peak flow. Swales provide limited volume reduction and removal of nutrients and bacteria. The practitioner should take care to ensure that if a swale is used in the floodplain, it would not be scoured during rare events.

Primary swale features include:

- Dense vegetation layer
- Topsoil layer
- Optional taller vegetation (height can exceed the design flow depth)
- Optional stone or media storage reservoir

Typical swale design considerations include:

- Slopes
  - Width and side slope should be chosen such that flow depths in the vegetated swale do not exceed a recom-

mended depth of 4 inches. Ideally flows should be at least 2 inches less than grass height

- Recommended longitudinal slope of the vegetated swale is between 1% and 2.5%
- Design Flow Rate
  - Design flow velocity should not exceed 1 ft/s to keep the vegetation upright and promote sedimentation

### 5.3.1.2 Dry Detention Basin

Dry detention basins are storage BMPs intended to primarily provide peak flow reduction and sedimentation treatment (Figure 5-3). Dry detention basins do not have a permanent pool; they are typically designed to detain stormwater for an extended period for peak flow control (e.g., 36 to 48 hours from full condition) and then drain completely between storm events. The side slopes, bottom, and optional forebay of dry detention basins are typically vegetated. Dry detention basins provide efficient removal of sediments, oil and grease, and particulate-bound pollutants and, where soil conditions allow, can provide substantial volume reduction benefits with infiltration. Dry detention basins have limited ability to remove dissolved pollutants such as metals, nutrients, and bacteria.

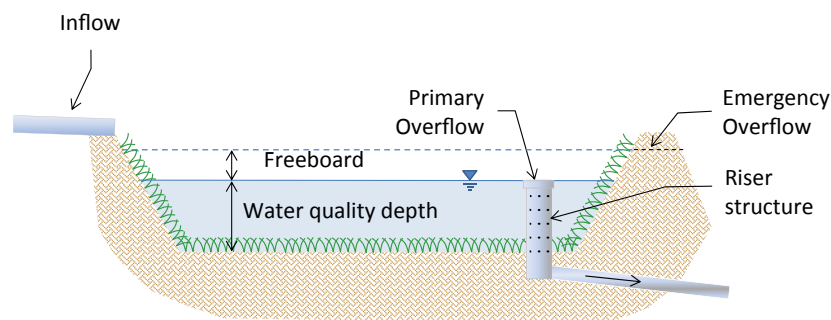

**Figure 5-3. Dry detention basin schematic.**

Primary dry detention basin features include:

- Optional sedimentation forebay
- Main basin
- Optional low flow channel—a narrow, shallow gravel-filled trench that runs the length of the basin to drain dry weather flows
- Typical dry detention basin design considerations include:
  - Space allocation: Consider side slope, maximum depth, and forebay requirements to determine space needed
  - Outlet design: The outlet should preferably be designed to release the bottom 50% of the detention volume (half-full to empty) over 24 to 32 hours, and the top half (full to half-full) in 12 to 16 hours.
  - Maintenance access: The basin should be large enough to allow for equipment access via a graded access ramp.
  - Vegetation: The bottom and slopes of the dry detention basin should be vegetated.

### 5.3.1.3 Bioretention

Bioretention systems (a.k.a. rain gardens) are vegetated shallow depressions filled with an engineered media used to temporarily store stormwater prior to infiltration, evapotranspiration, or discharge via an underdrain or surface outlet structure (Figure 5-4). By filtering stormwater through an engineered soil mix, bioretention systems can be designed to target a variety of pollutants. Removal of contaminants occurs primarily through filtration, shallow sedimentation, sorption, and infiltration. Additional removal mechanisms include biochemical processes in the underlying engineered planting media such as adsorption and microbial transformations of dissolved pollutants. Bioretention systems remove suspended solids, metals, oil and grease, nutrients, and bacteria, while also reducing volume and peak flow.

Primary bioretention features include:

- Stones near the inlet for energy dissipation
- Shallow mulch layer at the surface
- Medium thickness soil layer below the mulch
- Optional stone storage layer below the engineered soil layer
- Optional underdrain (needed when infiltration rates are low or infiltration is not desired). Upturned elbow to promote infiltration and nitrification
- Overflow outlet

Typical bioretention design considerations include:

- Drawdown Time: Drawdown time of planting media should be less than a few hours
- Ponding Depth: Recommended maximum ponding depth is 12 inches
- Planting Media:
  - Recommended minimum planting media depth is 2 feet (3 feet preferred)
  - Recommended planting media composition: 60 to 70% sand, 15 to 25% compost, and 10 to 20% clean topsoil; organic content 8 to 12%; pH 5.5 to 7.5

Compost for bioretention systems will need to be selected based on local conditions to minimize leaching of nitrogen and phosphorus to groundwater and/or receiving waters.

### 5.3.1.4 Sand Filter

Sand filters treat stormwater runoff via sedimentation, entrapment, and straining of solids (Figure 5-5). As stormwater passes through the sand filter bed, pollutants are trapped in the small pore spaces between sand grains or are adsorbed to the media surface. Sand filters efficiently remove sediments, oil and grease, metals, and bacteria, as well as reduce peak flow. Sand

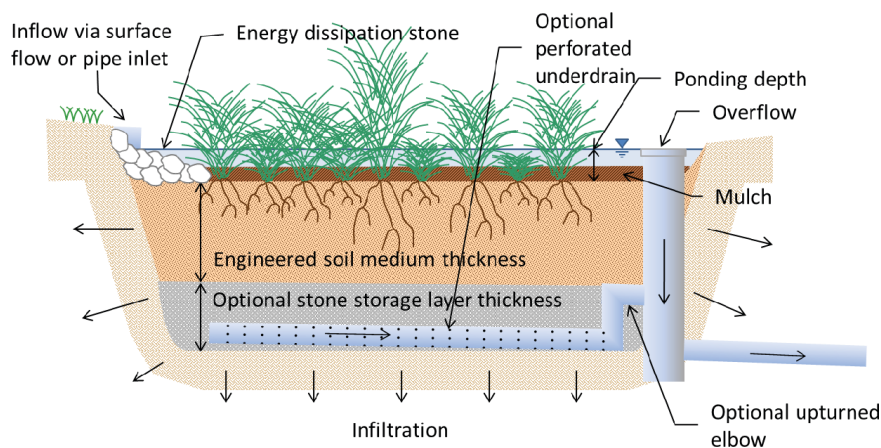
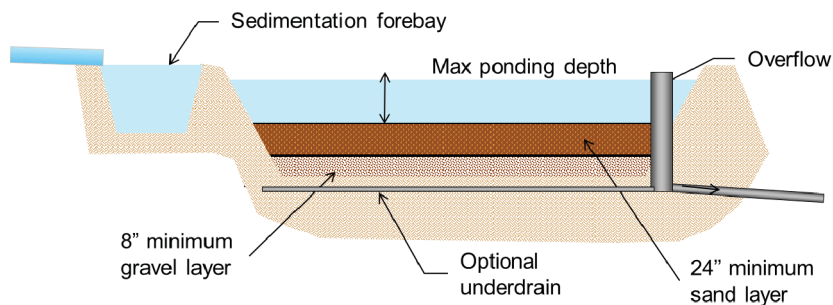

Figure 5-4. Bioretention schematic.





**Figure 5-5. Sand filter schematic.**

filters provide limited nutrient removal and volume reduction benefits. They typically include a constructed sand bed that receives runoff that spreads over the surface. The sand bed can be contained with a concrete structure; however, when sufficient right-of-way is available, design within an earthen containment is preferable. The treatment pathway is vertical (downward through the sand). Ponding on the surface occurs if inflows exceed the rate of percolation through the bed. A system of connected underdrain pipes under the sand bed collect and route flows that have percolated through the sand bed to the outlet.

Primary sand filter features include:

- Sedimentation forebay
- Sand filter bed
- Optional underdrain in stone trench below the sand filter bed

Typical sand filter design considerations include:

- Forebay: Recommended forebay size is 20–25% of total volume if no other pretreatment is provided
- Media filter bed: Recommended minimum media filter bed depth is 24 inches (36 inches or more preferred)
- Slope: Longitudinal slope along length of filter bed should not exceed 2%
- Ponding depth: Recommended maximum ponding depth above filter bed is 3 feet
- Underdrain: Underdrain should have a minimum diameter of 3 inches and 0.5% minimum slope

### 5.3.2 Bridge Scupper Treatment Concept

*NCHRP Report 767: Measuring and Removing Dissolved Metals from Storm Water in Highly Urbanized Areas* described a concept level design for treatment of bridge deck runoff specifically targeting metals removal. The concept design is based on the use of granular ferric oxide (GFO) material within a modified scupper to both filter runoff and sorb dissolved metals.

The media is housed in a modified bridge deck drain to serve a designated portion of the bridge deck area. Figure 5-6

shows a section of the concept bridge deck drain. The deck drain is designed for interception of the “water quality” design flow only, and must be followed downgrade by a deck drain designed to intercept the remaining drainage flow to maintain spread criteria.

The preliminary design procedure for the vault or inlet scupper is based on laboratory column tests. The media depth is fixed at a minimum value (10 inches), to achieve a minimum contact time with the media consistent with that obtained during the column testing (3 minutes). Thicker media depths may be used, but the required head should be computed using Darcy’s Law. The hydraulic conductivity of the media ( $K$ ) was determined to be 0.094 in./s. Caution should be used in developing designs with head requirements that are relatively large since the effective solids loading rate of the media will be higher, resulting in shorter runs between maintenance intervals due to possible media occlusion.

Hydraulic sizing computations should be based on a media-loading rate of 2 gpm/ft<sup>2</sup>, a media thickness of 10 inches, and a required head of 8 inches. The required amount of adsorptive media assuming a copper influent concentration of 10 µg/L, a target discharge copper concentration of 3 µg/L, and 30 in./yr of rainfall over a one-acre drainage is 72 kg/yr. The unit weight of GFO was measured as 40 lbs/ft<sup>3</sup>. The unit cost of GFO is about \$15/lb. This cost is likely to decrease for GFO purchased in bulk quantity, since \$15 represents the cost of the material obtained for the laboratory trials.

The crushed concrete/sand filter layer shown in Figure 5-6 is used to reduce the solids loading to the GFO media and extend the media life. Therefore, the anticipated change in permeability for the media over the operating life of the filter should be relatively small. The crushed concrete/sand layer and geotextile must be removed and replaced whenever the head requirements for the design flow become unacceptably high (exceed the top of the grate). Pre-treatment of flow is recommended to maximize the maintenance interval of the top layer and geotextile fabric. Oversizing the vault will also increase the maintenance interval, but the cost of the GFO media likely makes this option less desirable than a more effective pre-treatment system.

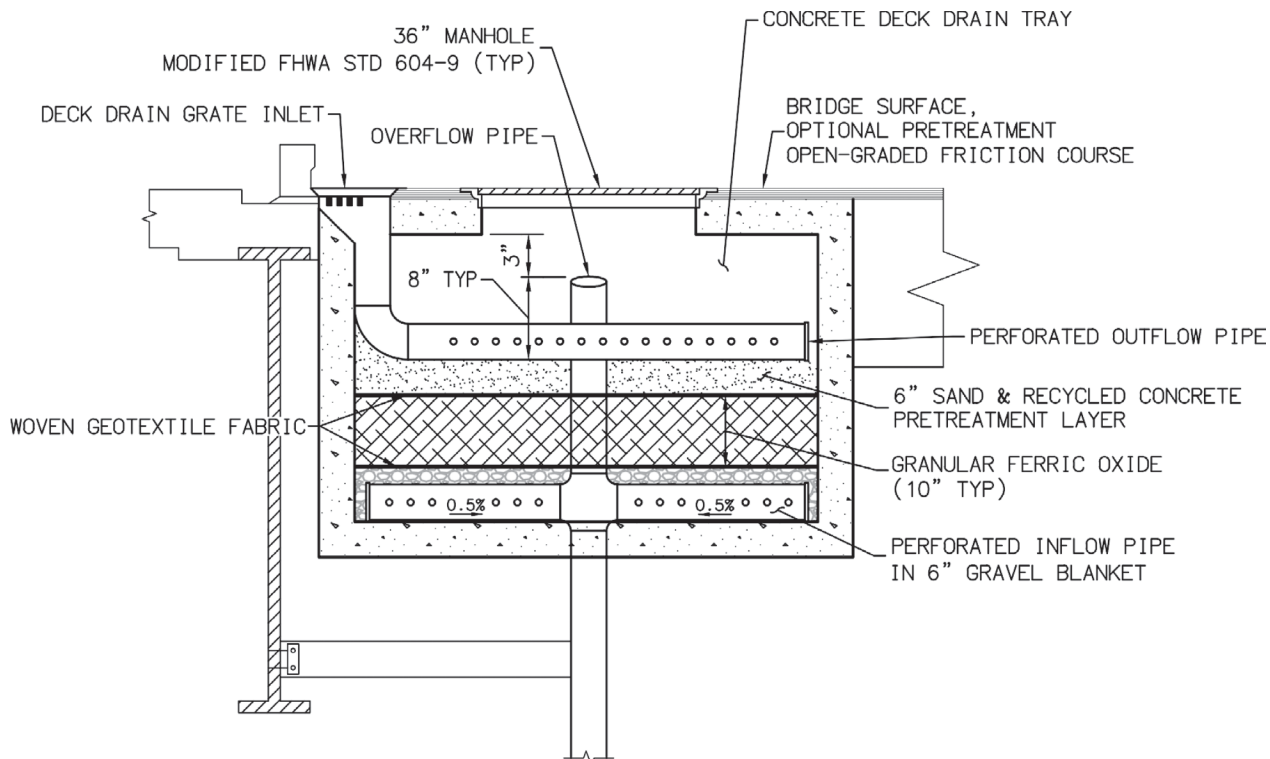

**Figure 5-6. Inlet deck drain with media.**

The custom bridge deck drain would be cast integrally with the bridge deck for concrete box girder and slab designs. Other design configurations would be required for steel bridges. Solids loading on bridge decks is generally consistent with at-grade roadways. Due to the relatively confined dimensions of the bridge deck inlet, pretreatment for solids removal on a bridge deck would be prudent. To reduce solids loading to the bridge scupper, a PFC overlay is recommended. As discussed in this chapter, PFC overlays have been shown to be effective in reducing TSS in highway runoff. The specific design will be based on local conditions, but the overlay should be discontinued at a distance from the bridge railing coincident with the edge of the scupper inlet to allow the flow within the overlay to collect in an effective “gutter” area. It is also recommended that a second scupper inlet be provided in the event that the treatment inlet becomes blocked with solids.

### 5.3.3 PFC

PFC is a layer of porous asphalt placed at thicknesses of 1–2 inches on top of conventional impermeable pavement, either PCC or AC. Older mix designs are termed OGFC. PFC is a type of porous pavement, but does not encourage infiltration and reduce runoff volume like full depth porous pavements used in parking lots. Instead, PFC layers remove rainfall from the highway surface and allow it to flow through the porous layer to the side of the road. By removing water

from the road surface, PFC improves safety by reducing splash- ing and hydroplaning (NCHRP 2009).

PFC could be considered as treatment BMP to avoid the cost of a bridge conveyance system. The PFC layer has been demonstrated to improve water quality (Barrett et al. 2006; Pagotto et al. 2000) as well as provide ancillary benefits such as reduced tire noise and improved visibility and stopping distance during rain events (McDaniel et al. 2010). Performance of the PFC overlay, in areas where a freeze thaw cycle occurs appears satisfactory, as reported by McDaniel et al. (2010), but some durability questions remain (Cooley et al. 2009). Placement of PFC on a bridge deck as a BMP would afford a DOT a logical pilot test site to understand site-specific design life and operational requirements while satisfying runoff treatment objectives.

Compared to other practices for treating highway stormwater, PFC has many advantages. The quality of water discharged from PFC into the environment is of comparable quality to a sand filter (Eck et al., 2012). However, unlike a sand filter or other conventional practices such as detention basins, bioretention, or filter strips, PFC incorporates stormwater treatment into the roadway surface and does not require additional right-of-way. Maintenance is also not required beyond the periodic milling and re-surfacing that occurs due to structural considerations. The milled PFC is commonly recycled into new conventional pavement, thus preventing any particulate matter retained by the pavement from entering the environment. As a pavement, PFC is more

expensive than conventional asphalt due to better aggregate quality, but when it is installed to reduce noise and improve wet weather drivability the water quality improvements are essentially free. The good quality of PFC runoff combined with the negligible land and maintenance requirements makes PFC a compelling choice for stormwater treatment in the high-speed highway environment.

### 5.3.4 Floating Pile Wetland

A floating pile wetland (Figure 5-7) is a management option for consideration in bridge projects that cross a perennial stream. Floating pile wetlands are a relatively new approach for managing runoff from DOT projects. There has been no known transportation pilot project application

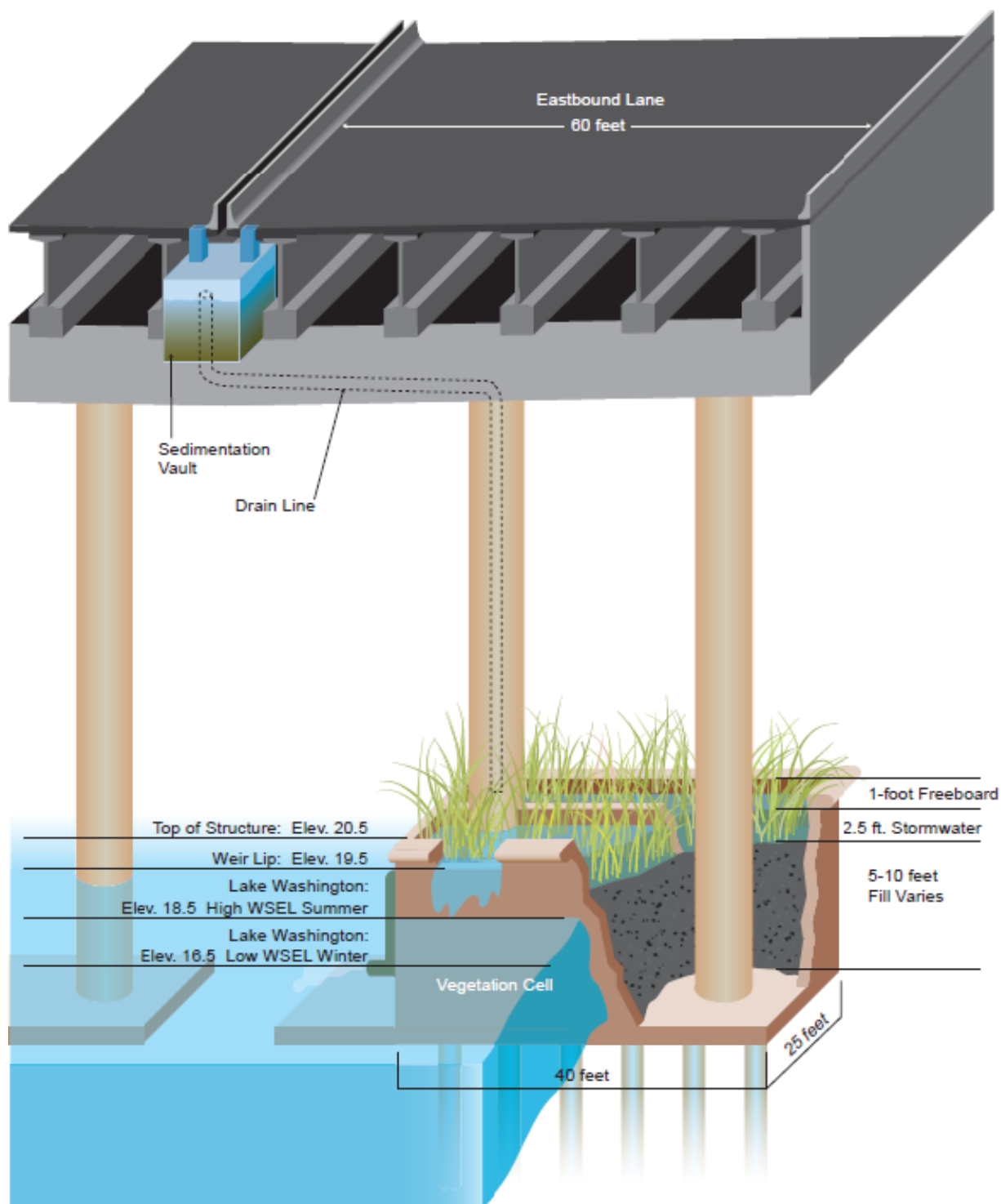

Figure 5-7. Floating pile wetland (from WSDOT).

of floating pile wetlands. The concept of applying floating wetlands within a transportation project was originally suggested by the WSDOT for the SR 520 bridge replacement and HOV project. However, floating wetlands have been constructed in other applications. For example, over 2,000 square feet of floating wetlands were constructed in the Baltimore Inner Harbor. In this application, the wetlands function to remove nutrients and other pollutants from the water, while providing oxygen and supporting beneficial micro-organism growth (Watershed Partner of Baltimore, Inc. 2014). For more information, the practitioner can refer to: <http://www.healthyharborbaltimore.org/whats-happening-now/floating-wetlands>

Floating pile wetlands appear to present applicability for bridge projects that rely on the use of piers in the structural design, but are limited spatially to provide treatment at the abutment area. Like any engineered wetland, floating pile wetlands can be an effective approach at managing soluble pollutants (i.e., soluble metals) generated on the bridge deck. Provision for a sedimentation chamber for pre-treatment within deck is recommended wherever feasible. Flow is intended to discharge through a down-drain system attached to the pier and into a wetland vegetation cell that is constructed within a surrounding concrete pile. The wetland is intended to operate above the seasonal high water mark of the surrounding river, with a constant ponding depth of several feet. Outflow from the wetland is achieved through a weir built into the side of the pile structure.

Much of the original design practice for constructed wetlands comes from municipal wastewater treatment, as opposed to urban runoff. In municipal wastewater application, ideal residence time is approximately 6 to 7 days (U.S. EPA Office of Research and Development 1988). Due to the inherently limited available storage volume that can be constructed within a typical bridge pier pile, traditional practices will likely require adaptation methods backed by research to determine an achievable residence time. Inadequately short residence times will sacrifice pollutant uptake, and inordinately long residence times can lead to stagnant anaerobic conditions. In addition to evaluating achievable residence and pollutant reduction, research should evaluate the influence of factors such as bed slope, plant type, temperature, and organic loading on performance. For more information regarding municipal design procedures for constructed wetlands, the practitioner can refer to <http://water.epa.gov/type/wetlands/upload/design.pdf>.

The practitioner should also consider some potentially significant limitations associated with floating pile wetlands including adequacy of year round water supply and increased pier scour. A properly functioning wetland system is assumed to require only nominal levels of inspection and maintenance; the degree of difficulty would vary substantially based upon the type and height of bridge as well as the size of the river.

### 5.3.5 Offsite Mitigation

There are a several reasons why offsite mitigation of the impacts of bridge runoff on receiving water quality is preferred. These include the cost and technical feasibility of retrofitting existing or constructing treatment controls for planned bridges; the fact that a significant portion of the contribution of pollutants from bridges to receiving waters actually occurs during dry weather through re-suspension; the lack of available space at the bridge abutment areas to construct treatment facilities; and the difficulty of providing routine maintenance for facilities installed on or near the bridge structure. Treatment of runoff from an adjacent terrestrial section of highway should result in higher pollutant load reduction as compared to treatment of the bridge deck runoff. Consequently, if treatment BMPs are required for bridge deck runoff, this guide recommends constructing the treatment device on a comparable section of untreated highway as the most effective and economical option.

Selection of offsite mitigation options can be complicated by a number of factors, such as legal restrictions on the use of highway money for projects not part of the road system, the lack of available space for construction of treatment facilities, and the need to collaborate with the public/local officials to obtain project approval. Consequently, it is important to prioritize the potential offsite opportunities to reduce the project cost and speed project delivery. The following ranking of offsite mitigation options is suggested:

1. Untreated runoff from DOT facilities in the watershed that discharge to the receiving water.
2. Small highly impervious catchments within the watershed of concern outside of the highway system.
3. Larger watersheds with less impervious cover outside the highway system within the same watershed.
4. DOT facilities outside the watershed.

Clearly, the highest priority for offsite mitigation would be other locations within the highway system (with similar AADT) that discharge untreated runoff to the receiving water of interest. Working within the highway system provides the DOT the ultimate flexibility in determining treatment facility siting, design, and maintenance. The ability to make these decisions unilaterally will substantially speed project delivery and allow the DOT to construct facilities that comply with the DOT's specifications. Retrofit of roadways for stormwater treatment can occur rapidly and without the need for additional right-of-way (ROW) by using PFC, where appropriate, based on climate and terrain.

Retrofitting a small, highly impervious catchment within the watershed, but off the highway system is the next best option. A catchment with characteristics similar to a bridge deck is pre-



ferred. These characteristics include a relatively small catchment area with high impervious cover. The higher the level of impervious cover, the greater the pollutant load, and the size of the required facility and the number of stakeholders can be minimized. Off-system retrofit for stormwater treatment is more difficult to implement. This approach typically requires a memorandum of understanding (MOU) with either local regulators and/or business and neighborhood interests. An MOU can be extremely time intensive to develop, substantially increasing the time for project delivery, and could result in conditions that require the DOT to deviate from standard practices.

Retrofitting a larger watershed off the highway system is a less attractive option. In general, a larger watershed will have a much higher pollutant load than the bridge itself. Consequently, the DOT may wish to share the cost of the facility as well as the maintenance requirements. Developing an agreement with other entities to accomplish an equitable cost sharing can be very challenging, particularly if there is not an immediate need for mitigation by the other stakeholders.

A final option, when constraints preclude the retrofit of a catchment within the watershed of interest, is to propose a retrofit project in another part of the highway system. This may be difficult from a regulatory perspective since pollutant trading between watersheds for stormwater NPDES compliance is not an established practice. The advantage for the DOT, of course, is that it provides the ultimate in flexibility for developing a retrofit plan.

## 5.4 Spill Controls

Spill control requirements for bridges can be viewed in the context of the probability of a spill and the risk to the receiving water. While hazardous material spills within bridge environments are of special concern due to their close proximity to receiving waters and the associated potential for severe water quality impacts, data have shown that spills have rarely occurred on or near bridges (see Section 5.4.1). Nonetheless, a single spill event could cause catastrophic environmental effects depending on the size and sensitivity of the receiving water, requiring intensive response efforts, and subsequent litigious consequences. Therefore the probability, potential risk, and impact of spills should be assessed for the bridge water body crossing to determine whether spill controls should be considered. Spill control BMPs can be implemented when deemed necessary to contain accidental spills of hazardous materials.

The following sections provide information on bridge spill frequency, costs, characteristics, and recommendations for spill control criteria and structural BMPs. Two case studies are presented where spill controls were implemented as part of the bridge design.

### 5.4.1 Bridge Spill Frequency

The U.S.DOT database (U.S.DOT 2013) on hazardous material incidents was analyzed for the period 2003–2012 to determine the frequency of spills associated with discharge to waterways. Over the 10-year period, there were approximately 140,500 reports of incidents from highways, with 97% of these incidents resulting in spillage. Incidents are classified by transportation phase which includes loading and unloading, in-transit storage (e.g., in a terminal or warehouse), and in transit. Loading or unloading accounted for a large majority (78%) of the total incidents.

For the purposes of the bridge spill frequency evaluation, only in-transit incidents resulting in spillage were evaluated. Thus, of the total reports of incidents resulting in spillage, there were 23,095 (17%) designated as “in transit.” Of these in-transit spill incidents, there were only 329 reports of spills with discharges to storm drains or waterways (less than one/year/state). Only nine spills were identified as being associated with a bridge located over a waterway. Consequently, these events are extremely rare (less than 0.01% of all reported spills for the analyzed period of record).

### 5.4.2 Bridge Spill Costs

The nine spills associated with bridges over waterways resulted in a total of approximately \$2.2 million dollars of damage including:

- \$78,000 from material loss,
- \$680,000 from carrier damage,
- \$450,000 from property damage,
- \$440,000 of response costs, and
- \$510,000 of remediation costs.

In comparison, \$116 million in damages was spent in the 10-year period for all 329 in-transit spills with discharges to storm drains or waterways. Therefore, for the 10-year period, spills associated with bridges accounted for less than 2% of these damage costs.

Overall, in-transit spills with discharges to storm drains or waterways account for 0.3% of the total damages from hazardous material spill incidents (\$761 million of damages for the 10-year period).

### 5.4.3 Bridge Spill Characteristics

The descriptions of the nine spills associated with bridges over waterways vary. Three of the spills occurred after the vehicle made impact with a bridge, while the other incidents occurred in the vicinity of a bridge and were not caused by any characteristic specific to bridge crossings. The spill descriptions



do not indicate that special characteristics of bridges are consistently the cause of the spills associated with bridge crossings. Further study is needed to better understand if bridge characteristics, in comparison to general roadway characteristics, affect the probability of spill occurrence.

#### 5.4.4 Recommended Spill Control Criteria

In general, the data on spills presented here do not support special measures to prevent damage to waterways due to bridge spills. Bridge spills represent a small percentage of the in-transit spills associated with discharges to storm drains or waterways and an even smaller subset of highway hazardous material incidents. Therefore, it is recommended that spill prevention measures be taken only when the bridge crosses a water body for which there is zero tolerance for contamination, such as a drinking water reservoir. Other water bodies of special concern for which spill prevention measures should be considered include ONRW. Examples of ONRW water bodies where even a small risk of hazardous material spill may not be tolerable include those that support high-value fisheries and wildlife habitat, and those heavily used for recreation.

#### 5.4.5 Recommended Structural Spill Control BMPs

Structural spill control BMPs for the containment of hazardous materials must be able to contain and prevent subsequent transport as their primary function. Recommended spill control storage and routing methods are discussed in this section.

##### 5.4.5.1 Spill Storage Methods

Various types of spill storage methods can be used either on the bridge or downstream of the bridge deck to contain spills. Recommended hazardous spill containment measures include but are not limited to

- Detention basins
- Capacity of bridge-incorporated storage within the superstructure (e.g., stability pontoons on floating bridges)
- Tanks and vaults
- Capacity of the collection and conveyance system (e.g., pipe storage)

Excavated detention basins that provide storage and controlled release are the most common form of hazardous spill containment measures and can be constructed near bridge abutments when adequate open space exists and conveyance from the bridge deck to this area is feasible.

In situations where the slope and hydraulic gradient are limiting or making offsite conveyance infeasible, such as for

floating bridges, storage can be incorporated into the bridge structure itself. An example of bridge-incorporated storage is provided in Section 5.4.6, Case Study 2 where supplemental pontoons have been used as temporary storage facilities that can be pumped out by responders in the event of a spill.

A variety of tanks, vaults, and conveyance storage exist for the purposes of spill containment in different sizes and materials. An advantage to these closed storage facilities, as opposed to those open to the environment like detention basins and pontoons, is that they can be placed below ground and can reduce the potential contact of spilled contaminants with the atmosphere, rainwater, or soils. A disadvantage of closed storage facilities is that they typically cost more per unit volume than detention basins and can be more expensive to maintain (e.g., may require confined space entry). Due to reduced potential for transport and dispersion of hazardous materials to the environment, closed systems are generally recommended for hazardous spill control.

##### 5.4.5.2 Spill Conveyance and Routing Methods

Spill conveyance and the method of routing the spilled material to the storage BMP are significant design considerations for successful spill containment. Routing for spill-dedicated detention basins, or other storage BMPs such as tanks or vaults, can be either in-line or off-line, where in-line represents a conveyance system with one or more storage BMPs along the stormwater flow route and off-line represents a conveyance system with an isolated storage BMP for hazardous spill containment. The isolation point for the off-line system is typically near the bridge abutment where the piped runoff containing the bridge spill material can be redirected.

In-line and off-line systems have various pros and cons. In-line systems typically require less infrastructure and design because flows do not have to be routed off the main conveyance route and isolated. However, in-line systems pose a higher risk to contamination to receiving waters if shutoff valves are not quickly closed in the event of a spill. Thus, off-line systems could potentially avoid contamination to both water and soil by containing spills separate from stormwater systems. Cleanup efforts are also likely to be less intensive and costly with off-line systems due to reduced spread and transport of hazardous materials. Due to less environmental risks and costs of spill cleanup, off-line systems are generally recommended for hazardous spill control.

#### 5.4.6 Spill Control Case Studies

The following case studies give examples of hazardous spill mitigation technologies used within bridge-specific environments.

### *Case Study 1: ODOT MAH-80 Project*

In 2009, the Ohio Department of Transportation (ODOT) completed construction of MAH-80, an extensive \$87 million project to widen and reconstruct portions of I-80 and dual 2,500-foot bridges. The bridges span Meander Creek Reservoir, which supplies drinking water to nearby towns including Youngstown and Niles. The MAH-80 project captured industry attention by including ODOT's first spill containment system, designed to prevent spills on I-80 from entering the Meander Creek Reservoir. Key components of the MAH-80 spill containment system include the following:

- A bridge profile that crests midway over the reservoir span
- A crowned bridge deck that sheds runoff to 10-12 foot shoulders sized to store and convey runoff to approach inlets without encroaching on driving lanes
- Networks of inlets, piping, and roadside ditches and swales
- Two containment basins at low points on opposite sides of the reservoir
- Two control chambers equipped with shutoff valves that prevent hazardous materials from entering the reservoir

Under typical conditions, stormwater runoff is collected and routed to basins sized to contain the 100-year event and then discharged from the basins to the Meander Creek Reservoir. In the event of a spill, the containment system allows emergency responders a maximum response time of 30 minutes to close the two shutoff valves located at each respective basin. Closing the shutoff valves allows for the spill to be contained within each basin before entering the reservoir that can then be pumped out and disposed of in accordance with local and federal regulations.

This project, which included 12.5 acres of wetland habitat creation to mitigate environmental impacts in addition to the spill containment system, was selected as the co-recipient of the 2010 Outstanding New Major Bridge Award in the 2010 Association for Bridge Construction and Design (ABCD) Northeastern Ohio Chapter's Outstanding Bridge Awards competition.

### *Case Study 2: Washington State Route 520 Bridge Replacement Study*

The WSDOT State Route 520 (SR 520) bridge replacement study developed water quality protection measures for

the replacement of SR 520 Evergreen Point Bridge, a floating bridge spanning Lake Washington. Water quality protection measures were developed using All Known, Available and Reasonable Technology (AKART) for the handling and treatment of stormwater runoff and spills affecting receiving water quality for bridge applications (CH2M HILL 2010). The AKART study resulted in identification of the following nonstructural and structural BMPs to protect receiving waters:

- High-efficiency sweeping
- Large, modified catch basins with scheduled cleaning
- Separate, enclosed spill-containment lagoons within supplemental stability pontoons

The proposed six-lane bridge, targeted to open to drivers in 2014 (U.S. DOT FHWA 2013), will use main pontoons for roadway support and additional lateral pontoons for the purpose of stability, stormwater dilution and spill containment. These lateral pontoons are deemed supplemental stability pontoons (SSPs), and the drainage system of the bridge directs all stormwater runoff to containment lagoons within the SSPs.

Once routed to the containment lagoons, floatable materials can then be pumped out by responders. Periodic removal of surface pollutants would also be part of regular maintenance. Under normal operations (when not used for containment purposes), the lagoons provide for dilution of remaining non-surface-removable pollutants and general stormwater treatment prior to discharge. Dilution of stormwater is achieved within the SSPs by providing an internal mixing zone prior to transport to the receiving waters through subsurface openings. Although dilution does not reduce the pollutant load to the receiving waters, it reduces the potential for acute toxic effects to aquatic organisms (WSDOT 2011).

The western and eastern approaches for the SR 520 Bridge include various water quality and quantity features. The western approach to the bridge includes several proposed LID improvements and spill containment features. For all improvement options, the spill containment features are consistently in the form of an underground vault. The underground vault is designed with the purpose of capturing effluent liquids from fire suppression activities and hazardous spill storage (WSDOT 2011).

## CHAPTER 6

# BMP Evaluation Tool

The BMP Evaluation Tools are a set of spreadsheets that have been provided as a supplement to this Guide that can be used for planning-level estimates of BMP treatment performance and whole life costs. The tools are Excel® applications, one for each of the various BMPs selected for bridge deck runoff treatment (Section 5.3), which allow users to input BMP design configurations and easily evaluate stormwater volume and pollutant load removal and cost implications of the BMP sizing without extensive modeling or calculations. This chapter discusses the use of the tool. One or more tools should be used to optimize BMP selection if the practitioner will be installing treatment BMPs for bridge deck runoff. To illustrate how the tool works, it will be applied to an example site in this chapter. The worked example will show how the tool can be used to quickly optimize BMP selection for the given project and assess the performance and cost of candidate BMPs.

### 6.1 BMP Evaluation Tool Overview

This section provides an overview of the functions, calculation methodology, inputs, and results and interpretations that are common to each tool.

#### 6.1.1 Tool Assessment Functions

The tool assessment functions are to provide stormwater volumes, stormwater pollutant loads and concentrations, and costs.

**Stormwater volumes.** Provide an estimate of key stormwater volumes including:

- Annual stormwater runoff volume generated by the bridge drainage area to the BMP
- Stormwater runoff volume that bypasses the BMP
- Stormwater runoff that is captured, reduced, and released as treated effluent by the BMP

- Total combined stormwater volume discharged to the receiving water body

Figure 6-1 illustrates a typical BMP and the relationship of these key stormwater volumes to the BMP.

**Stormwater pollutant loads and concentrations.** Provide an estimate of key stormwater pollutant loads and concentrations including:

- Annual stormwater runoff pollutant load generated by the bridge drainage area to the BMP
- Stormwater runoff pollutant load that bypasses the BMP
- Stormwater runoff pollutant load captured, reduced, and released as treated effluent by the BMP
- Total combined stormwater pollutant load discharged to the receiving water body
- Total annual stormwater pollutant load reduction
- Annual influent, treated, and combined effluent concentrations

**Costs.** Provide an estimate of whole life costs including:

- Direct and associated capital costs of designing and installing the BMP
- Regular and corrective maintenance costs of the BMP
- Annualized whole life costs per annual load removed

#### 6.1.2 Tool Calculation Methodology

Four primary calculations provide the estimations required to serve the tool volume, pollutant and cost assessment functions including: (1) annual stormwater runoff volume to the BMP, (2) amount of runoff captured and reduced by the BMP, (3) BMP influent and effluent pollutant loading, and (4) BMP material quantities. Summarized information regarding these four calculations is provided in the following sections. Detailed information for volume and pollutant load

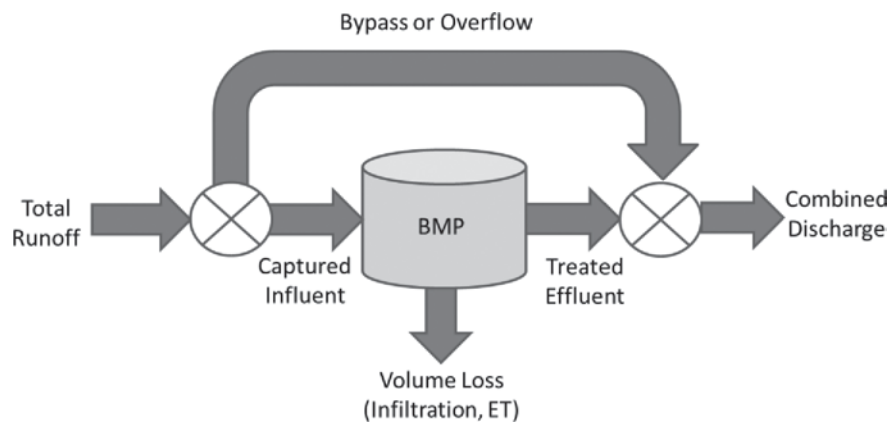

**Figure 6-1. General BMP stormwater volumes schematic.**

modeling methods can be found in Appendix E: BMP Evaluation Tool Modeling Methodology.

#### 6.1.2.1 Average Annual Runoff Volume

Average annual runoff volume to the BMP in the tool is based on the average annual rainfall depth, a computed volumetric runoff coefficient, and the tributary drainage area. A volumetric runoff coefficient equation that is a function of imperviousness is used to estimate the fraction of annual rainfall that becomes runoff. The general form of the volumetric runoff coefficient equation is based on Granato (2006). The computed volumetric runoff coefficient is then used as the basis for estimating the average annual runoff volume from a particular drainage area. Detailed information on the average annual runoff volume modeling can be found in Appendix E: BMP Evaluation Tool Modeling Methodology.

#### 6.1.2.2 BMP Volume Capture and Loss

The amount of runoff captured by the BMP in the tool was estimated using the EPA Storm Water Management Model (SWMM) Version 5.0.022 continuous simulation model. An array of unit-area hydrologic models was developed to represent various climatic regions for the contiguous United States, soil types, and imperviousness. The models were used to evaluate the hydrologic and hydraulic performance of the BMP types selected for bridge deck runoff treatment. Normalized performance curves were developed for estimating the percentage of the annual runoff volume captured by a site-specific BMP type, configuration, and outflow rates (infiltration, ET, and controlled release). The tool interpolates between the results of continuous simulation runs within the range of the BMP design parameters to produce an estimate of average annual capture efficiency and percent volume loss. An advantage to continuous simulation modeling for the BMP volume

capture analysis was the ability to account for the variability in the frequency and magnitude of storm events at a particular climatic region/sub-region in relation to a given BMP design.

#### 6.1.3 Pollutant Loading

The pollutants of concern selected for the tool calculations were based on the types of pollutants commonly monitored and observed in highway runoff and identified in NPDES permits and other regulatory requirements. Pollutant load calculations in the Tool were completed using different methods for inflows to the BMP and treated effluent from the BMP.

To provide representative bridge stormwater runoff quality inflows for BMP treatment analysis, highway runoff mean concentrations developed through statistical analyses of all sites within the Highway Runoff Database (HRDB) (Smith and Granato 2010) and highway land use sites in the National Stormwater Quality Database (NSQD) (Pitt 2008) were used. These mean concentrations were multiplied by the estimated annual runoff volume to estimate the total load to the BMP. The annual bypass load is similarly estimated by using the runoff volume minus the captured volume.

For tool effluent loading, the expected BMP load removal was calculated using BMP performance curves developed from a regression of influent versus effluent mean concentrations from the International Stormwater Best Management Practice Database (BMPDB). The default highway runoff influent concentrations were used as input for the calculated BMPDB influent/effluent relationship. The estimated effluent concentrations are multiplied by the estimated discharge volume to predict the average annual load discharging from the BMP. The total load is finally computed as the sum of the discharged load and the bypassed load. Detailed information on the pollutant loading analysis methodology used in the calculations can be found in Appendix E: BMP Evaluation Tool Modeling Methodology.



### 6.1.3.1 Material Quantities

Material quantities calculations in the tool were based on the BMP configurations with typical default assumption for design values such as side slopes and length-to-width ratio to estimate excavation volumes, BMP component lengths and volumes, and grading and restoration areas for capital cost calculations. As discussed in Appendix B: Simple and Complex Assessment Methods and Worked Example, many user inputs are customizable to represent desired BMP design configurations for optimized assessment of performance and costs.

### 6.1.4 Tool Inputs

The tool inputs include user-specific climate data based on closest available rain gage, bridge deck tributary area characteristics, and the treatment BMP design features/configuration. Rain gages are selected based on groupings of the National Climatic Data Center (NCDC) climate divisions (Figure 6-2) to provide a list of gages in a specific region. User-friendly features of the Tools include a navigation bar to navigate to key input forms via a one-button click, a color-coded key to identify cell content application (i.e., instructions, headings, user data, and reference data), drop-down menus for select

inputs, and built-in guidance information located directly adjacent to design values for ease of customization.

Default values for climate and BMP design parameters are provided for ease of use. Appendix B: Simple and Complex Assessment Methods and Worked Example, discusses how most defaults are customizable by the user to adapt to site-specific needs. Appendix E: BMP Evaluation Tool Modeling Methodology provides detailed information on Tool organization, project set up, entering project data, and general information such as saving, editing, and printing multiple scenarios.

### 6.1.5 Tool Results and Interpretations

The tool results are presented in a single worksheet and include the following:

- Summary of the modeled scenario (tributary area, BMP type, rain gage location, and precipitation depth)
- Summary of design parameters (BMP type and configuration data)
- Summary of whole life costs (capital and maintenance costs as well as WLC per load removed). Note, whole life costs presented in the BMP Evaluation Tool do not account for the cost associated with drainage conveyance systems

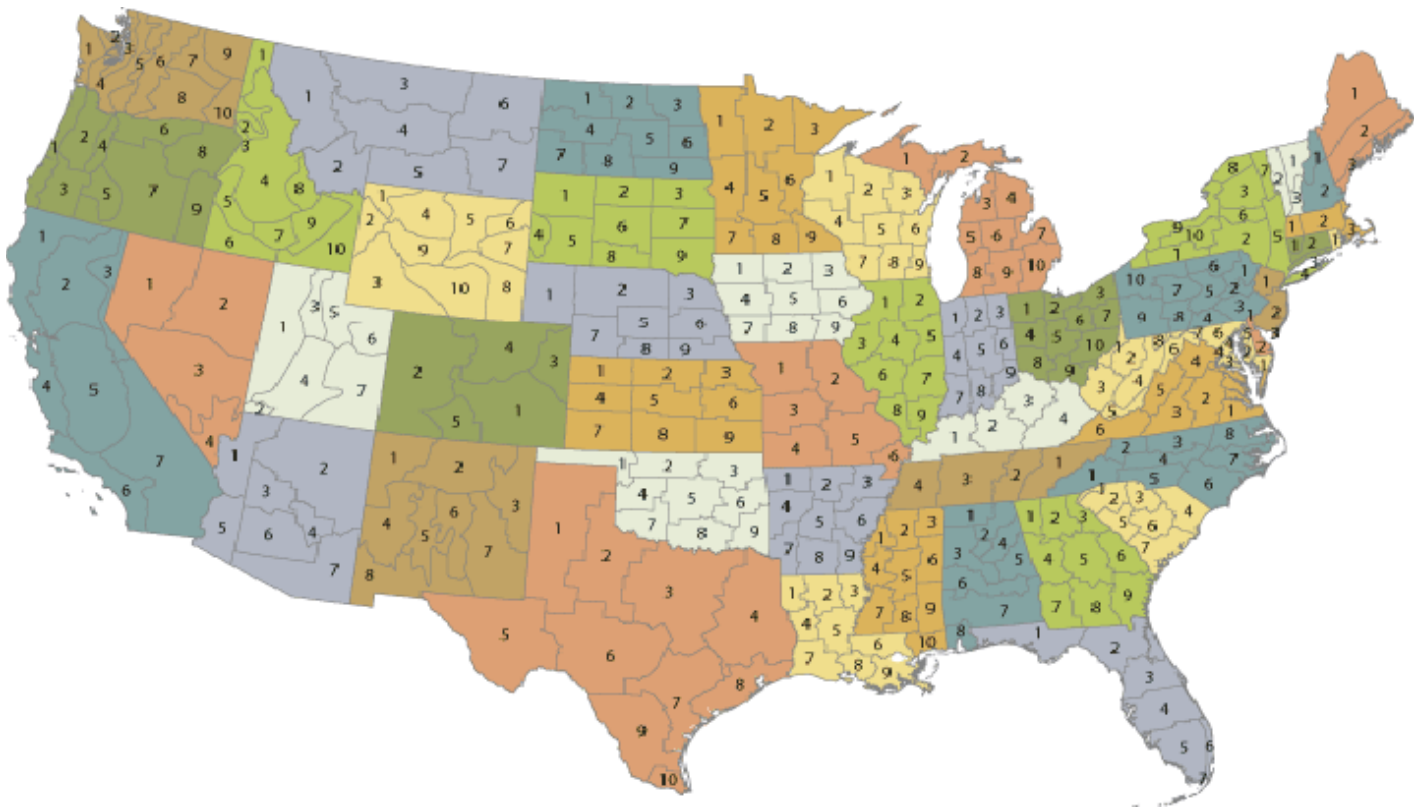

Figure 6-2. NCDC climate division groupings for tool rain gage selection.



within the deck of the bridge. That cost can be estimated separately by using a stand-alone deck drain cost tool created as part of this work effort. Details associated with use and interpretation of the deck drain cost tool are discussed in Appendix D.

- Tabular and graphical summary of volume performance (see Appendix B: Simple and Complex Assessment Methods and Worked Example)
- Tabular and graphical summary of pollutant load performance (see Appendix B: Simple and Complex Assessment Methods and Worked Example)
- Tabular summary of water quality concentrations (see Appendix B: Simple and Complex Assessment Methods and Worked Example)

Appendix D: User's Guide for the BMP Evaluation Tool provides detailed information on viewing and interpreting results.

#### 6.1.5.1 Volume Performance Results

The following volume performance results are provided by the tool:

- Baseline average annual runoff volume: the total volume of annual runoff for the site (bridge deck) based on climatic region/sub-region, drainage area, imperviousness, and soil type.
- BMP captured volume: the volume of annual runoff captured by the BMP.
- BMP effluent volume: the volume of annual runoff that is treated and released from the BMP through controls such as underdrains, orifices, weirs, etc.
- Runoff bypassed (overflow) volume: the volume of annual runoff not captured by the treatment BMP that bypasses or overflows directly to the receiving water body. Note that the tool conservatively assumes that overflow receives no treatment even though some limited treatment of this volume may occur.
- Total discharge volume: the volume of annual runoff discharged to the receiving water body. This is calculated by adding the bypassed and effluent volumes.
- Total volume reduction: the volume of annual runoff lost by the BMP through infiltration and ET.

#### 6.1.5.2 Pollutant Load Performance Results

The following pollutant load performance results are provided by the tool:

- Baseline average annual runoff load: the total annual pollutant load for the site (bridge deck). This is calculated by

multiplying total annual runoff volume by the characteristic highway runoff mean concentration.

- BMP captured load: the annual pollutant load captured by the treatment BMP. This is calculated as the difference between the baseline average annual runoff load and the bypassed load.
- BMP effluent load: the annual pollutant load from the BMP to the receiving water body. This is calculated by multiplying the BMP effluent volume by the treatment BMP pollutant mean effluent concentration (computed based on influent-effluent concentration relationship).
- BMP load reduction: the total annual pollutant load removed by the BMP. This is calculated by subtracting the BMP effluent load from the BMP captured load.
- Bypassed load: the annual pollutant load not captured by the treatment BMP and discharged directly to the receiving water body. This is calculated by multiplying the BMP bypassed volume by the characteristic highway runoff mean concentration.
- Percent annual BMP load removal: the percentage of annual pollutant load removed by the BMP. This is calculated by dividing the total BMP load reduction by the baseline average annual runoff load.
- Total discharge load: the total annual pollutant load to the receiving water body. This is calculated by adding the bypassed load to the BMP effluent load.
- Total volume reduction load: the annual pollutant load removed via infiltration and ET. This is calculated by multiplying the baseline average annual runoff load by the percentage of total annual volume lost.
- Treatment reduction load: the annual pollutant load removed by the BMP by non-volume loss treatment processes that reduce concentrations including adsorption, filtration, settling, decomposition and plant uptake. This is calculated by subtracting both the total volume reduction load and the BMP effluent load from the BMP captured load.

#### 6.1.5.3 Water Quality Concentrations

The tool provides the following water quality concentrations:

- Influent concentration: the pollutant concentration in the BMP influent, given as default highway runoff concentrations unless modified by the user.
- Treated effluent concentration: the pollutant concentration in the BMP effluent calculated using influent/effluent performance curves.
- Whole effluent concentration: the pollutant concentration for the total discharge to the receiving water body, calculated by dividing the total discharge load by the total discharge volume.

The data and methods used to calculate these concentrations are provided in Appendix E: BMP Evaluation Tool Modeling Methodology.

### 6.1.6 Tool Supporting Data

The tool provides underlying supporting data used to produce the hydrologic and water quality estimates. For example, nomographs that summarize the long-term continuous simulation model results specific to the user-selected rain gage are provided. These nomographs could be used outside of the tool for additional BMP sizing and assessment purposes. Appendix E: BMP Evaluation Tool Modeling Methodology provides information on viewing supporting data.

## 6.2 Worked Example of Tool

This section provides a worked example of the Bioretention tool, using the Marquam Bridge in Portland, Oregon, as an example. The purpose of this example is to demonstrate the tool input requirements. A comprehensive worked example, using the BMP assessment procedure outlined in this guide, is provided in Appendix D.

The Marquam Bridge is a double-deck, steel truss cantilever bridge across the Willamette River that was designed by the Oregon Department of Transportation (ODOT) and was open to traffic in 1966. Figure 6-3 is a picture of the bridge under construction in 1964.

### 6.2.1 Project Locations and Climate Selection

The project information was first entered into the tool on the first worksheet as shown in Figure 6-4. For this worked example, a portion of the I-5 eastbound entrance ramp and bridge deck of the Marquam Bridge was routed to a bioretention basin adjacent to the entrance ramp for treatment (Figure 6-5).

The Portland International Airport rain gage was selected for this project, which has an 85th percentile, 24-hr storm



Figure 6-3. Marquam Bridge under construction in 1964.

depth of approximately 0.63 inches and 36.7 inches of average annual precipitation (Figure 6-6).

### 6.2.2 Project Options

In the “Project Options” worksheet, under “Pollutant Loads,” highway runoff concentrations were left at their default values. For “Cost Inputs,” the only change that was made for this project was to change the “Local Sales Tax” value to zero because the state of Oregon does not have sales tax. No edits were made to capital or maintenance cost inputs (Figure 6-7).

### 6.2.3 Project Design

In the project design worksheet, the following information for the project was used:

- Tributary Area = 32 ft wide × 2,050 ft long = 65,600 ft<sup>2</sup> = 1.5 ac
- Impervious Area = 100%

NCHRP Bioretention Evaluation Tool			
Project Title	Marquam Bridge I-5 Eastbound Partial Entrance Ramp and Bridge Deck		
Project Location	Portland, OR		
Company	ABC Company		
PROJECT LOCATION AND CLIMATE SELECTION	PROJECT OPTIONS	TRIBUTARY AREA ATTRIBUTES	BMP
Location and Climate Attributes			
Step 1: Select the Region your Project is Located			

Figure 6-4. Entering project information into the tool.



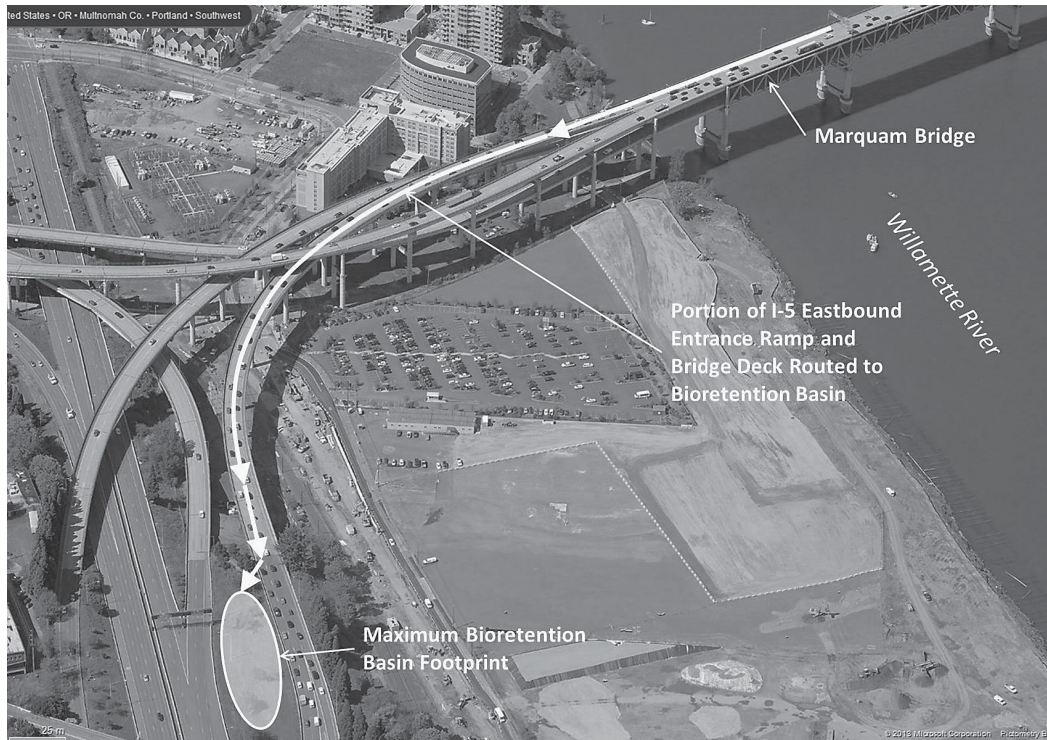

**Figure 6-5. Marquam Bridge drainage routing for worked example.**

- Maximum Bioretention Basin Footprint = 80 ft x 360 ft = 28,800 ft<sup>2</sup>
- Soil Type (Hydrologic Soil Group) for Bioretention Basin area = Sandy Clay Loam (C); assumption based on NCRS Web Soil Service data indicating soils as “50A-urban land, 0 to 3% slopes”

Because it was assumed that the soils underlying the bioretention basin were C soils, an underdrain was used for this bioretention design. Additionally, because footprint area was available for the bioretention basin, a shallower

ponding depth was chosen and a higher length-to-width ratio of the basin was chosen to fit with the linear nature of the basin area. It was desired that a minimum 6-inch underdrain would be fully embedded in the stone reservoir layer. Based on these design considerations, the following changes were made to the default design parameter information in the tool:

- Ponding depth = 0.5 feet
- Stone reservoir thickness = 1.5 feet
- BMP length/width ratio = 4

Step 2: Select the State your project is located and the rain gage closest to the project	
States within Selected Region	Rain Gages Available in State
Oregon	[2] WILLAMETTE VALLEY - PORTLAND INTL AP
COOP ID	356751
Elevation, feet	19
85th Percentile, 24-Hour Storm Depth, inches	0.63
95th Percentile, 24-Hour Storm Depth, inches	0.98
Average Annual Precipitation Depth, inches	36.7
Step 3: If available, override the existing data and provide project specific rain data	
Project Location 85th Percentile, 24-Hour Storm Depth (in)	0.63
Project Location Average Annual Precipitation Depth (in)	36.7

**Figure 6-6. Entering rain gage information into the tool.**

Project Options	
<b>Key</b>	
User Steps	Default Data (editable)
Headings and Descriptions	Guidance
User Entered Data	
Step 1: View/Edit Highway Runoff Concentrations	
<b>Pollutant Loads</b>	
Would you like to view/edit the highway runoff concentrations for the project?	no
Step 2: Select Primary Cost Inputs	
<b>Cost Inputs</b>	<b>Value</b>
Location Adjustment Factor (100 = nationwide average)	100
Expected Level of Maintenance (H = High, M = Medium, L = Low)	M
Discount Rate (%)	5
Inflation Rate for labor and materials (%)	3
Local Sales Tax (%)	0
Would you like to view/edit the capital cost inputs?	no
Would you like to view/edit the maintenance cost inputs?	no

Figure 6-7. Entering project options into the tool.

The storage volume sizing for the bioretention basins was designed to meet the City of Portland’s stormwater regulations of 90% average annual runoff volume capture. To accomplish this, the Goal Seek function under Data → What-If Analysis → Goal Seek was used. In the Results Summary Report worksheet, cell C45 (Percent of Baseline Runoff Volume, % for BMP Captured) was selected set to a value of 0.9 (for 90%—this was entered as 0.901 for this example to ensure the full capture volume) in the Goal Seek function by changing cell B31 (Storage Volume) in the “Project Design” worksheet. For the assumptions indicated above, the storage volume required was 2,081 cubic feet, which resulted in a total footprint of

1,610 square feet (approximately 6% of the maximum available footprint area). Figure 6-8 and Figure 6-9 show the primary and additional design parameters.

### 6.2.4 Results

The following sample results were taken from the “Results Summary Report”

#### Volumes

Figure 6-10 shows the following volume results:

Primary Bioretention Design Parameters	Value
Storage Volume (cu-ft)	2,070
Underlying Soil Design Infiltration Rate (in/hr)	0.2
Underdrain Present?	yes
Ponding Depth (ft)	0.5

Figure 6-8. Entering primary bioretention design parameters into the tool.

**Additional Bioretention Design and Reference Parameters**

Planting Media Thickness (ft)	2
Stone Reservoir Thickness (ft)	1.5
Underdrain Discharge Elev. from bottom of stone reservoir (ft)	0.5
Planting Media Filtration Rate (in/hr)	2
Soil Freely Drained Storage (in/in)	0.2
Soil Suction Storage (in/in)	0.15
Crop coefficient of Vegetation	0.7
Stone Freely Drained Storage (in/in)	0.4
BMP Length/width ratio (L:W)	4
Mulch depth above Planting Media Layer (ft)	0.25
Mulch porosity (in/in)	0.5
Pea Gravel Depth within Stone Reservoir (ft)	0.25
Freeboard depth (ft)	1
Horizontal/vertical side slope ratio (H:1V)	3
Approximate Total Footprint to Top of Freeboard, sq-ft	1,610
Calculated Drawdown Time of Surface Ponding, hours	3

**Figure 6-9. Entering additional bioretention design parameters into the tool.**

**Percentage of Annual Runoff Volume Discharged and Removed**

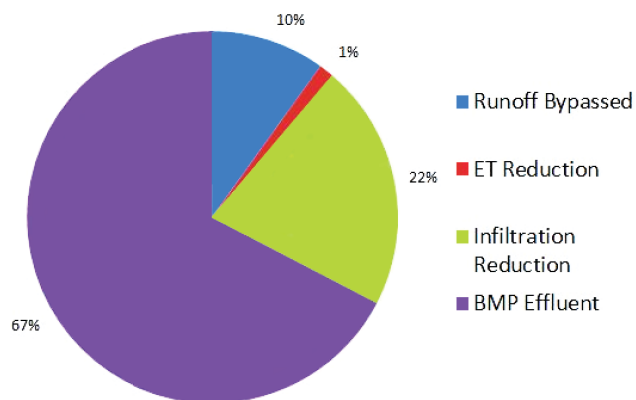

**Figure 6-10. Volume results from tool.**

- Total volume reduction = 23% (ET plus infiltration)
- Runoff bypassed = 10% (BMP captured= 90%)
- BMP effluent = 67%

**Pollutant Loads and Concentrations**

- Copper: annual load reduction = 65%; total discharge = 0.141 lbs/yr; cost per lb removed = \$13,657; treated effluent concentration = 15.7 µg/L
- TP: annual load reduction = 23%; total discharge = 3.28 lbs/yr; cost per lb removed = \$3,676; treated effluent concentration = 0.44 mg/L
- TSS: annual load reduction = 82%; total discharge = 241 lbs/yr; cost per lb removed = \$3.26; treated effluent concentration = 16.91 mg/L

**Whole Life Costs**

Costs are summarized in Figure 6-11.



### Summary of Whole Lifecycle Cost Results

Capital Costing Method	Line Item Engineer's Estimate
Assumed Level of Maintenance	M
Estimated Capital Cost, \$ (2013)	\$27,694
Estimated NPV of 50-year Maintenance Costs, \$ (2013)	\$74,052
Estimated NPV of 50-year Whole Life Cycle Cost, \$ (2013)	\$101,745
Estimated Annualized Whole Life Cycle Cost, \$/yr (2013)	\$2,035

Costs are based on assumed service life of 50 years with routine and major maintenance.

**Figure 6-11. Whole life cost results from tool.**

## 6.3 Tool Customization

The tool has been designed to be customizable to allow for overwriting of much of the default data so users can use the best available project information for their sites. It is recognized that customization will allow for each DOT to input information based on localized rainfall statistics and water quality data, as well as BMP construction and maintenance specifications, practices, and costs.

Default data that is user editable includes precipitation information (85th percentile storm event depth and annual average rainfall depth), pollutant concentrations, BMP design parameters, and cost inputs. It is recommended that, for design purposes, local precipitation gage and site-specific information be used to increase the accuracy of volume and pollutant loading results. Editable cost inputs include the following:

- Location adjustment factor for unit costs
- Expected level of maintenance
- Design life (the expected lifespan in years)
- Discount rate
- Inflation rate
- Percent local sales tax
- Capital cost quantities and unit costs, including the addition of a bridge deck conveyance system capital cost from the separate conveyance system spreadsheet
- Maintenance frequency, hours, labor crew size, labor rates, machinery rates, and incidental costs

## 6.4 Tool Intended Uses

The tool treatment performance results together with the whole life cost estimates are intended to provide DOTs with planning level information useful for evaluating receiving

water protection benefits and the magnitude of costs associated with BMP installation efforts. This type of feedback can have a number of potential applications in BMP selection and design for various direct and indirect uses that are described in the following sections.

### 6.4.1 Direct Tool Uses

**Evaluate volume and pollutant load reduction in comparison to baseline conditions and/or performance targets/standards.** The tool can be used to estimate the volume and pollutant load reduction (i.e., percent reduction of runoff volume and loads compared to the baseline condition without controls) for a wide range of potential BMP configurations. The results from the tool can also be compared directly to project goals or regulatory requirements such as TMDL implementation plans or volume reduction goals. Design parameters can be adjusted in the Tool to improve BMP performance and meet project goals.

**Quickly compare several BMPs for a given drainage area.** Once project location and tributary area have been established, the tools can be used to evaluate different BMP types, configurations, performance, and costs to provide an understanding of the varying sizing and pollutant removal capabilities of the BMP types and to aid in choosing the most appropriate, cost-effective BMP for a given site.

**Evaluate performance relationships and sensitivities of design parameters.** The tool provides the ability to adjust design parameters and obtain near-immediate estimates of long-term performance (i.e., without requiring delay required to setup and run a continuous simulation model). This functionality can be used to evaluate performance relationships and sensitivities as well as understand how changing design parameters affect project costs. For example, the water quality

benefits of increasing BMP sizing to provide 90% average annual runoff capture instead of 80% can be compared alongside the BMP costs to assess if there is a proportional benefit to increasing the average annual runoff capture. Additionally, BMP sizing can be adjusted to assess the volume and pollutants being captured and treated by the BMP versus the volume and pollutants that bypass or overflow the BMP.

#### 6.4.2 Indirect Tool Uses

**Aid in development of stormwater programs.** The tool can be used to identify and establish needs and resources as part of DOT stormwater program development including, for example, BMP land requirements, BMP costs per drainage area to meet local regulatory requirements, and maintenance requirements and costs. The ability to customize input in the tool allows for easy year-to-year changes such as inflation and tax increases.

**Quantify local precipitation statistics.** The tool contains the results of an analysis of 347 precipitation gages across the conterminous United States. Key precipitation statistics,

including the 85th percentile and 95th percentile, 24-hour precipitations depths and average annual precipitation depths are provided after the user selects the gage that best represents the project. These statistics can be useful as part of design development.

**Establish planning-level sizing targets.** At the start of the planning process it may be useful to hold certain parameters fixed and simply vary storage volume or footprint over a representative range to develop general relationships between BMP size and the expected performance. This can help identify how much space may be needed within a site to achieve a certain goal and provide early feedback on what goals are reasonable. The percent capture nomographs can be used to evaluate the BMP sizing impacts of a higher annualized capture volume.

**Evaluate potential regional variability in performance associated with a given design standard.** By holding all other parameters fixed and changing the project location attributes, the user can quickly determine how much variability would be expected in performance as a function of project location if a uniform design standard were to be adopted across an entire jurisdiction (e.g., a single design storm depth across a state).

# References

- ADOT (2009). *Post Construction Best Management Practices Manual: For Highway Design and Construction*. Arizona Department of Transportation.
- ADOT (n.d.). Project interview with Mark Maurer, PLA, PE, Highway Runoff Program Manager.
- Allen, J. S. (2001). *Sampling and Testing of Stormwater Runoff from North Carolina Highway*.
- Bannerman, S. (2007). *Evaluation of Street Sweeping as a Stormwater-Quality-Management Tool in Three Residential Basins in Madison, Wisconsin*, USGS Scientific Investigations Report 2007–5156.
- Barbaro, A. M. (2012). Project interview with Alex Murray and Henry Barbaro, Massachusetts DOT, December.
- Barrett, M. (2010). *Evaluation of Sandfilter Performance*, CRWR Online report, 10-07. Center for Research in Water Resources, Bureau of Engineering Research, The University of Texas at Austin.
- Barrett, M., et al. (2014). *NCHRP Report 767: Measuring and Removing Dissolved Metals from Stormwater in Highly Urbanized Areas*, Transportation Research Board of the National Academies, Washington, DC.
- Barrett, M. E., Kearfott, P., and Malina, J. F. (2006). Stormwater Quality Benefits of a Porous Friction Course and Its Effect on Pollutant Removal by Roadside Shoulders. *Water Environment Research*, 76(11): 2175-2185.
- Bartelt-Hunt, S. et al. (2012). *Evaluation of the Environmental Impacts of Bridge Deck Runoff*, Nebraska Transportation Center, University of Nebraska, Lincoln.
- Berbee, R., Rijs, G., de Brouwer, R., and van Velzen, L. (1999). Characterization and Treatment of Runoff from Highways in the Netherlands Paved with Impervious and Pervious Asphalt. *Water Environ. Res.*, 71 (2): 183–190.
- Bishop, J. M. (2003). *Review of International Research Literature Regarding the Effectiveness of Auditory Bird Scaring Techniques and Potential Alternatives*. Department for Environment Food and Rural Affairs. Retrieved from <http://www.defra.gov.uk/environment/quality/noise/research/birdscaring/>
- Bluestein, H. (2009). The Formation and Early Evolution of the Greensburg, Kansas, Tornadoic Supercell on 4 May 2007. *Weather and Forecasting*, 24: 899-920.
- Brunner, G. W. (2010). *HEC RAS River Analysis System Hydraulic Reference Manual*. Davis, CA: US Army Corps of Engineers Hydrologic Engineering Center.
- Caltrans (2004). *BMP Retrofit Pilot Program Final Report*, CTSW-RT 01-050.
- Caltrans (2004). *Caltrans Snow and Ice Control Operations*. [www.dot.ca.gov/hq/roadinfo/snvicecontrol.pdf](http://www.dot.ca.gov/hq/roadinfo/snvicecontrol.pdf), cited in Venner/AASHTO, 2004. Retrieved from <http://www.dot.ca.gov/hq/roadinfo/snvicecontrol.pdf>
- Caltrans (2004a). *The Use of Deicing Chemicals on California State Highways*. Caltrans Report to the Legislature in response to Chapter 318. (July, 1992), cited in Venner/AASHTO, 2004.
- Caltrans (2009). *Stormwater Quality Handbook Maintenance Staff Guide* CTSW-RT-02-057. California Department of Transportation.
- Caltrans. (2004). *BMP Retrofit Pilot Program, Final Report*. Sacramento. Cambridge Systematics, Inc., et al. (2011). *NCHRP Report 688: Determining Highway Maintenance Costs*. Transportation Research Board of the National Academies, Washington, D.C. Retrieved from [http://onlinepubs.trb.org/onlinepubs/nchrp/nchrp\\_rpt\\_688.pdf](http://onlinepubs.trb.org/onlinepubs/nchrp/nchrp_rpt_688.pdf)
- Center for Watershed Protection (2007). *Urban Subwatershed Restoration Manual No. 3, Urban Stormwater Retrofit Practices Version 1.0*.
- CH2M HILL (2010). *AKART and Water Quality Studies for SR 520 Replacement Floating Bridge*. Prepared for Washington State Department of Transportation and the Federal Highway Administration.
- Connolly, S. (2012). Project interview with Sean Connolly, January 9, 2012.
- Connolly, S. (2013). Project interview with Sean Connolly, South Carolina Department of Transportation, January 2013.
- Cooley, Jr., L. A., et al. (2009). *NCHRP Report 640: Construction and Maintenance Practices for Permeable Friction Courses*. Transportation Research Board of the National Academies, Washington, DC.
- Copas, T. L. and Pennock, H. A. (1979). *NCHRP Synthesis of Highway Practice 67: Bridge Drainage Systems*. TRB, National Research Council, Washington, D.C.
- CTC and Associates (2009). *Lead Based Bridge Paint Sampling and Disposal: A Survey of State Practice*. Transportation Synthesis Report, Wisconsin Dept. of Transportation.
- Currier, B., Taylor, S., et al. (2001). California Department of Transportation BMP Retrofit Pilot Program, presented at Transportation Research Board 8th Annual Meeting, Washington, D.C.
- CWP. (n.d.). *Article 121: Technical Note 103 from Watershed Protection Techniques 3(1)*. Center for Watershed Protection, 601-604
- Davis, A. P. (2003). Water Quality Improvement through Bioretention: Lead, Copper, and Zinc Removal. *Water Environmental Resource*, 75(1):73-82.
- Davis, A. P. (2008). Field Performance of Bioretention: Hydrology Impacts. *Journal of Hydrologic Engineering*, 90-95.

- Dupuis, et al. (1985). *Effects of Highway Runoff on Receiving Waters Volume III, Resource Document for Environmental Assessments*. Report No. RD-84/064, FHWA, Office of Research and Development.
- Dupuis, T. (2002) *NCHRP Report 474: Assessing the Impacts of Bridge Deck Runoff Contaminants in Receiving Waters: Volume 1, Final Report and Volume 2, Practitioner's Handbook*. TRB, National Research Council, Washington, DC.
- Eck, B. et al. (2012). Water Quality of Drainage from Permeable Friction Course, *Journal of Environmental Engineering*, ASCE, 174.
- Eck, B., Klenzendorf, J., Charbeneau, R., and Barrett, M. (2010). *Investigation of Stormwater Quality Improvements Utilizing Permeable Friction Course (PFC)*. Retrieved from [http://www.utexas.edu/research/ctr/pdf\\_reports/0\\_5220\\_2.pdf](http://www.utexas.edu/research/ctr/pdf_reports/0_5220_2.pdf)
- EOA and Geosyntec (2011). *Sediment Management Practices: Clean Watershed for a Clean Bay Task 4 Literature Review*. Prepared for the Bay Area Stormwater Management Agencies Association.
- FHWA (1993). *Design of Bridge Deck Drainage*, Hydraulic Engineering Circular No. 21, Washington, DC.
- FHWA (2012). *Creating an Effective Program to Advance Transportation System Management and Operations: A Primer*, FHWA Report Number: FHWA-HOP-12-003. U.S. Department of Transportation. Retrieved from <http://www.ops.fhwa.dot.gov/publications/fhwahop12003/background.htm#basic>
- FHWA (2013). *Building a Safer, More Reliable Bridge and Roadway while avoiding Environmental Justice Impacts*. Office of Planning, Environment & Reality. Retrieved March 20, 2013, from [http://www.fhwa.dot.gov/environment/environmental\\_justice/e](http://www.fhwa.dot.gov/environment/environmental_justice/e)
- Fleming, G. (2012). [http://meanderwater.com/Portals/MeanderWater/Documents/ODOT%20MAH-80%20in%20HPCD%2002-26-09%20\(2\).pdf](http://meanderwater.com/Portals/MeanderWater/Documents/ODOT%20MAH-80%20in%20HPCD%2002-26-09%20(2).pdf).
- Foster, A. (2012). Personal communication with Amy Foster, TxDOT, December 2012.
- Geosyntec Consultants and Wright Water Engineers, Inc. (2011). *International Stormwater Best Management Practices (BMP) Database - Technical Summary: Volume Reduction*.
- Geosyntec Consultants, et al. (2009). NCHRP Project 25-31, "Guidelines for Evaluating and Selecting Modifications to Existing Roadway Drainage Infrastructure to Improve Water Quality in Ultra-Urban Areas Interim Report." Washington D.C.: National Cooperative Highway Research Program.
- German, J. (2002). Metal Content and Particle Size Distribution of Street Sediments and Street Sweeping Waste, *Water Science and Technology*, 46 (6-7): 191-198.
- Gorenzel, W. and Salmon, T. P. (1982). The Cliff Swallow—Biology and Control. *Proceedings from the Tenth Vertebrate Pest Conference*, University of Nebraska, Lincoln, NE, 179-185.
- Granato, G. E. (2006). Kendall-Theil Robust Line (KTRLine—version 1.0)—A Visual Basic Program for Calculating and Graphing Robust Nonparametric Estimates of Linear-Regression Coefficients Between Two Continuous Variables. *Techniques and Methods of the U.S. Geological Survey*, Book 4, Chap. A7.
- Haag-Wackernagel, D. and Geigenfeind, I. (2008). Protecting Buildings Against Feral Pigeons. *European Journal of Wildlife Research*, 54: 715–721.
- Haag-Wackernagel, D. and Moch, H. (2004). Health Hazards Posed by Feral Pigeons. *Journal of Infection*, 48(4): 307-313.
- Harris, J. (2013). Project interview with Joubert Harris, LADOTD, January 3, 2013.
- Harrison, R. M., and Wilson, S. J. (1985). The Chemical Composition of Highway Drainage Waters I: Major Ions and Selected Trace Metals. *Science of the Total Environment*, 43: 63-77.
- Hunt, W., and Lord, B. (2006). *Maintenance of Stormwater Wetlands and Wet Ponds*. North Carolina Cooperative Extension Service.
- Irvine, K. P.-k. (2009). Metal levels in Street Sediment from an Industrial City: Spatial Trends, Chemical Fractionation, and Management Implications, *J. Soils Sediments*, (9): 328-341.
- Johnston, R. F. (1992). Rock Pigeon (*Columba livia*). *The Birds of North America Online*, A. Poole, ed. Cornell Lab of Ornithology, Ithaca, NY. Retrieved from the Birds of North America Online: <http://bna.birds.cornell.edu/bna/species/013>.
- Kane, R. C. (1987). Precipitation Characteristics of Mesoscale Convective Weather Systems. *J. Climate Appl. Meteor.* 26, 1345-1357.
- Kang, J. D. (2009). Storm-Water Management Using Street Sweeping, *ASCE Journal of Environmental Engineering*, 135 (7): 479-489.
- Keeley, B. W. and Tuttle, M. D. (1999). *Bats in American Bridges*. Bat Conservation International, Inc., Resource Publication No. 4, Austin, TX.
- Kern, W. (1995). Bat Exclusion Methods. *Seventh Eastern Wildlife Damage Management Conference*, 139-148.
- King, E. S. (2006). Memo to the Water Management Division Directors, Regions 1-10, USEPA, August 8, 2005. Washington, DC. Retrieved from <http://www.epa.gov/waterscience/standards/files/tier2.pdf>
- Kogler, R. (2012). *FHWA-IF-12-052 - Vol. 19 Steel Bridge Design Handbook: Corrosion Protection of Steel Bridges*. Washington, D.C.: U.S. Department of Transportation Federal Highway Administration.
- Kurahashi & Associates, Inc. (1997). *Port of Seattle, Stormwater Treatment BMP Evaluation*.
- Lagasse, P. F., Clopper, P. E., Pagan-Ortiz, J. E., Zevenbergen, L. W., Arneson, L. A., Schall, J. D., and Girard, L. G. (1997). *Bridge Scour and Stream Instability Counter Measures Experience Selection and Design Guidance HEC 23*. Arlington, VA: U.S. Department of Transportation Federal Highway Authority. Retrieved from HEC 23 Bridge Scour and Stream Instability Counter Measures: <http://www.fhwa.dot.gov/engineering/hydraulics/pubs/09111/>
- Lampe, Barrett, et al. (2005). *Performance and Whole Life Costs of Best Management Practices and Sustainable Urban Drainage System*. Project 01-CTS-21Ta. Alexandria, VA: Water Environment Research Foundation.
- Lauffer, M. H. (2012). Project interview with Matt Lauffer and Kathy Herring, NCDOT, and Michelle Mayfield, Alex Nice (URS Corp), and Chad Wagner, USGS, December 20, 2012.
- Law, N. et al. (2008). *Deriving Reliable Pollutant Removal Rates for Municipal Street Sweeping and Storm Drain Cleanout Programs in the Chesapeake Bay Basin*. Center for Watershed Protection.
- Li, H., and Davis, A. P. (2008). Heavy Metal Capture and Accumulation in Bioretention Media. *Environmental Science and Technology*, 5247-5253.
- Malina, J. et al. (2005). *Characterization of Stormwater Runoff from a Bridge Deck and Approach Highway, Effects on Receiving Water Quality*, Center for Transportation Research, University of Texas at Austin.
- Mattejat, P., and Thompson, B. (2007). P-23 - Development of Delaware Department of Transportation Stormwater Best Management Practice Inspection Program. Retrieved from [http://www.deldot.gov/stormwater/pdfs/P23\\_DelDOT-BMP-Inspection.pdf](http://www.deldot.gov/stormwater/pdfs/P23_DelDOT-BMP-Inspection.pdf)
- Maurer, M. (2012). Project interview with Mark Maurer, PLA, PE, Highway Runoff Program Manager, Washington State Department of Transportation, December 18, 2012.
- McDaniel, R. S., K. J. Kowalski, A. Shah, J. Olek, and R. J. Bernhard (2010). *Long Term Performance of a Porous Friction Course*. Publication FHWA/IN/JTRP-2009/22. Joint Transportation Research Program, Indiana Department of Transportation and Purdue University, West Lafayette, Indiana, 2010. doi: 10.5703/1288284314284.



- Minton, G. and Sutherland, R. (2010). Street Dirt: A Better Way of Measuring BMP Effectiveness, *Stormwater Magazine*, March/April, 12-22.
- Montgomery County Department of Environmental Protection (2002). *Street Sweeping for Pollutant Removal*, Montgomery County, MD. Retrieved October 5, 2011, from <http://h2o.enr.state.nc.us/nps/documents/MDstreetsweepingreview.pdf>
- Morin, E. D. (2006). Spatial Patterns in Thunderstorm Rainfall Events and their Coupling with Watershed Hydrological Response. *Adv. Water Resources*, 29: 843-860.
- National Asphalt Pavement Association (2009). *Thin Asphalt Overlays for Pavement Preservation*.
- National Research Council (2009). *Urban Stormwater Management in the United States*, Washington, DC: National Academies Press, Accessed August 1, 2013 at URL: [http://www.epa.gov/npdes/pubs/nrc\\_stormwaterreport.pdf](http://www.epa.gov/npdes/pubs/nrc_stormwaterreport.pdf).
- NCDOT (2008). *North Carolina Department of Transportation Stormwater Manual*.
- NCDOT and URS (2010). *Stormwater Runoff from Bridges, Final Report to Joint Legislation Transportation Oversight Committee, North Carolina Department of Transportation (2010)*, p. 8-2.
- NCHRP (2012). NCHRP Project 25-40, "Interim Literature Review & Interview Results – Long Term Performance and Life Cycle Costs of BMPs – Interim Version."
- NCRS (2013). *Marquam Bridge Area Soil Data*. Retrieved from NRCS Web Soil Survey: <http://websoilsurvey.sc.egov.usda.gov/App/HomePage.htm>
- Nelson, P. O., et al. (2001). *NCHRP Report 448: Environmental Impact of Construction and Repair Materials on Surface and Ground Waters*. TRB, National Research Council, Washington, DC.
- New York State Department of Transportation, Region 8. (2003). *Stormwater Facilities Operation and Maintenance Manual*, September.
- Nguyen, L. (2013). Washington State Department of Transportation, Olympia, Washington. Personal communication.
- North Carolina Department of Transportation. (2010). *Stormwater Control Inspection and Maintenance Manual*. NCDOT-HSP-2010-01.
- Nwaneshiudu, O. (2004). *Assessing Effects of Highway Bridge Deck Runoff on Near-By Receiving Waters in Coastal Margins Using Remote Monitoring Techniques*. Master's thesis, Texas A&M University. Available electronically from <http://hdl.handle.net/1969.1/1462>.
- Oregon State University, et al. (2006). *NCHRP Report 565: Evaluation of Best Management Practices for Highway Runoff Control*. Transportation Research Board of the National Academies, Washington D.C.
- Oshiro, R. and Fujioka, R. (1995). Sand, Soil, and Pigeon Droppings: Sources of Indicator Bacteria in the Waters of Hanauma Bay, Oahu, Hawaii. *Water Sci. Technol.*, 31(5-6): 251-254.
- Pagotto, C., Legret, M., and Cloirec, P. le, (2000). Comparison of the Hydraulic Behaviour and the Quality of Highway Runoff Water According to the Type of Pavement. *Water Research*, 34(18): 4446-4454.
- Palmer, M. (1982). Fecal Coliform Loadings from Birds on Bridges. *Can. J. Civil Eng.*, 10(2): 241-247.
- Perkins, R. (2010). *Alaska UTC and DOT and Public Facilities, Bridge Deck Runoff: Water Quality Analysis and BMP Effectiveness*, December, 2.
- Pitt, R. (1979). *Demonstration of Nonpoint Pollution Abatement through Improved Street Cleaning Practices*, EPA Report EPA-600/2-79-161.
- Pitt, R. (1985). *Project Summary Report – Characterizing and Controlling urban Runoff through Street and Sewerage Cleaning*. EPA/600/S2-85/038.
- Pitt, R. (2008). *National Stormwater Quality Database Version 3 Spreadsheet*. Retrieved August 1, 2013, from <http://rpitt.eng.ua.edu/Research/ms4/mainms4.shtml>
- Pitt, R. and Shawley, G. (1981). *A Demonstration of Non-Point Pollution Management on Castro Valley Creek*, San Francisco Bay Area National Urban Runoff Project. Prepared for Alameda County Flood Control and Water Conservation District and Water Planning Div.
- Pujara, K. (2012). Project interview with Karuna Pujara, Chief of Hydraulics, Maryland State Highway Administration (MDSHA) December 20, 2012.
- Records, P. A. (1964). *Marquam Bridge Under Construction Photo*. Retrieved September 5, 2013, from <http://www.portlandonline.com/auditor/index.cfm?&a=cehji&c=27928>
- Robertson, G. (2012). Personal communication with Gabe Robertson, Nebraska Department of Roads, December 17, 2012.
- Salmon, T. P. and W. P. Gorenzel (2005). *Cliff Swallows*. Publication 7482, University of California.
- San Francisco Stormwater Design Guidelines (2010) *Appendix A: BMP Fact Sheets*.
- Sartor, J. (1972). *Water Pollution Aspects of Street Surface Contaminants*, EPA Report EPA-R2-72-081.
- Sartor, J. and Boyd, G. (1972). *Water Pollution Aspects of Street Surface Contaminants*. Washington, D.C.: U.S. EPA.
- Schilling, J. (2005). *Street Sweeping – Report No. 1, State of the Practice*. North St. Paul: Washington Metro Watershed District.
- Schueler, T. (1987). *Controlling Urban Runoff – A Practical Manual for Planning and Designing Urban BMPs*. Metropolitan Washington Council of Governments.
- Sejkora, P. K. (2011). Colonies of Cliff Swallows on Highway Bridges: Point Sources of Fecal Indicator Bacteria in Surface Waters. *Journal American Water Resources Association*, 1-10. DOI: 10.1111/j.1752-1688.2011.00566.x.
- Selbig, W. and Bannerman, R. (2007). Evaluation of Street Sweeping as a Stormwater-Quality Management Tool in Three Residential Basins in Madison, Wisconsin. *U.S. Geological Survey Scientific Investigations Report 2007-5*.
- Smith, J. M. (2001). Extreme Rainfall and Flooding from Supercell Thunderstorms. *J. Hydromet.*, 2: 469-489.
- Smith, K. (2010). Quality of Stormwater Runoff Discharged from Massachusetts Highways, 2005-07. *U.S. Geological Survey Scientific Investigations Report 2009-5269, 198 p.* Retrieved from <http://pubs.usgs.gov/sir/2009/5269/>
- Smith, K. P. and Granato, G. E. (2010). *Quality of Stormwater Runoff Discharged from Massachusetts Highways, 2005-07*. U.S. Geological Survey Scientific Investigations Report 2009-5269. Available at <http://pubs.usgs.gov/sir/2009/5269/>.
- Southerland, R. (2011). Street Sweeping 101: Using Street Sweepers to Improve Water and Air Quality. *Stormwater Magazine*, Jan/Feb.
- Southerland, R. (2013). *Clean Streets Mean Clean Streams*, Webinar from Forester University, May 23.
- Sutherland, R. (2004). *Quantifying the Optimum Urban Runoff Pollutant Load Reductions Associated with Various Street and Catchbasin Cleaning Practices*.
- Teng, Z. (2004). In Situ Partial Exfiltration of Rainfall Runoff. II: Particle Separation. *Journal of Environmental Engineering*, 130(9): 1008-1020.
- Teng, Z. (2004). Particle Separation by In Situ Partial Exfiltration of Rainfall-Runoff. Critical Transitions in Water and Environmental Resources Management. Proceedings of the 2004 World Water and Environmental Resources Congress. Reston, VA.
- The Salt Institute. (2007). *The Snowfighter's Handbook: A Practical Guide for Snow and Ice Control 40th Year Edition*. Alexandria, VA: The Salt Institute.



- Thompson, P. L., and Kilgore, R. T. (2006). *Hydraulic Engineering Circular No. 14 Third Edition Hydraulic Design of Energy Dissipators for Culverts and Channels*. Arlington, VA: U.S. Department of Transportation Federal Highway Administration.
- U.S. D F&W (2003). *Migratory Bird Permit Memorandum*. Retrieved from <http://www.fws.gov/migratorybirds/RegulationsPolicies/Policies.htm>
- U.S. DOC, NOAA (n.d.). *Annual Climatological Summary*. US Department of Commerce, National Oceanic & Atmospheric Administration. Retrieved from <http://gis.ncdc.noaa.gov/map/cdo/?thm=themeAnnual>
- U.S. DOT (2013). *Incident Reports Database Search*. Retrieved from <https://hazmatonline.phmsa.dot.gov/IncidentReportsSearch/>
- U.S. DOT, FHWA (1993). *Design of Bridge Deck Drainage*, Hydraulic Engineering Circular No. 21, Washington, D.C. U.S. Department of Transportation, Federal Highway Administration.
- U.S. EPA (1988). *Design Manual Constructed Wetlands and Aquatic Plant Systems for Municipal Wastewater Treatment*. Cincinnati, OH.
- U.S. EPA (1993). *Guidance Specifying Management Measures for Sources of Nonpoint Pollution in Coastal Waters*. Office of Water, Washington DC, EPA 840-B-92-002 January.
- U.S. EPA (2010). *Source Water Protection Practices Bulletin: Managing Stormwater Runoff to Prevent Contamination of Drinking Water*. Retrieved from [http://www.epa.gov/safewater/sourcewater/pubs/fs\\_swpp\\_stormwater.pdf](http://www.epa.gov/safewater/sourcewater/pubs/fs_swpp_stormwater.pdf)
- U.S. EPA (2012). *National Pollutant Discharge Elimination System (NPDES) Fact Sheet: BMP Inspection and Maintenance*. Retrieved from [http://cfpub.epa.gov/npdes/stormwater/menuofbmps/index.cfm?action=factsheet\\_results&view=specific&bmp=91&minmeasure=5](http://cfpub.epa.gov/npdes/stormwater/menuofbmps/index.cfm?action=factsheet_results&view=specific&bmp=91&minmeasure=5)
- UDFCD (2010). *Urban Storm Drainage Criteria Manual: Volume 3 - Best Management Practices*. Denver, CO. Retrieved from <http://www.udfcd.org/downloads/pdf/critmanual/Volume%203%20PDFs/USDCM%20Volume%203.pdf>
- University of Florida (2009). *Practical Maintenance Guidelines for Stormwater Ponds*.
- University of Georgia (2000). *Crown Shape Factors and Volumes*.
- URS Corporation (2010). *Stormwater Runoff from Bridges, Final Report to Joint Legislation Transportation Oversight Committee*, July.
- URS Corporation (2010). *Targeted Aggressive Street Sweeping Pilot Program: Phase III Median Sweeping Study*. Prepared for the City of San Diego Stormwater Department, San Diego, CA.
- URS Corporation (2011). *Targeted Aggressive Street Sweeping Pilot Program: Phase IV Speed Efficiency Study*. Prepared for the City of San Diego Stormwater Department, San Diego, CA.
- Venner Consulting and Parsons Brinckerhoff (2004). *Environmental Stewardship Practices, Procedures, and Policies for Highway Construction and Maintenance*. AASHTO.
- Washington State Department of Ecology (2012). *Washington State Department of Transportation (WSDOT) National Pollutant Discharge Elimination System (NPDES) Permit*.
- Watershed Partner of Baltimore, Inc. (2014). *Healthy Harbor*. Retrieved from <http://www.healthyharborbaltimore.org/whats-happening-now/floating-wetlands>
- Weston Solutions. (2010). *City of San Diego Targeted Aggressive Street Sweeping Pilot Study Assessment Final Report, Prepared for City of San Diego Stormwater Department, San Diego, CA. 77 pp.*
- Wikipedia (2013). *Marquam Bridge*. Retrieved September 5 from [http://en.wikipedia.org/wiki/Marquam\\_Bridge](http://en.wikipedia.org/wiki/Marquam_Bridge)
- WSDOT (2005). *Research Proposal on BMP Maintenance Schedules*. Retrieved <http://www.wsdot.wa.gov/NR/rdonlyres/85610D43-2181-45C4-8ED2-4E1E8A269B49/0/researchproposal19.pdf>
- WSDOT (2011). *Highway Runoff Manual*. Retrieved from <http://www.wsdot.wa.gov/Publications/Manuals/M31-16.htm>
- WSDOT (2011). *I-5 to Medina: Bridge Replacement and HOV Project Final EIS*. Washington State Department of Transportation. Retrieved 2013, from <http://www.wsdot.wa.gov/Projects/SR520Bridge/EIS.htm#FEIS>
- WSDOT (2012). *Washington State Department of Transportation, December 18, 2012*.
- Wu, et al. (1998). *Characterization and Pollutant Loading Estimation for Highway Runoff*. *Journal of Environmental Engineering*, July.
- Yurek, R. (2012). *Project interview with Russ Yurek, MDSHA Maintenance Manager, May 31, 2012*.

## APPENDIX A

# Literature Review

## Project Overview

NCHRP Project 25-42 provides guidance for assessing potential water quality impacts and selecting BMPs for stormwater runoff from bridge decks and vehicle approaches. The study focuses on bridge structures that cross a waterway and discharge directly to the receiving water.

As an additional resource, the reader may find value in reviewing the report developed as a part of NCHRP Project 25-40, “Long-Term Performance and Life-Cycle Costs of Stormwater Best Management Practices,” which is currently in process and will develop guidelines for the selection and maintenance of highway related stormwater BMPs based on long-term performance and life-cycle costs. The NCHRP Project 25-40 literature review, survey, and associated interviews describe what DOTs and others are doing to understand maintenance needs and costs of post-construction stormwater BMPs. NCHRP Project 25-40 provides decision-making guidance on a number of key areas for highway BMPs, including:

- Defining and predicting long-term performance, service life, and maintenance costs, and selecting appropriate performance measures based on the best current information and practice;
- determining appropriate inspection schedules and procedures;
- determining appropriate maintenance schedules and procedures;
- incorporating long-term performance and life cycle costs into BMP selection processes;
- ensuring that funding, staffing, and training requirements are understood and considered by all relevant functional areas within the transportation agency for the selection, installation, inspection, and maintenance of BMPs; and
- identifying life-cycle data collection and analysis protocols to facilitate future evaluation of long-term BMP performance.

DOTs, cities, and counties have installed few structural BMPs to treat bridge decks. The quality of bridge deck runoff is generally comparable to non-bridge deck roadway runoff. Bridge decks represent only a small fraction of the impervious area of the highway system with runoff that reaches receiving waters. Still, agencies are concerned that the direct connection and untreated runoff from bridges may affect receiving waters; this project and individual DOTs are examining the environmental benefits that can be attained with additional structural and non-structural controls, as well as their costs.

## Literature Review Methodology

Generally, the literature review builds on a previous NCHRP research study (2002).<sup>1</sup> In addition to summarizing the most pertinent information in *NCHRP Report 474: Assessing the Impacts of Bridge Deck Runoff Contaminants in Receiving Waters, Volumes 1 and 2* and *Stormwater Runoff from Bridges* by the North Carolina Department of Transportation and URS (2010), literature on the topic was examined to accomplish the following:

- Define the characteristics of bridge deck runoff and its potential impacts on receiving waters.
- Identify runoff management strategies and how they are influenced by the physical constraints of bridge structures in new construction and retrofit scenarios.
- Identify appropriate mitigation strategies for bridge deck runoff, including structural controls and source control measures.
- Create a BMP selection tool for specific application on bridge decks.
- Accurately quantify “whole life” cost/benefit relationships for bridge deck runoff mitigation.

<sup>1</sup> NCHRP 25-42 panel meeting, project kick-off, December 4, 2012

## DOT Survey Methodology

The research team contacted a range of DOTs, including those known to be active in BMP and highway stormwater investigations to gain insight into current issues and practices relating to the management of stormwater discharge from bridges. Several state DOTs have stormwater research divisions that are engaged in original highway runoff assessments and were able to suggest additional studies that were utilized in the literature research effort. The research team performed a targeted survey, consisting of personal interviews, with the nine DOTs listed below.

- Florida DOT (FDOT)
- Massachusetts DOT (MassDOT)
- Louisiana Department of Transportation Development (LADOTD)
- Maryland State Highway Administration (MDSHA)
- Nebraska Department of Roads (NDOR)
- North Carolina Department of Transportation (NCDOT)
- South Carolina Department of Transportation (SCDOT)
- Texas Department of Transportation (TxDOT)
- Washington State Department of Transportation (WSDOT)

Interviews and email exchanges occurred between December 4, 2012 and January 29, 2013. A wide variety of practitioners participated, including bridge designers, hydraulic engineers, hydraulic division chiefs, landscape architects, and water quality program managers. Each DOT was asked the following questions, at minimum:

1. Are you currently treating bridge deck runoff?
2. Why/Why not?
3. If you do treat bridge runoff, what bridge runoff management strategies/BMPs do you use?
  - a. New construction strategies
  - b. Retrofit strategies
  - c. Source control approaches
  - d. Emerging BMPs for bridges
    - i. Additives to PFC to target removal of specific constituents of concern
    - ii. Alternatives to bridge materials (such as zinc coatings)
    - iii. Coatings for pavement to improve runoff sanitary quality
    - iv. Alternatives for mitigation of hazardous materials spills
    - v. Addition and use of smart controllers for maximizing BMP performance under constrained conditions
    - vi. Other
  - e. General design strategies

- f. How hazardous material spills are handled
- g. Endangered Species Act (ESA) implications
- h. Emerging BMPs for bridges
4. What issues and implementation barriers are you facing?
5. What methods and/or tools do you use to identify and select appropriate mitigation strategies for bridge deck runoff?
6. How do you assess cost-benefit of runoff mitigation strategies?
7. Do you have bridge runoff datasets you could share with the NCHRP 25-42 research team?

## Bridge Deck Runoff Characteristics and Receiving Water Impacts

According to National Bridge Inspection Standards, a bridge is a structure, including supports, erected over a depression or an obstruction, such as water, highway, or railway, and having a track or passageway for carrying traffic or other moving loads, and having an opening measured along the center of the roadway of more than 20 feet between under copings of abutments or spring lines of arches, or extreme ends of openings for multiple boxes. It may also include multiple pipes where the clear distance between openings is less than half of the smaller contiguous opening. For the purpose of the 25-42 study, the panel determined that bridges are highway structures directly discharging over open water.<sup>2</sup>

As owners of state highways and bridges, DOTs are interested in discerning whether contamination of water bodies from roads and bridges is significant and, if it is, what mitigation is appropriate. The most comprehensive prior research on the topic is *NCHRP Report 474* (2002) and a multi-agency study led by the North Carolina Department of Transportation (URS 2010).

### Bridge Deck Runoff Characteristics

The NCDOT report (URS 2010) found “no compelling evidence that bridge deck runoff in North Carolina is higher in [pollutants] typically associated with stormwater runoff as compared to runoff from other roadways.”<sup>3</sup>

Malina et al. (2005) showed that bridge deck runoff is generally not statistically different from highway runoff.<sup>4</sup> Malina’s

<sup>2</sup>NCHRP 25-42 panel meeting, project kick-off, December 4, 2012

<sup>3</sup>NCDOT/URS, Stormwater Runoff from Bridges, Final Report to Joint Legislation Transportation Oversight Committee, North Carolina Department of Transportation (2010), p. 4-5

<sup>4</sup>Malina et al., Characterization of Stormwater Runoff from a Bridge Deck and Approach Highway, Effects on Receiving Water Quality in Austin, Texas, TxDOT, (2005).

statistical data comparing bridge deck runoff event mean concentrations (EMCs) to the approach highway revealed only limited instances when parameters were significantly different from each other. Pollutant concentrations reflected (same order of magnitude) or were less than average historical highway runoff concentrations, such that Malina concluded that highway runoff data can be used as a conservative approximation of bridge deck runoff quality.<sup>5</sup> At Barton Creek, Malina found that loading of all measured water quality constituents was minimal, with “no substantial adverse impact to the receiving streams . . . observed or indicated by bridge deck runoff from the three monitored sites.”<sup>6</sup> Loadings from upstream sources were several orders of magnitude greater.

As Nwaneshiudu and others have pointed out, “Most of the pollution found in highway runoff is both directly and indirectly contributed by vehicles such as cars and trucks. The constituents that contribute the majority of the pollution, such as metals, chemical oxygen demand, oil and grease, are generally deposited on the highways.”<sup>7</sup> Jongedyk (1999) and Dupuis (2002) list common pollutants in highway runoff as metals, inorganic salts, aromatic hydrocarbons, suspended solids, and materials that are a result of wear and tear on a vehicle, such as oil, grease, rust, and rubber particles.<sup>8</sup> Traffic patterns, bridge characteristics, antecedent dry periods, seasonal cumulative rainfall, rainfall intensity, and land use are contributing factors as well,<sup>9</sup> and atmospheric deposition can be the major source of some parameters, such as trace metals, in urban watersheds (Sabin et al., 2005).<sup>10</sup> Splash from surface water on roadways rinses the underside of vehicles and surface water carries salt that may have been applied to the road in winter maintenance and pollutants from air deposition to receiving water if sources are not controlled or pollutants are not detained.

<sup>5</sup> Malina et al., Characterization of Stormwater Runoff from a Bridge Deck and Approach Highway, Effects on Receiving Water Quality in Austin, Texas, TxDOT, (2005).

<sup>6</sup> Malina et al., Characterization of Stormwater Runoff from a Bridge Deck and Approach Highway, Effects on Receiving Water Quality in Austin, Texas, TxDOT, (2005).

<sup>7</sup> Nwaneshiudu, Oke (2004). Assessing effects of highway bridge deck runoff on near-by receiving waters in coastal margins using remote monitoring techniques. Master's thesis, Texas A&M University. Texas A&M University. <http://hdl.handle.net/1969.1/1462>

<sup>8</sup> Jongedyk, H. 1999. FHWA Environmental Technology Brief: Is Highway Runoff a Serious Problem? Washington DC: Federal Highway Administration and Dupuis (2002)

<sup>9</sup> Kayhanian, M., A. Singh, C. Suverkropp, and S. Borroum. 2003. Impact of Annual Average Daily Traffic on Highway Runoff Pollutant Concentrations. *Journal of Environmental Engineering* 129 (11): 975-990. Kayhanian, M., C. Suverkropp, A. Ruby, and K. Tsay. 2007. Characterization and Prediction of Highway runoff Constituent Event Mean Concentration. *Journal of Environmental Management* 85 (1): 279-295

<sup>10</sup> Kayhanian et al., (2003) and atmospheric deposition can be the major source of some parameters, such as trace metals, in urban watersheds (Sabin et al., 2005) as cited in NCDOT

Metals have acute and chronic toxicity to aquatic life, particulates are the carriers of other pollutants and sedimentation effects on aquatic habitat, nutrients can contribute to eutrophication and salts have aquatic life toxicity effect and affects drinking water supply taste.<sup>11</sup>

Roadway stormwater runoff data has been independently collected and studied by many sources.<sup>12</sup> FHWA's *Effects of Highway Runoff on Receiving Waters—Volume IV Procedural Guidelines for Environmental Assessments* (Dupuis and Kobringer, 1985) identified several parameters that affect the magnitude of pollution in highway runoff, which can be grouped in the following general categories:<sup>13</sup>

- *Traffic characteristics*—speed, volume, vehicular mix (cars/trucks), congestion factors, and state regulations controlling exhaust emissions;
- *Highway design*—pavement material, percentage impervious area, and drainage design;
- *Maintenance activities*—road cleaning, roadside mowing, herbicide spraying, road sanding/salting, and road repair;
- *Accidental spills*—sand, gravel, oils, and chemicals.

Generally, roadway runoff water quality data is used as an approximation for the pollutant profile of bridge deck runoff (Dupuis 2002). Common highway runoff pollutants and their primary sources include the following, as outlined in multiple studies to date:

**Particulates** Pavement wear, vehicles, atmosphere  
**Nitrogen, Phosphorus** Atmosphere, roadside fertilizer application

**Lead** Tire wear, auto exhaust

**Zinc** Tire wear, motor oil, grease

**Iron** Auto body rust, steel highway structures, moving engine parts

**Copper** Metal plating, brake lining wear, moving engine parts, bearing and bushing wear, fungicides and insecticides

**Cadmium** Tire wear, insecticides

**Chromium** Metal plating, moving engine parts, brake lining wear

**Nickel** Diesel fuel and gasoline, lubricating oil, metal plating, brake lining wear, asphalt paving

**Manganese** Moving engine parts

<sup>11</sup> Perkins, R., and Hazirbaba, Y., Alaska UTC and DOT & Public Facilities, Bridge Deck Runoff: Water Quality Analysis and BMP Effectiveness, December 2010, p. 11

<sup>12</sup> Gupta et al., 1981; FHWA, 1990; Sansalone and Buchberger, 1997; Barrett et al., 1998, Kayhanian et al., 2007. Barrett, M. E., Irish, B. L., Lesso, G. W. III., Malina, J. F. Jr., and Charbeneau, R. J. (1998). “Characterization of highway runoff in Austin, Texas, area,” *Journal of Environmental Engineering-ASCE*, 124 (2), 131-137

<sup>13</sup> FHWA's Effects of Highway Runoff on Receiving Waters – Volume IV Procedural Guidelines for Environmental Assessments (Dupuis and Kobringer, 1985)



**Cyanide** Anti-cake compound used to keep deicing salt granular

**Sodium, Calcium, Chloride** Deicing salts

**Sulphate** Roadway materials, fuel, deicing salts

**Petroleum** Spills, leaks or blow-by of motor lubricants, antifreeze and hydraulic fluids, asphalt surface leachate

## The Impact of Curbed vs. Uncurbed Sections on Bridge Decks

Some research has pointed to the accumulation of pollutants and sediments along curbed sections of bridge decks. Wu and Allen performed research on stormwater runoff in North Carolina. The majority of Wu and Allen's (2001) study sites found runoff concentrations from bridges similar to previously published urban runoff data for the Charlotte, NC area, however, the higher levels of pollutants on one bridge prompted the researchers to postulate that the bridge deck curb (railing) wall might be responsible for accumulation of pollutants.<sup>14</sup> High traffic and a lack of (pervious surface) were also considered to be factors.

## Bridge Deck Impacts to Receiving Water

A variety of variables (rural vs. urban environment, average daily traffic, curbed vs. non-curbed section, climate, runoff volume, time from previous rainfall event, receiving water chemistry and/or flow) can influence the degree of impact bridge deck runoff may have on receiving waters. The following examination of research literature is divided into that occurring in the last decade or so and pre-2000 research.

### Early Research Findings

In his 1999 work for FHWA, Dupuis (1999) described 19 different methods to manage, assess, and identify bridge deck runoff that could potentially affect receiving waters. Dupuis suggested consideration of average daily traffic in the area, if the bridge is a retrofit or a replacement bridge, and usage and hydrology of the receiving water; e.g., if it is freshwater, saltwater, drinking water supply, lake, etc.<sup>15</sup>

<sup>14</sup>Jy S. Wu and Craig J. Allen, *Sampling and Testing of Stormwater Runoff from North Carolina Highways* (2001). Wu, J. S., Allan, J. C., Saunders, W. L., and Evett, J. B. (1998). "Characterization and pollutant loading estimation for highway runoff," *Journal of Environmental Engineering-ASCE*, 124, (7), 584-592

<sup>15</sup>Dupuis, T., National Cooperative Highway Research Program (NCHRP) Report 474: *Assessing the Impacts of Bridge Deck Runoff Contaminants in Receiving Waters*, Volume 1 Final Report (2002).

A relatively small number of earlier studies focused on bridge deck runoff prior to Dupuis's research; these included Yousef et al. 1984; Kszos et al. 1990; and Dupuis et al. 1985. A 1998 study by CH2M Hill sampled bridge deck runoff at two sites. Predictive models for highway runoff have estimated water quality based on average daily traffic (ADT), urban vs. rural location, vehicle traffic during storms, and other variables (Barrett et al. 1995; Driscoll et al. 1990, etc.). Caltrans, based on analysis of its own data (Racin et al. 1982) also determined in 1992 that fewer than 30,000 vehicles during a storm, equated to mean 30,000 ADT, would have ". . . little or no impact, because corresponding constituent masses were relatively small."<sup>16</sup>

A 1996 Florida study, *Effectiveness of a Stormwater Collection and Detention System for Reducing Constituent Loads from Bridge Runoff in Pinellas County*, Stoker (1996) found evidence of "first flush" impacts, in particular that:<sup>17</sup>

- Most constituents measured in stormwater runoff from the bridge were greatest at the beginning of the storm.
- Quality of stormwater runoff from the bridge varied with season, runoff volume, and the antecedent dry period.
- Maximum values of most measured constituents occurred in the spring of 1994 when rainfall was minimal.
- Maximum stormwater loads of nitrogen, iron, aluminum, nickel, and zinc occurred on August 22, 1995, also the date of maximum measured storm volume.

In his meta-analysis of existing studies, for his 2002 NCHRP Report, Dupuis said while several studies had shown that direct drainage to some types of receiving waters (e.g., small lakes) could cause localized increases in certain pollutant concentrations, most studies did not consider whether such increases adversely affected the biota or other receiving water uses. The only comprehensive study of bridge runoff at that time, FHWA's I-94/Lower Nemahbin Lake site, found that although direct scupper drainage increased metals concentrations in near-scupper surficial sediments, biosurveys and in situ bioassays found no significant adverse effects on aquatic biota near the scuppers. FHWA concluded that for lower traffic volume bridges at least, runoff had a negligible impact, based on results of its Phase III program (Dupuis et al. 1985a), which included extensive bioassay testing and field study at three sites that had traffic volume less than 30,000 vehicles per day (VPD).

<sup>16</sup>NCDOT/URS, *Stormwater Runoff from Bridges, Final Report to Joint Legislation Transportation Oversight Committee*, North Carolina Department of Transportation (2010), p. 22, citing Report 474, citing Racin, 1998.

<sup>17</sup>Stoker, *Effectiveness of a Stormwater Collection and Detention System for Reducing Constituent Loads from Bridge Runoff in Pinellas County*, Florida Stoker (1996)



## Literature Research over the Last Decade

The primary recent US studies assessing the effect of bridge deck runoff on receiving water beneficial uses (NCDOT/USGS/URS, 2010, NCHRP, 2006, and Malina et al. 2005) concluded that bridge deck runoff is not a primary source of receiving water impairments; however, deicing practices, bridge components (galvanized metal railing), and sensitive or otherwise outstanding resource waters merit further consideration. In addition, ADT remains an indicator of potentially higher pollutant concentrations in runoff.

*NCHRP Report 474* (Dupuis 2002) reviewed scientific and technical literature addressing bridge deck runoff and highway runoff performed by FHWA, USGS, state DOTs, and universities, focusing on the identification and quantification of pollutants in bridge deck runoff and how to identify the impacts of bridge deck runoff pollutants to receiving waters using a weight-of-evidence approach. Dupuis et al. found no clear link between bridge deck runoff and biological impairment, though salt from deicing could be a concern. Other conclusions were as follows:<sup>18</sup>

- Undiluted highway runoff can exceed federal and state ambient water quality criteria, but this alone does not automatically result in negative effects to receiving waters.
- The quality and use of receiving waters, as well as the flow path and possible transformations of pollutants in runoff, must be considered independently of runoff loading.
- Lead concentrations in highway runoff have significantly decreased since the 1970s due to the phase-out of leaded gasoline.
- Direct discharge to some types of receiving streams, primarily small streams and lakes, can lead to localized increases in pollutant concentrations in sediment and, in some cases, aquatic biota. However, whether localized effects adversely affected biota was unknown.
- Comparison of historic metal toxicity research to present day data may prove difficult due to the measurement of metal toxicity shifting from total metals to dissolved metals.
- The ability of sediment to accumulate metals, polycyclic aromatic hydrocarbons (PAHs), nutrients, and other compounds warrants further research of sediment quality impacts and further development of standards and criteria.
- The results of bioassay testing using whole effluent toxicity from various studies have been mixed. For the studies that do show some level of toxicity, the runoff samples were high in salt content from deicing activities. The bio-

assay methods used by these studies may not be appropriate for evaluating stormwater runoff. Most bioassays expose the organism being testing continuously to runoff for long periods of time. However, stormwater runoff is delivered to receiving streams in short, intermittent time frames.

*NCHRP Report 474* noted,

“Highways typically constitute a very small fraction of a watershed’s total drainage area, and bridges often constitute a small portion of the highway drainage area. Thus, highways often, but not always, contribute a small fraction of the overall pollutant load to a given receiving water body, and bridges contribute even less.”

According to *NCHRP Report 474*, “This circumstance provides opportunities to consider and implement common-sense solutions such as providing enhanced pollutant removal somewhere else in the ROW, or even somewhere else in the watershed (i.e., off-site mitigation, or pollutant trading).”<sup>19</sup> Perkins and Hazirbaba (2010) also concluded that “contamination is slight, unlikely to affect the receiving waters, and not sufficient to warrant concern.”<sup>20</sup>

Nwaneshiudu assessed the quantity and quality of stormwater runoff from a bridge that spans Clear Creek as a part of highway FM 528 near Houston, Texas. He found that an old galvanized metal bridge railing was contributing to “zinc concentrations ten times higher than the culvert and creek samples and higher than the USEPA standard.”<sup>21</sup> Nwaneshiudu also concluded that:<sup>22</sup>

- Total copper and dissolved copper concentrations from the bridge deck runoff were also consistently higher than the USEPA standard.
- Total lead and dissolved lead concentrations from bridge deck runoff were orders of magnitude less than the USEPA standard.
- Chemical oxygen demand (COD) concentrations from bridge deck runoff were significantly less than values from a nationwide survey of highway runoff data (FHWA 1990).

<sup>19</sup>Dupuis, T., National Cooperative Highway Research Program (NCHRP) Report 474: Assessing the Impacts of Bridge Deck Runoff Contaminants in Receiving Waters, Volume 1 Final Report (2002), p. 4.

<sup>20</sup>Perkins, R., and Hazirbaba, Y., Alaska UTC and DOT & Public Facilities, Bridge Deck Runoff: Water Quality Analysis and BMP Effectiveness, December 2010, p. 4.

<sup>21</sup>Nwaneshiudu, Oke (2004). Assessing effects of highway bridge deck runoff on near-by receiving waters in coastal margins using remote monitoring techniques. Master’s thesis, Texas A&M University. Texas A&M University. <http://hdl.handle.net/1969.1/1462>.

<sup>22</sup>Nwaneshiudu, Oke (2004). Assessing effects of highway bridge deck runoff on near-by receiving waters in coastal margins using remote monitoring techniques. Master’s thesis, Texas A&M University. Texas A&M University. <http://hdl.handle.net/1969.1/1462>.

<sup>18</sup>Dupuis, T., National Cooperative Highway Research Program (NCHRP) Report 474: Assessing the Impacts of Bridge Deck Runoff Contaminants in Receiving Waters, Volume 1 Final Report (2002), as cited in NCDOT, 2010.

## A-6

- Phosphate concentrations in the creek were on average much higher than concentrations from bridge deck runoff.
- Total nitrogen and total Kjeldahl nitrogen (TKN) concentrations showed no trend, but were sometimes above the USEPA standard.
- Total suspended solids (TSS) and volatile suspended solids (VSS) concentrations showed no consistency or noticeable trends and were relatively low. Total suspended solids concentrations were highest in the creek.

Kayhanian et al. (2003) performed a statistical analysis on a Caltrans highway runoff dataset of monitoring data from 83 highway sites over a 4-year period. Kayhanian's multiple linear regression analysis revealed that ADT, event rainfall, cumulative seasonal precipitation, and antecedent dry period each had a similar, statistically significant effect on pollutant concentrations; however, ADT is the only parameter that can be reasonably quantified by transportation agencies in advance of a project being built.<sup>23</sup> Thus ADT remains an "indicator of potentially high pollutant concentrations and can be useful for locating sites which would benefit from potential BMP retrofit installations. However, because ADT alone cannot accurately predict whether pollutant concentrations at a particular site will be higher than another, it should not be used as a sole indicator of impact."<sup>24</sup> Sabin and Schiff (2008) thought that recent research linking atmospheric deposition of metals to proximity to urban areas and accounting for a significant portion of metal inputs to runoff suggest that defining urban roadways by population is appropriate.<sup>25</sup>

In 2010, North Carolina DOT concluded a legislatively mandated study of 50 bridges. The objectives of this study were to (1) quantify the constituents in stormwater runoff from bridges across the state, (2) evaluate the treatment practices that can be used to reduce constituent loadings to surface waters from bridges, and (3) determine the effectiveness of the evaluated treatment practices.<sup>26</sup> NCDOT also summarized conclusions from previous studies:<sup>27</sup>

- Pollutant loadings from bridge decks to a receiving stream can be minimal when compared to pollutant loadings from other watershed sources.

<sup>23</sup> Kayhanian et al. (2003) cited in NCDOT 4-34

<sup>24</sup> NCDOT/URS, Stormwater Runoff from Bridges, Final Report to Joint Legislation Transportation Oversight Committee, North Carolina Department of Transportation (2010), p. 4-34

<sup>25</sup> Sabin and Schiff, 2008, cited in NCDOT 4-35

<sup>26</sup> USGS, North Carolina Water Science Center, Water quality characterization of bridge deck runoff in NC [http://nc.water.usgs.gov/projects/bridge\\_runoff/overview.html](http://nc.water.usgs.gov/projects/bridge_runoff/overview.html)

<sup>27</sup> URS, Stormwater Runoff from Bridges, Final Report to Joint Legislation Transportation Oversight Committee, North Carolina Department of Transportation (2010), p. 2-3

- Specific instances of elevated parameters, particularly zinc, may be linked to galvanized bridge materials.
- While parameter concentrations in bridge deck runoff can exceed nationwide benchmarks, no widespread link between bridge deck runoff and negative impacts to receiving streams has been shown.
- Deicing activities and pollutant accumulation in sediment are potential sources of localized toxicity that require further study.

NCDOT concluded that these observations "support the concept that surface water quality protection may be better served by managing stormwater runoff on a watershed scale as opposed to focusing management efforts specifically on bridges. In addition, there may be opportunities to improve water quality by identifying and controlling the source of pollutants (e.g., by replacing certain bridge materials)."<sup>28</sup> NCDOT also developed a treatment BMP selection framework and estimated costs.

NCDOT's study resulted in a number of major observations, including the relatively minor importance of ADT and the relative importance of the urban-rural distinction:<sup>29</sup>

- Similar to previous studies, ADT showed a small influence on pollutant distributions with only total recoverable zinc, copper, and cadmium significantly higher for high ADT bridges.
- Differences between total recoverable metals, particularly nickel, aluminum, manganese, iron, chromium, and lead, tend to track significant differences in total suspended solids. These metals tend to be predominantly particulate-bound, with the exception of manganese (Blazier 2003). Therefore, these results may reflect a difference in solids generation by bridge characteristic.
- Of all the characteristics investigated, the urban versus rural designation appears to have the most influence on pollutant loading. All solids parameters studied were higher in urban areas, as well as most total recoverable metals and dissolved copper and lead. Similar relationships were also noted for the asphalt versus concrete hypothesis testing (pollutant loading from asphalt surfaces is higher), but most urban bridges were also concrete.
- For characteristics in which total recoverable arsenic showed a significant difference (statewide vs. regional, regional vs. subregional, urban vs. rural, piedmont vs. coastal, and blue ridge vs. coastal), the higher arsenic mean and median was

<sup>28</sup> NCDOT/URS, Stormwater Runoff from Bridges, Final Report to Joint Legislation Transportation Oversight Committee, North Carolina Department of Transportation (2010), p. 2-3

<sup>29</sup> NCDOT/URS, Stormwater Runoff from Bridges, Final Report to Joint Legislation Transportation Oversight Committee, North Carolina Department of Transportation (2010), p. 4-36

associated with the characteristic opposite to other total recoverable and dissolved metals and TSS. Because a major source of arsenic in stormwater runoff is air deposition from point sources (e.g., coal-fired power plants), total recoverable arsenic loads in highway runoff may be related to atmospheric pathways. Higher total recoverable arsenic distributions were noted for coastal bridges primarily. Even though total recoverable arsenic was significantly higher in regional bridges as compared to statewide and subregional bridges, both regional bridge sites in this analysis are also coastal sites.

- Significantly higher nutrients were generally found in piedmont, regional, and subregional bridges and were associated with asphalt pavement. Surprisingly, only nitrate+nitrite and dissolved orthophosphate were significantly different between urban and rural sites. Further, the nitrate+nitrite distribution was higher in urban sites as opposed to rural sites.
- Dissolved metals, as a whole, did not exhibit any strong relationship with any one bridge characteristic. Dissolved zinc was only significantly different based on bridge surface material, with higher concentrations noted for asphalt bridges. The dissolved lead distribution was also higher in asphalt bridges. Dissolved copper and dissolved lead concentrations were significantly higher in piedmont and urban bridges. Dissolved cadmium concentrations were higher for statewide and regional bridges, but showed no significant difference between urban and rural bridges and high and low ADT bridges.

Further studies are underway, such as source assessment and monitoring to determine levels of bacteria from the Virginia Dare Bridge.<sup>30</sup> Shellfish contamination and contribution of bacteria from bridge decks are of potential concern in some coastal states. Monitoring for bacteria in bridge deck runoff was not included in NCDOT's monitoring plan for their 2010 report because of the logistics required for the short holding times and available certified labs.

### *Impact of Bridge Deck Runoff on Sediment Quality*

NCDOT (2010) found no statistically significant differences in sediment inorganic or organic concentrations downstream from no-direct discharge bridges as compared with direct discharge bridges or downstream as compared with upstream locations. Overall, the North Carolina analysis of streambed sediment did not indicate any impacts of bridge

deck runoff on sediment quality. Ecoregional differences were observed for some analytes, but these differences seemed to be associated with naturally occurring conditions or upstream anthropogenic influences. Furthermore, where sediment quality benchmarks were exceeded, except for lead and mercury, the exceedances were found to be independent of the discharge drainage design (i.e., direct versus indirect) and were also found to occur either upstream of the bridge deck, or at similar levels upstream and downstream, implicating sources other than bridge deck runoff.<sup>31</sup>

### *Stormwater Quantity Impacts from Bridges*

Bridge deck runoff quantity can be characterized by runoff volume and peak flow rate, both of which are considerations when evaluating the potential hydrologic effect of bridge deck runoff on receiving streams. NCDOT (2010) discussed how stormwater quantity from bridge deck runoff could negatively impact receiving streams.<sup>32</sup>

The construction of any new transportation facility, whether that facility includes a bridge deck or not, will increase impervious area in a watershed. Increasing impervious area increases both runoff volume and peak flow rates. These changes, if not properly mitigated, can negatively impact receiving streams by causing hydromodification, or the alteration of the hydrologic characteristics of a receiving stream that can negatively impact water quality (USEPA 2007).

Some characteristics of hydromodification include increased movement and deposition of stream sediment, channel modification as receiving streams attempt to accommodate larger flows, stream bank erosion, increased stream turbidity, and changes in flow patterns. Such changes to the receiving stream can degrade water quality below intended uses and negatively impact biological habitat (USEPA 2007).

Hydromodification should not be an issue however from bridge decks alone, since the runoff coefficient is identical to rainfall on the receiving water. NCDOT also discussed the risks of increased sediment deposition as runoff flows overland from the bridge to the stream bank, increasing potential toxicity and reducing available sunlight, with detrimental impacts to aquatic communities. Design is a factor:<sup>33</sup>

For bridges that drain runoff via gutter flow and bridge end collectors or closed drainage systems, there is a possibility for erosion

<sup>30</sup>NCDOT/URS, Stormwater Runoff from Bridges, Final Report to Joint Legislation Transportation Oversight Committee, North Carolina Department of Transportation (2010), p. 8-5

<sup>31</sup>NCDOT/URS, Stormwater Runoff from Bridges, Final Report to Joint Legislation Transportation Oversight Committee, North Carolina Department of Transportation (2010), p. 4-44

<sup>32</sup>NCDOT/URS, Stormwater Runoff from Bridges, Final Report to Joint Legislation Transportation Oversight Committee, North Carolina Department of Transportation (2010), p. 2-2

<sup>33</sup>NCDOT/URS, Stormwater Runoff from Bridges, Final Report to Joint Legislation Transportation Oversight Committee, North Carolina Department of Transportation (2010), p. 2-2

to occur between the pipe outlet (typically located on the bridge embankment or near a bent) and the receiving stream. For bridges that discharge runoff from the deck using deck drains, lack of energy dissipation at the point of physical impact between runoff and the land beneath the bridge deck may also cause erosion. The likelihood of localized erosion can be verified through the use of professional judgment (e.g., bridge deck height) or erosion prediction through calculation of flow velocities in conveyance and at points of discharge.

### *Bridge Impacts at a Watershed Level*

Dupuis proposed comparison of pollutant loading from bridge decks to other sources in the watershed as one piece of evidence considered in assessing the potential impact of bridge deck runoff on the receiving waters (Dupuis, NCHRP 2002, vol. 2). Likewise, Malina et al. (2005a; 2005b) compared pollutant loads estimated for bridge decks in Texas to their receiving water loads and concluded that relative contributions from bridge decks were very small and did not result in adverse impact to receiving waters.

Watershed contributions were also among the most important identified in the NCDOT report given its emphasis on urban vs. rural differences.<sup>34</sup>

The hydrologic and water quality effects of increased stormwater runoff and pollutant loading on receiving waters have been well studied and documented, and these effects have been linked to land use change and urbanization (Burton and Pitt, 2001; Calder, 1993; Urbonas and Roesner, 1993). Effects of increased stormwater runoff include stream bank and channel erosion, worsened flooding, and an increased ability for runoff to detach sediment and transport pollutants downstream. Effects of increased pollutant loading include eutrophication of receiving waters and subsequent hypoxia due to excessive nutrients, toxicity of aquatic life or inedible fish caused by loading of metals and organics, and limited contact recreation and shellfish consumption due to bacteria. In an effort to better mitigate these effects, the National Research Council has recently recommended a shift in stormwater management and regulatory permitting to a more watershed based approach, where discharge permits are based on watershed boundaries rather than political boundaries. (National Research Council 2008)

To provide perspective on the relative contribution of runoff quantity and pollutant loads from bridge decks in North Carolina as compared to total watershed contributions, NCDOT's approach characterized runoff volume from bridges over waterways across the state and compared impervious area, runoff volume, peak flow rates, and pollutant loads estimated for selected bridge decks to those amounts estimated for their receiving waters. Three geographically

<sup>34</sup>NCDOT/URS, Stormwater Runoff from Bridges, Final Report to Joint Legislation Transportation Oversight Committee, North Carolina Department of Transportation (2010), p. 4-54-4-56

distributed bridge sites with different watershed areas were selected for the site-specific evaluations. To respond to the trend of managing and regulating stormwater according to a more watershed-based approach (National Research Council 2008), NCDOT took a watershed-based perspective on runoff volume to weigh the hydrologic effect of bridge deck runoff.<sup>35</sup>

To provide this perspective, runoff volume and impervious area attributed to bridge decks were compared to total watershed contributions for three sites: Black River, Little River, and Swannanoa River . . . these three sites were also evaluated through direct comparison of concentration thresholds to measured end of pipe values and through mixing analysis. The three sites are spatially distributed in each of the three ecoregions in North Carolina and represent various sized watershed areas (i.e., stream drainage areas at the point of bridge crossing) . . . Deck area for all bridges in each watershed is a small fraction (below 0.05% in all cases) of the total watershed area. With the exception of the Swannanoa River site, the ratio of deck area for all bridges to total watershed areas is well below 1%. Overall, impervious area introduced by bridge decks in these watersheds is relatively small when compared to total impervious area and very small when compared to the total watershed area.

NCDOT's weight-of-the-evidence approach concluded that "bridge deck runoff does not have a widespread effect on receiving waters and that NCDOT's current use of stormwater control measures for the mitigation of bridge deck runoff is protective of surface waters;" results indicated the following:<sup>36</sup>

- Quality and pollutant loading in bridge deck runoff is similar to roadway and urban runoff; bioassessments made upstream and downstream of bridges provided similar results; periodic toxicity of bridge deck runoff is possible, but not common (periodic toxicity observed may be linked to roadway deicers);
- Bridge deck runoff did not contribute to stresses from organics or nutrient enrichment;
- Potential erosion due to concentrated flow from bridge decks could impact receiving waters.
- NCDOT currently implements structural stormwater control measures (BMPs) to treat discharges to sensitive waters and BMPs to reduce potential erosion. Consequently, results of the study indicate that NCDOT's current approach to BMP implementation is protective of state surface waters.

Malina's results were similar. Malina, et al. (2005) concluded that "mass loadings of constituents contributed by the run-

<sup>35</sup>NCDOT/URS, Stormwater Runoff from Bridges, Final Report to Joint Legislation Transportation Oversight Committee, North Carolina Department of Transportation (2010), p. 4-64

<sup>36</sup>NCDOT/URS, Stormwater Runoff from Bridges, Final Report to Joint Legislation Transportation Oversight Committee, North Carolina Department of Transportation (2010), p. 8-1



off from bridge decks were minimal compared to the mass loads of constituents carried by the respective receiving stream.” NCDOT pointed out that loads should be evaluated for meeting specific stormwater management goals, such as goals associated with waste load allocations, pollutant trading, stormwater banking programs, or off-site mitigation, as required by a particular program or regulation.

### *Linking Bridge Deck Runoff to Receiving Streams*

Linking bridge deck runoff to conditions in receiving streams is more difficult than measuring constituents in runoff. In its work for NCDOT, URS noted, “Despite a significant amount of stormwater characterization in the literature, no standard method exists for evaluating post-construction stormwater concentrations in an impairment context,”<sup>37</sup>

In general, results from a particular stormwater monitoring project are compared to national compendiums of stormwater data or to previous locally collected stormwater monitoring programs. While such comparisons are convenient for assessing stormwater runoff concentrations, they do not provide insight into the impacts of stormwater runoff on a particular watershed. Logically, if a particular concentration is not contributing to impairment for a receiving stream with lower water quality standards, no significant stormwater treatment should be necessary. The same concentration profile might require sophisticated BMPs when paired with a high quality drinking water source. Therefore, efficient and cost-effective stormwater management, including BMP selection, becomes a function of evaluating stormwater characterization data against receiving stream surface water quality goals.

Linking stormwater runoff to overall degradation in receiving streams is an emerging area in stormwater management research. Fundamentally, it is understood that increased urbanization causes both hydrologic and water quality impairments to receiving streams (Burton and Pitt 2002). However, the specific processes and chemical pathways for the impact of stormwater runoff from transportation facilities, isolated from the impact of other nonpoint sources in the watershed are not currently well understood.

## Runoff Management on Bridge Decks

Historically, bridge engineers have designed stormwater drainage systems to drain directly into receiving waters through deck drains, scupper systems, or simply open-rail

drainage. This was the low-cost, practical way to get water off the bridge quickly and maintain safe driving conditions. Virtually all bridges constructed in the United States still have these types of drainage systems.

NCDOT’s 2010 report describes typical conveyance methods in the context of a bridge’s physical constraints, as follows:

In general, as rain falls on a bridge deck, it drains in the direction of roadway cross slope to the edge of the bridge deck. From there, runoff is conveyed by gutters and either exits through deck drains evenly spaced on the bridge deck or is conveyed off the bridge deck into grated inlets or other collection system. For some bridge drainage systems, runoff will free fall from the deck drains onto the roadway embankment, the overbank, or in some cases, directly into a body of water. Deck drains discharging directly into a water body is common on long coastal bridges, where collection and conveyance of stormwater is not feasible due to the size and cost of systems required. For older bridges, gutters and deck drains were not provided and runoff generally would sheet flow directly off the bridge deck onto the overbank or into a waterway.

Requests to treat bridge deck runoff are becoming more common. Some state and local governments now encourage or require new projects to be constructed to drain runoff to land to allow for some form of active or passive improvement of the stormwater before it is discharged to the receiving water or infiltrated into the ground without being directly discharged to the receiving water. USEPA has recommended diversion of runoff to land for treatment, restricted use of scupper drains on bridges less than 400 feet in length and on bridges crossing very sensitive ecosystems, or provision of equivalent urban runoff treatment in terms of pollutant load reduction elsewhere on the project to compensate for the loading discharged off the bridge.<sup>38</sup> NCDOT effectively avoided the physical constraints of treatment by taking the latter option when the agency constructed a wetland in a rest area and treated 20+ acres to offset 14 bridges. NCDOT quantified the costs and benefits and showed this was much more cost-effective than retrofitting the bridges.<sup>39</sup>

## Design Constraints with Stormwater Collection and Conveyance on Bridges

### General Discussion of Design Challenges

Stormwater collection and conveyance is difficult on bridges. In the case of longer, flatter bridges, sufficient elevation does not exist to drain runoff by gravity for treatment at bridge approaches. Even when water can be drained to the

<sup>37</sup>NCDOT/URS, Stormwater Runoff from Bridges, Final Report to Joint Legislation Transportation Oversight Committee, North Carolina Department of Transportation (2010), p. 4-17 and 4-18

<sup>38</sup>USEPA, Coastal Zone Act Reauthorization Amendments, B., Management Measure for Bridges <http://water.epa.gov/polwaste/nps/czara/ch4-7b.cfm>

<sup>39</sup>Project interview with North Carolina DOT (Matt Lauffer), USGS (Chad Wagner), and URS Corp., December 20, 2012



abutment, on-deck spread takes valuable surface area and may require construction of a larger bridge deck, with the physical and carbon footprint that entails. Bridge girders, visibility, and space constraints complicate piping. Maintenance is also more complex, dangerous, and expensive on bridges. Altogether, collection system cost and technical feasibility, in many cases, make conveyance of runoff to the abutment area for treatment impractical and raises questions about the benefits in relation to the cost.

The current practice for mitigation of bridge deck runoff water quality via treatment typically adds a collection system to bridge deck drains to route the runoff to the abutment area. This is problematic for many installations. For long-span bridges, the conveyance system can become relatively large, introducing engineering, aesthetic and maintenance issues into the bridge design. For example, the design team completed a preliminary study for piping runoff to the abutment of the new San Francisco–Oakland Bay Bridge for treatment. The preliminary cost of this 16" steel pipe system was estimated to be close to \$4 million. In addition, many bridges have very low longitudinal grade, providing little slope to provide the necessary hydraulic gradient. Some bridges have a negative grade when crossing deeper canyons. Bridges with lifts can also pose problems.

Locating BMPs in the touchdown (abutment) area can also be problematic. Space is at a premium and there may be geotechnical concerns with infiltration near the bridge supports or where slopes are steep down gradient. Areas adjacent to bridges often include sensitive riparian and wetland habitat. Areas in natural condition that are neither wetland nor home to threatened and endangered species can be undervalued and lost, even when biodiversity is high. Nevertheless, the use of conventional BMPs in the abutment area has been shown to be protective of receiving water beneficial uses.<sup>40</sup>

### Detailed Discussion of Structural, Physical, and Spatial Constraints

Structural, physical, and spatial constraint issues associated with placing conveyance systems and runoff BMPs on bridges were summarized in *NCHRP Report 474*. Such issues included the following:<sup>41</sup>

- **System Configurations.** Typically, a stormwater conveyance system is comprised of a number of deck inlets each connected to lateral pipe running transversely to the bridge. This lateral pipe conveys deck runoff to a main

trunk line running longitudinally along the length of the bridge. The trunk line exits the bridge at the abutments and connects to a treatment system located nearby. The details of the conveyance will depend on the type of bridge under consideration. Given the large number of bridge types, there will be a wide variety of piping layouts, inlet sizes, and support systems.

- **Bridge Load.** If large diameter piping will be required to convey the stormwater, the additional load to the bridge must be considered early in the bridge design. The AASHTO Bridge Design Specifications do not specifically mention this load; therefore, the designer will need to apply project-specific criteria to evaluate this load in combination with other bridge loads.
- **Inlets.** Although inlets for bridge deck drainage systems are typically much smaller than inlets on roadway drainage systems, they can create substantial conflicts with the structural design of the bridge. The inlet typically is cast into a concrete deck. This creates a conflict with the transverse and longitudinal deck-reinforcing steel; therefore, additional reinforcing may be required in these locations. Large inlets in positive longitudinal bending locations may necessitate analyzing the bridge deck using a reduced section modulus determined by subtracting the portion of the deck lost to the inlet. Decks with posttensioning steel require special consideration. Inlets can create conflicts with both longitudinal and transverse posttensioning. Relocation of longitudinal posttensioning in the field may not be possible. Anchorage zones for transverse posttensioning may be adversely affected because inlets are typically placed at the edge of the deck where the anchorage stresses are highest. These details must be considered at the design stage to avoid construction difficulties. Inlet design must consider the deck grooving and grinding that may be performed on bridge decks. This may necessitate casting the inlet below the top of deck level. Some agencies specify a minimum spacing of 10 feet for inlets.
- **Piping.** The piping for bridge stormwater conveyance is typically much smaller than piping used for roadway drainage systems, in which the minimum pipe diameter is often 18 inches. Bridge deck drainage systems typically incorporate 6-inch-minimum-diameter pipes. Piping is usually located within the structure of the bridge to satisfy vertical clearance requirements. From an aesthetic standpoint, locating the pipes between the girders and thereby hiding them from view is beneficial. Piping is usually located inside of box girder bridges for the same reasons. To reduce clogging, large radius sweeps are used at bends in the piping (3-foot radius bends on 6-inch pipes is common). The designer should verify that sufficient space exists for these sweeps; otherwise the piping will conflict with girders or penetrate below the bridge depth. Because of the sweeps

<sup>40</sup>NCDOT/URS, Stormwater Runoff from Bridges, Final Report to Joint Legislation Transportation Oversight Committee, North Carolina Department of Transportation (2010)

<sup>41</sup>NCHRP Report 474, Vol. 2, pp. 69–70

and the limited headroom available within the bridge, pipe slopes are essentially restricted to the bridge slope. Piping located near the top of vertical curves may have very slight slopes and small flow capacities. Care must be taken to avoid conflicts between the piping and the other utilities on the bridge. For durability and maintenance concerns, the piping must be strong. Welded steel pipe is commonly used. Structural analysis of the piping system is required to verify the pipe supports and to verify that the pipe can span between these supports.

- **Conflicts with Structural Members.** The following structural members can be adversely affected by the conveyance system:
  - Girder Webs. Penetrations in the girder webs are often necessary for the pipe laterals, because the inlets are necessary in complex piping systems and should be made accessible from safe locations. Access to expansion joints is especially important for their maintenance.
  - Maintenance Travelers. On bridges incorporating maintenance travelers, the travelers will have to be designed to access the pipes and not to conflict with them. Coordination is required with compressed air piping to avoid conflicts.
  - Vents on Box Girder Bridges. Vents are provided on box girder bridges to allow air to circulate inside the bridge. Often these vents are only 4 inches in diameter. Designers should resize the vents or provide additional vents to pass the flow of a broken trunk line pipe within the bridge. For large diameter piping, a steel grate, similar to that used on bridges with pressure pipe water utilities, may be necessary.
- **Roadway Design.** Consideration of bridge drainage and conveyance issues during the geometric design of the roadway will lead to simplified conveyance systems. Most importantly, avoiding sag curves and super-elevation reversals on the bridge will greatly reduce the number of inlets and the diameter of piping. Locating the high point of the bridge near the middle of its length may negate the need for inlets and piping on the bridge. Constant width bridges have simpler piping systems than tapered bridges and less likelihood of girder conflicts. All the flow upstream of the bridge should be intercepted to limit bypass flow from entering the bridge and having to be conveyed through the less-reliable bridge conveyance system. Most bridge designs restrict the amount of surface flow that may pass over the expansion joint between the approach slab and the superstructure.
- **Intermediate Diaphragms and Cross-Frames.** The longitudinal trunk line may conflict with these transverse members.
- **Bent Caps.** Integral concrete caps are typically highly reinforced and will have additional steel at the column/cap

joint for joint shear requirements. Because piping often is directed down columns at the bents, the sweeping turns in the piping make this a difficult area to avoid reinforcing. Often the column transverse and main reinforcing are spaced more tightly than the diameter of the piping.

- **Columns.** Pipes conveying stormwater down concrete columns typically exit the face of the column just above the footing. When a fixed connection between the column and the footing exists, the pipe will conflict with the transverse and main longitudinal column steel just as it does at the bent cap. This necessitates additional analysis and detailing.
- **Hinges.** In concrete bridges, hinges in the superstructure are highly reinforced and experience high bending and shear stresses. Large diameter trunk lines are difficult to fit in this area.
- **Expansion Joints.** Bridges with expansion capability at the abutments or in the spans will require compatible pipe expansion joints. These joints are typically of much larger diameter than the connecting pipe and are difficult to maintain. On very large bridges, the joint may be expected to move over 1 foot under temperature movements alone. Designing expansion joints for such large movements is difficult. An alternative to providing a mechanical joint at abutments is to construct a gapped system in which the piping directs stormwater downward from the superstructure into a small rectangular funnel-shaped reservoir located in the abutment seat. In this manner, the piping in the superstructure moves with the expansion or contraction of the bridge above the small receiving reservoir, which is sized to always accept water from the piping.
- **Maintenance.** Bridge stormwater conveyance systems, because of their small diameter piping and the nature of highway debris, create a challenge for maintenance staff. Repairing or replacing damaged or worn piping and components is difficult. This is especially true in enclosed box girder bridges because of restricted access, low working headroom, and low-light conditions. Access hatches or manholes are required in the top or bottom slab of box girder bridges, creating more locations for conflicts with rebar and posttensioning steel. DOTs report that there are other general problems with maintenance of collection systems on bridges. Maintenance “elevated over the ground and adjacent to fast moving traffic” is a safety issue and a “risk to life.”<sup>42</sup> In addition, the lifespan of pipes and systems “generously, is 10-20 years to replace the whole system versus a 50+ year bridge life,”<sup>43</sup> making the issues and problems recurring ones, not just in maintenance, but in construction and finance.

<sup>42</sup> Project interview with NCDOT, USGS, and URS, December 20, 2012

<sup>43</sup> Project interview with NCDOT, USGS, and URS, December 20, 2012

- **Limitation in Right-of-Way.** There is no flexibility regarding the size of the foot print. There is no lateral right-of-way on which to build mitigation measures. Mitigation measures can be located on the bridge only at substantial cost, or stormwater must be gravity drained back to land.

## Other Perceived Conveyance System Challenges from DOT Practitioners

### *Unexpected Environmental Impacts from Conveyance System Design*

In addition to a larger carbon and physical footprint when bridges have to be expanded to accommodate spread from curbside stormwater runoff, and impacts on subaquatic vegetation, treatment areas sometimes encounter unexpected problems. For example, in North Carolina, a long coastal bridge (Virginia Dare Bridge) discharges to shellfish waters. NCDOT put in collection systems over the wetlands, to discharge into filtration basins; however, NCDOT found that the bacterial concentrations they were trying to prevent rose in the collection system because the warm water along with presence of trash and debris attracted animals that routinely produced waste.<sup>44</sup>

Additionally, two DOTs noted cases in which they had widened a bridge deck in order to transport stormwater off the bridge without it spreading into the travel lane, when runoff could not be drained through scuppers. Undoubtedly, wider design concepts necessitate higher construction cost. NCDOT estimated the additional cost at around \$120 per square foot.<sup>45</sup> Other agencies, such as MassDOT, doubted that regulators would agree to a wider bridge as an answer, despite the potential that additional shaded area beneath the structure would lessen the impact to regulated resources.<sup>46</sup>

### *Conflicts of Conveyance System Design with Stakeholder Interests and Public Aesthetics*

States on both coasts raised the high public expectations for DOTs to deliver aesthetically pleasing bridges. Maryland's Chief of Hydraulics explained that on one of the bridges where they discussed having a collection system instead of scuppers, MDSHA proposed running the pipe in a box girder and devised a collection system maintenance approach. However, concerns were raised from the local boating community about the aesthetics of the design and the potential

<sup>44</sup>Project interview with Karuna Pujara, Chief of Hydraulics, Maryland State Highway Administration (MDSHA) December 20, 2012

<sup>45</sup>URS/NCDOT 2010, Chapter 7. 7-9, note G

<sup>46</sup>Project interview with Alex Murray and Henry Barbaro, Massachusetts DOT (MassDOT), December 2012

for discharge of bird excrement.<sup>47</sup> Thus, if MDSHA implemented the piped collection approach, they could possibly achieve nutrient reduction, but in the process, add pathogens. Ultimately, piping was eliminated because it was concluded that the benefits did not outweigh the costs.<sup>48</sup> In this case, MDSHA used a lip that allowed water to run off the deck to treat the first flush and the agency made the shoulders bigger to handle the spread. Consequently, transportation capacity was reduced<sup>49</sup>

## Bridge Deck Runoff Mitigation Strategies

Safety and other reasons require prompt removal of water from travel lanes on bridges. Thus, public safety concerns have dominated the discussion on drainage or runoff management until more recently. This section reviews how structural treatment BMPs and operational source control practices are typically incorporated into runoff mitigation strategies. DOTs tend to focus on the approaches to the bridge if on-site stormwater treatment is included or added to a project. While older bridges tend to drain untreated through the deck or scuppers, runoff from newer bridges that drain to sensitive waters or priority areas may be treated.

### Use of Structural Treatment Controls on Bridges

#### Considerations and Limitations to Treatment Identified by DOTs

In the interviews for NCHRP Project 25-42, DOTs identified the following considerations related to runoff mitigation strategies:

- **Resource Agency Requirements/Specifications.** Nearly every DOT interviewed said that the difficulties with on-bridge modifications are such that bridge runoff tends only to be treated if resource agencies specifically require it. For example, the Nebraska Department of Roads (NDOR) will treat bridge runoff "when it is requested by Game & Parks/Fish and Wildlife Service through project coordination."<sup>50</sup> Likewise, the Louisiana Department of Transporta-

<sup>47</sup>Project interview with Karuna Pujara, Chief of Hydraulics, Maryland State Highway Administration (MDSHA) December 20, 2012

<sup>48</sup>Project interview with Karuna Pujara, Chief of Hydraulics, Maryland State Highway Administration (MDSHA) December 20, 2012

<sup>49</sup>Project interview with Karuna Pujara, Chief of Hydraulics, Maryland State Highway Administration (MDSHA) December 20, 2012

<sup>50</sup>Personal communication with Gabe Robertson, Nebraska Department of Roads, December 17, 2012

tion Development (LADOTD) treats runoff “in accordance with permit.”<sup>51</sup> TxDOT also said it treats bridge deck runoff only if there is a regulatory requirement to do so; “typically, this is tied to 401 certification of very large Individual 404 permits (more than 1,000 linear feet or 3 acres of impact to waters of the US), a rare event.”<sup>52</sup> In North Carolina, the decision to treat is based on specific considerations like water quality classifications of the waters to which the bridge discharges, any ESA issues, and whether the bridge is being newly constructed. Other regulations with which NCDOT must comply and which potentially drive treatment include the Clean Water Act 401 certifications, the NPDES program, state stormwater program, and state regulations on nutrient sensitive waters, covering one-third of the state. For new bridges, state water quality agencies issue a 401 certification and have greater authority than on retrofit projects. Other DOTs (e.g., LADOTD, MassDOT) had no special or additional designs beyond the standard HEC 21 guidelines or the state’s stormwater handbook. States emphasized that designs were developed on a site-by-site basis as a result of requirements emerging in the environmental scoping process and what was considered the MEP treatment for the site. MDSHA also does “nothing different for bridges.”<sup>53</sup> As previously discussed, in one case, MDSHA raised the lip height of scuppers to avoid direct discharge of the first flush. In other places MDSHA decided not to put in any scuppers if the bridge is small enough. DOTs may treat bridge deck runoff to the Maximum Extent Practicable (MEP), “just like roadway runoff,” but “options for bridge deck runoff are few” and “success in piping” is more possible on shorter spans, according to MassDOT.<sup>54</sup> Thus, MEP is different for bridges than conventional roadway sections. MDSHA has also added BMPs at bridge approaches, since runoff is generally untreated in these areas. MDSHA has had the arrangement that “if the bridge surface is one acre, MDSHA needs to find one acre of approach roadway runoff to manage.”<sup>55</sup> Managing runoff along the deck is generally considered the main design challenge.

- **Highly Sensitive Areas.** Treatment of bridge deck runoff tends to be confined to highly sensitive areas. For example, LADOTD is transporting and treating runoff from only one (1) bridge site at this time, a case in which a bridge crosses a sensitive water body and drinking water supply.<sup>56</sup>

TxDOT and MassDOT also referenced the importance of drinking water supplies and treatment in those areas.<sup>57</sup>

- **Bridge Girder Size and the Pipes that Can Be Accommodated.** If they have to, some DOTs (e.g., FDOT, WSDOT) will pipe stormwater off bridge decks; however, girder size constrains the size of the pipes that can be used under them. For example, due to girder sizes in Washington State, “pipes have to go back and forth through the girders underneath the bridge and the pipe size is constrained,” preventing diversion of more than 91% of the 2-year storm in the sample case provided.<sup>58</sup>
- **Spread and Bridge Elevation.** If DOTs can get the water to the end of the bridge and a space where it can be sustainably treated, they will do so;<sup>59</sup> however, if water spreads into the travel lane, it increases hydroplaning potential and risk of accidents. “On long flat bridges, the spread tends to open up very quickly and the DOT can’t always get the stormwater to the ends of the bridge.”<sup>60</sup>
  - **Gutters:** Some DOTs say they have been successfully using a gutter system, draining to detention areas or vegetative swales for treatment. Other research in North Carolina suggested that gutters might be implicated in concentration of pollutants.<sup>61</sup>
  - **Source Control like High Efficiency Sweeping:** On some of the newer bridges where the DOT cannot get stormwater off the bridge and into treatment (e.g., WSDOT’s new floating bridge, which is very flat), the DOT is using source controls like high efficiency sweeping.<sup>62</sup>
- **Ability to Perform Treatment on Roadsides along Bridge Approaches.** Treatment at bridge approaches may include detention ponds, grass swales, or buffers, but treatment at bridge approaches is not always feasible. For example, MDSHA is treating bridge deck runoff to comply with state and federal requirements, in their case relating to impervious surfaces, but treatment near the bridge approach is infeasible in certain areas due to the 100-year floodplain and wetland regulation.<sup>63</sup> In low-lying coastal areas, the

<sup>51</sup> Project interview with Joubert Harris, LADOTD, January 3, 2013

<sup>52</sup> Personal communication with Amy Foster, TxDOT, December 2012

<sup>53</sup> Project interview with Karuna Pujara, Chief of Hydraulics, Maryland State Highway Administration (MDSHA) December 20, 2012

<sup>54</sup> Project interview with Alex Murray and Henry Barbaro, Massachusetts DOT (MassDOT), December 2012

<sup>55</sup> Project interview with Karuna Pujara, Chief of Hydraulics, Maryland State Highway Administration (MDSHA) December 20, 2012

<sup>56</sup> Project interview with Joubert Harris, LADOTD, January 3, 2013

<sup>57</sup> Project interview with Alex Murray and Henry Barbaro, Massachusetts DOT (MassDOT), December 2012. Also, personal communication with Amy Foster, TxDOT, December 18, 2012

<sup>58</sup> Project interview with Mark Maurer, PLA, PE, Highway Runoff Program Manager, Washington State Department of Transportation, December 18, 2012, Project interview with Amy Tootle and Rich Renna, Florida DOT, December 18, 2012

<sup>59</sup> Project interview with Amy Tootle and Rich Renna, Florida DOT, December 18, 2012

<sup>60</sup> Project interview with Amy Tootle and Rich Renna, Florida DOT, December 18, 2012

<sup>61</sup> Jy S. Wu and Craig J. Allen, Sampling and Testing of Stormwater Runoff from North Carolina Highways, 2001

<sup>62</sup> Project interview with Mark Maurer, PLA, PE, Highway Runoff Program Manager, Washington State Department of Transportation, December 18, 2012, Project interview with Amy Tootle and Rich Renna, Florida DOT, December 18, 2012

<sup>63</sup> Project interview with Karuna Pujara, Chief of Hydraulics, Maryland State Highway Administration (MDSHA) December 20, 2012



floodplain may be wide and wetlands extensive compared to the bridge project, in addition to the difficulties with draining water on long, flat bridges. Such cases are drivers in considering off-site mitigation. Stream buffer regulations can also restrict a DOT's ability to treat stormwater at bridge approaches. NCDOT cited instances of buffer regulations where NCDOT "can't discharge into Zone 1 (30 feet) and in some cases Zone 2."<sup>64</sup> Only two state DOTs interviewed (WSDOT and SCDOT) said they were treating bridge deck runoff in a vault on a site. WSDOT said they had a bridge (Riverton, WA) where they were using infiltration vaults to treat and infiltrate water off the bridge.

- In a case over a shellfish area and outstanding resource water (ORW), SCDOT has a closed system and Stormceptor® device treating drainage from one direction (the other could be piped to an upland detention site); however, SCDOT said the closed system approach, "isn't very practical. Stormceptors® don't do much to treat fecal coliform and might even exacerbate it. Sometimes rodents get in closed systems and make water quality worse."
- **Availability of Off-site Mitigation.** Consideration of off-site mitigation options is becoming a standard part of the process in Florida and Maryland. South Carolina is "trying to work out something based on surface area of the bridge."<sup>65</sup>
  - MDSHA and the Maryland Department of Environment established a water quality bank that allows for permitting highway projects that cannot meet all stormwater water quality requirements. The water quality credit is established through off-site mitigation at the 6-digit HUC watershed level and the currency is acres of impervious surface treated. The positive balance in the bank is kept by implementation of various water quality projects designed to treat unmanaged impervious surfaces.
  - FDOT tries to partner with co-permittees and "pay for offsite improvements."<sup>66</sup> FDOT is taking advantage of the current political environment to press for off-site treatment; last year, the state legislature passed a bill mandating that the state regulatory community allow flexible treatment approaches for transportation. That bill specifically named watershed level treatment and other strategies. Ultimately, FDOT expects that there will be stormwater banks just like mitigation banks.

- **Modeling to Show That Bridge Doesn't Have Enough Surface Area and ADT to Have Detrimental Effects.** South Carolina DOT is performing modeling to understand the impacts of bridge deck runoff,<sup>67</sup> as is TxDOT. TxDOT has an ongoing project called "Contribution of Bridge Dwelling Birds to Bacterial Water Quality Impairments," for which data is not available yet.<sup>68</sup> TxDOT also sponsored a study called "Characterization of Stormwater Runoff from a Bridge Deck and Approach Highway: Effects on Receiving Water Quality" in 2006.
- **Cost and Technology Development** are factors in generating on-bridge treatment solutions. FDOT is exploring further technology development, in particular bioactivated media, but the technology has not developed to the point of availability for use in bridge scuppers. The University of Central Florida is currently testing seven different medias, trying to achieve 1 gallon, per minute, per square foot loading through the media, which would enable the size to be reduced by about four times from where it is now. The technology has been licensed and is in use in Florida, Michigan, and New Jersey, in up flow baffle boxes as a pre-treatment system, the bottom of retention ponds, bioswales, bio-retention areas, and improving water coming out of wet detention facilities, with favorable cost factors. Filter media cartridges currently developed last about 5 years, but without a cartridge, with more room and four times the material, life expectancy is 20 years.<sup>69</sup> Further products are expected by May 2014 and Florida DOT is highly optimistic.<sup>70</sup>
- **Understanding Resource Agency needs and where Treatment is Really Necessary.** The NDOR mentioned the need for programmatic identification of critical areas, where treatment of runoff might really be necessary. If we, "understand when agencies will require treatment of bridge deck runoff, we can be more proactive in design," said staff at NDOR.<sup>71</sup> Despite the barriers discussed above, some DOTs said they were not encountering issues as they "only have to treat in very exceptional cases, such as over a public water supply (very uncommon) or if there is a regulatory requirement to do so. Typically, this is tied to 401 certification of very large Individual 404 permits (more than 1,000 linear feet or 3 acres of impact to waters of the United States). This doesn't happen very often."<sup>72</sup>

<sup>67</sup> Project interview with Sean Connolly, South Carolina Department of Transportation, January 2013

<sup>68</sup> Personal communication with Amy Foster, TxDOT, December 2012

<sup>69</sup> Personal communication, Dr. Martin P. Wanielista, P. E., University of Central Florida, Orlando, Florida, January 31, 2012

<sup>70</sup> Project interview with Amy Tootle and Rick Renna, Florida DOT, December 2012

<sup>71</sup> Personal communication with Gabe Robertson, Nebraska Department of Roads, December 17, 2012

<sup>72</sup> Personal communication, Amy Foster, Texas DOT, December 18, 2012

<sup>64</sup> Project interview with Matt Lauffer and Kathy Herring, NCDOT, and Michelle Mayfield, Alex Nice (URS Corp), and Chad Wagner, USGS, December 20, 2012

<sup>65</sup> Project interview with Sean Connolly, January 9, 2012

<sup>66</sup> Project interview with Amy Tootle and Rich Renna, Florida DOT, December 2012

Nearly all DOTs contacted said that treatment for new construction projects is determined on a project-by-project basis with resource and regulatory agencies as part of the project planning phase. Where states consider retrofit measures, those may be selected and designed through the DOT's Highway Stormwater Retrofit Program to meet site-specific water quality goals.<sup>73</sup>

NCDOT avoids direct discharge off bridge decks whenever possible; they try to discharge to the overbank and collect and convey the stormwater to the stream in a manner that doesn't cause erosion. On lower ADT secondary bridges, NCDOT is replacing the structures if needed and not adding stormwater treatment mechanisms.<sup>74</sup> Level spreaders and energy dissipaters in the overbank area are the most common method to treat stormwater.<sup>75</sup> Higher-level treatment is provided in consultation with regulatory agencies.<sup>76</sup>

Nearly all of the DOTs contacted are dealing with bridge deck runoff on what they called a "case by case basis." Treatment of bridge deck runoff is far from standard, due to the obstacles treatment entails and the relative benefit that treatment can produce.

### Unique Constraints Associated with Bridge Retrofit

Nearly all interviewed DOTs note that retrofit of water quality devices on a bridge is difficult. MDSHA has figured out a workable approach, swapping untreated bridge deck area for treatment of other currently untreated roadway. The state is also exploring off-site/off-alignment mitigation approaches. LADOTD said, "Funding and budgetary strategies are the bigger challenges. Priority is usually given to new construction and routine retrofit/rehabilitation projects." FDOT is trying to deal with the issue by partnering with co-permittees and "pay in lieu fees."<sup>77</sup> FDOT is focusing on off-site treatment; last year, the state legislature passed a bill mandating that the state regulatory community allow flexible treatment approaches for transportation. That bill specifically named watershed level treatment and other strategies. Ultimately, FDOT expects that there will be stormwater banks just like mitigation banks.

<sup>73</sup>NCDOT, Stormwater Manual, 2008

<sup>74</sup>Project interview with Matt Lauffer and Kathy Herring, NCDOT, and Michelle Mayfield, Alex Nice (URS Corp), and Chad Wagner, USGS, December 20, 2012

<sup>75</sup>Project interview with Matt Lauffer and Kathy Herring, NCDOT, and Michelle Mayfield, Alex Nice (URS Corp), and Chad Wagner, USGS, December 20, 2012

<sup>76</sup>Project interview with Matt Lauffer and Kathy Herring, NCDOT, and Michelle Mayfield, Alex Nice (URS Corp), and Chad Wagner, USGS, December 20, 2012

<sup>77</sup>Project interview with Amy Tootle and Rick Renna, Florida DOT, December 2012

## Common Pollutant Removal Mechanisms Treatment BMPs

*NCHRP Report 565: Evaluation of Best Management Practices for Highway Runoff Control* (2006) describes some of the most common pollutant removal mechanisms for roadway runoff, which apply to runoff from bridges as well, especially where runoff can be routed for treatment off-site:<sup>78</sup>

- **Sedimentation**—Runoff is detained in a basin so that suspended solids and particulate-bound pollutants settle as a function of particle density, particle size, and fluid viscosity (under quiescent conditions) to the bottom of the water column.
- **Filtration and Infiltration**—Runoff passes through an engineered media or existing soils where solids and particulate-bound pollutants are physically filtered by the media. If the media has adsorptive properties, dissolved pollutants may be entrained by the media as well. Treated runoff recharges groundwater supplies and reduces volumes delivered to receiving streams as surface flow.
- **Microbially Mediated Transformations**—Runoff is contained in a microbially diverse environment (e.g., a stormwater wetland, vegetated basin). Microbes decompose and mineralize organic pollutants and transform inorganic pollutants before runoff is released.
- **Sorption**—Runoff is contained in BMP systems (e.g., swales, filtration basins, stormwater wetlands) where substances of one state are incorporated into another substance (absorption) or molecules are bonded onto the surface of another molecule (adsorption).
- **Uptake and Storage**—Organic and inorganic constituents are removed from runoff by plants and microbes through nutrient uptake and bioaccumulation.

## Source Control Approaches for Bridges

### General Discussion

Non-structural BMPs are often used as source control and management methods. Source control measures can be cost-effective and sometimes more efficient pollutant mitigation compared to treatment control practices. Alternative pavements, street sweeping, catch basin and scupper cleaning, deck drain cleaning, deicing controls, traffic management, management of hazardous materials, and spill prevention can be implemented without any structural burden on the bridge.

<sup>78</sup>Oregon State University, Geosyntec, et al., *NCHRP Report 565, Evaluation of Best Management Practices for Highway Runoff Control* (2006), cited in NCDOT, p. 2-10

Some DOTs confine source control to DOT operations only. For example, during construction and maintenance projects, LADOTD limits materials placed on bridges to only that necessary, with special attention to cleaning materials, solvents and/or fuels. Only non-phosphate solutions are allowed for cleaning bridge structures. During deicing events, minimum amounts of deicing agents are used. MassDOT no longer uses sand for low traction conditions, and many DOTs have dramatically reduced sand usage, for both air and water quality purposes.

Other DOTs are contemplating how passing vehicle sources could be better controlled, outside of reducing vehicle spray through greater use of PFC/OGFC. For example, NCDOT leaders would like to see how rumble strips prior to the bridge could shake off pollutants from the undercarriage of vehicles, to minimize pollutants being carried onto bridges and subsequently falling on bridges or being sprayed off splash, during precipitation events. Engineers have noticed concentrations of oil and grease where there are irregularities in the roadway surface.<sup>79</sup> Nearby on-site BMPs could be used to treat runoff from these areas.

### **Alternative Pavements—Permeable Friction Course and/or Open Graded Friction Course (OGFC) Pavement**

PFC/OGFC may act as a source control for pollutants on the undercarriage and exterior of vehicles by greatly reducing the spray that occurs during precipitation events, and entrapment of particles within the overlay matrix. TxDOT and NCDOT have invested in research on the water quality benefits of PFC and/or OGFC pavement. Eck et al. and data from North Carolina indicated that the water quality benefits last as long as the structural life of the pavement, even though no maintenance at all was performed.<sup>80</sup> NCDOT confirmed that as long as the road has speeds over 45 mph, pavement maintenance can be avoided without a loss of permeability in the overlay. NCDOT has one more PFC research project underway.<sup>81</sup> WSDOT said they would consider OGFC on the wearing course but OGFC is susceptible to damage from studded tires.

OGFC is being used and considered for use on roadway shoulders and for water quality treatment purposes, even where it is not used on the wearing course. NCHRP 25-25/82 will provide design guidance for permeable pavements on roadway shoulders.<sup>82</sup>

<sup>79</sup> Project interview with Matt Lauffer and Kathy Herring, NCDOT, and Michelle Mayfield, Alex Nice (URS Corp), and Chad Wagner, USGS, December 20, 2012

<sup>80</sup> Eck, Bradley, et al. Water Quality of Drainage from Permeable Friction Course, *Journal of Environmental Engineering, ASCE*, February 2012, pp. 174

<sup>81</sup> Project interview with Matt Lauffer and Kathy Herring, NCDOT, and Michelle Mayfield, Alex Nice (URS Corp), and Chad Wagner, USGS, December 20, 2012

<sup>82</sup> Project interview with Mark Maurer, PLA, PE, Highway Runoff Program Manager Washington State Department of Transportation, December 18, 2012

### **Street Sweeping**

Street sweeping is one of the most common source control approaches in MS4s and some states are considering applying this measure outside of MS4s, where sufficient bridge height for flow to bridge ends is lacking. The water quality benefit of sweeping is somewhat controversial though. Schilling (2005) indicates that the direct benefit to stormwater quality or effect on receiving waters of this sediment removal has not been conclusively defined.<sup>83</sup> NCDOT's 2010 report states that:<sup>84</sup>

Additional investigation is needed to establish the effectiveness of bridge sweeping as a BMP (BMP for stormwater) and to provide potential improvements to existing sweeping practices to benefit stormwater quality. NCDOT conducts sweeping practices for many existing bridges throughout the state because of the associated maintenance and safety benefits . . . NCDOT does not currently conduct bridge sweeping to specifically address stormwater quality concerns; . . . (however), because of the potential to remove large amounts of sediment, bridge sweeping should continue to be considered as a potential water quality Level II treatment BMP for bridge decks.

Multiple DOTs are looking at bridge sweeping as a viable alternative for stormwater mitigation, particularly when other methods of treatment are not feasible or are cost-prohibitive, which may be the case for long coastal bridges. In addition, potential improvements to existing sweeping practices should be considered, including equipment upgrades and new training for proper disposal of captured solids. Additional study is recommended to further evaluate sweeping as a BMP and to shape sweeping practices (including frequency, type of equipment, and disposal practices) to maximize the benefit for stormwater quality (NCDOT 2010).

NCDOT has used sweeping as a negotiated stormwater control measure. On Currituck Bridge, it was not possible to install a collection system for technical reasons. Sweeping was agreed to as a source control measure with the regulatory agency, with the PPP managing the bridge for 50 years. Sweeping will be performed on a 7-day rotation during the summer, after the peak traffic period, by the private operating company.

Other state transportation agencies, such as MDSHA, are trying to determine how they can squeeze the requested sweeping cycles (25 in MDSHA's case) in during the non-freeze/summer months.<sup>85</sup> The anti-icing material is needed on the

<sup>83</sup> Schilling, 2005

<sup>84</sup> NCDOT, URS, Stormwater Runoff from Bridges, Final Report to Joint Legislation Transportation Oversight Committee, North Carolina Department of Transportation (2010), p. 8-2

<sup>85</sup> Project interview with Russ Yurek, MDSHA Maintenance Manager, May 31, 2012



roadway November–April (when rain might freeze), so sweeping during those seasons is counterproductive. Thus, the agency would be “sweeping every week in the summer, and MDSHA would like to validate this interval,” so the agency is “working through the issue internally; they want to make sure they manage this process well as a public agency.”<sup>86</sup>

MDSHA needs to report the pounds of sediment collected by sweeping, which can be difficult for contractual processes going from one county line to another but crossing several watershed boundaries, before weighing and disposing. MDSHA’s Chief of Hydraulics posed several questions and comments: Do they stop the truck from watershed boundary to watershed boundary and go weigh? Do they pro-rate it? MDSHA supports highway sweeping but perhaps at a frequency of 2-3 times per year, an order of magnitude difference than what the regulatory agency would like to see.<sup>87</sup>

MDSHA is also concerned that they cannot sweep from one watershed to another, meaning the DOT might be able to sweep only a portion of the drainage area in downtown Gaithersburg, contravening expectations that the DOT would sweep an entire stretch of road, such as Main Street. MDSHA is unsure whether they can physically do this type of sweeping at an economical level, in a way that is fair to the public. The fairness/justice issue and public expectations are very important because sweeping is a very visible DOT activity that “builds expectation because the public sees this occurring every two weeks.”<sup>88</sup>

There are a number of ways that sweeping may be applied at a DOT. Where sweeping is found to be practical and beneficial to deal with particulates, new high-efficiency street sweeping machines may be economical in urbanized areas<sup>89</sup> and for some bridges that lack the vertical drop needed for drainage to bridge approaches. Other DOTs, such as FDOT, noted that sweeping was usually done by co-permittees. SCDOT utilizes a compliance matrix/checklist to identify where source controls apply. The evaluation is based on the amount of development in the watershed (e.g., above 5% impervious surface/development) and how much DOT right-of-way is in that watershed.<sup>90</sup> If the agency is over a certain percentage, they must perform sweeping and checks for (and removal of) dead animals.<sup>91</sup>

<sup>86</sup> Project interview with Karuna Pujara, MDSHA Chief of Hydraulics, December 20, 2012

<sup>87</sup> Project interview with Karuna Pujara, MDSHA Chief of Hydraulics, December 20, 2012

<sup>88</sup> Project interview with Karuna Pujara, MDSHA Chief of Hydraulics, December 20, 2012

<sup>89</sup> Perkins, R., and Hazirbaba, Y., Alaska UTC and DOT & Public Facilities, Bridge Deck Runoff: Water Quality Analysis and BMP Effectiveness, December 2010, p.2

<sup>90</sup> Project interview with Mark Giffin, Project Manager, South Carolina Department of Health and Environmental Conservation, January 7, 2013

<sup>91</sup> Project interview with Mark Giffin, Project Manager, South Carolina Department of Health and Environmental Conservation, January 7, 2013

### *Improved Sweeping Technology and Planning:*<sup>92</sup>

- **New vacuum-assisted and regenerative air sweepers** (which blow air onto the pavement and immediately vacuum it back to entrain and filter out accumulated solids) have greatly increased effectiveness, particularly with fine particles. In terms of improved sweeping methods, tandem sweeping, which is mechanical sweeping followed immediately by a vacuum-assisted machine have shown good increases in percent pollutant reductions (Sutherland and Jelen 1997).
- **Broom/vacuum combination.** In recent studies, a new type of street-sweeping machine called the EnviroWhirl was found to be most effective, reducing TSS loading up to 90% for residential streets and up to 80% for major arterials. The actual percent reduction also depended on the number of cleanings per year, with the maximum reduction reported for weekly cleanings. Results for biweekly cleanings are about 70% for both residential and major arterials.

### **Deicing Controls**

Reduced salt usage is one of the most profound source control actions a DOT can take. For example, Caltrans implemented a reduced salt-use policy starting in October 1989 that required transportation districts to develop specific route-by-route plans.<sup>93</sup> That policy stated that, “Snow removal and ice control should be performed as necessary in order to facilitate the movement and safety of public traffic and should be done in accordance with the best management practices outlined herein with particular emphasis given to environmentally sensitive areas.”<sup>94</sup> During the first winter, Caltrans reduced salt usage by 62% statewide as compared to the previous winter, helped by improved control of the application frequency of deicing salt.<sup>95</sup>

Alternative deicing practices and compounds that can reduce the loading include using alternative deicing compounds (e.g., calcium chloride or calcium magnesium acetate), designating “low salt” areas on bridges over sensitive receiving waters, and reducing deicing applications through operator education, training, and equipment calibration. In addition, using deicers such as glycol, urea or calcium

<sup>92</sup> NCDOT/URS, Stormwater Runoff from Bridges, Final Report to Joint Legislation Transportation Oversight Committee, North Carolina Department of Transportation (2010), p. 32

<sup>93</sup> Venner, Marie, NCHRP 25-25/04: AASHTO Compendium of Environmental Stewardship Practices, Policies, and Procedures, 2004

<sup>94</sup> California Department of Transportation, “The Use of Deicing Chemicals on California State Highways.” Caltrans Report to the Legislature in response to Chapter 318. (July, 1992), cited in Venner/AASHTO, 2004

<sup>95</sup> California Department of Transportation, “Caltrans Snow and Ice Control Operations.” (March, 1999) 7 pp., [www.dot.ca.gov/hq/roadinfo/snvicecontrol.pdf](http://www.dot.ca.gov/hq/roadinfo/snvicecontrol.pdf), cited in Venner/AASHTO, 2004



magnesium acetate (CMA) reduces the corrosion of metal bridge supports that can occur when salt is used. There are no effective methods for removing salt from stormwater, which points toward source control as the only viable alternative for mitigation.<sup>96</sup>

“Smart” in-vehicle application technology involving GPS and electronic sensing might make it feasible to use special deicers on bridges, or not use them at all, depending on the circumstances.<sup>97</sup>

### DOT Strategies for Handling Hazardous Material Contamination from Bridges

The survey of state DOTs performed for *NCHRP Report 474* found that the instances where treatment of bridge deck runoff was required involved drinking water supplies, crossing ORWs or national recreation areas, and/or concerns over endangered species or hazardous material spills.<sup>98</sup>

#### Spills

Every DOT has a process in place for handling hazardous material spills. Most of these were focused on first responder protocols and on promptly containing and controlling the spill after the fact. Sometimes the DOT puts in a retention swale; a 20-foot long structure could include weirs and skimmers. Florida DOT has instances of a skimmer collecting an entire gas spill.<sup>99</sup>

Several DOTs noted that “there are so many sensitive receptors out there (fish, wetland, water supplies)” that the DOT has placed a priority on water supplies.<sup>100</sup> In the northeast, considerable land is reserved to protect water supplies. Instead of installing valves or boxes, MassDOT has detention areas and first responders have spill kits of plugs, caps, and booms; the focus is on getting first responders out there in a timely fashion.<sup>101</sup> To facilitate this, MassDOT helped develop a hazmat response storm drain Atlas that shows every segment of highway with outfalls and catch basins:<sup>102</sup>

<sup>96</sup> Talend, D., Salt: No Easy Answers. Stormwater, the Journal for Surface Water Quality Professionals 10 (7): 2009, pp. 16–28

<sup>97</sup> Perkins, R., and Hazirbaba, Y., Alaska UTC and DOT & Public Facilities, Bridge Deck Runoff: Water Quality Analysis and BMP Effectiveness, December 2010, p. 2

<sup>98</sup> Dupuis, T., National Cooperative Highway Research Program (NCHRP) Report 474: Assessing the Impacts of Bridge Deck Runoff Contaminants in Receiving Waters, Volume 1 Final Report (2002), pp. 24–25

<sup>99</sup> Project interview with Rick Renna, Florida Department of Transportation, December 2012

<sup>100</sup> Project interview with Alex Murray and Henry Barbaro, Massachusetts DOT (MassDOT), December 2012

<sup>101</sup> Project interview with Alex Murray and Henry Barbaro, Massachusetts DOT (MassDOT), December 2012

<sup>102</sup> Project interview with Alex Murray and Henry Barbaro, Massachusetts DOT (MassDOT), December 2012

Instead of building a mechanical system that may fail, the first responders identify where the spill is going to discharge from the storm drain system Atlas and deploy caps, covers and plugs are used to try to contain the spill. There are some outfalls where the highway serves as the embankment of the reservoir. The DOT has catch basin hoods and deep sumps in these areas for containment.

DOTs also maximize the use of swales. DOTs referenced the following practices to reduce the risk of contamination from spills off bridge decks:

- MassDOT has tried to reduce risk by improving roadway geometry and site distance where applicable. In general, “If the road is straight, MassDOT would do nothing in particular. If the receiving water was an essential water supply or critical in some way or there is higher probability of a spill the location will receive higher priority.”<sup>103</sup>
- WSDOT also relies on absorbent booms that would be put around scuppers or drains, to prevent water contamination. In some cases, spills have been directed to a wetland that could be cleaned up before contamination of the lake.<sup>104</sup>
- MDSHA noted that in one particular watershed they installed shut off valves on a riser structure so they could isolate the pond from the drainage system.
- NCDOT has a policy on hazardous spills and Chapter 9 of their BMP toolbox addresses hazmat considerations.
- NDOT noted that spills are documented through NDOR’s DIRK (Department Incident Reporting knowledgebase) system.
- NCDOT installed a hazardous spill basin on Highway 64 in line with the flue gate. Special consideration has been strongly encouraged but not required, for mussels, often listed as threatened or endangered.

### Bridge Painting and Washing Practices

As noted in *NCHRP Report 474*, bridge painting is probably the most common bridge maintenance practice and the one with potentially the greatest adverse effects on the receiving water.<sup>105</sup> Blasting abrasives and paint chips from painting activities may fall into the receiving waters below the bridge. Surveys have indicated that up to 80% of the bridges repainted each year were previously painted with lead paint. These surveys have also indicated that substantial amounts of

<sup>103</sup> Project interview with Alex Murray and Henry Barbaro, Massachusetts DOT (MassDOT), December 2012

<sup>104</sup> Project interview with Mark Maurer, PLA, PE, Highway Runoff Program Manager, December 2012

<sup>105</sup> Dupuis, T., National Cooperative Highway Research Program (NCHRP) Report 474: Assessing the Impacts of Bridge Deck Runoff Contaminants in Receiving Waters, Volume 1 Final Report (2002)

used abrasives can be lost to the environment if appropriate containment practices are not used.<sup>106</sup>

Paint overspray and solvents also may be toxic to aquatic life if they reach the receiving water (Kramme 1985). An AASHTO Center for Environmental Excellence consulting engagement on environmental maintenance practices for the Kentucky Transportation Cabinet and AASHTO's Environmental Stewardship Practices Guide describe bridge painting and washing practices to avoid and minimize environmental contamination, in particular, impacts to water quality.<sup>107</sup> Young et al. estimated that the costs of implementing measures to reduce the effects of bridge painting on receiving water quality are an additional 10 to 20% for containment techniques and an additional 10 to 15% for waste disposal,<sup>108</sup> both of which are accepted practices now.<sup>109</sup>

Bridge wash water also generally needs to be tested and/or treated before being either discharged to the receiving water or otherwise controlled and managed off-site (NCHRP 2002). Recovery of wastes, containment of wastes, and training of maintenance workers to increase their awareness of potential impacts on receiving waters are techniques that can be used to decrease the impacts of bridge maintenance activities on receiving waters.<sup>110</sup>

## Endangered Species Act Implications

The ESA is a driver with treatment of bridge deck runoff in the Northwest, where salmonids are a consideration. At WSDOT, "most of WSDOT's bridge deck treatment is driven by ESA. They have different triggers in the Highway Runoff Manual, which outlines the minimum."<sup>111</sup> The Highway Runoff Manual, the ESA Section 7 biological assessment or biological opinion or the state CWA 401 certification may outline extra requirements in sensitive areas. Sometimes, WSDOT will, "go someplace else to do equivalent area treat-

ment; sometimes it is just too difficult to get the water off the bridge."<sup>112</sup>

In the southeast, mussels are a consideration. NCDOT reported that the ESA has driven treatment of bridge deck runoff in the western part of North Carolina. The South Carolina DOT said the Carolina Heelsplitter (a mussel) has been an issue during construction but not post-construction. Generally, SCDOT, "complies with Corps requirements."<sup>113</sup> LADOTD noted that any ESA issues that arise in project development would lead to a special request that would then be accommodated by Hydraulic Design. This is consistent with other DOTs processes. Florida DOT said they have installed Manatee grates at outfalls but it is not influencing treatment of bridge deck runoff.

The box turtle has triggered bridge deck runoff requirements in Maryland. Threatened and endangered species are less of a factor in the northeast, where states recalled no known instances where the ESA drove treatment of bridge deck runoff. NDOR reported that, "the ESA seems to be the driver in requiring treatment of bridge deck runoff"<sup>114</sup> in the Midwest as well. Texas studies have often occurred in the same area as the Barton Springs salamander, an ESA-listed species. TxDOT has installed PFC to help address water quality and threatened and endangered species in sensitive areas.

## Other Miscellaneous Source Control Methods and Operation Control Measures on Bridges

DOTs have shared a number of other source control practices including the following:<sup>115</sup>

- **High efficiency catch basin cleaning** is being considered along with high efficiency sweeping in some states.<sup>116</sup> NCDOT is exploring design-related stormwater control measures for bridge decks such as creating guidance on bridge materials that can reduce the concentration or load of pollutants in runoff that enters receiving streams.
- **Coatings for exposed galvanized metals.** Bridge deck runoff studies in Texas found that exposed galvanized metal

<sup>106</sup>Young, G. K., Stein, S., Cole, P., Kammer, T., Graziano, F., and Bank, F., "Evaluation and Management of Highway Runoff Water Quality." Publication No. FHWA-PD-96-032 (June 1996)

<sup>107</sup>Venner and Kober, 2002, AASHTO CEE consulting engagement for the Kentucky Transportation Cabinet, Bridge Washing and Painting Practices

<sup>108</sup>Young, G. K., Stein, S., Cole, P., Kammer, T., Graziano, F., and Bank, F., Evaluation and Management of Highway Runoff Water Quality." Publication No. FHWA-PD-96-032 (June 1996)

<sup>109</sup>Venner, M., AASHTO Compendium of Environmental Stewardship Practices, Ch. 7: Bridge Maintenance, 2004, online at [transportation.environment.org/http://environment.transportation.org/environmental\\_issues/construct\\_maint\\_prac/compendium/manual/7\\_1.aspx](http://transportation.environment.org/http://environment.transportation.org/environmental_issues/construct_maint_prac/compendium/manual/7_1.aspx). Also see: Venner and Kober, 2002, AASHTO CEE consulting engagement for the Kentucky Transportation Cabinet, Bridge Washing and Painting Practices

<sup>110</sup>Perkins, R., and Hazirbaba, Y., Alaska UTC and DOT & Public Facilities, Bridge Deck Runoff: Water Quality Analysis and BMP Effectiveness, December 2010, p. 34

<sup>111</sup>Project interview with Mark Maurer, Washington State DOT, December 2012

<sup>112</sup>Project interview with Mark Maurer, Washington State DOT, December 2012

<sup>113</sup>Project interview with Sean Connolly, South Carolina DOT, January 9, 2013

<sup>114</sup>Project interview with Gabe Robertson, Nebraska DOR, December 17, 2012

<sup>115</sup>ADOT, Project interview with Mark Maurer, PLA, PE, Highway Runoff Program Manager Washington State Department of Transportation, December 18, 2012, Project interview with Amy Tootle and Rich Renna, Florida DOT, December 18, 2012

<sup>116</sup>Project interview with Mark Maurer, PLA, PE, Highway Runoff Program Manager Washington State Department of Transportation, December 18, 2012

**Table A-1. BMP types.**

Level I Treatment	Level II Treatment	Design-Related	Maintenance
Bioretention Basin	Conveyance Channel	Closed System	Bridge Stormwater
Catch Basin Insert (CBI)	Energy Dissipator	Deck Conveyance	Collection and
Dry Detention Basin	Level Spreader	Dispersion	Conveyance Assessment
Filter Strip	Preformed Scour Hole (PFSH)	Environmental Site Design	(BSCCA)
Filtration Basin	Stream Bank Drop Structure	(ESD)	Bridge Sweeping
Infiltration Basin	(SBDS)	Stormwater Mitigation	
Stormwater Wetland			
Swale			

railings were a source of zinc contamination in runoff. Coatings for exposed galvanized metals have the potential to reduce such discharges.

- **Configuration of the deck cross section (curbed or open at pavement level)** was found to be a factor in a bridge deck runoff by Wu and Allen, as it could impact the buildup of pollutants.
- **Smart controllers** in DOT equipment, applying herbicides and deicing materials using GPS to distribute the amount of chemical according to needs and can reduce the amount of the material that enters the environment and that is ultimately washed off of roads.
- **Catch basin cleaning practice and design** that facilitates cleaning. One design option consists of a series of trays, with the top tray serving as an initial sediment trap; the underlying trays filter out pollutants.<sup>117</sup> Michigan Council of Governments (SEMCOG 2009) describes another design option that uses filter fabric to remove pollutants from runoff.<sup>118</sup> Frequency and consistency of cleaning improves performance. As with sweeping, it is important to remove accumulated sediments before those are flushed downstream.

### Comparative Effectiveness of BMP Types for Bridges

NCDOT’s joint final report with USGS and the state Division of Water Quality on Stormwater Runoff from Bridges contains one of the most comprehensive summaries of BMP types for bridge deck runoff. BMP Types are categorized as shown in Table A-1.

<sup>117</sup> NCDOT/URS, Stormwater Runoff from Bridges, Final Report to Joint Legislation Transportation Oversight Committee, North Carolina Department of Transportation (2010), p. 32

<sup>118</sup> Southeast Michigan Council of Governments, SEMCOG. (2009). Catch Basin Cleaning www.semco.org Statewide Transportation Improvements Program (STIP). Retrieved

Each BMP summary contains the following information:<sup>119</sup>

- **Snapshot table** indicating the BMP category and ratings on identified characteristics based on available literature,<sup>120</sup> general knowledge, and best engineering judgment. Judgment rationale included consideration of a BMP’s specific bridge application, experience with a particular BMP, understanding of unit processes, and general knowledge of relative costs.
  - Water Quality: In general, how effective is the BMP at reducing pollutant loads?
  - Volume Reduction: How well does the BMP reduce the inflow hydrograph volume?
  - Peak Rate Attenuation: How well does the BMP reduce the peak flow rate?
  - Groundwater Recharge: How well does the BMP replenish groundwater?
  - Cost: What are the construction costs relative to other BMPs?
  - Land Requirement: How large is the BMP footprint relative to other BMPs and what is the probability of right-of-way acquisition?
  - Possible Site Constraints: What is the relative probability of encountering issues with placement of the BMP at a bridge site based on the physical characteristics of the BMP?
  - Maintenance Burden: What is the relative level of effort, considering frequency, cost, and scope of maintenance activities required to keep the BMP functioning as intended?

<sup>119</sup> Adapted from NCDOT 5A-2

<sup>120</sup> Particularly important sources were PADEP, 2006. *Stormwater Best Management Practices Manual*. Document Number 363-0300-002. Harrisburg, PA: Pennsylvania Department of Environmental Protection, Bureau of Watershed Management; NCDENR, 2007. *Stormwater Best Management Practices Manual*. Raleigh, NC: North Carolina Department of Environment and Natural Resources, Division of Water Quality

- **Description.** A brief overview of the BMP, including a description of the basic design concept and functionality.
- **Bridge Implementation.** A description of how and where the BMP is typically put into practice at bridge sites.
- **Key Considerations.** A summary of important information related to the design, construction, and maintenance of the BMP that should be considered in the selection process.
- **Cost.** A summary of bridge implementation considerations follows, adapted from NCDOT’s Appendix 5-A of their joint final report with USGS and the state Division of Water Quality. Where noted, ratings are supplied by the following pre-existing documents:<sup>121</sup>
  - a. PADEP, 2006. Stormwater Best Management Practices Manual. 363-0300-002. Harrisburg, PA: Pennsylvania Department of Environmental Protection, Bureau of Watershed Mgmt.
  - b. NCDENR. 2007. Stormwater Best Management Practices Manual. Raleigh, NC: North Carolina Department of Environment and Natural Resources, Division of Water Quality.
  - c. NCDOT. 2010. Stormwater Control Inspection and Maintenance Manual. HSP-2010-01. <http://ncdot.org/programs/environment/stormwater/download/SWControlInspectionMaintJan2010.pdf>

**Bioretention basins** can be located down-grade of a bridge deck. Bridge runoff can enter a basin via sheet flow, but typically runoff is directed to a basin via a bridge deck collection system. A pretreatment

Water Quality <sup>a</sup>	High
Volume Reduction <sup>a</sup>	Medium
Peak Rate Attenuation <sup>a</sup>	Low-Med
Groundwater Recharge <sup>a,b</sup>	Low-High
Cost <sup>a,b</sup>	Med-High
Land Requirement <sup>a</sup>	High
Possible Site Constraints <sup>a</sup>	High
Maintenance Burden <sup>b</sup>	Med-High

BMP (i.e., forebay) is recommended upstream of a bioretention basin, especially in cases of high sediment load. Right-of-way acquisition may be necessary due to basin size, location relative to bridge, etc. Bioretention basins should be located where adequate sunlight is available for vegetation. Bioretention basins may require watering during periods of drought and bioretention basins may require more maintenance initially while vegetation is being established.

Maintenance frequency of a bioretention basin is a function of the pollutant loads reaching the facility and the type of vegetation specified. In general, maintenance activities include maintaining vegetation; removal of trash, sediment, and debris; and cleaning/flushing of the underdrain system (when present). Periodic replacement of filter media may be required.

<sup>121</sup> Adapted from NCDOT 5A-2

Construction cost varies by basin size, which is based on drainage area and percent imperviousness. A 2012 NCDOT study of bioretention and swales found that both were effective in treating bridge deck runoff to some degree, though bioretention had greater pollutant removal outside of TSS. When employing the percent load reduction metric, the small bioretention cell achieved 60-90% of the load reductions that were achieved by the large cell for all pollutants except total phosphorus (TP), despite the fact that the small cell only captured 30% of the design storm.<sup>122</sup> Undersized bioretention cells are a viable retrofit option to achieve hydrologic and pollutant removal goals since undersized cells achieve volume reductions comparable to full-size systems; however, it is unknown if the reduced benefit associated with an undersized system would justify its lower capital cost.<sup>123</sup> Arizona DOT listed the following benefits: Can be very effective for removing fine sediments, trace metals, nutrients, bacteria and organics as well as suited for impervious areas and widely applicable to different climatic zones and limitations: (1) Pretreatment is necessary to avoid clogging; (2) Not suitable in climates where soil can freeze; (3) Not recommended for upstream slopes greater than 20%; (4) Not suitable for distance to aquifers less than 6 feet; and (5) Bioretention BMPs can attract mosquitoes and other environmental nuisances.<sup>124</sup> ADOT concluded that bioretention might be appropriate along facilities such as port-of-entries and rest areas.<sup>125</sup>

**Bridge Sweeping.** When structural BMPs are found to be impractical, sweeping can provide a practical alternative.<sup>126</sup> Bridge sweeping may be an attractive option for longer bridges where collection and conveyance of stormwater to a treatment BMP is not feasible and costs are prohibitive. A program should be developed to optimize water quality benefits (sweeping frequency) relative to costs. Proper traffic

Water Quality <sup>a</sup>	Low
Volume Reduction <sup>a</sup>	N/A
Peak Rate Attenuation <sup>a</sup>	N/A
Groundwater Recharge <sup>a</sup>	N/A
Cost	Med-High
Land Requirement	None-Low
Possible Site Constraints	None-Low
Maintenance Burden	Low

<sup>122</sup> S. K. Luell, R. J. Winston, C. E. Wilson, S. G. Kennedy, W. F. Hunt, “Retrofitting with Bioretention and a Swale to Treat Bridge Deck Stormwater Runoff,” NCDOT Research Project 2011-12, Final Report, North Carolina Department of Transportation, November 27, 2012, p. 87

<sup>123</sup> S. K. Luell, R. J. Winston, C. E. Wilson, S. G. Kennedy, W. F. Hunt, “Retrofitting with Bioretention and a Swale to Treat Bridge Deck Stormwater Runoff,” NCDOT Research Project 2011-12, Final Report, North Carolina Department of Transportation, November 27, 2012, p. 88

<sup>124</sup> Arizona DOT post-construction BMP manual, Appendix Table B-3, p. 160 of .pdf.

<sup>125</sup> Arizona DOT post-construction BMP manual, Appendix Table B-3, p. 160 of .pdf.

<sup>126</sup> Shoemaker, L., Lahlou, M., Doll, A, Cazenias, P. 2002. *Stormwater Best Management Practices in Ultra-Urban Setting: Selection and Monitoring*. Washington, DC: U.S. Department of Transportation, Federal Highway Administration. <http://www.fhwa.dot.gov/environment/ultraurb/index.htm>.



control practices must be executed throughout the sweeping process. Air quality impacts should be minimized by utilizing sweepers that include dust control mechanisms.

Notably, the introduction of vacuum-assisted and regenerative air sweepers (which blow air onto the pavement and immediately vacuum it back to entrain and filter out accumulated solids) has greatly increased effectiveness, particularly with fine particles. In addition, improved methods such as tandem sweeping (i.e., mechanical sweeping followed immediately by a vacuum-assisted machine) have shown marked increases in percent pollutant reductions.<sup>127</sup>

**Bridge stormwater conveyance and collection (BSCAC)** involves inspection of bridge stormwater conveyance and collection systems with the purpose of identifying and documenting potential need for improvements to correct, minimize, or avoid erosion problems that could potentially impact receiving waters. NCDOT is considering incorporating this non-structural BMP into existing bridge maintenance inspections, which are performed every two years for all bridges in the state. To implement BSCAC statewide, additional training of inspectors and additional effort during the inspection process would be needed for recognition and documentation of potential conveyance and collection problems.

Water Quality	NA
Volume Reduction	NA
Peak Rate Attenuation	NA
Groundwater Recharge	NA
Cost	Low
Land Requirement	NA
Possible Site Constraints	NA
Maintenance Burden	Low

Improvement needs would then be forwarded to Hydraulics Division staff for prioritization, design, and implementation of a solution and/or potential future retrofit.

**Catch basin inserts (CBI)** can be implemented downgrade from a bridge deck collection system or in catch basins that receive bridge runoff or are connected to a bridge drain system. These devices are typically proprietary treatment that consists

Water Quality	Low
Volume Reduction	N/A
Peak Rate Attenuation	N/A
Groundwater Recharge	N/A
Cost	Low
Land Requirement	N/A
Possible Site Constraints	Low
Maintenance Burden	Med

of a manufactured insert suspended in a catch basin or storm drain to filter pollutants (targeted and removed depending on the design and catch basin configuration). CBIs are a potential alternative for retrofit applications where available land is limited. They cannot remove pollutants as well as other structural

treatment BMPs and cannot effectively remove soluble pollutants or fine particles, according to USEPA.<sup>128</sup>

CBIs require frequent maintenance and can become a source of pollutants through re-suspension if not properly maintained, which consists of trash removal and removal of sediment (which may require use of a vactor truck) and/or replacement of a filter bag, cartridge or media. Traffic control may be required for maintenance activities and collected material must be disposed of in accordance with current environmental regulations.

**Designed closed systems (pipes)** collect bridge deck runoff (a design-storm amount) and convey that to a point of discharge for purposes of stormwater management. Closed systems maintain

Water Quality	N/A
Volume Reduction	N/A
Peak Rate Attenuation	N/A
Groundwater Recharge	N/A
Cost	Med-High
Land Requirement	Low
Possible Site Constraints	Low
Maintenance Burden	High

hydraulic conveyance (spread) outside the travel lane and are typically composed of deck drains and hanging pipe systems, and are sometimes utilized for large or long new location or replacement bridges where deck conveyance is not practical. Treatment BMPs are likely to be needed at the outlet to dissipate discharge energy and prevent erosion and expansion fittings should be considered in the design at bridge joints and other locations.

Significant maintenance burden should be anticipated, including removal of solids, trash, and debris; repairing separated or broken sections of pipe and eliminating clogs. Cost depends on the system configuration, number of expansion fittings, length, pipe size, pipe material, and other similar considerations.

**Conveyance channels** (stabilized channels to convey runoff from a bridge) prevent erosion and sedimentation by providing a stable conveyance from a bridge to an energy dissipater or streambank structure. Conveyance channels can be implemented downgrade of a bridge deck and receive stormwater from a bridge deck collection system. They typically do not require additional right-of-way and should have a minimum design capacity to handle a 10-year storm event and consider the hydraulic capacity of upstream conveyances tributary to the channel.

Water Quality	N/A
Volume Reduction	N/A
Peak Rate Attenuation	N/A
Groundwater Recharge	N/A
Cost <sup>a</sup>	Low
Land Requirement <sup>a</sup>	Low
Possible Site Constraints <sup>a</sup>	Low
Maintenance Burden <sup>a</sup>	Low

Conveyance channels can be implemented downgrade of a bridge deck and receive stormwater from a bridge deck collection system. They typically do not require additional right-of-way and should have a minimum design capacity to handle a 10-year storm event and consider the hydraulic capacity of upstream conveyances tributary to the channel.

<sup>127</sup> Sutherland and Jelen, 1997, cited in NCHRP Report 474, volume 2, p. 69.

<sup>128</sup> USEPA Office of Wastewater Management (OWM). National Menu of Stormwater Best Management Practices. Catch Basin Inserts Fact Sheet. USEPA. <http://www.epa.gov/npdes/stormwater/menuofbmps> (Search Catch Basin Inserts).

Conveyance channels may be provided to collect runoff from bridge scuppers. They are typically lined with riprap since immediate stabilization is required. Maintenance activities include removal of sediment, trash, and debris. Riprap may need to be added or replaced periodically. Construction costs are largely a function of excavation and grading costs and the cost of the lining material, and depend on channel length.

**Deck conveyance**

involves widening of the bridge deck to accommodate collection and conveyance of bridge deck runoff from a design storm, to keep runoff within the shoulder area and convey it to a treatment location in the abutment area. Though it involves construction of more deck/impervious surface area, deck conveyance is generally more cost effective than piping or closed systems on small new location or replacement bridges. Flow spread criteria must be considered in the widening design and appropriate collection, conveyance and treatment provided where deck conveyance reaches the end of the bridge.

Costs include additional deck construction and maintenance activities include removal of sediment, trash, and debris in the flow path.

**Dispersion** is design to allow bridge deck runoff to discharge into the environment without collection and conveyance. Instead of one or a few point source discharges from a collection system, dispersion encourages diffuse flow

Water Quality	N/A
Volume Reduction	N/A
Peak Rate Attenuation	N/A
Groundwater Recharge	N/A
Cost	Low
Land Requirement	Low
Possible Site Constraints	Low
Maintenance Burden	Low

Water Quality	N/A
Volume Reduction	N/A
Peak Rate Attenuation	N/A
Groundwater Recharge	N/A
Cost	Low
Land Requirement	Low
Possible Site Constraints	Low
Maintenance Burden	Low

over a large area by releasing flow from the bridge deck directly onto well-vegetated areas, open water, channels, or buffer zones. NCDOT considers dispersion on bridges from a height of 12 feet or more and where concentrated flow from other drainage systems can be diverted away from the dispersion area.<sup>129</sup> Dispersion reduces the need for additional ROW.

Over ground, the cover beneath the bridge needs to be of a surface material that will withstand impact from dispersed runoff. In addition, the topography of the land receiving dispersed flow needs to encourage sheet flow so that re-concentration of runoff does not occur. The flow path from

the bridge surface should be inspected to verify that flow is not obstructed. Maintenance needs can be assessed at the time of bridge inspections. Dispersion is likely to be the lowest cost management approach; since the cost of designing and installing scupper systems are incorporated into the cost of bridge structure construction, dispersion does not represent a separate stormwater treatment expense.

**Dry detention basins**

can be constructed downslope of the bridge, receiving stormwater runoff from a bridge deck collection system, or as sheet flow from the bridge deck. A dry detention basin may also be used in series with other controls such as forebays, filter strips, or swales to meet pollutant removal efficiency requirements. Such basins temporarily collect and store stormwater runoff and gradually release it to a receiving stream. Dry detention basins attenuate peak flows, promote settlement of suspended solids and particulate-bound pollutants, and reduce erosive velocities downstream.

These basins are typically designed to capture stormwater and release it through a primary outlet control structure over a two to five day period and designed to remain dry in between storm events. ROW acquisition may be necessary due to basin size, location relative to bridge, and other possible site constraints, and sediment basins that are used during construction can be converted into dry detention basins once construction is completed. The required minimum design surface area with a length-to-width ratio needs to be considered during site selection; construction cost varies by basin size, which is determined by drainage area and percent imperviousness. Vegetation maintenance (mowing) may be required.

Water Quality <sup>a</sup>	Low
Volume Reduction <sup>a</sup>	Low
Peak Rate Attenuation <sup>a</sup>	High
Groundwater Recharge <sup>a</sup>	NA
Cost <sup>b</sup>	Low
Land Requirement <sup>a</sup>	Med
Possible Site Constraints <sup>b</sup>	Med
Maintenance Burden <sup>b</sup>	Low-Med

**Energy dissipaters** (e.g., riprap in preformed scour holes or rock aprons) can be implemented downgrade of a bridge deck and can receive stormwater from several sources including bridge deck collection system, underneath bridge scuppers, or downgrade of another BMP. They should be designed to reduce velocity of the outfall to a non-erosive rate for the design storm of the contributing facility or the 10-year event, and should be sited on level grade, where possible. At minimum, the downgrade edge of the dissipater must be level perpendicular to the flow line.

Water Quality	N/A
Volume Reduction	N/A
Peak Rate Attenuation	N/A
Groundwater Recharge	N/A
Cost	Low
Land Requirement	Low
Possible Site Constraints	Low
Maintenance Burden	Low

Maintenance activities include removal of sediment, trash, and debris. Riprap may need to be added or replaced periodically.

<sup>129</sup>Henderson, D. R. 2002. Bridge Deck Drains Memo to Hydraulics Project Managers, NCDOT. Dated July 18, 2002. North Carolina Department of Transportation, Hydraulics Unit. <http://www.ncdot.org/doh/preconstruct/highway/hydro/pdf/BridgeDeckDrainGuidelinesJuly02.pdf>

**Environmentally sensitive design (ESD)** utilizes natural topography downgrade of a bridge deck to receive stormwater from a bridge deck collection system. ESD techniques infiltrate, filter, store, evaporate, and detain runoff close to its source and promote the natural movement of water within a watershed. The Maryland Department of Environment (MDE) has characterized ESD as “a comprehensive design strategy for maintaining pre-development runoff characteristics and protecting natural resources” (MDE 2009).

Water Quality	N/A
Volume Reduction	N/A
Peak Rate Attenuation	N/A
Groundwater Recharge	N/A
Cost	Low
Land Requirement	Low
Possible Site Constraints	Low
Maintenance Burden	Low

North Carolina also promotes this strategy, focusing on utilizing existing areas, natural or previously disturbed, to treat stormwater with little or no modification. A dry detention basin created using a naturally existing depressed area may be described as an environmental design basin. The natural topography needs to match the final graded needs of the BMP to which ESD is being applied. (In most cases, energy dissipation will be needed upgrade of a natural ESD.) In addition to energy dissipation, other ESDs may require a slight retrofitting such as an outlet structure. ESDs reduce construction effort and cost as well as require less maintenance in most cases.

**Vegetated Filter strips** can be implemented downslope of a bridge deck, underneath the bridge deck, or along bridge deck embankments in areas receiving stormwater runoff from a bridge deck runoff collection system, or via sheet flow. For instances where runoff is supplied by a bridge deck collection system, a level spreader, preformed scour hole, or weir is required to promote diffuse flow upgrade of the filter strip. Sheet flow across the filter strip is treated through infiltration into the soil. Filter strips are typically located in series with other devices that promote diffuse flow, such as level spreaders or preformed scour holes.

Water Quality <sup>a,b</sup>	Med-High
Volume Reduction <sup>a</sup>	Low-Med
Peak Rate Attenuation <sup>a,b</sup>	Low
Groundwater Recharge <sup>a</sup>	Low-Med
Cost <sup>b</sup>	Low
Land Requirement <sup>b</sup>	Med
Possible Site Constraints <sup>b</sup>	Med
Maintenance Burden <sup>b</sup>	Low

Any natural vegetated area may be adapted for use as a filter strip, though additional right-of-way may be required to provide sufficient flow length and gradient. Vegetation should reasonably tolerate standing water, resist erosion, resist excessive bending when subject to runoff flows, and be as dense as possible. Soil and groundwater conditions that allow for high infiltration rates will increase the water quality benefits. Filter strips are relatively inexpensive BMPs with the majority of the associated cost due to grading and planting costs; however, filter strips should be periodically inspected and maintained to sustain good vegetative cover and to remove rills

formed by concentrated flow and excessive sediment deposition. The formation and maintenance of sheet flow across the filter strip is critical to their successful operation.

**Filtration basins** can be installed downgrade of the bridge, receiving stormwater runoff from a bridge deck collection system or as sheet flow from the bridge deck; however, a pretreatment BMP is recommended upstream of a filtration basin,

Water Quality <sup>a</sup>	High
Volume Reduction	Low
Peak Rate Attenuation <sup>a</sup>	Low-Med
Groundwater Recharge <sup>b</sup>	Low
Cost <sup>b</sup>	Med-High
Land Requirement <sup>b</sup>	High
Possible Site Constraints <sup>b</sup>	High
Maintenance Burden <sup>b</sup>	Med

especially in cases of high solids load, as this treatment-type BMP detains and routes stormwater through filter media. As stormwater infiltrates through the amended soil, sand, or engineered media of the filter, pollutants are filtered and adsorbed onto particles. Stormwater vacates the basin through an underdrain system and is directed back to the receiving stream.

A filtration basin can be used in areas where the soils are not suitable for infiltration systems. They may require additional ROW due to the filter size, location relative to bridge, and other possible site constraints. Filtration basins have underdrain systems (designed to resist clogging) with cleanouts to facilitate inspection and maintenance activities. The filter bed will have an outlet control device to collect underdrain flows and direct flow to the receiving stream, typically designed to discharge flow above the prescribed treatment elevation. Maintenance frequency of a filtration basin is a function of the pollutant loads reaching the facility. In general, maintenance activities include removal of trash, sediment, and debris and cleaning/flushing of the underdrain system. Periodic replacement of filter media may be required.

**Infiltration basins** can be implemented downgrade from the outlet of a bridge deck runoff collection system or underneath the bridge deck, where the hydraulic conductivity of the site soils is adequate for infiltration. Underdrain systems are not incorporated. Pollutant removal capacity can be high because most pollutants associated with water quality volume are filtered or adsorbed by surficial soils, though highly soluble pollutants may persist in groundwater. Due to the size of infiltration basins, additional right-of-way may be necessary.

Water Quality <sup>a,b</sup>	High
Volume Reduction <sup>a</sup>	High
Peak Rate Attenuation <sup>a</sup>	Med-High
Groundwater Recharge <sup>a</sup>	High
Cost <sup>b</sup>	Med-High
Land Requirement <sup>b</sup>	High
Possible Site Constraints <sup>b</sup>	High
Maintenance Burden <sup>b</sup>	Med

If the existing soil does not have a high infiltration rate, the surface area of the basin may become prohibitively large. Site soils must be able to infiltrate stormwater in the basin within a specific period of time. Pretreatment with an upstream BMP is necessary to remove solids that can clog the infiltration basin and reduce the infiltration rate. Care must be



taken during construction activities to protect the infiltration basin area from construction traffic, material laydown, and other activities that can compact soils and reduce infiltration capacity. Construction cost varies by basin size, which is based on drainage area and percent imperviousness, and hydraulic capacity of in-situ soils. The frequency of maintenance will largely depend on the pollutant loads to the infiltration basin. DOTs must remove debris, trash, and sediment buildup from the basin as necessary to maintain the permeability of the soil. Arizona DOT's evaluation of BMPs favored infiltration for treating runoff collected at a single point as it can theoretically achieve 100% removal of dissolved and colloidal pollutants to surface water bodies while reducing peak flows and eliminating downstream bank erosion.<sup>130</sup>

However, ADOT uses infiltration with caution due to several known limitations, including (1) High failure rates due to improper siting, design, and lack of maintenance, especially when no pretreatment is included; (2) Clogging likely under high suspended solid loading; (3) Lack of suitability below steep slopes; (4) Possible groundwater contamination; violation of Aquifer Protection Permit (APP) standards; and (5) Requiring complete stabilization of upstream drainage area.<sup>131</sup>

**Level spreaders** can be implemented downgrade of a bridge deck or underneath the bridge deck with both applications receiving stormwater runoff from a bridge deck collection system. A level spreader can also be used in series with other treatment options to optimize hydraulic and water quality benefits, providing a non-erosive outlet for runoff by distributing concentrated water uniformly across a large area of a stable slope (dispersion). The structure consists of a level concrete or vegetated trough with a non-erosive lip that discharges into a vegetated area.

Level spreaders can also be used in series if the slope is too steep from the trough to the stream. Verification of surficial soils may be necessary using soil surveys or existing geotechnical reports to determine if site can support a vegetated trough. Maintenance activities include removal of sediment, trash, and debris from the level spreader trough and other components. Inspections must confirm that the level spreader lip is not damaged and that flow is not bypassing the lip as the lip must create uniform, diffuse flow for the control to function properly. Construction cost is a function of type of level spreader (concrete lip or vegetated trough) and

Water Quality <sup>a</sup>	Low
Volume Reduction <sup>a</sup>	Low
Peak Rate Attenuation <sup>a</sup>	Low
Groundwater Recharge <sup>a</sup>	Low
Cost <sup>a,b</sup>	Low-High
Land Requirement <sup>a,b</sup>	Low-High
Possible Site Constraints <sup>a,b</sup>	Med
Maintenance Burden <sup>a,b</sup>	Med

<sup>130</sup> Arizona DOT post-construction BMP manual, Appendix Table B-3, p. 160 of .pdf

<sup>131</sup> Arizona DOT post-construction BMP manual, Appendix Table B-3, p. 160 of .pdf

length/configuration. The spreader lip must be absolutely level to operate correctly; this requirement is often difficult to achieve in practice.

**Preformed scour holes (PFSH)** or pre-shaped, riprap-lined basins can be located directly downgrade of an outfall or underneath the bridge deck. The basin is stabilized with filter fabric and riprap to absorb the impact of the discharge

Water Quality	N/A
Volume Reduction	N/A
Peak Rate Attenuation	N/A
Groundwater Recharge	N/A
Cost	Low
Land Requirement	Low
Possible Site Constraints	Low
Maintenance Burden	Low

(i.e., energy dissipation) and to prevent additional erosion. Once runoff has filled the shallow basin, it overtops the preformed scour hole and is redistributed as diffuse flow to the surrounding area. By inducing diffuse flow conditions, preformed scour holes reduce downgrade erosion and promote infiltration and filtration in the flat, vegetated land surface.

PFSHs require a small footprint and typically do not require additional right-of-way. The ground downgrade of the PFSH must be at a gradient that maintains a non-erosive flow velocity and diffuse flow. If the PFSH is used for energy dissipation only, runoff can exit the preformed scour hole to an alluvial channel. Maintenance activities include removal of sediment, trash, and debris. The riprap base should be inspected to ensure that no rock has been dislodged or removed.

**Off-site stormwater mitigation** is a design-related BMP that describes a system of providing offsite treatment to compensate for sites where treatment is not practicable or when there is a larger environmental and economic benefit from implementing stormwater controls in other areas of the watershed. Bridge sites may be limited by site constraints that reduce BMP construction feasibility and negatively impact cost-effectiveness. Off-site stormwater mitigation provides an avenue for stormwater control to be provided elsewhere in the watershed where implementation is more practicable.

Water Quality	High
Volume Reduction	High
Peak Rate Attenuation	High
Groundwater Recharge	High
Cost	Low
Land Requirement	Med-High
Possible Site Constraints	Low
Maintenance Burden	Low

With proper planning, offsite stormwater mitigation can reduce construction and maintenance costs. An accounting program to track offsite mitigation activities must be developed. If desired, the multiple other ecological benefits of off-site mitigation can also be tracked. A DOT may further reduce costs through advance planning and coordination with multiple projects and units of government. Off-site mitigation can be somewhat unique in its capacity to deliver high levels of water quality, volume reduction, peak-rate attenuation, and groundwater recharge at low cost.

With proper planning, offsite stormwater mitigation can reduce construction and maintenance costs. An accounting program to track offsite mitigation activities must be developed. If desired, the multiple other ecological benefits of off-site mitigation can also be tracked. A DOT may further reduce costs through advance planning and coordination with multiple projects and units of government. Off-site mitigation can be somewhat unique in its capacity to deliver high levels of water quality, volume reduction, peak-rate attenuation, and groundwater recharge at low cost.



**Stormwater wetlands**

can be implemented down-grade from the outlet of a bridge deck runoff collection system. These engineered wetlands with dense vegetation remove pollutants primarily through biological processes, evapotranspiration and infiltration. Stormwater wetlands sometimes evolve from failed infiltration basins.<sup>132</sup> Like infiltration basins, stormwater wetlands improve both water quality and help mimic pre-development hydrology; the extent of the improvement in water quality depends on the soils and vegetation.

Stormwater wetlands designed specifically for stormwater treatment are distinguished from naturally-occurring wetlands by having distinct inlet and outlet structures. Like infiltration basins, right-of-way acquisition may be necessary as stormwater wetlands require a large surface area. Soils with low permeability should be present because a constant water level should be maintained in the wetland. If soils have a high permeability, a liner will be needed. Dry weather flow may be necessary to keep vegetation alive. Plant selection in stormwater wetlands is critical, and it should be specified by an appropriate professional. Maintenance activities include removal of trash, dead or undesirable vegetation, and debris. Dead or dying vegetation and undesirable vegetation should be removed. A 2012 study found high bacterial counts at the out-fall of a treatment wetland designed for bridge deck runoff. The researchers concluded that the wetlands are being utilized by raccoons, squirrels, deer, birds and other wildlife and that their feces were re-contaminating the water, negating any bacterial removal that the wetland initially provides to the water entering it though “the wetlands might provide other nutrient or water quality enhancement benefits such as serving as settling areas for sediments or removing nutrients or other pollutants from the stormwater runoff coming from the bridge deck.”<sup>133</sup> Other limitations are: possible release of nutrients during the fall season and discharges from constructed wetlands may be warmer than the temperature of receiving surface water body (heat sink effect).<sup>134</sup> ADOT listed the following benefits for wetlands: high aesthetic value; improved treatment over dry detention and retention; flood attenuation; reduction of peak flows; and limits downstream bank erosion.<sup>135</sup>

Water Quality <sup>a</sup>	High
Volume Reduction <sup>a,b</sup>	Low-Med
Peak Rate Attenuation <sup>a</sup>	High
Groundwater Recharge <sup>a</sup>	Low
Cost <sup>b</sup>	Med
Land Requirement <sup>b</sup>	High
Possible Site Constraints <sup>b</sup>	Med
Maintenance Burden <sup>b</sup>	Med

**Stream bank drop structures**

are implemented downslope at the discharge point of collection and conveyance facilities of the bridge to safely convey bridge deck and/or roadway runoff into a waterway. The structure minimizes erosion caused by concentrated storm-water flows when existing surface cover does not provide adequate protection, preventing sedimentation in the receiving water and thus the bridge impact on the stream. Stream bank drop structures generally consist of riprap or concrete sloped or vertical drops to locally protect the stream bank from erosion.

The contributing factors to stream bank erosion must be evaluated and identified in order to select the most appropriate stabilization method; the possibility of utilizing vegetative stabilization in conjunction with structural stabilization should be evaluated. At minimum, structures should be designed for the 10-year storm event. The hydraulic capacity of upstream conveyances should be considered in the design.

**Swales**

typically have denser vegetation and flatter slopes than most flood management drainage channels. Swales can be implemented downgrade of a bridge deck and receive stormwater from a bridge deck collection system. These broad and shallow channels with dense vegetation convey and treat peak runoff by decreasing stormwater runoff velocity and promoting infiltration and physical filtration. They fit well in linear areas, usually along roadways and medians, and tend to be better suited to smaller drainage areas due to the maximum allowable discharge velocities.

Check dams may be required depending on the longitudinal slope. Swales are typically sized to treat frequently-occurring storm events and the length is generally related to the size of the drainage area. Maintenance activities include removal of sediment, trash, and debris and the repair of eroded areas and sometimes mowing for aesthetic purposes. Costs tend to be low (mostly excavation during construction). When incorporated into roadway or facility design as part of the conveyance system, swales can provide water quality benefits and be aesthetically pleasing. Swales remove coarse sediment better than fine sediment and since highway stormwater runoff is expected to contain relatively coarse sediment,<sup>136</sup>

Water Quality	N/A
Volume Reduction	N/A
Peak Rate Attenuation	N/A
Groundwater Recharge	N/A
Cost	Low-Med
Land Requirement	Low
Possible Site Constraints	Low
Maintenance Burden	Low-Med

Water Quality <sup>a,b</sup>	Low-Med
Volume Reduction <sup>a,b</sup>	Low-Med
Peak Rate Attenuation <sup>a,b</sup>	Low-Med
Groundwater Recharge <sup>a</sup>	Low-Med
Cost <sup>b</sup>	Low
Land Requirement <sup>b</sup>	Low
Possible Site Constraints <sup>b</sup>	Low
Maintenance Burden <sup>b</sup>	Low

<sup>132</sup> NCHRP 25-40 interview with Karuna Pujara, Maryland SHA Hydraulics Chief, May 31, 2011

<sup>133</sup> Fleckenstein, E., Final Report for Task Order #40: Bacterial Sampling—NCCF, Preliminary Assessment of Potential Bacterial Loading off the Virginia Dare Bridge in Dare County, NC. 2010

<sup>134</sup> Arizona DOT Post-Construction BMP Manual, p. 160 of the .pdf document. Appendix B. Table B-3

<sup>135</sup> Arizona DOT Post-Construction BMP Manual, p. 160 of the .pdf document. Appendix B. Table B-3

<sup>136</sup> Sansalone, J. J., Koran, J. M., Smithson, J.A, and Buchberger, S. G. (1998). Physical characteristics of urban roadway solids transported during rain events. *Journal of Environmental Engineering*, 124(5), 427-440

swales are an appropriate means of TSS reduction from highway runoff.<sup>137</sup> More information about swales is available in NCDOT's Bioretention and Swale study.<sup>138</sup>

## Emerging BMPs for Potential Use on Bridges

Interviewed DOTs staff expressed interest in emerging BMPs and alternative treatment approaches given the difficulties inherent in treating on-site with known methods. Most DOTs did not have emerging treatment mechanisms to share with others, though some said they were "working on it."

Emerging BMPs identified in the interview process and literature review included the following:

### Planning Mechanisms

- Louisiana is performing a statewide assessment of water quality at existing and future bridge crossings to assist with the development of runoff management strategies. The state regulatory agency is undertaking the study, to which LADOTD will add bridges, so that the agencies can identify bridge crossings over sensitive waters. LADOTD plans to proactively address bridge deck runoff wherever possible, in those areas.
- Some DOTs have identified off-site mitigation areas where treatment could be accomplished more efficiently on a watershed level. Florida DOT has taken the lead in convening the state's Water Management Districts to talk about cooperative stormwater opportunities with the state DOT.<sup>139</sup> FDOT also has a provision for off-site compensation (See Attachment A-1). North Carolina's Division of Water Quality asked NCDOT to develop a proposal for off-site mitigation as a solution for effective watershed stormwater mitigation where BMPs for bridges are problematic or not practicable, where more stormwater mitigation could be gained for dollar spent, and where retrofit projects are to be constructed. Off-site stormwater mitigation and treatment practices are currently implemented in other states, such as California, Delaware, Florida, and Maryland.

### Alternatives to Treatment of Bridge Deck Runoff

- **Stormwater re-use by municipalities.** This would involve municipalities taking FDOT's stormwater and re-using it for irrigation or groundwater recharge. FDOT is working on stormwater re-use statewide, to team up with municipalities to do stormwater re-use.

<sup>137</sup> NCDOT bioretention and swale study, 2012, p. 11

<sup>138</sup> NCDOT bioretention and swale study, 2012, pp. 22–25

<sup>139</sup> Project interview with Amy Tootle and Rich Renna, Florida DOT, December 18, 2012

### Dispersion

- **Dispersion on vegetation.** In the mountains on relatively high bridges, NCDOT has used the scupper dispersion method where vegetation underneath acts as an interceptor.
- **Equivalent area treatment** enables a DOT to treat a similar area to the (then untreated) bridge deck in another untreated spot in the corridor. This is a standard approach in Maryland.
- **Investment in off-site mitigation,** whether regional treatment or natural resource areas that offer filtration benefits for pollutants of concern, may be accepted by regulators in exchange for avoidance of less cost-effective on-site treatment.

As an innovative approach, Washington has developed a watershed-based process for addressing stormwater (and other resource impacts) that includes leveraging funds for higher-priority local stormwater projects, water quality enhancement at an off-site wetland, and cost sharing on regional treatment off site. Other states that mentioned they use compensating mitigation include Rhode Island, Maine, Massachusetts, and Delaware. According to a memorandum of understanding between the Delaware DOT and the state environmental agency, stormwater banking is used by Delaware for non-bridge construction projects to reduce the inefficient use of small mitigation systems. For example, one large pond may be constructed to mitigate other stormwater sources (highway or urban). The ultimate outcome of stormwater banking and compensating mitigation is the overall reduction of pollutant loads to a watershed. Furthermore, the cost is lower, and the mitigation systems used are typically more effective.

### Filtration Technologies

- **Bio-sorption activated media.** FDOT is working with the University of Central Florida on bio-sorption activated media to absorb nutrients, an approach that is "showing great promise," according to FDOT hydraulics and water quality staff.<sup>140</sup> Bio-sorption Activated Media (BAM) can control nutrients, metals, and bacteria and requires less area to accomplish stormwater management relative to other options.<sup>141</sup> BAM materials have the dual characteristic of sorption properties as well as sites for biological growth.<sup>142</sup> At this point, BAM has residence time issues and limited

<sup>140</sup> Project interview with Amy Tootle and Rich Renna, Florida DOT, December 18, 2012

<sup>141</sup> Martin Wanielista, Ni-Bin Chang, Manoj Chopra et al., Demonstration Project for Bio-sorption Activated Media for Ultra-Urban Stormwater Treatment, submitted to FDOT, May 2012. p. 2

<sup>142</sup> Martin Wanielista, Ni-Bin Chang, Manoj Chopra et al., Demonstration Project for Bio-sorption Activated Media for Ultra-Urban Stormwater Treatment, submitted to FDOT, May 2012. p. 2

ability to handle larger flows, but FDOT notes that “bridge inlets don’t intercept large flow rates. FDOT might use bio-activated media on a bridge deck if the agency is pressed to perform retrofits.”<sup>143</sup> Researchers anticipate being able to raise the flow rate by a factor of four in the next year, for bridge applications.<sup>144</sup> FDOT has already supported research using BAM in retention areas such as swales and pipe-in-pipe wet detention pond harvesting applications.<sup>145</sup> The technology could conceivably be used for ultra-urban environments or instead of a bridge collection system. FDOT would like to see the technology evolve to the point it is “plug and play.”<sup>146</sup> FDOT and university researchers are also performing testing to determine the lifespan of BAM for the removal of both nitrogen and phosphorus compounds and then demonstration projects to document pollutant removal.

- **Pier cap wetland treatment areas.** WSDOT investigated pier cap treatment areas up to the point of testing, which would have cost an additional \$500,000. FHWA funded the first two phases of this research and then decided the idea did not have broad enough appeal. Nevertheless, WSDOT believes this approach, which involves the construction of small wetland treatment area around bridge pier/pile caps, has potential.
- **New product evaluation.** LADOTD and other DOTs noted they continually evaluate new products for consideration and placement on the departments “Qualified Products List.”

## Methods and Tools to Identify and Select Appropriate Mitigation Strategies for Bridge Deck Runoff

### **NCHRP Report 474 Methodologies for Evaluating Need for Mitigation of Bridge Deck Runoff and Kind of Treatment**

NCHRP Project 25-13(01) developed a “practitioner’s” process for DOTs to address whether bridge deck stormwater runoff will affect the receiving water; if runoff does have an impact, whether mitigation is necessary; and if mitigation is necessary, what kind is needed, considering: (1) state and federal regulatory requirements; (2) state and federal regula-

tory agency and interested party concerns with the impact of the bridge—for example, water quality, spills, and endangered species; (3) receiving water characteristics and designated uses, particularly high quality waters and Outstanding National Resource Waters; and (4) bridge deck characteristics.<sup>147</sup> When combined, these factors underscore the point of many of the DOTs interviewed for NCHRP Project 25-42: that consideration of bridge deck runoff was considered and negotiated on a case by case basis, because every bridge and deck discharge condition and multiple uses of a receiving water is unique. The NCHRP Project 25-13(01) practitioner’s guide reports the conclusion that:<sup>148</sup>

Low-traffic rural highways do not cause significant adverse effects on aquatic biota . . . Similarly; many highway agencies do not oppose avoiding direct discharge of stormwater to receiving waters in cases in which bridges are small enough or conveniently enough configured for that to be accomplished at a reasonable cost and without compromising public safety. Again, the research team does not propose that the process described here should supersede such rational, commonsense approaches, nor should it cause the practitioner to employ a more complicated process than necessary to come to a judgment.

NCHRP Project 25-13(01) developed 19 general methodologies for bridge deck runoff analysis and mitigation, which are summarized in Appendix A-3. Method 13: Nonstructural and Structural BMP Evaluation (has been determined that some type of BMP may need to be implemented for bridge deck runoff) is more relevant to the current discussion and thus is described in more detail here. Precursor methods to determine if mitigation is necessary (e.g., calculation of pollutant concentrations at zone of initial dilution, bio-criteria, sediment pollution accumulation model, loading analysis, in situ toxicity testing, comparison to other source loadings in the watershed) are described in Appendix A-3. As NCHRP Project 25-13 points out, “nonstructural, structural, or institutional BMP approaches, or a combination thereof, could be implemented.”<sup>149</sup>

Many factors must be considered in selecting a BMP approach, including the BMP capabilities and limitations, appropriateness for the site, pollutant loading benefits, maintenance requirements, and cost. Safety is also a factor. For example, snoopers will be used to maintain below deck piping, and a confined space entry will be required to maintain piping that is located within the bridge deck structure.

<sup>143</sup> Project interview with Amy Tootle and Rich Renna, Florida DOT, December 18, 2012

<sup>144</sup> Project interview, Dr. Martin P. Wanielista, P. E., January 31, 2013

<sup>145</sup> FDOT research project BDK78 977-02

<sup>146</sup> Project interview with Amy Tootle and Rich Renna, Florida DOT, December 18, 2012

<sup>147</sup> Dupuis, T. V., Pilgrim, K., Mischuk, M., Strum, M., Abere, D., and Bills, G., Research Results Digest 235: Assessment of Impacts of Bridge Deck Runoff Contaminants on Receiving Waters. Transportation Research Board, National Research Council, Washington, DC (January 1999)

<sup>148</sup> Dupuis, T., National Cooperative Highway Research Program (NCHRP) Report 474: Assessing the Impacts of Bridge Deck Runoff Contaminants in Receiving Waters, Volume 2, Practitioner’s Guide, p. 3

<sup>149</sup> NCHRP Report 474, Vol. 2, p. 23, 69



The final report, published as *NCHRP Report 474*, advocates that, “Nonstructural mitigation techniques should always be considered before structural measures because they are cost-effective and sometimes more efficient pollutant removers.”<sup>150</sup> The practitioner’s guide provides a simplified evaluation process to lead the practitioner through the BMP selection process.<sup>151</sup> Further information is available in the *NCHRP Report 474, Volumes 1 and 2* (see also Figure A-1).<sup>152</sup>

- *Step 1.* Define the need (e.g., heavy metals concentration reduction, discharge elimination).
- *Step 2.* Define the constraints (e.g., site, cost, and organizational and physical constraints).
- *Step 3.* Eliminate obviously inappropriate techniques (e.g., if the concern is hazardous material spills only, street sweeping will not address the concern).
- *Step 4.* Begin evaluation of nonstructural BMPs. One by one, determine the benefit and cost of each technique and answer the following: Will the technique achieve the required water quality benefit in whole or in part? Project benefits are based on projected pollutant reduction and/or projected flow reduction. Determine costs for BMPs using literature values or other internal estimates. Nonstructural BMPs that are potentially applicable to bridges include:
  - Street sweeping
  - Inlet box/catch basin maintenance
  - Maintenance management
  - Deicing controls
  - Traffic management (e.g., high occupancy vehicle lanes, and mass transit).
- *Step 5.* If one or a combination of several nonstructural BMPs would not achieve the required benefits, begin evaluation of institutional BMPs (i.e., pollutant trading and mitigation banking). Evaluate whether either of these techniques, or a combination of any techniques evaluated up to this point, would achieve the desired water quality benefit. Determine costs of the institutional BMPs.
- *Step 6.* If the nonstructural and institutional BMPs cannot provide the desired water quality benefit/protection, structural BMPs should be evaluated to determine which methods are appropriate and to assess the cost-effectiveness of potential methods. A critical component of the BMP analysis includes engineering evaluations related to the type of drainage and stormwater conveyance needed, and the effects these systems could have on the structural design of the bridge. In selecting an appropriate BMP, required pollutant removal benefits, site constraints, maintenance constraints, and potential environmental or aes-

thetic enhancements need to be considered (Dorman et al. 1996; Shoemaker et al. 2000; Young et al. 1996, Table 33). Once a narrowed list of BMPs is selected, the costs for each should be calculated and an appropriate economic analysis made (Brown and Schueler 1997). Appropriate BMPs may include simple drainage back to land for relatively small bridges in cases in which this is practical. In most cases, the drainage would be to a grassy area or pond prior to discharge to the receiving water.

NCHRP Project 25-13 advises the practitioner to, “determine if pollutant trading, off-site mitigation, and mitigation banking exist in the appropriate geographic context (i.e., usually within the watershed) of the bridge project. If none exist, it may be beneficial to consider establishing one . . .”<sup>153</sup> Gathering such information places the bridge runoff in context. The loading from the bridge can be estimated by modeling pollutant loads or collection of site-specific runoff quality data (*NCHRP Report 474* v. 2 Methods 11 and 12). Ideally, information on the watershed and waterway can be ascertained from the resource or regulatory agency. EPA’s “How’s My Waterway” website and application (<http://www.epa.gov/mywaterway>) uses GPS technology or a user-entered zip code or city name to provide information about the quality of local water bodies, including the water’s status and the type of pollution reported for that waterway, as well as what states and EPA have done to reduce pollution. Additional reports and technical information is available for many waterways.<sup>154</sup>

Dupuis et al., recommend using these and other watershed specific information from USGS (see WATERS, ATTAINS, and the National Atlas of Sustainability—“Atlas”). If needed, more in-depth modeling can draw on EPA’s Better Assessment Science Integrating point and Nonpoint Sources (BASINS) modeling framework (<http://www.epa.gov/ost/water/BASINS/>). BASINS is a multipurpose environmental analysis system designed for use by regional, state, and local agencies in performing watershed and water quality-based studies. Geographic information supports analysis of a variety of pollutants at multiple scales and point and nonpoint pollution management. The web-based BASINS enables watershed and water quality analyses drawing on national databases; evaluation tools for evaluating water quality and point source loadings at a variety of scales; utilities including local data import, land use and DEM reclassification, watershed delineation, and management of water quality observation data; watershed and water quality models including PLOAD, NPSM (HSPF), SWAT, TOXIRoute, and QUAL2E; and post-processing output tools for interpreting

<sup>150</sup> NCHRP Report 474, Vol. 2, p. 67

<sup>151</sup> NCHRP Report 474, Vol. 2, pp. 69–70

<sup>152</sup> NCHRP Report 474, Vol. 2, pp. 69–70

<sup>153</sup> NCHRP Report 474, Vol. 2, p. 67

<sup>154</sup> USEPA, “How’s My Waterway,” <http://www.epa.gov/mywaterway>



**Process Drivers**

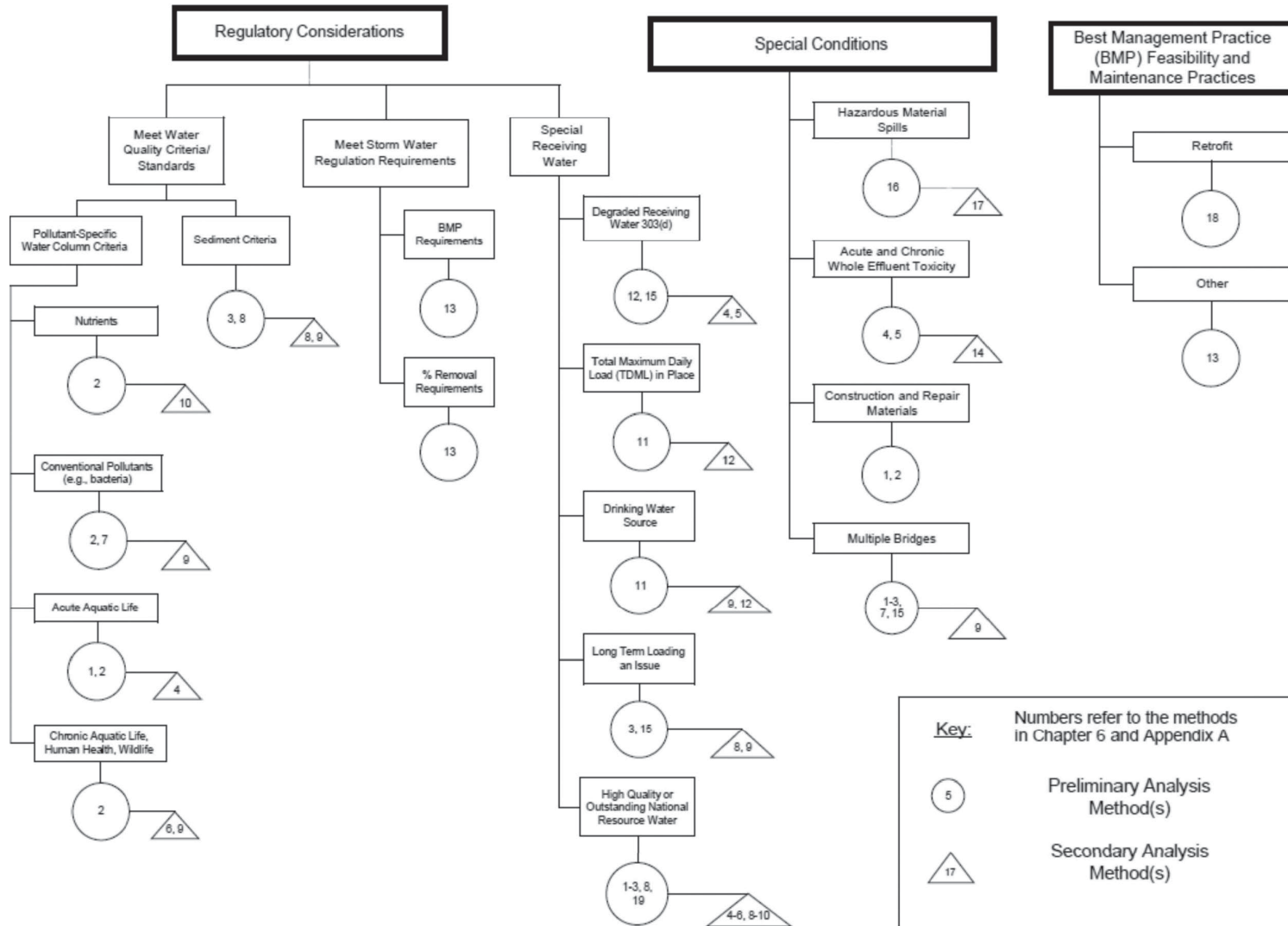

Figure A-1. Process drivers and treatment identification: NCHRP Report 474, bridge deck runoff practitioner's guide.

model results.<sup>155</sup> BASINS has an open-source MapWindow GIS interface, a Data Download Tool, project builder, watershed delineation routines, and data analysis and model output visualization tools as well as plug-in interfaces for well-known watershed and water quality models SWMM5, WASP7, and SWAT 2005. It includes a data extractor, projector, project builder, GIS interface, various GIS-based tools, a series of models, and custom databases; a web data extractor provides a tool for dynamic downloading of GIS data and databases from the BASINS web site and a variety of other sources.<sup>156</sup>

The user specifies a geographic area of interest and the software downloads appropriate data from EPA, USGS and other locations on the Internet. After the GIS data are downloaded, they are automatically extracted, projected to the user specified map projection, and a project file (“*.apr*” for ArcView/BASINS 3.1 and “*.mwprj*” for MapWindow/BASINS 4.0) is built. This Web Data Download tool then allows the user to add additional data to the BASINS project from a variety of data sources, and to check for more recent data and updates as appropriate. The Automated Geospatial Watershed Assessment (AGWA) tool features the USDA-ARS models KINEROS and SWAT. The Kinematic Runoff and Erosion Model (KINEROS) is an event oriented, physically based model that may be used to determine the effects of various artificial features such as urban developments, small detention reservoirs, or lined channels on flood hydrographs and sediment yield. Rosgen’s Bank Erosion Hazard Index has been incorporated in the pollutant loading model as PLOAD-BEHI; this model is useful for simplified analyses of sediment issues. AQUATOX receives and automatically formats output from HSPF or SWAT in order to integrate watershed analysis with the likely effects on the aquatic biota in receiving waters. The new Parameter Estimation (PEST) tool in WinHSPF automates the model calibration process and allows users to quantify the uncertainty associated with specific model predictions.

Considerable guidance exists on BMP selection as noted in the NCHRP Project 25-40 literature review.<sup>157</sup> Available resources include the BMP database, online at <http://www.bmpdatabase.org> with BMP performance data, cost data, BMP monitoring guidance, and protocols for BMP performance assessment and the proprietary BMP performance data more uniquely accessible through the Massachusetts Stormwater Evaluation Project (MASTEP) at <http://www.mastep.net>. BMP selection and design strategies are discussed in Strecker et al. (2000),<sup>158</sup> for work conducted in the evalua-

tion and testing of monitoring equipment and strategies for highway runoff for the FHWA. Other guidance documents including Strecker et al. (2005) and NCHRP (2006) provide general guidance on BMP selection and design.<sup>159</sup> Most state DOTs or state environment agencies have developed catalogs and/or fact sheets of treatment BMPs, such as those included in the AASHTO Compendium of Environmental Stewardship Practices (2004) and guidance and manuals issued by Caltrans, WSDOT, and NCDOT, with information on BMP performance, cost, space requirement, suitability, and/or maintenance requirements that can be useful selecting BMPs.<sup>160</sup>

Typically, no single answer exists to the question of which BMP (or BMPs) should be selected for a site; there are usually multiple solutions ranging from standalone BMPs to treatment trains of multiple BMPs to achieve the water quality objectives within physical site constraints. The first step in BMP selection is identification of physical characteristics of a site including topography, soils, contributing drainage area, groundwater, base flows, wetlands, existing drainage ways, and development conditions in the tributary watershed (e.g., construction activity).<sup>161</sup> DOTs use physical variables (slope, area, velocity) to select and prioritize potential BMPs, in the design process. As the Denver Urban Drainage and Flood Control District notes:<sup>162</sup>

Maintenance should be considered early in the planning and design phase. Even when BMPs are thoughtfully designed and properly installed, they can become eyesores, breed mosquitoes, and cease to function if not properly maintained. BMPs can be more effectively maintained when they are designed to allow easy access for inspection and maintenance and to take into consideration factors such as property ownership, easements, visibility from easily accessible points, slope, vehicle access, and other factors . . . Costs are a fundamental consideration for BMP selection, but often the evaluation of costs during planning and design phases of a project focuses narrowly on up-front, capital costs. A more holistic evaluation of life-cycle costs including operation, maintenance and rehabilitation is prudent . . .

Designers are advised to “fully consider how and with what equipment BMPs will be maintained in the future” and

<sup>155</sup> NCHRP Report 474, Vol. 2, p. 77

<sup>156</sup> USEPA Basins website, Better Assessment Science Integrating point and Non-point Sources, <http://water.epa.gov/scitech/datait/models/basins/basinsv3.cfm>

<sup>157</sup> NCHRP 25-40 Interim Report (Literature Review Results), June 2012.

<sup>158</sup> Strecker, E. W., Mayo, L., Quigley, M. M., and J. Howell (2000) Guidance Manual for Monitoring Highway Runoff Water Quality. Federal Highway Administration, Unpublished Draft, Contract DTFH651-94-C-00108. FHWA (August 2001). Urban Drainage Design Manual, Hydraulic Engineering Circular No. 22, Second Edition, prepared by S. A. Brown, S. M. Stein, and J. C. Warner. Federal Highway Administration, Washington, D.C.

<sup>159</sup> Strecker, E. W., W.C. Huber, J. P. Heaney, D. Bodine, J. J. Sansalone, M. M. Quigley, D. Pankani, M. Leisenring, and P. Thayumanavan (2005). Critical Assessment of Stormwater Treatment and Control Selection Issues, Water Environment Research Foundation (WERF); Report No. 02-SW-1. ISBN 1-84339-741-2. 290p.

<sup>160</sup> Venner, M., Compendium of Environmental Stewardship Practices in Construction and Maintenance, AASHTO, 2004. NCHRP 25-25/04, maintained online at AASHTO’s Center for Environmental Excellence.

<sup>161</sup> Urban Drainage and Flood Control District, Urban Storm Drainage Criteria Manual Volume 3, August 2011 <http://www.udfcd.org/downloads/pdf/critmanual/Volume%203%20PDFs/USDCM%20Volume%203.pdf>, p. 2-13.

<sup>162</sup> Urban Drainage and Flood Control District, Urban Storm Drainage Criteria Manual Volume 3, August 2011 <http://www.udfcd.org/downloads/pdf/critmanual/Volume%203%20PDFs/USDCM%20Volume%203.pdf>, p. 2-13

acquire “clear, legally binding written agreements assigning maintenance responsibilities and committing adequate funds for maintenance.”

Sustainability of performance over time is a design consideration, whether the amount of supplemental irrigation required for the chosen vegetation or clogging of infiltration BMPs when there is upstream development. Design of BMPs must be informed by operation and maintenance performance in the field.

### **NCHRP Report 565 on BMP Selection**

*NCHRP Report 565* advocated the practice of considering BMP unit operations (i.e., treatment mechanisms or processes) in the design and selection of structural BMPs and BMP treatment trains. Physical processes, such as sedimentation and filtration, can be used to remove a significant portion of the pollutant load when a pollutant is predominately particulate bound. However, more complex chemical and biological unit operations may be required to treat pollutants that are dissolved or readily change from within the aqueous environment as a function of redox, pH, and available partitioning sites (i.e., solids load or media characteristics).<sup>163</sup>

Historically, BMP selection and comparison involved calculating pollutant removal efficiencies, or the ratio of effluent concentration to influent concentration expressed as a percentage; however, Geosyntec noted that this concept of “effectiveness” has key shortcomings:<sup>164</sup>

- Pollutant removal efficiencies for many BMPs that remove and sequester pollutants are largely a function of the influent stormwater pollutant profile (Wright Water Engineers and Geosyntec Consultants 2007; CASQA 2003; USEPA 2009b). Since influent stormwater conditions can be site specific and are rarely verified by monitoring, using this criteria alone as an estimate of effectiveness may not be appropriate.
- Comparing pollutant removal of BMPs that use volume reduction as the primary unit operation (e.g., infiltration basins) to BMPs that promote sedimentation or filtration can be difficult, since volume reduction BMPs remove a portion of the pollution load instead of reducing the concentration.
- BMPs that provide diffuse flow or otherwise prevent erosion have the potential to provide a widespread water quality benefit, but their effectiveness is not easily benchmarked against other BMPs. It can be complicated to quantitatively

compare the theoretical load prevented (e.g., erosion prevented by riprap in the bridge overbank) to the theoretical load removed (e.g., solids removed in a dry detention basin).

Current research focuses on developing procedures for selecting BMPs based on compiled irreducible concentrations and well-defined receiving stream goals (such as benthic macroinvertebrate health ratings).<sup>165</sup> Until widely accepted procedures exist for identifying effective BMPs based on a distribution of effluent concentrations proven to protect receiving stream quality, many regulatory agencies require BMPs based on surrogate strategies including mandating certain BMP types under certain circumstances, providing assumed pollutant removal credits for BMPs based on type, and assumed surface water quality protection for a suite of BMPs specific to certain receiving stream classifications or sensitive watersheds.<sup>166</sup>

### **DOT Mitigation Methods and BMP Selection Strategies**

Most DOTs contacted for this study said that they have not developed methods or tools to identify and select mitigation strategies for bridge deck runoff. DOTs concurred that the primary challenge was getting the water off the bridge for treatment; a number of DOTs said that a wide range of conventional stormwater treatment BMPs would be considered once flow is conveyed to the abutment area.

### **Selection Processes and Matrices for Traditional Roadside Post-Construction BMPs**

Selection processes and matrices for general roadside post-construction BMPs are not uncommon at DOTs. An example selection matrix from MassDOT is included in Attachment A-1. Likewise, Arizona DOT’s Post-Construction BMP Manual has matrices for the following evaluation by BMP type:

Site Specific Considerations:

- Area typically served (acres)
- Percent of site area required for BMP (%)
- Configuration
- Soils
- Minimum hydraulic head (ft)
- Maximum upstream slopes (%)

<sup>163</sup> OSU et al., Evaluation of Best Management Practices for Highway Runoff Control, NCHRP Report 565, 2006

<sup>164</sup> OSU et al., Evaluation of Best Management Practices for Highway Runoff Control, NCHRP Report 565, 2006

<sup>165</sup> McNett et al., 2010 cited in NCDOT/URS, 2010

<sup>166</sup> NCDENR, 2009; NRC, 2008. cited in NCDOT/URS, 2010

- Fracturing geology present
- Minimum depth to groundwater
- Approximate percent (%) removal efficiencies for select parameters
- Safety reference(s)

### Environmental Stewardship Considerations

- Urban areas
- Setback requirements
- Streambank erosion
- Sensitive water bodies
- Sensitive wildlife habitats
- References

### Climatic Zone Restrictions

- Peak flow reduction
- Temperature extremes (cold climate, arid semi-arid climates)

Georgia DOT's Stormwater Management Manual outlines a similar screening process to assist the site designer and design engineer in BMP selection. Georgia DOT considers the following factors, in order:

- **Stormwater Treatment Suitability:** Capability to provide water quality treatment, downstream channel protection, overbank flood protection, and extreme flood protection).
- **Water Quality Performance:** Ability to accept hotspot runoff and provide TSS, nutrient and/or bacteria removal).
- **Site Applicability:** Drainage area, space required (space consumed), slope, minimum head (elevation difference from inflow to outflow—particularly important in the case of bridges), and water table.
- **Implementation Considerations:** Including construction cost and maintenance level of effort are considered.

Since watershed considerations are not seen as often in these matrices and since *NCHRP Report 474* advocates watershed level context analysis for consideration of tradeoffs, Georgia DOT's table for watershed considerations is included in Table A-2.

Georgia DOT's matrices for each of the above are summarized in a final matrix in Table A-3.

### Interviewed States Point to Case-by-Case, Negotiated Mitigation Strategies

The DOTs interviewed for NCHRP Project 25-42 did not have bridge deck runoff specific BMP selection matrices. Rather, resource agency requirements tended to guide and to instigate design for treatment of bridge deck runoff. Florida

DOT said their BMP/mitigation selection tool consisted of a simple four step process:

1. Drain it off the bridge and get it to a collection system.
2. Direct discharge
3. Compensatory treatment
4. Last choice: collection system using fiberglass pipe.

WSDOT's stormwater management plan contains a prioritization process for where the agency will do retrofits, taking into account sensitive areas and where the agencies can achieve the greatest benefit. Every project must evaluate whether they are triggering minimum requirements. NCDOT's "Merger Process" with state and federal resource agencies targets natural resource mitigation to places in the watershed where they will accomplish the greatest environmental good:<sup>167</sup>

The Merger Process allows for a site-specific stormwater control measure (SCM/BMP) selection process to address the environmental concerns of the various agencies. Site-specific goals for stormwater control measures (SCM) should be based on regional water resource management strategies and should be linked to the designated uses and water quality standards of receiving waters (National Research Council 2008). However, linking stormwater discharges from bridges to receiving water effects can be difficult. Future efforts should continue to develop a process that more closely links stormwater discharges from bridges to receiving water effects and bases SCM selection on their effectiveness.

Both TxDOT and LADOTD commented that mitigation strategies and/or BMPs are primarily driven by environmental regulations such as permits, administrative orders, etc., with consideration of the sensitivity of the water body. Even North Carolina, which has arguably invested the most in an analytical approach for bridge deck runoff treatment, stressed that they identify and select appropriate mitigation strategies for bridge deck runoff on a case by case basis, in a negotiated fashion.<sup>168</sup> URS concluded:<sup>169</sup>

As more is known about the relationship between pollutant generation, BMP function, and receiving stream effects, stormwater management programs can be developed that select BMPs based on more definitive effectiveness criteria. Using the best available information collected at this time, **quantitatively determining the ability of a BMP included in this study to meet receiving stream or water quality objectives, and thus determine its effectiveness, is not feasible.** Since determination of site-specific water

<sup>167</sup> NCDOT/URS p. 8-2

<sup>168</sup> Project interview with Matt Lauffer and Kathy Herring, NCDOT, and Michelle Mayfield, Alex Nice (URS Corp), and Chad Wagner, USGS, December 20, 2012

<sup>169</sup> NCDOT/URS, 2010, p. 6-2



**Table A-2. Georgia DOT physiographic and watershed considerations for BMPs.**

STRUCTURAL CONTROL CATEGORY	PHYSIOGRAPHIC FACTORS			SOILS	SPECIAL WATERSHED CONSIDERATIONS				
	Low Relief	High Relief	Karst		Trout Stream	High Quality Stream	Aquifer Protection	Reservoir Protection	Shellfish / Beach
<b>Stormwater Ponds</b>	Limit maximum normal pool depth to about 4 feet (dugout)  Providing pond drain can be problematic	Embankment heights restricted	Require poly or clay liner  Max ponding depth  Geotechnical tests	"A" soils may require pond liner  "B" soils may require infiltration testing	Limit use of due to thermal impacts  Limit ED to 12 hrs  Offline design and provide shading	Evaluate for stream warming	May require liner if "A" soils are present  Pretreat hotspots  2 to 4 ft separation distance from water table		Moderate bacteria removal  Design for waterfowl prevention  Provide 48 hr ED for max coliform dieoff
<b>Stormwater Wetlands</b>		Embankment Heights restricted	Require poly-liner  Geotechnical tests	"A" soils may require pond liner	Limit use of due to thermal impacts  Offline design and provide shading	Evaluate for stream warming	May require liner if "A" soils are present  Pretreat hotspots  2 to 4 ft separation distance from water table		Provide 48 hr ED for max coliform dieoff
<b>Bioretention &amp; Sand Filters</b>	Several design variations will likely be limited by low head		Use poly-liner or impermeable membrane to seal bottom	Clay or silty soils may require pretreatment	Evaluate for stream warming	Evaluate for stream warming	Needs to be designed with no exfiltration (i.e. outflow to groundwater)		Moderate to high coliform removal
<b>Infiltration</b>	Minimum distance to water table of 2 feet	Maximum slope of 6%  Trenches must have flat bottom	GENERALLY NOT ALLOWED	Infiltration rate > 0.5 inch/hr			Maintain safe distance from wells and water table  No hotspot runoff	Maintain safe distance from bedrock and water table  Pretreat runoff	Maintain safe distance from water table
<b>Enhanced Swales</b>	Generally feasible however slope <1% may lead to standing water in dry swales	Often infeasible if slopes are 4% or greater					Hotspot runoff must be adequately treated	Hotspot runoff must be adequately treated	Poor coliform removal

quality goals is also not feasible without extensive studies, the (team) relied upon existing water quality regulations established by NCDENR to define sensitive receiving waters. Thus, the assumption of effectiveness for a BMP type is determined by its ability to be applied to a specific location discharging to a sensitive stream as defined by NCDENR's water quality regulations (emphasis added).

NCDOT stresses that the process of determining a BMP's effectiveness for a particular bridge or roadway project is not straightforward, for several reasons:<sup>170</sup>

- It is generally not possible to identify site-specific pollutants-of-concern (POCs) at each bridge or roadway project. Because many of the storm event characteristics that influ-

ence pollutant load are related to variable and unpredictable precipitation attributes (intensity, duration, antecedent dry periods), properly characterizing stormwater runoff at a site requires a monitoring program that captures a number of storm events. This sort of monitoring is time and cost intensive and is not feasible at every project site.

- Even when monitoring data is available, it can be difficult to understand the significance of the magnitude of POC concentrations. The relationship between end-of-pipe concentrations of typical POCs and the degree of resulting impact on a receiving stream is poorly understood (Burton and Pitt 2002). For example, many of the identified POCs in this study had concentrations elevated above surface water quality thresholds, but no expression of toxicity was identified for concurrent bioassays. Exceedances of thresholds do not necessarily signify that BMPs are needed to protect water quality.

<sup>170</sup>NCDOT/URS. Stormwater Runoff from Bridges, Final Report, July 2010, p. 6-2

**Table A-3. Georgia DOT general application structural control alternatives for BMPs.**

General Application Structural Control Alternative	Stormwater Treatment Suitability	Site Applicability	Implementation Considerations	Physiographic Factors/Soils	Special Watershed Considerations	Other Issues
Wet Pond	✓	X				
Wet ED Pond	✓	X				
Micropool ED Pond	✓	✓	✓	✓	none	
Multiple Ponds	✓	X				
Shallow Wetland	✓	X				
ED Shallow Wetland	✓	X				
Pocket Wetland	✓	✓	✓	✓	none	Odor / mosquitoes
Infiltration Trench	✓ <sup>1</sup>	✓	✓	X		
Surface Sand Filter	✓ <sup>1</sup>	✓ <sup>2</sup>	✓	✓	none	Aesthetics
Perimeter SF	✓ <sup>1</sup>	✓ <sup>2</sup>	✓	✓	none	Higher cost
Bioretention	✓ <sup>1</sup>	✓ <sup>2</sup>	✓	✓	none	
Dry Swale	✓ <sup>1</sup>	✓ <sup>2</sup>	✓	✓	none	
Wet Swale	✓ <sup>1</sup>	✓ <sup>2</sup>	✓	✓	none	Odor / mosquitoes

Notes:

1. Only when used with another structural control that provides water quantity control
2. Can treat a portion of the site

- BMPs are not typically selected based on identified POCs (see first bullet) and are still widely evaluated based on pollutant removal efficiency and not the irreducible concentration, as is recommended in the International Stormwater BMP Database (Wright Water Engineers and Geosyntec Consultants, 2007). As previously discussed, pollutant removal efficiency is largely a function of influent concentration. Because site-specific POCs are generally not identified, nor their typical concentrations known, pollutant removal efficiencies do not provide useful information for determining concentrations reduced or mass load removed for a particular POC. Further, discussions of BMP pollutant removal efficiency or effectiveness without understanding project-specific water quality goals does not provide useful information on BMP performance.
- For impaired receiving streams that have been subject to a TMDL where a particular load reduction target has been established, the load reductions are provided in terms of an annual mass load reduction. However, because it is generally difficult to predict the annual mass load removed from a BMP without knowing (1) the influent pollutant profile, (2) typical effluent concentrations from the BMP, and (3) hydrologic characteristics that determine flow

rates and volume in advance, it is difficult to accurately select BMPs that can effectively meet TMDL requirements.

NCDOT decided that Stormwater Management Plans would be required for all new location and replacement bridge projects.<sup>171</sup>

- Level I treatment BMPs discussed in the NCDOT treatment report were recommended to be implemented on projects under certain conditions:
  - The bridge project crosses a water body on the 303(d) list as maintained by NCDENR.
  - The bridge project is located in a TMDL area; treatment requirements will be determined in accordance with Part III, Section C of NCDOT’s NDPES permit (see discussion in section 6.3).
  - The bridge project is located in an endangered species area and through biological assessments, the U.S. Fish and Wildlife Service (USFWS) has rendered a biological opinion that a Level I treatment BMP is required to mitigate potential impacts.

<sup>171</sup> NCDOT/URS, 6-22 and 6-23

- The bridge project is located as part of a roadway with anticipated average daily traffic greater than 30,000 vehicles per day.
- The bridge project is a new location bridge and located in a water quality sensitive area.
- The bridge project is a replacement bridge that is widened more than one travel lane and located in a water quality sensitive area.
- Requiring BMPs on projects with an anticipated average daily traffic of 30,000 vehicles per day or higher is not currently included as part of NCDOT's post-construction stormwater program (PCSP). However, NCDOT does currently focus retrofit implementation in areas where facilities cross sensitive streams with high ADT loads (NCDOT 2008b). This ADT split of 30,000 vehicles per day originates from an FHWA study that showed roadway sites with ADTs higher than this benchmark had higher stormwater pollutant loads than lower ADT sites (FHWA 1990). The researchers theorized that ADT did not directly affect pollutant loads, but might be an indicator of atmospheric quality differences between urban and rural land uses. In addition, ADT is currently used to determine BMP treatment requirements for other departments of transportation (WSDOT 2008). The use of ADT as an indicator of pollutant load is still being evaluated in the literature, and statistical analysis of provisional bridge runoff data suggests that a roadway site's urban or rural classification per the FHWA Functional Classification Guidelines may be a more appropriate indicator of pollutant load. For the purposes of developing a statewide BMP cost-estimate, the use of ADT to determine BMP needs is an appropriate estimating tool. However, the use of ADT as a trigger for BMP treatment on a project-by-project basis should be investigated further before being incorporated into the PCSP for all types of transportation runoff.
- Level II treatment BMPs will be implemented on all projects.
- Maintenance BMP will be implemented for all projects following construction and concurrent with routine bridge maintenance activities.
- Bridge sweeping (Maintenance BMP) will continue to be implemented as appropriate (further investigations on implementation for water quality preservation and protection are needed).
- Design-related BMPs will be implemented as appropriate to support the no-direct discharge policy or stormwater mitigation.

NCDOT's 2010 report states that:

For bridges where water quality of bridge deck runoff may not be a concern, use of scupper drains to disperse runoff over a

large area could be a significant cost savings when compared to implementation of deck conveyance or collection systems (installed to support NCDOT's no-direct discharge policy); these savings could be significant for long coastal bridges and, if combined with off-site stormwater mitigation, could result in a more effective water quality benefit. NCDOT should complete investigations into the applicability of dispersion of bridge deck runoff, including developing with DWQ a specific bridge criteria where dispersion of bridge deck runoff is an acceptable practice and assessing the effects on overbank areas, wetlands, and receiving waters.<sup>172</sup>

This process represents an evolution of the primary requirements outlined in Chapter 9 of NCDOT's Stormwater BMP Toolbox and no-direct discharge policy (2002), summarized as follows:<sup>173</sup>

- Bridges crossing streams within river basins with buffer rules shall not have deck drains that discharge directly into the water body or buffer zones; deck drains may discharge into the buffer zone if 12 feet above natural ground.
- Bridges over sounds or water bodies of the Intracoastal Waterway may be allowed to discharge directly into receiving waters because the volume of stormwater runoff from deck drains is small relative to the volume of the water bodies and sites for effective treatment are scarce, unless advised otherwise by the regulatory agencies. As most of these bridges facilitate boat passage, the bridge height and winds help disperse stormwater from the bridges.
- For bridges over other waters (perennial or tidal streams), direct discharge into the water body should be avoided to the maximum extent practicable (MEP). In addition, discharge from deck drains in over bank areas similar to stream buffer areas should be avoided.
- Where closed systems are utilized to achieve no-direct discharge, the discharge point shall be as far away from the surface water body as practical. Preformed scour holes or other devices were recommended to promote diffuse flow.

NCDOT has been implementing these policies for new bridges as well as replacement bridges throughout the state since 2002. No-direct discharge is typically achieved through widening of the bridge to accommodate stormwater flow (deck conveyance) or through the use of closed systems. NCDOT has ongoing research on the performance of PFC pavements, bioretention cells, grassed swales, and environmental site design. This research will evaluate irreducible concentrations and removal of dissolved metals and other parameters-of-concern identified in this study.

<sup>172</sup>NCDOT, 2-10-2-11

<sup>173</sup>NCDOT/URS, p. 6-21

# Methods to Identify an Appropriate Whole Life Cost-Benefit Strategy for Bridge Deck Runoff Mitigation

As of December 2012 there were 607,380 bridges in the United States as defined within 23 CFR 650 Subpart C.<sup>174</sup> Of those, 504,563 are listed as crossing some type of waterway.<sup>175</sup> With this number of bridges to maintain and state and federal budgets as they are, funds must be directed to where they will produce a tangible and worthwhile benefit. Management of bridge deck runoff water quality requires practical solutions, which are easy to retrofit to existing infrastructure, maintainable by DOTs using existing personnel, equipment and techniques, and which will have the lowest possible whole-life cost.

## State DOT Methods

MDSHA's programmatic approach ensures that the agency can cost-effectively respond to the need for treatment by extending treatment in the highest priority areas, usually not at a bridge deck. FDOT ensures consideration of cost by following their tier of preferences for (1) runoff drainage off bridge, (2) direct discharge, (3) compensatory treatment, and (4) collection system and piping.

WSDOT's State Stormwater Strategy includes a prioritization equation to guide their BMP retrofit program. Additional details are available in WSDOT's permit. This approach may be most accessible in Alaska DOT & PF's Bridge Deck Runoff study, which contains descriptive summaries of (scoring within) each element of the equation:<sup>176</sup>

$$\text{P-Score} = (A + B) + (C1 * D) + C2 \\ + [(E1 + E2 + E3 + E4) * E5] + E6 + F.$$

Where:

- A = Type and size of receiving water body.
- B = Beneficial uses of receiving water body.
- C = Pollutant loading.
- D = Percentage contribution of highway runoff to watershed.
- E = Cost/pollution benefit.
- F = Values trade-off.

Alaska DOT started with a stormwater outfall prioritization system WSDOT developed, which compares the impacts of one outfall with another and makes an assessment of their overall impacts to determine cases in which retrofitting is warranted. The Alaska DOT adds factors from the ACWA, STIP, and several other Alaskan environmental parameters, to indicate bridges where the impacts of bridge deck runoff on the receiving water should be considered. When considering the benefits of constructing a new BMP or modifications to existing BMPs, the weight can be given to the bridges with highest prioritization score, called their "Modified P-score," which is formulated as follows:<sup>177</sup>

$$\text{M P-score} = \text{P score} + P + S + T + V + W + X$$

Where:<sup>178</sup>

- P = ADFG score to prioritize some waters over others to protect critical fish bearing resources (High = 5, Medium = 3, Low = 1)
- S = Maximum state priority score given by ACWA. Element shows the waters identified by the ACWA as high priority. Waters are nominated and scored by DF&G, DEC, and DNR state agencies, and factored into the calculation by their highest score from one of these agencies. (High = 5, Medium = 3, Low = 1)
- T = Traffic type. Heavy truck traffic = 1, No heavy trucks = 0
- V = Salty water. To be aware of the biological environment under the bridge in general, a column described the water underneath the bridge as salty or fresh. It is scored as -1, if it is salty water and scored as 1, if it is fresh water.
- W = Silty water. Element identifies whether silty water goes under the bridge. Gathered from the Juneau Department of Transportation as silty/not silty, -1/1.
- X = Dimension of the bridge. The bridges were grouped into three sections depending on their length. If the bridge is longer than 400 ft, it is considered long and scored as 5. If the length is between 200 and 400ft, its score is 3, and if it is less than 200 ft, it is a short bridge, and scored as 1.

Alaska DOT also advanced the following steps to help engineers to make a decision whether a BMP should be considered for a bridge.

- **Is it in Urbanized Area?** Alaska is considering BMPs for all bridges within UAs.
- **Is it in Statewide Transportation Improvement Program (STIP)?** It is less expensive to construct a retrofit BMP

<sup>174</sup> Project interview with Doug Blades, P. E., Structural Engineer, FHWA, Office of Bridge Technology Washington, DC, January 29, 2013

<sup>175</sup> Project interview with Doug Blades, P. E., Structural Engineer, FHWA, Office of Bridge Technology Washington, DC, January 29, 2013

<sup>176</sup> Alaska DOT & PF's Bridge Deck Runoff study, p. 54

<sup>177</sup> Perkins, R., and Hazirbaba, Y., Alaska UTC and DOT & Public Facilities, Bridge Deck Runoff: Water Quality Analysis and BMP Effectiveness, December 2010, pp. 59–60

<sup>178</sup> Perkins, R., and Hazirbaba, Y., Alaska UTC and DOT & Public Facilities, Bridge Deck Runoff: Water Quality Analysis and BMP Effectiveness, December 2010, pp. 62–64



while other construction is underway so if the bridge is in STIP, then BMP options should be considered to handle deck runoff prior to the completion of the project.

- **What is State ACWA (Combined water body sensitivity) Score?** Under ACWA, ADNR, ADFG and ADEC have developed a water body nomination and ranking process. ADNR hydrologists provide factor-ratings for water quantity, whereas biologists in ADFG provide aquatic habitat factor ratings, and ADEC provides water quality ratings. Each water body is assigned a high, medium, or lower priority. This provides a general notion of how “sensitive” a water body is. Criteria include the statutory criteria as well as severity of pollution and uses to be made of the waters, per the Clean Water Act § 303(d) (1)(A). Most waters that are listed as impaired are ranked as high priority in ACWA.
- **Is the bridge over the waters that feed critical habitat (e.g., Cook Inlet)?** The National Marine Fisheries Service proposes to designate a critical habitat under the Endangered Species Act for the Cook Inlet Beluga whale. This would result in all discharges to upper Cook Inlet coming under scrutiny.
- **What is Modified Prioritization Score (PS)?** If a bridge in this analysis gets a very high score, BMP should be considered. If it is low, there may not be any need for a BMP. Most of the bridges that have high modified P scores will require BMP consideration based on one of the four preceding criteria, but a few may not. Here the Alaska DOT will need to set the threshold based on the score. Aside from the threshold, the modified priority score serves as an index of importance of BMP for that bridge and allows relative rankings between bridges.

According to the Alaska DOT’s study, the number of bridges requiring treatment are likely to be as follows:<sup>179</sup>

- In an Urbanized Area: 66 bridges in Anchorage or Fairbanks, or Mat-Su
- In the STIP: 61 additional bridges are slated for construction in the next five years
- A state priority according to resource agencies: 118 additional bridges were give a priority by ADF&G, ADEC, or ADNR, indicating such in the Alaska Clean Water Actions document
- Over waters that feed Cook Inlet: 10 additional bridges in Beluga Whale habitat

About 255 of the state’s 703 bridges should be considered for BMPs based on the defined criteria. For the other bridges, the priority score might indicate it should be evaluated for BMP. In that case, however, the cut off score is not defined by regulation. Using the median score, there would be an additional 10 bridges that should be considered for a BMP. For the remainder, the

<sup>179</sup>Perkins, R., and Hazirbaba, Y., Alaska UTC and DOT & Public Facilities, Bridge Deck Runoff: Water Quality Analysis and BMP Effectiveness, December 2010, pp. 2–6

priority score might indicate a relative ranking, but, absent bridge-specific issues, a BMP is not required.<sup>180</sup> During the planning of these projects, “the priority score can be used to rate the bridge regarding its likely contribution to receiving water contamination. Thus the priority score can aid decision making regarding the likely benefits of any given BMP; that is, less expensive BMPs would be indicated for lower priority scores.”<sup>181</sup>

If a BMP is indicated at the end of the bridge BMP selection process, a checklist for BMP type is presented as follows.

- I. Flow into the river via drains or sides
  - a. Can it be changed to flow to ends?
    - i. Unlikely—major engineering/construction project
    - ii. Perhaps if very short?
  - b. Can it be fitted with pipes to ends or treatment?
    - i. Unlikely—major project
    - ii. Little evidence of success in cold regions
    - iii. Further study
  - c. BMP, non-structural
    - i. Public awareness
    - ii. Trash prevention
    - iii. Deicing changes
    - iv. Street sweeping
    - v. Snow management
    - vi. Melting
- II. Flow to ends
  - a. Non-structural BMP, same as I above
  - b. Structural BMP
    - i. Vegetation
    - ii. Swales
    - iii. Treatment
    - iv. Other

Alaska DOT’s project developed a database of all the state’s bridges and their parameters relevant to stormwater runoff. From those parameters a numerical rating was developed for each bridge. This rating, together with certain regulatory thresholds, is used to determine if BMPs are required. According to Alaska DOT, the best solution for “each bridge is not defined in law, but requires selection by the Alaska DOT after consideration of the bridge characteristics, costs and benefits of candidate BMPs, and practicalities of construction. In general, there are far fewer options for bridge runoff as compared to a standard highway section, and fewer yet that will work in a climate as cold as Alaska. The options can also be quite different for a bridge that is in service versus a bridge that will undergo major repairs or new construction.” Unless the water body is impaired by the bridge runoff—and Alaska

<sup>180</sup>Perkins, R., and Hazirbaba, Y., Alaska UTC and DOT & Public Facilities, Bridge Deck Runoff: Water Quality Analysis and BMP Effectiveness, December 2010, p. 2

<sup>181</sup>Perkins, R., and Hazirbaba, Y., Alaska UTC and DOT & Public Facilities, Bridge Deck Runoff: Water Quality Analysis and BMP Effectiveness, December 2010, p. 3

DOT's project did not find any bridges where that was the case—there are a wide variety of BMPs that might be applied, ranging from low cost items such as public education and review of de-icing practices, to more costly items such as street sweeping or drainage modifications.<sup>182</sup>

When asked about their methods to identify an appropriate cost/benefit strategy for bridge deck runoff mitigation, NCDOT emphasized that “it comes back to a case-by-case situation: what is practical; what can be installed. It's a qualitative assessment. We don't have a generic process in place to evaluate cost-benefit. We evaluate (that) on every project.”<sup>183</sup> NCDOT takes into account the context of the receiving water and anticipated benefit; “in some cases bridge deck discharges are of higher quality than the receiving water,” from their empirical data on mixing in base flow and storm flows.<sup>184</sup>

Interviewed DOTs tended to agree that “investing limited resources to clean relatively clean water [from bridge decks] is not ideal,” though all agencies were committed to complying with laws and regulations. Other DOTs indicated they were not doing any sort of cost-benefit assessment. Two DOTs indicated that they were merely treating bridge deck runoff treatment as an “environmental commitment requirement,” where regulatory agencies made those stipulations (NE, TX). SCDOT indicated that they were evaluating costs. The state DOT's contact at the South Carolina Department of Health and Environment stated that they “worked with SCDOT on what is feasible, practical, and realistic. SCDOT notes that using structures on a bridge can increase the cost tremendously.”<sup>185</sup>

In North Carolina, Section 25.18 (c) of Session Law 2008-107 required NCDOT to determine the costs of each treatment BMP and the costs of implementing effective treatments on new bridge construction projects as well as existing bridge retrofit projects for all bridges over waterways in the state. This information was provided in NCDOT's 2010 report, “Quantifying capital outlays and annual expenditures associated with various SCMs is vital in supporting informed choices by environmental stakeholders during the planning process.”<sup>186</sup>

NCDOT's 2010 guide utilizes BMP effectiveness as a guide, comprised of (1) site-specific water quality goals, and (2) which BMPs are capable of source control or treatment of stormwater runoff from a particular land use; a BMP “is considered effective if it can be reasonably deduced from available evidence that (its) capability for treatment or pollution prevention can provide *cost-effective and sustainable* mitigation for

the effect of stormwater to meet receiving stream or water quality” (emphasis added).<sup>187</sup>

Thus, cost-effectiveness and sustainability/maintainability are central considerations. NCDOT seeks to provide systematic training for designers and engineers associated with selection and implementation of bridge BMPs, considering cost-benefit; the agency's 2010 report calls for:<sup>188</sup>

Additional training for designers and engineers (that) should also include optimal selection and implementation of bridge BMPs (and) should both promote understanding of unit processes for stormwater treatment and encourage value engineering. Measures that promote the most water quality benefit for dollar spent should be emphasized as part of training for designers and engineers, including implementation of environmental site design concepts, design aspects that facilitate construction and maintenance, and others, as deemed appropriate . . .

It is difficult to introduce costs into the equation due to the variability of key factors and also due “to the limited guidance on costing, with several studies only focusing on specific BMPs and in some cases, providing conflicting evidence on unit costs and scale effects.”<sup>189</sup>

Costs for SCMs have been shown to vary widely due to the influence of climate; site conditions; regulatory requirements, such as environmental and labor issues; aesthetic expectations; public versus private funding; and other influences (Lambe et al., 2005). Many studies have focused on establishing construction costs for specific SCM types, based on analysis of historical construction costs of similar projects, or by the development of a bottom-up cost estimate (Wossink and Hunt 2003; Caltrans 2004; Narayana and Pitt 2006). In general, economies of scale have been recognized in observed construction costs for SCMs (Lambe et al. 2005), which could be correlated to a unit size, such as a drainage area (Wossink and Hunt 2003). Cost estimates are generally more reliable when based on local cost information; a common approach is to use engineering estimates to develop an understanding of material and labor requirements and to use local sources for unit cost data (Lambe et al. 2005). It should be noted in the planning process that retrofitting a SCM into an existing site could also involve substantially larger capital outlays than at a new construction site (NRC 2008).

Operating and maintenance costs are a substantial portion as well. As the North Carolina interagency team and consultant URS noted: “There have been relatively few studies into these recurring costs, and relatively little cost information is currently available.”<sup>190</sup> Nevertheless, when the team examined itemized costs within the budgets for the 10 retrofit projects under consideration, they concluded that design costs for BMPs associated with new construction projects were approximately 40% of the design costs for BMP retrofit projects.

<sup>182</sup> Perkins, R., and Hazirbaba, Y., Alaska UTC and DOT & Public Facilities, Bridge Deck Runoff: Water Quality Analysis and BMP Effectiveness, December 2010, p. 1

<sup>183</sup> Eck, Bradley, et al. Water Quality of Drainage from Permeable Friction Course, Journal of Environmental Engineering, ASCE, February 2012, pp. 174

<sup>184</sup> Eck, Bradley, et al. Water Quality of Drainage from Permeable Friction Course, Journal of Environmental Engineering, ASCE, February 2012, pp. 174

<sup>185</sup> Project Interview with Mark A. Giffin, Project Manager, SC Department of Health and Environmental Conservation, Division of Water Quality, January 7, 2013

<sup>186</sup> NCDOT/URS, Stormwater Runoff from Bridges, Final Report to Joint Legislation Transportation Oversight Committee, North Carolina Department of Transportation, 2010

<sup>187</sup> NCDOT/URS, p. 8-4

<sup>188</sup> NCDOT/URS, p. 8-4

<sup>189</sup> NRC, 2008, cited in URS/DOT, p. 7-2

<sup>190</sup> NRC, 2008; Lambe et al., 2005; Wossink and Hunt, 2003). Cited in URS/DOT, p. 7-1

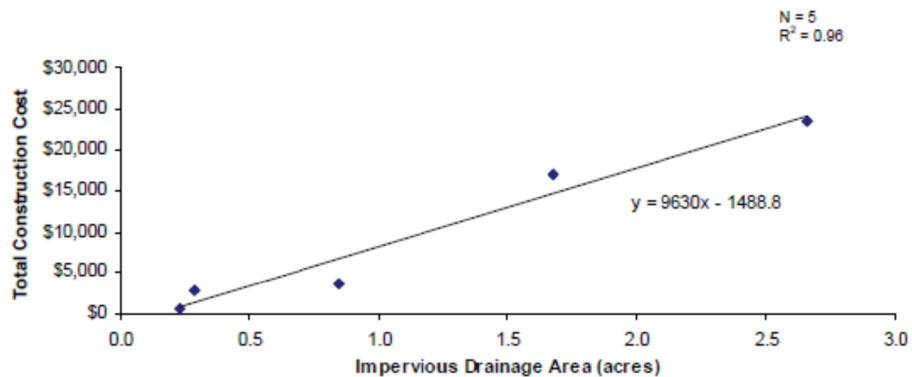

Figure A-2. Comparison of construction cost to impervious drainage area.

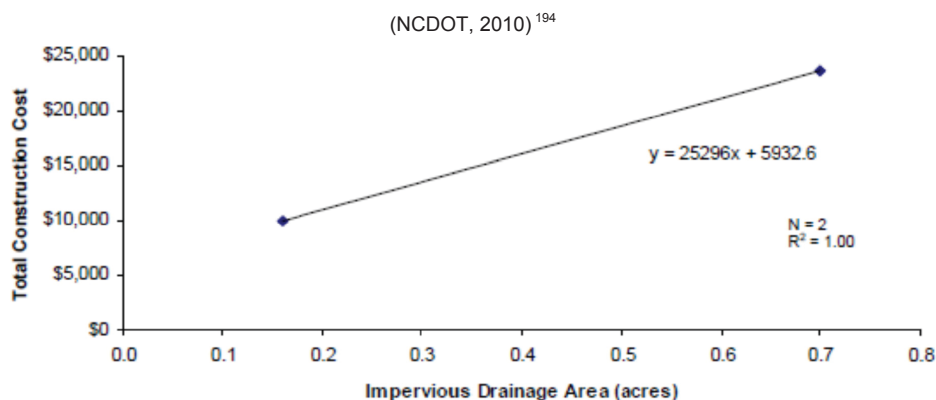

Figure A-3. Arizona DOT BMP construction and maintenance cost data.

NCDOT developed cost estimates for each of 50 pilot study sites to characterize costs for the particular SCMs at each site and to provide an additional means of identifying costs for bridge SCMs; when actual construction costs or preliminary construction estimates were unavailable, some known data, typically impervious drainage area, were used to estimate construction costs.<sup>191</sup> NCDOT described how they calculated operating costs:<sup>192</sup>

Operating costs represent the costs necessary to inspect, operate, and maintain an SCM. Typical operating cost estimates were derived from the following sources (in order of preference): local data and information, regional or national estimates or models, and best engineering judgment where other data was not available. For each SCM type, operating costs reported include the cost of an annual inspection, the costs of routine maintenance, and the costs of infrequent maintenance. A cost of \$100 per annual inspection was assumed based on inspection requirements . . . and estimates from NCDOT SCM inspection units for the cost of time, materials, and equipment required for inspection and reporting. Routine maintenance costs were based on procedures expected to be performed on a regular basis to maintain the proper working order of an SCM, such as vegetation management, trash and debris removal, and minimal grading and repairs.

Infrequent maintenance costs were based on maintenance tasks anticipated to be performed periodically but less frequently than routine maintenance. Examples of infrequent maintenance include accumulated sediment removal; soil media, mulch, and riprap replacement; and larger scale grading and repairs.

Where reported, sweeping costs per linear foot of bridge deck ranged from \$0.80 to \$1.23 per Division swept.<sup>193</sup> The NC team considered cost-estimation methods used in other studies as well, including the relationship of construction cost versus water quality volume, which was used in the Caltrans BMP Retrofit Pilot Program (Caltrans 2004), and the relationship of construction cost versus total drainage area, which was typically used in the Water Environment Research Foundation (WERF) models (Lambe et al. 2005) and is discussed below, along with WERF’s 2012 update.

NCDOT found the most appropriate relationship to be that of construction cost versus water quality volume because BMPs, particularly NCDOT’s Level I treatment, is typically sized based on the water quality volume, so that relationship was simplified to be that of construction cost versus impervious drainage area (see Figures A-2 and A-3). While retrofit

<sup>191</sup> NCDOT/URS, p. 7-10

<sup>192</sup> NCDOT/URS, p. 7-7

<sup>193</sup> NCDOT/URS, p. 7-8

<sup>194</sup> NCDOT/URS, p. 7-14

**Table A-4. Arizona DOT annual maintenance BMP costs.**

BMP	Upfront Construction Costs <sup>1</sup>	Annual Maintenance Costs <sup>1</sup>
<b>Offroad, Overland Flow Erosion Control</b>		
Retaining wall	N/A <sup>2</sup>	N/A
Slope Modification and New Slope Construction	Terraces \$1.20 - \$14.50 / lineal foot	N/A
Impervious Cover	N/A	N/A
Seed Mix	\$0.05 - \$0.25 / yd <sup>2</sup>	15% - 25% of installation
Riprap	\$100 / check dam	N/A
Erosion Control Blanket	Biodegradable \$0.50 - \$0.57 / yd <sup>2</sup>	N/A
Decomposed Granite Cover	\$25/ton	N/A
Wire-tied Rock	N/A	N/A
<b>Roadway Drainage Conveyance</b>		
Culvert Structures	N/A	N/A
Spillways	N/A	N/A
Downdrain Conduits	Slope drain \$5 / lineal foot for flexible PVC pipe	N/A
Inlet Protection	\$65 - \$131 / inlet	N/A
Impervious Channel Lining	Concrete \$60 - \$100 / yd <sup>3</sup>	N/A
Pervious Channel Lining	N/A	N/A
Outlet Protection	N/A	N/A
Bridge Drainage Systems	N/A	N/A
Rainwater Harvesting Practices	N/A	N/A
<b>Water Quality and Treatment</b>		
Vegetated Filter Strip	Established from: <ul style="list-style-type: none"> <li>• Using existing vegetation - \$0</li> <li>• Seeding - \$530/acre-VFS</li> <li>• Sodding - \$14,190/acre-VFS</li> </ul>	N/A
Infiltration Basin	\$0.55/ft <sup>3</sup> of storage	\$0.04/ft <sup>3</sup> of storage
Infiltration Trench	\$4.36/ft <sup>3</sup> of storage	\$0.04/ft <sup>3</sup> of storage
Bioretention	\$6.83/ft <sup>3</sup> of storage	N/A
Filtration Structures	\$2.63/ft <sup>3</sup> of storage	N/A
Manufactured Treatment Devices	\$2,200 each	\$164 each
Retention and Detention Basins	\$0.55/ft <sup>3</sup> of storage	\$0.009 – \$0.08/ft <sup>3</sup> of storage (retention)
		\$0.008 – \$0.33/ft <sup>3</sup> of storage (detention)

**Notes:**

<sup>1</sup> Unit costs are very approximate and should only be used for comparison and informational purposes. Do not use these costs for construction cost estimates.

<sup>2</sup> N/A – Unit cost data is either not available or is not an appropriate measurement of costs for the BMP.

construction costs were found to be only 17% higher than comparable new construction, without incorporating higher unit costs for materials on smaller projects, retrofit design costs were found to be two and a half times those of non-retrofit SCM design costs.

Enhanced maintenance and inspection costs have not been calculated, but are anticipated to be related to additional training of inspectors and additional effort during the inspection process for recognition and documentation of potential conveyance and collection issues, should such a program move forward.<sup>195</sup>

Arizona DOT estimated available construction costs for various BMPs and is just beginning to note and compile annual maintenance costs, as shown in Table A-4.<sup>196</sup>

WSDOT’s extension of AVL-GPS to the remainder of their fleet and integration with the state’s labor/maintenance management tracking system will enable the state to collect actual costs to maintain BMPs, starting in 2013.

In the DOT interviews for this project, NCDOT noted that problems with the use of traditional BMPs for bridge deck runoff mitigation extend beyond capital cost and space constraints. The existing mitigation approach is administrative, capital, and maintenance intensive. For example, piping

<sup>195</sup> Project interview with Matt Lauffer, Hydraulics Unit, North Carolina Department of Transportation, Jan. 28, 2013

<sup>196</sup> Arizona DOT Stormwater Manual, p. 162, Table B.6



**Table A-5. Summary of construction and maintenance costs from BMPDB.**

BMP Type	No. of Studies with Construction Costs	No. of Studies with Maintenance Cost	Average Construction Cost (Range)	Average Maintenance Cost/yr (Range)
Vegetated Swale	6	0	\$101,250 (\$60,000 - \$140,000)	N/A
Dry Detention Basin	5	0	\$299,566 (77,389 - \$819,852)	N/A
Vegetated Strip	3	0	\$213,333 (\$110,000 - \$300,000)	N/A
Manufactured Device	17	8	\$38,290 (\$320 - \$180,000)	\$932/yr (\$80 - \$3,000)
Bioretention	1	1	\$150,000	\$3,000/yr
Media Filter	10	1	\$341,505 (\$100,000 - \$476,106)	\$3,000/yr
Wet Retention Pond	1	0	\$691,496	N/A

runoff to the abutment for treatment requires a structural BMP as well as an outlet structure to the receiving water, which requires environmental permitting and potentially an engineered energy dissipater. The whole-life cost of the traditional approach is high compared to passive methods on an at-grade highway cross section, such as engineered vegetative filter strips.

### **NCHRP Project 25-40 Information on the Whole Life Costs of BMPs**

NCHRP Project 25-40, to be completed in 2014, will provide further BMP performance and cost information, building on the initial literature review results discussed below. While design, site, and cost information is relatively sparse in the International BMP Database (BMPDB), there are some studies where this ancillary information is documented. Only 43 studies out of the 133 (32%) contained any construction cost information, and 10 studies (7.5%) contained maintenance costs. A summary of costs including averages and ranges of construction and maintenance costs, where available, by BMP type is provided in NCHRP Project 25-40; the median effluent concentrations for 10 selected BMP studies are then compared to the categorical median effluent concentrations presented for some selected constituents; and performance trends based on the time series of available influent/effluent data pairs for the individual studies are then evaluated.

The wet retention pond and the media filters contained the highest average construction costs and the manufactured device contained the lowest construction cost. Out of the

three BMP types with maintenance cost information available, the manufactured device contained the lowest average maintenance costs per year. As Table A-5 shows, there was a large range of construction costs for each type of BMP and the sizes of projects and drainage areas differed as well as the number of studies available. Table A-6 summarizes the construction and maintenance costs according to drainage area and impervious drainage area.

WEF (2012) and Lampe et al. (WERF 2005) produce life cycle cost analyses for a variety of BMP types.<sup>197</sup> Some of the concluding highlights are noteworthy:<sup>198</sup>

- Maintenance costs of **wet basins** make up almost 50% of the whole life cost when basins are implemented in high-visibility locations, where aesthetics are at a premium. **Dry basins** tend to be easier and less expensive to maintain because there is little or no standing water in the facility. Wet and dry basins cost the same to construct.
- The primary maintenance cost of **bioretention** is associated with vegetation management. The frequency of this activity was assumed similar to swales, but with a greater cost because many bioretention facilities would require weeding, mulch replacement, and other activities beyond the mowing required for most swales.
- For **swales and filter strips**, water quality benefits can effectively be considered as no cost if these areas are already maintained.

<sup>197</sup> Lampe, Barrett, et al. Water Environment Research Foundation (2005) Performance and Whole Life Costs of Best Management Practices and Sustainable Urban Drainage Systems; Project 01-CTS-21Ta; Water Environment Research Foundation: Alexandria, Virginia. 225 p., 2005

<sup>198</sup> Barrett, WEF, 2012, pp. 502–509

**Table A-6. Average construction cost and maintenance cost per year.**

(According to Drainage Area and Impervious Drainage Area)

BMP Type	Average Construction Cost per Acre of Drainage Area (Range)	Average Construction Cost per Acre of Impervious Drainage Area (Range)	Average Annual Maintenance Cost per Acre of Drainage Area (Range)	Average Annual Maintenance Cost per Acre of Impervious Drainage Area (Range)
Vegetated Swale	\$89,483 (\$5,503 - \$187,890)	\$94,671 (\$5,789 - \$194,849)	N/A	N/A
Dry Detention Basin	\$60,282 (\$27,147 - \$97,870)	\$127,283 (\$39,253 - \$291,038)	N/A	N/A
Vegetated Strip	\$164,828 (\$95,957 - \$222,577)	\$164,828 (\$95,957 - \$222,577)	N/A	N/A
Manufactured Device	\$50,926 (\$980 - \$428,491)	\$51,251 (\$980 - \$428,491)	\$1,824 (\$138 - \$7,142)	\$1,825 (\$153 - \$7,142)
Bioretention	\$75,879	\$94,848	\$1,518	\$1,897
Media Filter	\$252,121 (\$80,681 - \$569,090)	\$279,754 (\$144,714 - \$674,477)	\$4,669	\$4,669
Wet Retention Pond	\$164,611	\$341,267	N/A	N/A

- Infiltration trenches** may require little routine maintenance outside of litter and debris removal. The whole life cost driver is the frequency with which the trench must be rehabilitated. Intervals of 4, 8, and 12 years were assumed based on low, medium, and high scenarios, at which time the cost is essentially the same as the original construction cost. For **infiltration basins**, the capital cost and routine maintenance are essentially the same as those for a dry basin, but an infiltration basin can incur much higher costs associated with maintaining sufficient infiltration rates. In addition to sediment removal, an infiltration basin may require additional activities to remove and replace clogged soils on the floor of the basin. The frequency of this activity is largely dependent on the initial soil texture and the rate at which sediment accumulates in the basin.
- With **pervious pavement** in the same location as a conventional surface, the cost for the water quality control facility is the incremental cost difference between a conventional pavement and pervious pavement. DOT interest has been fostered regarding permeable thin lift overlays through safety and livability co-benefits offered: better visibility and traction in storm events, reduced splash and hydroplaning, and reductions in deflected noise from highway traffic. Now porous asphalt overlays are being used in Georgia, California, and Utah as well. The use of permeable overlays (PFC) was up to 8.1% of all pavements in Texas in 2010. The overlay is assumed to need replacement

more frequently (every 25 years vs. 35 and 40 years) at a cost equal to original construction. Water quality monitoring of three locations in the Austin area indicates up to a 90% reduction in pollutant discharges from PFC compared to conventional pavement. This reduction is the result of accumulation of pollutants within the pavement and the reduction in pollutants washed off vehicles during storm events.<sup>199</sup>

The NCHRP Project 25-40 interim report points out that with the exception of infiltration trenches, which may clog/fail and require total reconstruction on a shorter timeframe than many other facilities, the higher level maintenance cost scenario is driven by aesthetics and local expectations for frequency of mowing, rather than functioning of the water quality facility. In initial NCHRP Project 25-40 interviews, Maryland SHA Hydraulics staff reported, “infiltration BMPs are failing more quickly and the reasons are not always clear. Removing the top layer of soil, some infiltration facilities can be restored to initial conditions, but some do not. Facilities may prematurely fail due to generally poor soil characteristics, rising groundwater or groundwater mounding.”<sup>200</sup>

<sup>199</sup>Bradley J. Eck, Ph.D., P. E., J. Brandon Klenzendorf, Ph.D., Randall J. Charbeneau, Ph.D., P. E., Michael E. Barrett, Ph.D., P. E. Investigation of Stormwater Quality Improvements Utilizing Permeable Friction Course (PFC), September 2010

<sup>200</sup>Project interview, Karuna Pujara, MDSHA, December 20, 2012

**Table A-7. Whole life costs of common BMPs per cubic meter of stormwater treated.**

(WEF, 2012)

Stormwater Control	Whole Life Cost (\$/m <sup>3</sup> )		
	Low Maintenance	Medium Maintenance	High Maintenance
Swales/Strip	500	660	2200
Wet Ponds/Wetlands	520	600	925
Dry Extended Detention Basins	330	375	575
Sand Filter	450	520	670
Bioretention	1900	2200	5100
Infiltration Trench	1200	1600	2700
Infiltration Basin	330	400	700
Permeable Pavement	570	640	1400

DOTs can preserve functioning and extend the life cycle of BMPs if they prevent sedimentation of permanent BMPs during construction on the project or upstream, as “the majority of sediment problems” in permanent controls are caused by inadequate erosion and sedimentation control from construction upstream of the structure. In a stable urban watershed, WEF estimates that normal annual accumulation of sediment would be less than 1 cm per year.<sup>201</sup> A UK survey identified that no upstream pretreatment was provided in 85% of the stormwater controls where sediment was a problem, a particular issue in the more expensive maintenance involved in wet basins.<sup>202</sup> Heavier solids, leaves, trash, and debris frequently outweigh the load based on total suspended solids.<sup>203</sup>

To facilitate comparison of costs among BMP types, Barrett et al. normalized the whole life cost for each system for high, medium, and low maintenance scenarios for each BMP type, based on the equivalent water quality volume. The team identified a number of important caveats and lessons. First, water quality benefits from some controls, such as swales and strips, can effectively be considered free when compared to conventional drainage systems, and when the maintenance is performed by the property owner. Further, “a bare-bone, marginal maintenance program (e.g., inspections every 3 years and little vegetation management) does not save that much money compared to a maintenance program at the medium level.”<sup>204</sup> Higher-level maintenance costs were often driven by aesthetics more than performance requirements.

<sup>201</sup> Barrett, WEF, 2012, p. 433

<sup>202</sup> WEF, 2005, cited in Barrett/WEF 2012, p. 434

<sup>203</sup> California Department of Transportation (2004) BMP Retrofit Pilot Program, Final Report; CTSW-RT-01-050; California Department of Transportation: Sacramento, California

<sup>204</sup> Michael Barrett et al., Design of Urban Stormwater Controls Manual of Practice (MOP 23), Water Environment Foundation, June 2012. <https://www.e-wef.org/Home/ProductDetails/tabid/192/Default.aspx?ProductId=18172>.

In line with these conclusions, in initial Project 25-40 interviews, at least one DOT noted that BMPs located in proximity to frequent callers and/or influential people received a higher level of maintenance. Table A-7 shows whole life costs of common BMPs per cubic meter of stormwater treated.

Media filters had the highest average construction cost based upon drainage area; however, the wet retention pond (only 1 study) had the highest average construction cost based upon impervious drainage area. The manufactured devices had the lowest average construction cost based upon drainage area and impervious drainage area. In general, manufactured devices (which include a wide variety of practices including hydrodynamic devices and cartridge filters) tended to be a cheaper type of BMP to treat highway/roadway, park and ride, or maintenance station stormwater runoff. However, these BMPs also tend to be among the worst performers with respect to pollutant removal. According to the limited maintenance cost information available, bioretention (only 1 study) has the cheapest average maintenance cost per acre of drainage area and media filters (only 1 study) have the highest cost. Manufactured devices (8 studies) have cheaper average maintenance cost per acre of impervious drainage area. Clearly, cost information is extremely limited, so care should be taken when generalizing about BMP construction and maintenance costs.

It is important to note that unit construction cost estimates are far from the whole story of DOT costs. With whole life costs, as summarized with Lampe et al. in 2004 and Barrett/WEF in 2012, maintenance costs are included in the present value analysis. This significantly increases the unit costs for maintenance intensive controls. Further, the manufactured devices from the International BMP Database include a wide range of devices including catch basin inserts, cartridge filters, oil/water separators, hydrodynamic devices, MCTTs, etc.; this results in a huge range of unit costs (\$980–\$430,000). More detailed cost analysis of the individual manufactured devices

is necessary to get an improved range for the various device types, but even then the data are limited (only 17 studies with construction cost information; only eight with maintenance cost information).

## **NCHRP Report 474 on Cost-Benefit Strategies for Bridge Deck Runoff**

*NCHRP Report 474* has relatively little on cost-benefit evaluation strategies for bridge deck runoff. Volume 2 notes that annual maintenance costs for structural BMPs are important cost considerations; “BMPs that are not maintained can quickly lose any pollutant removal capabilities. Furthermore, a BMP that is not maintained could pose a hazard to the highway or bridge where lack of maintenance has reduced the BMP’s capacity to handle the volume of runoff planned.”<sup>205</sup> They recommend “methods that directly consider operation and maintenance costs over the life of the bridge . . . to ensure that this often critical cost is not overlooked in the analysis.”<sup>206</sup> As the NCHRP Project 25-13 research team states, the various methods they describe in their report are general and well known; “consequently, bridge engineers and designers are generally already knowledgeable about these methods.”<sup>207</sup>

**Present value analysis** (a component of most of the methods discussed later) provides a framework for comparing the direct costs and benefits of project alternatives by accounting for the “time value” of money and opportunity costs (the cost of giving up the opportunity to use or invest the resource). Because net present value combines the effects of costs and benefits, it would not be as useful as benefit/cost analysis in estimating the relative efficiency of various projects.

**Benefit/cost analysis** focuses on the efficiency of project alternatives. It is a basis for comparing and ranking projects with different goals or varying scales. Benefit/cost analysis also includes an estimate of the relationship of all benefits and costs to society by translating indirect costs and benefits into dollars (the sum of all direct and indirect costs borne by or accrued to everyone). If all costs and benefits were direct, net present value and benefit/cost analyses would yield identical results. Using dollars as a common denominator allows conflicting objectives to be compared. Because benefits and costs often accrue in different patterns over time, it is usually necessary to discount them to a present value. The cost parameters associated with the alternatives can be defined to include both initial investment costs and the present value of maintenance costs anticipated over the life of the facilities.

**Cost-effectiveness analysis** is primarily useful when comparing the costs (and determining the least-cost approach)

of different ways of achieving the same measurable goal. This method rests on the assumption that any additional benefits beyond meeting the goal and any nonmonetary costs are insignificant. If those benefits or costs are significant, a technique that focuses on efficiency, such as benefit-cost analysis, would be preferred. Cost-effectiveness analysis would, therefore, be most useful in evaluating situations in which a single goal exists rather than multiple goals. One important consideration for all projects is the economic quantification of environmental value. Many stakeholders view economic quantification of environmental resources as controversial. For stormwater BMPs, the common cost-effectiveness metric is the BMP cost per unit mass of pollutant removed (Brown and Schueler 1997).

**Life Cycle Cost Analysis** takes into consideration the total cost of constructing and implementing a facility for its useful life. Historical cost curves, useful life, replacement costs, and operating cost histories for similar facilities are used to aid decision making. In some cases, this type of analysis might identify bridges that should be retrofitted to help establish prioritization of limited funds. Understanding the life cycle stage of retrofit projects competing for highway agency dollars makes it possible to consider such factors as these in the resource allocation process:

- Projected changes in annual maintenance costs throughout the remainder of the useful life of the equipment or structure.
- Opportunities to extend the useful life of the facility through early restoration or rehabilitation.
- Risk of significant increases in the cost of implementing the mitigation measures if they are delayed 1 year, 5 years, or some other interval of time.

Analysis of life cycle cost can be combined with benefit/cost analysis or other related methods in developing components for evaluating mitigation strategies.

**Production theory optimization**, a stormwater BMP economic optimization method based on production theory and marginal benefits and costs, has been used for a number of combined sewer overflow and stormwater control projects. Production theory optimization analysis is a quantitative method of comparing candidate BMPs to arrive at an optimal solution. It relies on information developed in the technologies evaluation steps, including performance (i.e., pollutant removal effectiveness), cost, and interactions of individual BMPs. It is most useful in cases in which multiple BMPs are considered. CH2M Hill has developed a computerized program (BEST) that simplifies what otherwise would be a laborious evaluation process. This approach may be applicable to larger bridge projects in which the potential costs and benefits warrant this degree of sophistication.

<sup>205</sup> NCHRP Report 474, Vol. 2, p. 71-73

<sup>206</sup> NCHRP Report 474, Vol. 2, p. 71-73

<sup>207</sup> NCHRP Report 474, Vol. 2, p. 71-73



**BMP ranking procedure.** The objective of using a BMP is often to protect aquatic life or prevent spills from entering a receiving water. When faced with limited resources to protect receiving waters, it may be worthwhile to evaluate BMPs with regard to pollutant removal efficiency and cost. A series of steps and formulas were developed by Caltrans (Pilgrim 2001), similar to CH2M Hill's production theory optimization concept, to rank a list of proposed BMPs by evaluating the ratio of cost to effectiveness for each BMP. The Caltrans method is different than production theory optimization in that a numerical evaluation of BMP removal efficiency is weighted by giving greater value to the removal of pollutants that are of particular concern. Once the optimal BMP is identified, it can be compared with mitigating stormwater with similarly evaluated BMPs at other sites in the watershed (e.g., mitigation banking, pollutant trading). Hence, this procedure can also be used to identify when treatment of bridge runoff is not practical—that is, if significantly greater benefits could be realized by treating runoff, for the same or lower costs, from impervious areas that discharge into other locations within the same body of water or watershed. BMPs are ranked by calculating a selection value according to the following formula

$$SV = \frac{(C + M + E)}{AF}$$

where

SV = selection value (lowest value = best BMP option)

C = BMP cost

M = present worth of maintenance cost (10 years used by Caltrans)

E = present worth of environmental monitoring costs (10 years used by Caltrans)

A = area of watershed treated by BMP

F = pollutant removal factor

The pollutant removal factor is a composite value for several stormwater runoff constituents and spills and is based on the following equation:

$$F = f_1p + f_2p + f_3p + \dots + f_i + f_{\text{spills}}$$

where

$f_i$  = weighting factor for each pollutant of interest

$f_{\text{spills}}$  = weighting factor for spills

p = pollutant removal efficiency (% removal/100)

There are a number of potential approaches to developing weighting factors. Professional judgment could be used to assign “f” values for each pollutant of interest. For example, if sediment is considered the most problematic pollutant, a large “f” value (e.g., 100) would be assigned to sediment. If aquatic toxicity was the primary concern, large “f” values could be

assigned to metals such as copper and zinc (e.g., 100), whereas lower values (e.g., 40) would be assigned to sediment. Clearly, street sweeping would not be a viable option for spill containment, and in this case, the pollutant removal factor (p) would be zero. A more quantitative method would be to use monitoring data and water quality criteria to identify the problematic pollutants. In this case, the “f” factor could be calculated as the frequency, in percent, with which a particular runoff pollutant exceeds water quality criteria. This would link the “f” factor to the protection of the designated use of the receiving water body. The “f” factor for spills may be based on professional judgment and might include consideration for the risk of spills, downstream drinking water sources, and the nature of the receiving water (i.e., how quickly it flushes).

## Availability of Bridge Deck Runoff Data

To assist in these efforts, the research team asked interviewed DOTs whether they had bridge runoff datasets that could be shared. Nearly all states said they did not. One said they had no way to collect such information. Another had some data but the DOT had to make it unavailable when they found there were some problems in the data. The DOT is doing QA/QC and this data could be available later.

NCDOT indicated that all of the data collected for their report are available in the USGS report and on the USGS website.<sup>208</sup> The station numbers are in the report and the USGS data can be queried for that. The USGS report contains data on bridge runoff, quality, quantity and stream quality—more comprehensive than NCDOT's data. The USGS report includes appendices with the data summarized in different ways, including Excel spreadsheets. The appendices contain water-quality concentrations and loads, bed-sediment concentrations and bridge deck runoff and in-stream discharge data. NCDOT has biosurvey and bioassay reports, bridge sweeping sediment quality data, traffic counts, and additional bioassays and biosurveys beyond what is in the report, none of which changed the report's conclusions in the report. USGS noted that researchers can also download the data directly from the USGS National Water Information System web site at the following links:<sup>209</sup>

- Water- and bed sediment-quality data (<http://nwis.waterdata.usgs.gov/nc/nwis/qwdata>)
- Discharge and rainfall data (<http://nwis.waterdata.usgs.gov/nc/nwis/sw>)

<sup>208</sup> USGS report entitled “Characterization of Stormwater Runoff from Bridges in North Carolina and the Effects of Bridge Deck Runoff on Receiving Streams” <http://pubs.usgs.gov/sir/2011/5180/>

<sup>209</sup> Project interview with USGS, Chad Wagner, Hydrologic Modeling and Investigations Section, U.S. Geological Survey, Raleigh, NC, December 20, 2012

<sup>209</sup> NCHRP 25-40 Interim Report (Literature Review Results), June 2012

<sup>209</sup> Strecker, E. W., Mayo, L., Quigley, M. M., and J. Howell (2000) Guidance Manual for Monitoring Highway Runoff Water Quality. Federal Highway Administration, Unpublished Draft, Contract DTFH651-94-C-00108 FHWA (August 2001). Urban Drainage Design Manual, Hydraulic Engineering Circular No. 22, Second Edition, prepared by S. A. Brown, S. M. Stein, and J. C. Warner. Federal Highway Administration, Washington, D.C.

<sup>209</sup> Strecker, E. W., W. C. Huber, J. P. Heaney, D. Bodine, J. J. Sansalone, M. M. Quigley, D. Pankani, M. Leisenring, and P. Thayumanavan (2005). Critical Assessment of Stormwater Treatment and Control Selection Issues, Water Environment Research Foundation (WERF); Report No. 02-SW-1. ISBN 1-84339-741-2. 290p

<sup>209</sup> Venner, M., Compendium of Environmental Stewardship Practices in Construction and Maintenance, AASHTO, 2004. NCHRP 25-25/04, maintained online at AASHTO's Center for Environmental Excellence

<sup>209</sup> Urban Drainage and Flood Control District, Urban Storm Drainage Criteria Manual Volume 3, August 2011 <http://www.udfcd.org/downloads/pdf/critmanual/Volume%203%20PDFs/USDCM%20Volume%203.pdf>, p. 2-13.

<sup>209</sup> OSU et al., Evaluation of Best Management Practices for Highway Runoff Control, NCHRP Report 565, 2006

<sup>209</sup> McNett et al., 2010 cited in NCDOT/URS, 2010

<sup>209</sup> NCDENR, 2009; NRC, 2008. cited in NCDOT/URS, 2010

<sup>209</sup> NCDOT/URS p. 8-2

<sup>209</sup> Project interview with Matt Lauffer and Kathy Herring, NCDOT, and Michelle Mayfield, Alex Nice (URS Corp), and Chad Wagner, USGS, December 20, 2012

<sup>209</sup> NCDOT/URS, 2010, p. 6-2

<sup>209</sup> NCDOT/URS. Stormwater Runoff from Bridges, Final Report, July 2010, p. 6-2

<sup>209</sup> NCDOT/URS, 6-22 and 6-23

<sup>209</sup> NCDOT, 2-10-2-11

<sup>209</sup> NCDOT/URS, p. 6-21

<sup>209</sup> Project interview with Doug Blades, P. E., Structural Engineer, FHWA, Office of Bridge Technology Washington, DC, January 29, 2013

<sup>209</sup> Alaska DOT & PF's Bridge Deck Runoff study, p. 54

<sup>209</sup> Perkins, R., and Hazirbaba, Y., Alaska UTC and DOT & Public Facilities, Bridge Deck Runoff: Water Quality Analysis and BMP Effectiveness, December 2010, pp. 1-6, 59-60, 62-64

<sup>209</sup> Eck, Bradley, et al. Water Quality of Drainage from Permeable Friction Course, Journal of Environmental Engineering, ASCE, February 2012, pp. 174

<sup>209</sup> Project Interview with Mark A. Giffin, Project Manager, SC Department of Health and Environmental Conservation, Division of Water Quality, January 7, 2013

<sup>209</sup> NCDOT/URS, Stormwater Runoff from Bridges, Final Report to Joint Legislation Transportation Oversight Committee, North Carolina Department of Transportation, 2010

<sup>209</sup> NCDOT/URS, p. 8-4

<sup>209</sup> NRC, 2008, cited in URS/DOT, p. 7-2

<sup>209</sup> NRC, 2008; Lambe et al., 2005; Wossink and Hunt, 2003. Cited in URS/DOT, p. 7-1

<sup>209</sup> NCDOT/URS, p. 7-14

<sup>209</sup> Project interview with Matt Lauffer, Hydraulics Unit, North Carolina Department of Transportation, Jan. 28, 2013

<sup>209</sup> Arizona DOT Stormwater Manual, p. 162, Table B.6

<sup>209</sup> Lampe, Barrett, et al. Water Environment Research Foundation (2005) Performance and Whole Life Costs of Best Management Practices and Sustainable Urban Drainage Systems; Project 01-CTS-21Ta; Water Environment Research Foundation: Alexandria, Virginia. 225 p., 2005

<sup>209</sup> Barrett, WEF, 2012, pp. 502-509

<sup>209</sup> Bradley J. Eck, Ph.D., P. E., J. Brandon Klenzendorf, Ph.D., Randall J. Charbeneau, Ph.D., P. E., Michael E. Barrett, Ph.D., P. E. Investigation of Stormwater Quality Improvements Utilizing Permeable Friction Course (PFC), September 2010

<sup>209</sup> Project interview, Karuna Pujara, MDSHA, December 20, 2012

<sup>209</sup> Barrett, WEF, 2012, p. 433

<sup>209</sup> WERF, 2005, cited in Barrett/WEF 2012, p. 434

<sup>209</sup> California Department of Transportation (2004) BMP Retrofit Pilot Program, Final Report; CTSW-RT-01-050; California Department of Transportation: Sacramento, California

<sup>209</sup> Michael Barrett et al., Design of Urban Stormwater Controls Manual of Practice (MOP 23), Water Environment Foundation, June 2012. <https://www.e-wef.org/Home/ProductDetails/tabid/192/Default.aspx?ProductId=18172>

<sup>209</sup> NCHRP Report 474, Vol. 2, p. 71-73

## ATTACHMENT A - 1

# Sample Off-Site Compensatory Treatment Guidelines

## North-West Florida Water Management District Compensatory Treatment Guidelines

### Compensating Stormwater Treatment

Occasionally, applicants find that it is impractical to construct a stormwater management system to capture the runoff from a portion of the project site due to on-site conditions such as extreme physical limitations, availability of right-of-way, or maintenance access. Two methods have been developed to compensate for the lack of treatment for a portion of a project. The first method is to treat the runoff that is captured to a greater extent than required by rule (i.e., “overtreatment”). The second method is to provide treatment for an off-site area which currently is not being treated (i.e., “off-site compensation”).

Either of these methods will only be allowed as a last resort and the applicant is strongly encouraged to schedule a pre-application conference with agency staff to discuss the project if these alternatives are being considered. Other rule criteria, such as peak discharge attenuation, will still have to be met if the applicant utilizes these methods. Each alternative is described in more detail in the following sections.

#### *Overtreatment*

Overtreatment means to treat the runoff from the project area that flows to a treatment system to a higher level than the rule requires to make up for the lack of treatment for a portion of the project area. The average treatment efficiency of the areas treated and the areas not treated must meet the pollutant removal goals of Chapter 62-40, F.A.C., (i.e., 80% removal for discharges to Class III waters and 95% removal for systems that discharge to OFWs.) To meet these goals, the area not being treated generally must be small (less than

10%) in relation to the area that is captured and treated. Staff can aid in determining the proper level of overtreatment for a particular situation.

#### *Off-site Compensation*

Off-site compensation means to provide treatment to compensate for the lack of treatment for portions of the proposed project. The following conditions must be met when utilizing off-site compensation:

- (a) The off-site area must be in the same watershed as the proposed project, and in the closest vicinity practical to the location of those untreated stormwater discharge(s) requiring compensating treatment; and
- (b) The applicant shall use modeling or other data analysis techniques that provide reasonable assurance that the compensating treatment system removes at least the same amount of stormwater pollution loading as was estimated from the untreated project area.

### Flexibility for State Transportation Projects and Facilities

Due to the unique limitations of state linear transportation projects and facilities, subsection 373.413(6), F.S. (2012) requires the agency, during the review of such activities, to consider and balance the expenditure of public funds for stormwater treatment with the benefits to the public in providing the most cost-efficient and effective method of achieving the treatment objectives of stormwater management systems. To do so, alternatives to onsite treatment for water quality will be considered, which may include regional stormwater treatment systems.

# ATTACHMENT A-2

## DOT BMP Selection Matrices

Table A-8. MassDOT BMP selection matrix.

BMP Type	Best Management Practice	Handbook Reference	Pre-treatment Required?	Peak Discharge Rate Control			Recharge <sup>6</sup>	TSS Removal		Higher Pollutant Loading	Discharges to or near Critical Areas	Re-development	Pollutant Removal Efficiencies - MassDOT Stormwater Handbook <sup>11</sup>				Other Pollutants of Concern		
				2-yr Storm	10-yr Storm	100-yr Storm		Applicability	MassDOT Removal Credit <sup>12</sup>				Total Nitrogen	Total Phosphorus	Metals (Cu, Pb, Zn, Cd)	Pathogens	pH	Thermal modification/ Temperature	Chloride
<b>Source Control and Non-Structural BMPs</b>																			
4	Street Sweeping	DEP	n/a	n/a	n/a	n/a	*	0% - 10% Varies w/frequency											
5	Semi-annual Catch Basin Cleaning <sup>13</sup>						*												
6	No Application of Fertilizers Containing Phosphorus <sup>13</sup>						*												
7	No sand zone for seeding						*												
8	Designate as Low Jet Zone						*												
9	Install Discharge Review						*												
10	Review of bird habitat impacts						*												
<b>Structural Pretreatment BMPs</b>																			
13	Deep Pump Catch Basin	MassDOT (DEP)	no				*	25%		*	*	*							
14	Oil/Grease Separator	MassDOT (DEP)	no				*	25%		*	*	*							
15	Proprietary Separator	DEP	Varies				*	Varies											
16	Sediment Forebay	MassDOT (DEP)	no				*	25%		*	*	*							
17	Vegetated Filter Strip	MassDOT (DEP)	no				*	10% - 45% (width 25' - 50')		*	*	*							
18	Open Gravel Friction Course	MassDOT	no				*	44% <sup>10</sup>		*	*	*							
<b>Treatment BMPs</b>																			
20	Bioretention Area/Rain Garden	MassDOT (DEP)	yes				*	80% with vegetated filter strip or equivalent		*	*	*							
21	Stormwater treatment basins						*			*	*	*							
22	Extended Dry Detention Basin	MassDOT (DEP)	yes	*	*	*	*	20% w/ sediment forebay		*	*	*							
23	Wet Basin	MassDOT (DEP)	yes	*	*	*	*	80% w/ sediment forebay		*	*	*							
<b>Constructed Wetlands</b>																			
24	Constructed Stormwater Wetland	MassDOT (DEP)	yes	*	*	*	*	80% w/ sediment forebay		*	*	*							
25	Gravel Wetland	MassDOT (DEP)	yes	*	*	*	*	80% w/ sediment forebay		*	*	*							
<b>Filtration BMPs</b>																			
27	Sand or Organic Filter	MassDOT (DEP)	yes				*	80% w/ sediment forebay		*	*	*							
28	Proprietary Media Filter		Varies				*	Varies		*	*	*							
29	Media Filter Drain	MassDOT	no				*	80% <sup>11</sup>		*	*	*							
30	Compost Amended Vegetated Filter Strip	MassDOT	no				*	80% <sup>11</sup>		*	*	*							
<b>Conveyance BMPs</b>																			
31	Drainage Channel	MassDOT (DEP)	yes				*	0%		*	*	*							
32	Grassed Channel (Biofilter Swale)	MassDOT (DEP)	yes				*	50% w/ pretreatment		*	*	*							
33	Water Quality Swale						*			*	*	*							
34	Dry Swale	MassDOT (DEP)	yes				*	70% w/ pretreatment		*	*	*							
35	Wet Swale	MassDOT (DEP)	yes				*	70% w/ pretreatment		*	*	*							
<b>Infiltration BMPs</b>																			
38	Dry Well	MassDOT (DEP)	no				*	80%		*	*	*							
39	Infiltration Basin	MassDOT (DEP)	yes				*	80% w/ pretreatment		*	*	*							
40	Infiltration Trench	MassDOT (DEP)	yes				*	80% w/ pretreatment		*	*	*							
41	Leaching Catch Basin/Leaching Basin	MassDOT (DEP)	yes				*	80% if offline w/ pretreatment		*	*	*							
42	Subsurface Structure	MassDOT (DEP)	yes				*	80%		*	*	*							
<b>Other BMPs</b>																			
43	Dry Detention Basin	MassDOT (DEP)	no	*	*	*	*	0%		*	*	*							
44	Green Roof <sup>1</sup>	DEP	no				*	n/a		*	*	*							
45	Permeable Pavement	MassDOT (DEP)	no				*	80%		*	*	*							
46	Rain Barre/Cistern <sup>1</sup>	DEP	no				*	n/a		*	*	*							
47	Outlet/Sediment Trap	MassDOT	no				*	25% <sup>11</sup>		*	*	*							
<b>Accessories</b>																			
48	Level Spreader	DEP	n/a																
49	Check Dam	MassDOT (DEP)	n/a																
50	Outlet Structure	DEP	n/a	*	*	*													
51	Catch Basin Inlet	DEP	n/a																
52	Flow Splitter	MassDOT	n/a																
53	Impoundment Structures: Suggested Design Considerations For Small Dams	MassDOT	n/a																



Table A-9. Georgia DOT, general application BMPs.

STRUCTURAL CONTROL CATEGORY	STRUCTURAL CONTROL	STORMWATER TREATMENT SUITABILITY				WATER QUALITY PERFORMANCE*				SITE APPLICABILITY				IMPLEMENTATION CONSIDERATIONS					
		Water Quality	Channel Protection	Overbank Flood Protection	Extreme Flood Protection	TSS / Sediment Removal Rate	Nutrient Removal Rate (TP/TN)	Bacteria Removal Rate	Hotspot Application	Drainage Area (acres)	Space Req'd (% of tributary imp. Area)	Site Slope	Minimum Head Required	Depth to Water Table	Residential Subdivision Use	High Density / Ultra-Urban	Capital Cost	Maintenance Burden	
Stormwater Ponds	Wet Pond	✓	✓	✓	✓	80%	50%/30%	70%	✓	25 min**	2-3%	15% max	6 to 8 ft	2 feet, if hotspot or aquifer	✓		Low	Low	
	Wet ED Pond	✓	✓	✓	✓				✓						✓	Low	Low		
	Micropool ED Pond	✓	✓	✓	✓				✓						✓	10 min**	✓	Low	Moderate
	Multiple Ponds	✓	✓	✓	✓				✓						✓	25 min**	✓	Low	Low
Stormwater Wetlands	Shallow Wetland	✓	✓	✓	✓	80%	40%/30%	70%	✓	25 min	3-5%	8% max	3 to 5 ft	2 feet, if hotspot or aquifer	✓		Moderate	Moderate	
	Shallow ED Wetland	✓	✓	✓	✓				✓						✓	6 to 8 ft	✓	Moderate	Moderate
	Pond/Wetland	✓	✓	✓	✓				✓						✓	2 to 3 ft	✓	Moderate	Moderate
	Pocket Wetland	✓	✓						✓						5 min	2 to 3 ft	below WT	✓	✓
Bioretention	Bioretention Areas	✓	○			80%	60%/50%	Insuff. data	✓	5 max***	5%	6% max	5 ft	2 feet	✓	✓	Moderate	Moderate	
Sand Filters	Surface Sand Filter	✓	○			80%	50%/25%	40%	✓	10 max***	2-3%	6% max	5 ft	2 feet		✓	High	High	
	Perimeter Sand Filter	✓	○						✓	2 max***						2 to 3 ft	✓	High	High
Infiltration	Infiltration Trench	✓	○			80%	60%/60%	90%		5 max	2-3%	6% max	1 ft	4 feet	✓	✓	High	High	
Enhanced Swales	Dry Swale	✓	○			80%	50%/50%	Insuff. data	✓	5 max	10-20%	4% max	3 to 5 ft	2 feet	✓		Moderate	Low	
	Wet Swale	✓	○			80%	25%/40%	Insuff. data	✓	5 max			1 ft	below WT	✓		High	Low	

✓ - Meets suitability criteria

○ - Can be incorporated into the structural control in certain situations

\* Pollutant removal rates are average removal efficiencies for design purposes

\*\* Smaller area acceptable with adequate water balance and anti-clogging device

\*\*\* Drainage area can be larger in some instances

## ATTACHMENT A - 3

# Methodologies for Discerning Appropriate Treatment of Bridge Deck Runoff

**Summarized from *NCHRP Report 474 Vol. 2, Practitioner's Guide*:**

**METHOD 1: CALCULATION OF IN-STREAM POLLUTANT CONCENTRATION AT THE ZONE OF INITIAL DILUTION.** This method provides a conservative approach to calculating in-stream concentrations of pollutants within a limited region in which stormwater and receiving water mix. The mixed concentration is calculated at the edge of this mixing region, generally called the zone of initial dilution (ZID). State water quality standards usually provide methodologies for the determination of ZID size. Some states do not allow ZIDs and instead compare acute criteria to end-of-pipe concentrations, which in this case would be direct stormwater from the bridge. Acute criteria protect against short-term, lethal effects. Chronic criteria protect against longer-term effects such as growth and reproduction impairment. Another option for states that do not use a ZID concept for acute criteria is to assume complete mixing with a design stream flow specific to acute criteria. In these cases, the complete-mix approach (see Method 2) should be used. If the estimated undiluted runoff concentration for a given parameter is less than the applicable in-stream criterion, there is no reason to undertake mass balance calculations. If the background concentration exceeds the criterion, the practitioner should proceed to methods for cases in which sources of pollutants other than the bridge need to be considered (e.g., Methods 11 and 15).

**METHOD 2: FULLY MIXED IN-STREAM POLLUTANT CONCENTRATION.** Method 2 is applicable to analysis of any situation in which it is assumed that the discharge is fully mixed with the receiving water or some specified fraction thereof. This situation could include acute and chronic aquatic life (e.g., acute effects are short-term lethality, and chronic effects are impairment of growth and reproduction), wildlife, and human health toxicity criteria. Method 2 also is applicable to other water quality standards (i.e., substances such as

salts and color). Calculations of fully mixed in-stream pollutant concentrations have been traditionally used to determine whether pollutants from a continuous point source, such as a municipal or industrial discharge exceed chronic or human health water quality criteria. Because stormwater discharges are intermittent, aquatic organisms as well as humans will experience intermittent exposure to pollutants. Hence, calculation of in-stream pollutant concentrations from average or peak stormwater flows will overestimate (and thus provide a conservative estimate of) the potential for runoff to have a toxic/human health effect. Although this method generally is very conservative, it will nonetheless often demonstrate minimal likelihood of toxicity from specific chemicals in runoff from a bridge deck. If this method predicts an exceedance of one or more criteria, it does not necessarily mean that there will be a real impact in the receiving water. Biological test methods (Methods 4 and 5) can also be used to assess toxicity and may be preferable. Detailed calculation methodologies for each receiving water type (streams and rivers, coastal areas, lakes, wetlands, and reservoirs) are provided along with considerations for chloride discharge and multiple bridges.

**METHOD 3: SEDIMENT POLLUTANT ACCUMULATION MODEL.** One ultimate sink for pollutants is sediment. Once incorporated in sediments, pollutants can either bioaccumulate or cause toxicity to organisms that live in or near the sediment layer. Therefore, comparing sediment criteria to sediment pollutant concentrations near the bridge can identify potential long-term impacts of the bridge. This method describes relatively simple models for the calculation of sediment pollutant concentrations downstream from, or near, bridge deck stormwater discharges. A loading estimate is required for each of the models described in this method. The models assume that the loading is continuous; therefore, appropriate adjustments are necessary to account for the intermittent nature of bridge discharges. As in Method 2, the models apply to streams and rivers, coastal systems, lakes, wetlands, and reservoirs. Until states and EPA

adopt sediment criteria and implementing procedures are published and widely adopted into state water quality regulations, it can reasonably be argued that practitioners should not be expected to evaluate sediment impacts.

**METHOD 4: BIOASSAY METHOD.** This method does not generally apply to new bridge construction unless an existing bridge is used as a surrogate for the new bridge. The potential for adverse effects on receiving waters is often related to storm duration, volume, time between storms (in some cases), traffic volume, and mixing with the receiving water. The area of a receiving water that is potentially affected by toxicity is also a function of mixing. If the runoff is funneled to a single point discharge, the amount of mixing in the receiving water will be less efficient than if the runoff were discharged from multiple points across the bridge deck (analogous to a diffuser). The objective of this test method is to determine if bridge deck runoff has the potential to be acutely or chronically toxic to freshwater or marine organisms under simulated runoff conditions. To meet this objective, a sampling and toxicity testing program has been developed specific to bridge deck runoff that will assess the toxicity of runoff for time-variable exposures. The laboratory bioassay methods described here will provide a scientifically sound and fairly low-cost way to assess the toxicity of bridge runoff to aquatic organisms. Although the methods suggested and organisms to be used are mostly consistent with standard USEPA testing protocols, several deviations are needed to address the time-variable component of storm events. The methods and materials needed for this test are described in detail.

**METHOD 5: BIOSURVEY METHOD.** This method does not generally apply to new bridge construction unless an existing bridge is used as a surrogate for the new bridge. Two integral factors in assessing potential impacts from bridge deck runoff are the intermittent nature of rain events and the initial concentrations of contaminants. As described in Methods 1 through 3, conservative models of pollutant concentrations rely on an assumption of continuous point source input. The biosurvey method, like Method 4, takes into consideration the intermittent nature of rain events and the initial concentrations of contaminants in receiving waters. Method 4 is better suited for assessment of potential impact within an event and for the total event. Method 5 is better for measurement of potential long-term impact. The USEPA and specific state documents should be consulted before conducting a biosurvey program. Methods are generally organism specific, each having advantages and disadvantages. The biosurvey methods presented rely solely on the use of benthic macroinvertebrates as the indicator organisms of choice.

**METHOD 6: RECALCULATION OF HUMAN HEALTH AND WILDLIFE CRITERIA WITH SITE-SPECIFIC DATA.** The USEPA's Great Lakes Water Quality Initiative (GLI), promulgated in March 1995, provides a method by which

bioaccumulation is directly incorporated into ambient water quality criteria for protection of human health and wildlife (USEPA 1995a). USEPA considered the bioaccumulation concepts and methodologies in the GLI to be reflective of the most current science available for criteria development. In general, the numeric criteria developed by USEPA can be used without site-specific modification. In the event that site-specific modification is warranted, the GLI provides guidance on procedures and data requirements for that purpose. Additionally, the GLI describes in detail how human health and wildlife criteria are to be derived for both organic and inorganic substances and provides default values for key parameters, such as food chain multipliers, that are to be used in the absence of substance-specific or site-specific data. The GLI also explicitly identifies 22 substances that are considered to be both persistent and bioaccumulative, referring to them as Bioaccumulating Chemicals of Concern (BCCs). The typical pollutants of highway runoff, including metals such as lead, cadmium, copper, zinc, nickel, and chromium, are not identified BCCs. The USEPA also has developed computer models that can be used by the practitioner for food chain bioaccumulation assessment (see Method 9).

**METHOD 7: FIRST-ORDER DECAY MODELS.** The term "decay" normally refers to the loss, reduction, or attenuation of a non-conservative pollutant in a receiving water by assimilative processes such as bacterial decomposition. The simple first-order decay approach is widely used and described in numerous water quality evaluation texts and relevant USEPA guidance documents. FHWA describes this approach for the highway practitioner. The first-order decay method will often need to be combined with the simple dilution calculations described in Methods 1 and 2. First-order decay processes are included in most of the computerized fate and transport models described in Method 9, but the analyses can also be readily performed with a calculator or spreadsheet. For the case of multiple bridges, the first-order decay model, again usually combined with dilution calculations, can be used to determine if there is a need to consider cumulative impacts (e.g., whether pollutant concentrations reach background levels before the next downstream bridge is reached).

**METHOD 8: SEDIMENT SAMPLING.** This method does not generally apply to new bridge construction unless an existing bridge is used as a surrogate for the new bridge. Two main types of devices are used to collect sediment samples: grab samplers and core samplers. Both devices can be used in toxicity testing and in evaluating chemical and physical properties of the sediment. Core sampling can also be used to evaluate historical sediment records. Location of sites for taking samples will depend on the objectives of the study. However, samples are typically taken from an area of potential contamination and a reference area.

**METHOD 9: FATE AND TRANSPORT MODELS.** If a more rigorous analysis of fate and transport of pollutants is warranted (i.e., for long-term pollutant loading effects and sediment accumulation), a more complex water quality modeling program can be used to assess the effects of short- or long-term loadings on a receiving water. This type of analysis requires significantly more effort than a basic steady-state model or equation approach. However, the results from this type of analysis can be much more accurate and precise in terms of effects on sediment and water column, as well as in terms of potential effects on water intakes. Several USEPA-supported fate and transport models are available from the Center for Exposure Assessment Modeling (CEAM). A description of the most applicable models is provided.

**METHOD 10: LAKE MODELS.** There are many computer-modeling techniques available to predict the effects of stormwater runoff discharges on receiving waters. In the case of lakes, a simplifying complete mix assumption can be used to predict pollutant concentrations. An equation for doing so is provided. That equation and the procedures described for lakes, reservoirs, and wetlands in Methods 1 and 2 focus on conservative substances such as metals and salts. In some cases, bridge runoff effects on eutrophication of these types of water bodies will need to be addressed by practitioners. In these cases, methods outlined by FHWA for highways will be suitable for bridges (Young et al. 1996). However, these water bodies will almost always be subject to nutrient loads from sources other than bridges. Thus, the relative loading analyses, pollutant trading, and stormwater banking options are all viable approaches for nutrients (see Methods 11 and 13).

**METHOD 11: POLLUTANT LOADING.** Two methods of calculating pollutant loads from a bridge deck are described under Method 11. These are a **simple method** and an **intensity-correlation method**. Both require knowledge of pollutant concentrations in runoff. The NCHRP Project 25-13 literature review revealed only a limited number of studies of bridge deck runoff quality; however, the pollutant concentrations reported may be comparable with stormwater quality data for totally impervious highways—that is, studies in which stormwater was monitored directly from pavement. Therefore, impervious highway runoff quality data likely can be used to supplement bridge deck runoff quality data. Although a comprehensive and edited database of bridge and impervious highway runoff quality does not currently exist, multiple sources of highway runoff quality data do exist. These include reports from FHWA, the US Geological Survey (USGS), and state DOTs; academic publications; and state DOT monitoring studies that were performed for compliance with federal and state NPDES stormwater permit requirements.

**METHOD 12: COLLECTION OF SITE-SPECIFIC RUNOFF QUALITY DATA.** If a more precise, site-specific pollutant concentration and loading is desired, field data

can be collected for an existing bridge, or a surrogate bridge with similar attributes as the bridge in question. In 1985, the FHWA published a guidance manual for highway runoff and receiving water monitoring (Dupuis et al., 1985a). In general, the methods described remain valid and applicable today. In addition to their previous studies, the FHWA has recently sponsored development of an updated monitoring guidance document for highway runoff.

**METHOD 14: IN SITU TOXICITY TESTING.** This does not generally apply to new bridge construction unless an existing bridge is used as a surrogate for the new bridge. In situ toxicity studies use a unique method in which organisms that occur as natural populations within the system under study are used as test organisms. In these studies, the endpoint is usually some measure of survival (percentage alive compared with a reference/control group).

**METHOD 15: COMPARISON OF BRIDGE DECK LOADING TO OTHER SOURCE LOADINGS IN WATERSHED.** Comparison of the pollutant loading from a bridge deck with other sources in the watershed can provide an idea of the relative impact from the bridge. Additionally, information needed for pollutant trading, off-site mitigation, and stormwater banking programs can be obtained through such an analysis. Loadings from the bridge deck can be determined by use of Methods 11 and 12, whereas loadings from other sources can be obtained in a variety of ways. The preferred approach is to obtain these estimates from an agency or entity that has already developed them for other reasons (e.g., a local TMDL program).

It will generally be useful to be able to compare the anticipated or predicted pollutant loads from the bridge deck with those from other sources in the watershed. This not only places the impact of the bridge in a relative context, but it also can provide the information needed for pollutant trading, off-site mitigation, and stormwater banking programs. The loading from the bridge can be estimated using Methods 11 and 12. Obtaining estimates of pollutant loadings from other sources in the watershed can be done in a variety of ways.

The preferred approach is to obtain these estimates from an agency or entity that has already developed them for other reasons; however, when these data are inadequate, the responsible agency may consider implementing a water quality monitoring program. With the recent increase in watershed based programs, including TMDLs (see *NCHRP Research Results Digest 235* [Dupuis et al. 1999]), there will be a rapidly expanding database on sources and loads for receiving waters in the United States. Some data will be specific to a particular watershed; other data will be statewide or regional and cover a variety of land uses. These will become increasingly accessible to the practitioner, as evidenced by USEPA's Surf Your Watershed Internet access database (<http://www.epa.gov/surf>). Other sources of applicable water quality information may



include USGS, watershed councils, or university extension offices. Such watershed-specific information will be superior to nonspecific literature values for particular land use types that have often been used in the past (Dupuis et al., 1985b). This is particularly true for agricultural sources, which vary widely because of differences in climate and agricultural practices.

Other methods available to the practitioner range from the very simple (e.g., export coefficients) to sophisticated watershed models (Lahlou et al. 1996; USEPA, 1992a). For most bridge projects, simpler methods should suffice in cases in which loadings data are not already available from other agencies.

If a more in-depth modeling approach is indeed appropriate, a recommended starting point would be USEPA's BASINS modeling framework (<http://www.epa.gov/ostwater/BASINS/>), which is based on a geographic information system (GIS). According to USEPA's BASINS web page (<http://www.epa.gov/ostwater>), BASINS, originally released in 1996, addresses three objectives: (1) to facilitate the examination of environmental information; (2) to provide an integrated watershed and modeling framework; and (3) to support analysis of point and nonpoint source pollution management alternatives. It supports the development of TMDLs, which require a watershed-based approach that integrates both point and nonpoint sources. BASINS can support the analysis of a variety of pollutants at multiple scales, using tools that range from simple to sophisticated.

The heart of BASINS is its suite of interrelated components essential for performing watershed and water quality analysis. These components are grouped into five categories:

1. National databases;
2. Assessment tools (target, assess, and data mining) for evaluating water quality and point source loadings at a variety of scales;
3. Utilities including local data import, land use and dem reclassification, watershed delineation, and management of water quality observation data;
4. Watershed and water quality models including pload, npsm (hspf), swat, toxiroute, and qual2e; and
5. Post processing output tools for interpreting model results. Basins' databases and assessment tools are directly integrated within an ArcView GIS environment. The simulation models run in a Windows environment, using data input files generated in ArcView.

**METHOD 16: ASSESSMENT OF HAZARDOUS MATERIAL SPILLS.** Spills on bridges obviously have the potential to adversely affect aquatic life in the receiving water. Given that most highway spills are of limited volume and duration, the primary concern is acute (i.e., mortality) effects. Oregon has developed documentation of a hazardous

material spill risk assessment (Kuehn and Fletcher 1995) that applies to drinking water supplies. The Oregon document and other studies were used to develop a hazardous material spill risk assessment methodology that consists of three parts. The assessment methodology can be found in the full description of Method 16 provided in the Appendix to this volume and applies to any numeric water quality criterion, whether it be drinking water or acute aquatic life. Another topic relevant to the mitigation of hazardous material spills is "restoration-based compensation," in which the timing of a restoration project in relation to a hazardous material spill is important. For instance, if a restoration project is performed after a spill, the "time value" of the spill must be considered in determining the extent of the project. By the same token, if restoration is prior to the spill, a certain amount of credit becomes available the longer the time is between restoration and the spill event.

**METHOD 17: MICROCOMPUTER SPILL MODELING.**

In rare situations, a bridge project may warrant a more sophisticated assessment of the effects of a spill. In these cases, the practitioner (or consultant) can use a software package such as the Spills Analysis Workstation (SAW) developed by the Danish Hydraulics Institute in Denmark or other specialized programs.

**METHOD 18: RETROFIT PRIORITIZATION METHODOLOGY.** This method does not generally apply to new bridge construction unless an existing bridge is used as a surrogate for the new bridge. Retrofitting bridges with structural stormwater BMPs is technically difficult and can be very costly. Therefore, it is likely that this method would be used on only a limited number of existing bridges. A prioritization method can be used to identify the bridges where bridge deck runoff is substantially affecting the receiving water and where the greatest benefit could be gained by retrofitting. Retrofitting can include the construction of new structural BMPs or modifications to existing BMPs. WSDOT developed a stormwater outfall prioritization system, which uses a rating system to compare the impacts of one outfall to another and makes an assessment of their overall impacts to determine when retrofitting is warranted (WSDOT 1996). WSDOT's outfall prioritization methodology has been modified in Method 18 to address prioritization of bridge deck runoff discharges only.

**METHOD 19: ANTIDegradation ANALYSES.** All states are required by the Clean Water Act to have an antidegradation policy in their water quality standards. The policy is especially intended to protect high-quality waters from new or increased sources of pollution. Additionally, state waters are not allowed to degrade from their existing condition without appropriate analysis, justification, and public input. Although no standardized national protocols exist for antidegradation analyses, many states have specific procedures and methods that must be followed for new or increased discharge of pollutants. The practitioner is thus advised to investigate these restrictions very early in the bridge-planning process.

# ATTACHMENT A - 4

## BMP Inspection and Reporting Tables (WERF 2005)

### Vegetation Management

**Table A-10. Inspection, reporting, and information management for swales and strips (WERF 2005).**

---

*Description: visit site; review comprehensive checklist of items; note and refer problems to maintenance staff; document findings in database.*

---

<i>Frequency</i>		
<b>Default</b>	<b>Once per year</b>	Self-explanatory.
High	Twice per year	Work crews sometimes asked to do informal inspections; formal inspections typically every 3 years. Many agency representatives recommended more frequent, annual inspections for small controls (swales, bioretention, and infiltration trenches) than the standard 3-year cycle for larger ponds and basins.
Medium	Once per year	Typical frequency, especially for agencies with large numbers of BMPs.
Low	No scheduled inspections; respond to citizen complaints	Not recommended. Need more timely observations.
<i>Time required</i>		
<b>Default</b>	<b>2 hours</b>	Includes recording field data into computer database.
Range	1 to 3 hours	Depends on distance and speed of travel between sites, level of detail of reporting required.
<i>Labor</i>		
<b>Default</b>	<b>1 person</b>	Calculate cost by multiplying the number of persons times local wage rate(s).
Range	1 to 2 persons	Typically one person; some agencies prefer two.
<i>Skill level</i>		
<b>Default</b>	<b>Skilled Professional</b>	Determines wage level.
Range	High school trainee to skilled professional	Dictated by budget; higher turnover typically for lower paid employees; depends on complexity of BMPs.
<i>Equipment and materials</i>		
<b>Default</b>	<b>Vehicle; field data form; computer database</b>	Determines equipment cost. Select an hourly expense.
Range	See above; also digital camera and Global Positioning System devices to record and track control locations.	Depends on level of sophistication desired.

---

**Table A-11. Vegetation management with trash and minor debris removal for swales and strips (WERF 2005).**

*Description: mow grounds; cut small woody vegetation to prevent unwanted tree growth. Walk or drive site; pick up obvious litter; informal inspection: check outfalls for blockage and notify maintenance staff if significant problems are observed.*

<i>Frequency</i>		
<b>Default</b>	<b>Once per year</b>	Self-explanatory.
<b>High</b>	Every 4 to 6 weeks	Done for aesthetics, especially for controls with high public visibility; not required in low rainfall areas (except, possibly, trash control component). Commercial areas often maintain on same schedule as rest of grounds.
<b>Medium</b>	Once or twice per year	Typical frequency. Aesthetics still is impetus; depends on community expectations, rainfall level, and plant growth rate.
<b>Low</b>	Every 3 years, plants selected for slow growth	Minimum required to ensure woody plants do not compromise flow path and outfall areas. Use of native grasses and/or wetland plants can potentially decrease maintenance frequency.
<i>Time required</i>		
<b>Default</b>	<b>4 hours</b>	Assumes small (2-person) crew. Larger crew could maintain an "average"-sized facility more quickly. Each agency strikes its own balance.
<b>Range</b>	2 to 5 hours per crew per facility	Depends largely on the size of control site and level of maintenance, distance and speed of travel between sites, and size and equipment of crew. Large equipment may slow transport between sites. Supervisor spends fraction of time at each site.
<i>Labor</i>		
<b>Default</b>	<b>2 persons</b>	Calculate cost by multiplying number of persons times local wage rate(s). If contracted, use lump sum.
<b>Range</b>	1 to 5 workers plus supervisor	Depends on equipment used and level of maintenance. Large one-person mowers used by some; minimal maintenance site requires much less labor than manicured site.
<i>Equipment and materials</i>		
<b>Default</b>	<b>Truck, trailer, tractor with mower, miscellaneous landscaping tools.</b>	Determines equipment cost. Select an hourly expense.
<b>Typical</b>	See above; equipment varies.	Greatly varies on size of BMPs, budget, and level of maintenance desired. Some agencies much more tolerant of plant growth on site.
<b>Options</b>	Public crew vs contracted services	Market-driven factors determine choice. Both inhouse labor and subcontracted labor used by agencies interviewed. Usually maintained by property owners except in public property or rights-of-way.

**Table A-12. Intermittent maintenance for swales and strips (WERF 2005).**

---

*Description: miscellaneous maintenance to repair nonroutine problems: repair eroded side slopes, correct geometry (channelization, lack of flow spreaders, etc.), remove sediment, restore landscaping elements, and repair animal damage.*

---

<i>Frequency</i>		
<b>Default</b>	<b>Every 4 years</b>	Local conditions (drainage area stability, soils, etc.) will dictate frequency; need to establish long-term averages based on local experience.
High	Every 1 to 2 years	Recommended level in some maintenance guidelines; small number of agencies use this frequency in practice. Caltrans requires annual sediment removal.
Medium	Every 5 to 8 years	More typical frequency. Montgomery County estimates sediment removal every 5 years.
Low	No maintenance (Assume every 10 years for cost model)	Most systems have received no maintenance to date; not an acceptable long-term strategy—will diminish performance.
<i>Time required</i>		
<b>Default</b>	<b>1 day</b>	Varies with project size and complexity from 1 hour to several days or more per activity.
Range	4 hours to 2 days	Depends greatly on size and accessibility of control, quantity of sediment, weather, location of disposal site, etc. Long-term averages should be established based on local data.
<i>Labor</i>		
<b>Default</b>	<b>4 persons</b>	Crew size varies by agency and project. Calculate cost by multiplying number of persons times local wage rate(s). If contracted, use lump sum.
Range	3 to 6 workers plus supervisor	Depends on equipment used and level of maintenance.
<i>Equipment and materials</i>		
<b>Default</b>	<b>Backhoe; dump truck; miscellaneous hand tools</b>	Equipment and materials vary by agency, project size, and complexity.
Typical	Front-end loader, backhoe, dump truck, trailer for vehicles, miscellaneous hand tools, replacement components.	Dependent on size of control, equipment available, and facility design. Controls with no provision for maintenance will require ad hoc measures for access, raising costs and project lengths.

---



## Wet Ponds

**Table A-13. Summary method to estimate effort for inspection, reporting, and information management for wet ponds (WERF 2005).**

---

*Description: visit site; review comprehensive checklist of items; note and refer problems to maintenance staff; document findings in database.*

---

<i>Frequency</i>		
<b>Default</b>	Every 3 years	Self-explanatory.
High	Twice per year & following large rainfall events	Work crews sometimes asked to do informal inspections; formal inspections usually every 3 years.
Medium	Every year	Typical frequency, esp. for agencies with large numbers of BMPs.
Low	Every 3 years	Not recommended. Need more timely observations.
<i>Time required</i>		
<b>Default</b>	<b>2 hours</b>	Includes recording field data into computer database.
Range	1 to 3 hours	Depends on distance and speed of travel between sites, level of detail of reporting required.
<i>Labor</i>		
<b>Default</b>	<b>1 person</b>	Calculate cost by multiplying number of persons times local wage rate(s).
Range	1 to 2 persons	Typically one person. Some agencies prefer two.
<i>Skill level</i>		
<b>Default</b>	<b>Skilled Professional</b>	Determines wage level.
Range	High school trainee to graduate student to skilled professional	Dictated by budget; higher turnover typically for lower paid employees; depends on complexity of BMPs.
<i>Equipment and materials</i>		
<b>Default</b>	<b>Vehicle; field data form; computer database</b>	Determines equipment cost. Select an hourly expense.
Range	See above; also digital camera and Global Positioning System devices to record and track control locations.	Depends on level of sophistication desired.

---

**Table A-14. Summary of vegetation management and trash and minor debris removal for wet ponds (WERF 2005).**

*Description: mow grounds; cut small woody vegetation to prevent unwanted tree growth. May or may not include significant care of aquatic vegetation. Walk or drive site; pick up obvious litter; informal inspection: check outfalls for blockage and notify maintenance staff if significant problems are observed.*

<i>Frequency</i>		
<b>Default</b>	Once per year	Assumes not in high visibility area.
<b>High</b>	Every 4 to 6 weeks	Done for aesthetics, especially for BMPs with high public visibility; not required in low rainfall areas (except possibly trash control component). Commercial areas often maintain on same schedule as rest of grounds.
<b>Medium</b>	Once or twice per year	Typical frequency. Aesthetics still is impetus; depends on community expectations, rainfall level, plant growth rate.
<b>Low</b>	Every 3 years, limited area mowed, plants selected for slow growth	Minimum required to ensure woody plants do not take over embankment and outfall areas. Can mow perimeter, embankment, and access points only if desired. Use of native plants can improve appearance. May have to target "problem ponds" for more frequent maintenance.
<i>Time required</i>		
<b>Default</b>	8 hours	Assumes small (2-person) crew. Larger crew could maintain an "average"-sized facility more quickly. Each agency strikes its own balance.
<b>Range</b>	4 to 16 hours per crew per facility	Depends greatly on size of control and level of maintenance, distance and speed of travel between sites, and size and equipment of crew. Aquatic vegetation maintained at some sites in boat; others not at all; extensive care of aquatic plants could require substantially more time and cost. Large equipment may slow transport between sites. Supervisor spends fraction of time at each site.
<i>Labor and labor rate</i>		
<b>Default</b>	2 persons	Calculate cost by multiplying number of persons times local wage rate(s). If contracted, use lump sum.
<b>Range</b>	1 to 5 workers plus supervisor	Depends on equipment used and level of maintenance. Large one-person mowers used by some; minimal maintenance site requires much less labor than manicured site. Labor wage rates vary considerably across the country.
<i>Equipment and materials</i>		
<b>Default</b>	Truck, trailer, tractor with mower, miscellaneous landscaping tools.	Determines equipment cost. Select an hourly expense.
<b>Typical</b>	See above; equipment varies. Boat or aquatic vehicle required to remove trash and plants from pool area.	Greatly varies on size of BMPs, budget, and level of maintenance desired. Some agencies much more tolerant of plant growth (including trees) in pond and on-site.
<b>Options</b>	Public crew vs contracted services	Market-driven factors determine choice. Both inhouse labor and subcontracted labor used by agencies interviewed.

## Dry Extended Detention Ponds

**Table A-15. Vegetation management with trash and minor debris removal for dry extended detention ponds (WERF 2005).**

*Description: Mow grounds; cut small woody vegetation to prevent unwanted tree growth. Walk or drive site; pick up obvious litter; informal inspection: check outfalls for blockage and notify maintenance staff if major problems observed.*

<i>Frequency</i>		
<b>Default</b>	<b>Once per year</b>	Self-explanatory.
<b>High</b>	Every 4 to 6 weeks	Done for aesthetics, esp. for BMPs with high public visibility; not required in low rainfall areas (except possibly trash control component). Commercial areas often maintain on same schedule as rest of grounds.
<b>Medium</b>	Once or twice per year	Typical frequency. Aesthetics still is impetus; depends on community expectations, rainfall level, plant growth rate.
<b>Low</b>	Every 3 years, limited area mowed, plants selected for slow growth	Minimum required to ensure woody plants do not take over embankment and outfall areas. Can mow perimeter, embankment, and access points only if desired. Use of native plants can improve appearance. May have to target "problem ponds" for more frequent maintenance.
<i>Time required</i>		
<b>Default</b>	<b>4 hours</b>	Assumes small (2 person) crew. Larger crew could maintain an "average" sized facility more quickly. Each agency strikes its own balance.
<b>Range</b>	2 to 5 hours per crew per facility	Depends greatly on size of control & level of maintenance, distance and speed of travel between sites, and size and equipment of crew. Large equipment may slow transport between sites. Supervisor spends fraction of time at each site.
<i>Labor</i>		
<b>Default</b>	<b>2 persons</b>	Calculate cost by multiplying number of persons times local wage rate(s). If contracted, use lump sum.
<b>Range</b>	1 to 5 workers plus supervisor	Depends on equipment used and level of maintenance. Large one-person mowers used by some; minimal maintenance site requires much less labor than manicured site.
<i>Equipment and materials</i>		
<b>Default</b>	<b>Truck, trailer, tractor with mower, miscellaneous landscaping tools.</b>	Determines equipment cost. Select an hourly expense.
<b>Typical</b>	See above; equipment varies.	Greatly varies on size of BMPs, budget, and level of maintenance desired. Some agencies much more tolerant of plant growth on site.
<b>Options</b>	Public crew vs contracted services	Market-driven factors determine choice. Both in-house labor and subcontracted labor used by agencies interviewed.

**Table A-16. Summary method to estimate costs for inspection, reporting, and information management for media filters (WERF 2005).**

---

*Description: Visit site; review comprehensive checklist of items; note and refer problems to maintenance staff; document findings in database.*

---

<i>Frequency</i>		
<b>Default</b>	Every year	Self-explanatory.
<b>High</b>	Twice per year and following large rainfall events	Work crews sometimes asked to do informal inspections; formal inspections typically every year.
<b>Medium</b>	Every year	Typical frequency, especially for agencies with large numbers of BMPs.
<b>Low</b>	No scheduled inspections; respond to citizen complaints	Not recommended. Need more timely observations.
<i>Time required</i>		
<b>Default</b>	<b>2 hours</b>	Includes recording field data into computer database.
<b>Range</b>	1 to 3 hours	Depends on distance and speed of travel between sites, level of detail of reporting required.
<i>Labor</i>		
<b>Default</b>	<b>1 person</b>	Calculate cost by multiplying number of persons times local wage rate(s).
<b>Range</b>	1 to 2 persons	Typically one person. Some agencies prefer two.
<i>Skill level</i>		
<b>Default</b>	<b>Skilled Professional</b>	Determines wage level.
<b>Range</b>	High school trainee to graduate student to skilled professional	Dictated by budget; higher turnover typically for lower paid employees; depends on complexity of BMPs.
<i>Equipment and materials</i>		
<b>Default</b>	<b>Vehicle; field data form; computer database</b>	Determines equipment cost. Select an hourly expense.
<b>Range</b>	See above; also digital camera and Global Position System devices to record and track control locations.	Depends on level of sophistication desired.

---



## Filter Maintenance

**Table A-17. Filter maintenance for media filters (WERF 2005).**

---

*Description: Replace surface layer of filter media from basin and haul away to disposal site.*

---

*Frequency*

<b>Default</b>	Every 3 years	Local conditions (drainage area stability, soils, etc.) will dictate frequency; need to establish long-term averages based on local experience. Each filter will have its own periodicity.
High	Every 1 to 2 years	Watersheds with unstabilized channels or construction activity
Medium	Every 3 years	Frequency observed in previous sand filter studies
Low	Every 7 years	Very stable watershed

*Time required*

<b>Default</b>	2 days	Actual figure will greatly depending on facility size, quantity of media, and other factors.
Range	2 to 5 days	Depends greatly on size and accessibility, quantity of media, weather, location of disposal site, etc. Long-term averages should be established based on local data.

*Labor*

<b>Default</b>	2.5 persons	Calculate cost by multiplying number of persons times local wage rate(s). If contracted, use lump sum.
Range	2 to 5 workers plus supervisor	Depends on equipment used and size & complexity of projects.

*Equipment and materials*

<b>Default</b>	Pickup truck, trailer, miscellaneous hand tools.	Assume control with adequate access (i.e., does not have to be provided to maintain).
Typical	See above. May use excavator for large projects and/or for difficult access.	Dependent on size of controls, equipment available, and facility design. Controls with no provision for maintenance will require ad hoc measures to remove media, raising costs and project lengths.

*Description: replace entire media bed*

<b>Default</b>	Every 10 years	Local conditions (drainage area stability, soils, etc.) will dictate frequency; need to establish long-term averages based on local experience. Each filter will have its own periodicity.
High	Every 3 years	Watersheds with unstabilized channels or construction activity.
Medium	Every 10 years	Frequency observed in previous sand filter studies.
Low	Every 15 years	Very stable watershed.

*Time required*

<b>Default</b>	5 days	Actual figure will greatly depend on facility size, quantity of media, and other factors.
Range	4 to 7 days	Depends greatly on size and accessibility, quantity of media, weather, location of disposal site, etc. Long-term averages should be established based on local data.

*Labor*

<b>Default</b>	2.5 persons	Calculate cost by multiplying number of persons times local wage rate(s). If contracted, use lump sum.
Range	2 to 5 workers plus supervisor	Depends on equipment used and size & complexity of projects.

*Equipment and materials*

<b>Default</b>	Bobcat, dump truck, pickup truck, trailer, miscellaneous hand tools.	Assume control with adequate access (i.e., does not have to be provided to maintain).
Typical	See above. May use excavator for large projects and/or for difficult access.	Dependent on size of BMPs, equipment available, and facility design. Controls with no provision for maintenance will require ad hoc measures to remove media, raising costs and project lengths.

---

## Infiltration Trenches

**Table A-18. Trash and minor sediment and debris removal for infiltration trenches (WERF 2005).**

---

*Description: walk site; pick up obvious litter; informal inspection: notify maintenance staff if significant problems observed.*

---

<i>Frequency</i>		
<b>Default</b>	<b>Once per year</b>	Self-explanatory.
<b>High</b>	Every 4 to 6 weeks	Done for aesthetics, especially for BMPs with high public visibility. Commercial areas often maintain on same schedule as rest of grounds.
<b>Medium</b>	Once or twice per year	Typical frequency. Aesthetics still is impetus; depends on community expectations.
<b>Low</b>	No maintenance (Assume minimum every 3 years for planning purposes)	Many systems are not maintained at any level. Trash and debris may be an indicator of larger problems with sedimentation and should be removed.
<i>Time required</i>		
<b>Default</b>	<b>1 hour</b>	Most infiltration trenches are small; most of the time spent will be driving in between sites.
<b>Range</b>	0.5 to 2 hours	Depends greatly on size of control and level of maintenance, distance and speed of travel between sites, and size and equipment of crew. Large equipment may slow transport between sites. Supervisor spends fraction of time at each site.
<i>Labor</i>		
<b>Default</b>	<b>1 person</b>	Calculate cost by multiplying number of persons times local wage rate(s). If contracted, use lump sum.
<b>Range</b>	1 to 2 workers plus supervisor	Small facilities typically require small crew to maintain.
<i>Equipment and materials</i>		
<b>Default</b>	<b>Truck.</b>	Determines equipment cost. Select an hourly expense.
<b>Typical</b>	Truck.	Also need trash bags, etc.
<b>Options</b>	Public crew vs contracted services	Market-driven factors determine choice. Both inhouse labor and subcontracted labor used by agencies interviewed.

---

**Table A-19. Sediment removal for infiltration trenches (WERF 2005).**

<i>Description: remove existing rock media and built-up sediment from control and haul away sediment to disposal site. Install new rock media.</i>		
<i>Frequency</i>		
<b>Default</b>	Every 5 years	Local conditions (drainage area stability, soils, etc.) will dictate frequency; need to establish long-term averages based on local experience. Five years is likely maximum given high failure rate within 5 years.
High	Every 1 to 2 years	Recommended level in some maintenance guidelines; small number of agencies use this frequency in practice. Caltrans requires annual sediment inspection and removal.
Medium	Every 3 to 5 years	More typical frequency. Montgomery County estimates sediment removal every 5 years.
Low	No maintenance (Assume minimum every 5 years for planning purposes)	Most systems have received no maintenance to date; not an acceptable long-term strategy: high percentage of all systems fail within 5 years and need to be restored by removing sediment and replacing media to function.
<i>Time required</i>		
<b>Default</b>	3 days	Actual figure will greatly depend on facility size, quantity of sediment, and other factors. Three days assumes 1 day to excavate; 1 day to replace media; 1 day to seed, stabilize, and restore site per Montgomery County experience.
Range	2 to 4 days	Depends greatly on size and accessibility of controls, quantity of sediment, weather, location of disposal site, etc. Long-term averages should be established based on local data.
<i>Labor</i>		
<b>Default</b>	Five persons	Calculate cost by multiplying number of persons times local wage rate(s). If contracted, use lump sum.
Range	Approximately five workers plus supervisor	Depends on equipment used and size & complexity of projects.
<i>Equipment and materials</i>		
<b>Default</b>	Backhoe; dump truck; miscellaneous hand tools	Assume control with adequate access (i.e., does not have to be provided to maintain).
Typical	Backhoe; dump truck; miscellaneous hand tools	Dependent on size of control, equipment available, and facility design.
<i>Options</i>	Public crew vs contracted services	Market-driven factors determine choice.

## Street Sweeping

**Table A-20. Street sweeping and trash and minor debris removal practices for pervious pavement (WERF 2005).**

<i>Description: walk site; pick up obvious litter; informal inspection: notify maintenance staff if significant problems observed; remove sediment with vacuum sweeper.</i>		
<i>Frequency</i>		
<b>Default</b>	Once per year	Self-explanatory.
High	Every 4 to 6 weeks	Done for aesthetics (e.g., at high-use commercial sites).
Medium	Once or twice per year	Standard level of vacuuming specified.
Low	No maintenance (Assume minimum every 3 years for planning purposes)	Many systems are not vacuumed; risks diminished performance and need for significant repair and expense.
<i>Estimated cost</i>		
<b>Default</b>		Data not available from agencies.
High		Data not available from agencies.
Medium		Data not available from agencies.
Low		Many systems have received no maintenance to date, but will likely compromise long-term function of system.
<i>Options</i>	Public crew vs contracted services	Market-driven factors determine choice. Both inhouse labor and subcontracted labor used by agencies interviewed.

## Pervious Pavement

**Table A-21. Intermittent facility maintenance: structural repairs for pervious pavement (WERF 2005).**

---

*Description: periodic repair of pavement surface damaged by traffic wear, soil movement, etc.*

---

*Frequency*

Default	N/A: Variable. As required based on inspection findings (and budget)	Wide variety of pavement types, traffic patterns, and climate and soil conditions make general predictions difficult.
---------	--	---

*Time required*

N/A	Wide variation	Varies with project size and complexity from 1 hour to several days or more.
-----	----------------	--

*Labor*

Default	N/A: Inherently variable	Crew size varies by agency and project. Local wage rate(s) determine labor cost.
Range	3 to 6 workers plus supervisor	Depends on equipment used and level of maintenance.

*Equipment and materials*

Default	N/A: Inherently variable	Equipment and materials vary by agency and project.
Typical	Front-end loader, backhoe, dump truck, trailer for vehicles, miscellaneous hand tools, replacement components.	Varies with project size and complexity.

*Estimated cost*

Default		Data not available from agencies.
High		Data not available from agencies.
Medium		Data not available from agencies.
Low		Many systems have received no maintenance to date; but some level of problems must be anticipated and budgeted for.
<i>Options</i>	Public crew vs contracted services	Market-driven factors determine choice. Most agencies used inhouse labor.

---

*Description: remove sediment from control and haul away sediment to disposal site.*

---

*Frequency*

Default	Every 15 years	Use as placeholder to establish cost. Local conditions (landscaping practices, soils, etc.) and system type will dictate frequency; need to establish long-term averages based on local experience.
Range	0 to 20 years	Many systems not maintained. Favorable soils will help life span of system prior to needing sediment removal. Landscaping practices (keeping sediment off pavement) and traffic wear are main factors in frequency of sediment removal required.

---



## Catch Basin Cleaning

Many municipalities, especially those with combined sewer systems, have catch basins that maintain a permanent pool of water. These inlets retain sediment and floatables, which must be periodically removed. As material accumulates in the catch basin, pollutant retention decreases. According to Aronson et al. (1983), catch basins should be cleaned. It is also a good idea to inspect and clean all catch basins that serve as a tributary to a wet basin or wetland when that facility is cleaned to reduce sediment loading to the fore bay. One study of catch basins in Alameda County, California, found that increasing the maintenance frequency from once per year to twice per year could increase the total sediment removed by catch basins

on an annual basis (Mineart and Singh 1994). The study found that annual sediment removed per inlet was 25 kg (54 lb) for annual cleaning, 32 kg (70 lb) for semiannual and quarterly cleaning, and 73 kg (160 lb) for monthly cleaning. Although catch basins are relatively inexpensive to install, the real cost is associated with long-term maintenance cost. An educator truck (or Vactor truck), the most common method of catch basin cleaning, can cost up to \$250,000 (U.S. dollars). Typical trucks can store between 10 and 15 m<sup>3</sup> (10 and 15 cu yd) of material, which is enough storage for three to five catch basins (WERF 2005). Typically, using a crew of two, the average catch basin takes 30 minutes to clean. Severely polluted catch basins, which typically result from illegal dumping, may take several days of repeated cleaning. (WEF 2012, p. 478)

## APPENDIX B

## Simple and Complex Assessment Methods and Worked Example

**Overview of Appendix**

This appendix provides two methods, the *simple assessment* and *complex assessment* to estimate the impact of a bridge crossing on receiving water quality and illustrates the dilution calculations. This appendix also provides a worked example problem that uses the entire recommended procedure in the Guide (except the simple and complex examples, previously provided), moving through a bridge analysis in a step-wise example to illustrate the use of the guide, the BMP Evaluation Tool, and the Conveyance Cost Tool.

**Effect of Bridge Deck Runoff on the Receiving Water**

One of the largest factors likely to reduce the impact of bridge runoff on receiving waters is dilution. Evaluation of impacts of runoff in general, and that from bridge structures in particular, hinges on the estimation of the concentration of a constituent in the receiving watercourse downstream of the bridge. Methods for carrying this out have been reviewed and summarized in several key references, notably *NCHRP Report 474* (TRB 2004) and URS (2010). In the present context, we present approximations that will serve as “screening estimates”, exploiting the characteristics of bridge discharges to simplify the computation in the majority of cases while remaining justifiable and consistent with regulation. The strategy is to specify *strongly conservative* estimates, i.e., those that will entail maximum impacts of the bridge runoff, and compare these estimates to regulatory thresholds. We emphasize two aspects of each such screening calculation: the data necessary to complete the calculation and the assumptions underlying the formula, which implicitly delimit conditions for which the calculation is appropriate.

Generally, the concentration  $c$  in some volume of influence  $V$  in the receiving water is given as a statement of conservation of mass:

$$\frac{d(Vc)}{dt} = c_a Q_a + c_s Q_s - cQ + EA c - KcV \quad (1)$$

where

- $Q_a$  = ambient flow in the watercourse
- $c_a$  = ambient concentration in the watercourse
- $Q_s$  = storm runoff flow into the watercourse
- $c_s$  = storm runoff concentration
- $E$  = evaporation rate in depth of water per unit time
- $A$  = surface area of the volume of influence
- $K$  = first-order decay coefficient in inverse time (i.e., per unit time)

The outflow from  $V$  is given approximately by:

$$Q = Q_a + Q_s - EA \quad (2)$$

Concentration is usually a mass ratio, i.e., mass of constituent per unit mass of water, but in water quality evaluations of dilute concentrations in natural watercourses, concentration is typically expressed as the ratio of mass of constituent per unit volume of water, e.g., mg/L. In this case, the products  $c_a Q_a$  and  $c_s Q_s$  are the loads in the watercourse and the storm runoff, respectively. The concentration  $c$  is a spatial mean assumed to be averaged in some way over the volume  $V$ , but better definition of  $V$  will be dependent upon the watercourse and the objective of the estimate, as will be seen. The pollutants of concern in evaluating the impact of bridge deck runoff remain behind in the watercourse when water is lost to evaporation, thereby increasing their concentrations. The term  $EAc$  represents the effective mass source from this process. The last term  $-KcV$  is a first-order decay, which can

**B-2**

depict the in-stream kinetics to which some constituents, such as nitrogen compounds and coliforms, are subjected.

If  $K$ ,  $c_a$ ,  $Q_a$ ,  $E$ ,  $c_s$ , and  $V$  are taken constant, and  $Q_s$  is the averaged storm flow over the time from  $0$  to  $t$ , the solution to (1) is:

$$c(t) = \frac{c_a Q_a + c_s Q_s}{(R+K)V - EA} (1 - e^{-(R+K-EA/V)t}) + c_o e^{-(R+K-EA/V)t} \quad (3)$$

where  $R \equiv Q/V$  and  $c_o \equiv c(0)$  for which  $c_o = c_a$  is a realistic value for an isolated event. It should be noted that  $R$  is the reciprocal of the residence time  $\tau$  for the volume of influence (see Section 3.1.1). Frequently, a practical approximation is that of a steady-state balance, i.e.,  $d(Vc)/dt \rightarrow 0$  in (1), whereupon (3) reduces to:

$$c(t) = \frac{c_a Q_a + c_s Q_s}{(R+K)V - EA} \quad (4)$$

These equations apply in general to a storm event in which the runoff is from the entire area affected by the storm, of which the bridge deck is one component. (These separate components, of which the bridge is only one, are examined in the next paragraph.) If the pollutant is unique to the bridge deck, that is, the bridge deck is the only source of the pollutant in the storm runoff, then  $c_s$  and  $Q_s$  in (3) and (4) apply solely to the load from the bridge. The solutions (3) and (4) can be exploited for order-of-magnitude estimates. A version of (4) is presented in Method 2 of *NCHRP Report 474* (TRB 2004) for salts, in which  $K$  and  $E$  do not appear.

We can estimate the magnitude of the dilution process by separating the storm runoff in the watercourse downstream of the bridge into areal components, *viz.* that precipitation  $Q_p$  falling directly on the surface of the watercourse upstream from the bridge structure (which, technically, is not runoff), runoff from the adjacent drainage area  $Q_d$  likewise upstream from the bridge, and that running off from the bridge structure  $Q_b$  itself,

$$Q_s = Q_p + Q_d + Q_b \quad (5)$$

For a constant rate of precipitation, it is immediate that the relative magnitudes of these flows are proportional to the *effective area* of each component. The constant of proportionality (i.e., runoff coefficient) is a fraction generally less than 1. A bridge deck is assumed impermeable with no ponding areas, so a value of 1 is adopted. Clearly, for precipitation directly on the water surface, this coefficient equals 1. For an urbanized drainage area the coefficient ranges from 0.7–1.0, so a value of 0.8 is recommended. For a rural drainage area, the coefficient can range from 0.0 to nearly one, depending

upon the condition of the landscape and soils. Absent region-specific information, a value of 0.3 is suggested.

“Effective area” means the intersection of the area of precipitation and the surface area of each areal component. The area of precipitation is the “footprint” of the convective storm system giving rise to the precipitation. For deep-convecting systems, precipitation is concentrated in single thunderstorm cells or clusters of cells. The precipitation area is a combination of the time history of precipitation from the convective cells and the trajectory of movement. At the low end of the size spectrum, these cells are air-mass thunderstorms, typical of summer in most of the United States, but in some regions of the country the primary source for rainfall. On average, these single cells are about 30 km<sup>2</sup> in area, and rarely smaller than 20 km<sup>2</sup> (e.g., Morin 2006). At the other end of the spectrum, “supercell” thunderstorms have precipitation areas ranging up to the order of 10<sup>4</sup> km<sup>2</sup> (e.g., Smith 2001, Bluestein, 2009). Mesoscale convective complexes (MCCs) are clusters of cells exceeding specified thresholds of size and intensity that are longer lived than single-cell storms. These MCCs have areas of significant precipitation about 10<sup>6</sup> km<sup>2</sup> (Kane 1987). At the largest scale are the precipitation patterns associated with synoptic systems, such as cyclonic storms, frontal passages and squall lines, whose lifetime trajectories can extend over several states to much of North America, and whose precipitation areas can range up to 10<sup>8</sup> km<sup>2</sup> or more.

For order-of-magnitude estimates of Equation (5), consider a watercourse of width 100 m and length upstream from the bridge crossing of 100 km. The order of bridge deck dimensions would be 100 m length (the same order as the watercourse width) and 10 m width, so its area is 10<sup>-3</sup> km<sup>2</sup>. Precipitation areas for all meteorological systems described above exceed the bridge deck area, so for the bridge the effective area is the bridge deck itself, 10<sup>-3</sup> km<sup>2</sup>. The upstream surface area of the watercourse is its width times its length, 10 km<sup>2</sup>. While this is exceeded by the precipitation areas of all of the above meteorological systems, the smallest, the air-mass thunderstorm, is of the same order, but of a circular rather than rectilinear geometry. The radius of the cell is one-tenth the dimension of the upstream watercourse length, so the effective area is about 10 km length times 100 m width, or 1 km<sup>2</sup>. For the larger meteorological systems, the effective area is the upstream surface area of the watercourse, 10 km<sup>2</sup>. Finally, the nominal area of the upstream watershed is the square of upstream watercourse length, or 10<sup>4</sup> km<sup>2</sup>. For single-cell storms, ranging from air-mass to super cell, the watershed area is on the same order or larger than the precipitation area, so the effective area is that of the storm, ranging 10–10<sup>4</sup> km<sup>2</sup>. The larger meteorological systems are orders of magnitude larger than the watershed, so the effective area

**Table B-1. Comparative example orders of magnitude for flow components of Equation (5).**

Source of runoff	Meteorological Precipitation System	Area (km <sup>2</sup> )
Bridge Deck (Q <sub>b</sub> )	All	10 <sup>-3</sup>
Upstream Surface of Watercourse (Q <sub>p</sub> )	Airmass Cell	1
	Others	10
Upstream Watershed (Q <sub>d</sub> )	Single-Cell Storms	10-10 <sup>4</sup>
	Others	10 <sup>4</sup>

becomes that of the watershed, 10<sup>4</sup> km<sup>2</sup>. In summary, the orders of magnitude of the terms in Equation (5) are given in Table B-1.

Clearly, the contribution of bridge runoff to the total storm flow given by Equation (1) is at least three orders of magnitude smaller than the other terms. That the bridge runoff is negligible compared to the other terms is unaffected by considering a bridge deck of greater width, and to assuming smaller values of the runoff coefficient for the upstream watershed, and is equally applicable to the stream, arm of a lake, or arm of an estuary. For larger watercourse systems, the watershed area scales with the upstream length, while bridge dimensions scale with watercourse width, so similar orders of magnitude result. Even though concentrations of various constituents in bridge deck runoff can be elevated compared to those measured in the receiving water, the actual impact would be expected to be small because of the relative volumes of runoff illustrated in Table B-1.

This is an expected result based on mass balance of constituent and hydrologic inputs because the bridge is such a small fraction of the watershed. In addition to the water balance, a comparison of the associated pollutant loads can be made, if estimates of the constituent concentrations are available. For short residence times (i.e., large *R*), the reactive rates *EA/V* and *K* may be neglected in comparison to *R*. With concentrations *c<sub>p</sub>*, *c<sub>d</sub>*, and *c<sub>b</sub>* assigned to each of *Q<sub>p</sub>*, *Q<sub>d</sub>*, and *Q<sub>b</sub>*, resp., the flow-weighted concentration upstream from the bridge:

$$c_u = (c_a Q_a + c_p Q_p + c_d Q_d) / (Q_a + Q_p + Q_d)$$

and the dilution of the bridge runoff defined to be  $D \equiv Q/Q_b$ , (4) becomes:

$$c = c_u \left(1 - \frac{1}{D}\right) + c_b \frac{1}{D} \tag{6}$$

or, in perhaps a more transparent form:

$$c - c_u = \frac{(c_b - c_u)}{D}$$

Equation (6) is a suitable screening test. For storm runoff from even a small single-cell storm, the comparative magnitudes of Table B-1 indicate that *D* is about 10<sup>4</sup>. The ratio of *c<sub>b</sub>* to *c<sub>u</sub>* would therefore have to approach this order to be problematic for acute concentrations. In such a situation, the more accurate Equations (3) or (4) should be used with better estimates of stream flow and runoff magnitudes. If we assume that the concentration in bridge runoff is as much as an order of magnitude greater than that in the precipitation and storm runoff loads, then the bridge runoff load *c<sub>b</sub>Q<sub>b</sub>* is at least two orders of magnitude smaller than either of the load to the stream in rainfall directly on the water surface *c<sub>p</sub>Q<sub>p</sub>* or the load from upstream runoff *c<sub>d</sub>Q<sub>d</sub>*. The general conclusion must be that the impact of runoff from any individual bridge in a rural area on the receiving water is de minimis.

This qualitative conclusion is supported by a scenario from a bridge crossing in Texas. Malina et al. (2005) evaluated the load increase associated with the Loop 360 bridge discharge to Barton Creek in Austin, Texas. This site was selected as a worst-case scenario, because it was a six-lane bridge discharging to an ephemeral stream (big bridge/stream with small flow). Average annual loads were calculated based on typical flow rates and average precipitation. The watershed tributary to this crossing is about 120 square miles, with a 30,000 ft<sup>2</sup> bridge deck. The watershed however, is largely undeveloped, with wet season flows averaging about 25 cfs at the crossing.

Table B-2 summarizes the findings from this Austin, Texas study. For no constituent was the increase downstream of the bridge even as large as 0.1% and most were smaller by at least a factor of 10. These data indicate that even if all discharge from the bridge were eliminated, the change in receiving water quality downstream of the bridge would be undetectable. This suggests that under most conditions, bridge runoff has a de minimis impact on water quality that does not require the installation of BMPs.

As mentioned previously, it is likely that any impairment in an urban watershed is probably associated with impervious cover and it is the cumulative impact of many small contributors that creates the problem. Consequently, the de minimis argument does not apply and bridges should generally have



**Table B-2. Comparison of average storm flow loads in Barton Creek at the Loop 360 Bridge, Austin, TX.**

(Modified from Malina et al., 2005)

Constituent	Annual Load Barton Creek Upstream of Loop 360 Bridge (kg/yr)	Annual Load Contributed by Loop 360 Bridge Runoff (kg/yr)	% Increase
Copper, Total	214	0.04	0.018
Lead, Total	135	0.023	0.017
Zinc, Total	680	0.38	0.056
Nitrate, as N	10,625	0.79	0.007
Total N	47,610	3.03	0.006
COD	9.44 x 10 <sup>5</sup>	77	0.008
Phosphorus, Total	6,165	0.26	0.004
Phosphorus, Dissolved	2,148	0.19	0.008
TSS	7.0 x 10 <sup>6</sup>	258	0.004
VSS	2.64 x 10 <sup>5</sup>	52	0.02
Fecal Coliform (cfu/yr)	1.13 x 10 <sup>16</sup>	1.16 x 10 <sup>11</sup>	0.001

to comply with local NPDES requirements regarding stormwater treatment of runoff to the MEP. In this case, installing structural BMPs on bridges is probably the correct decision for urban watersheds, although feasibility will be affected by cost and limited area to work with: The DOT may find that equivalent or better pollutant removal to the receiving water can be achieved for a lower cost by treating runoff from the adjacent roadway where construction cost and maintenance cost are much more favorable.

**Simple Assessment Procedure**

**Accessing Upstream Water Quality and Flow Data**

The best source of river flow and quality data is a USGS website, which can be accessed at: <http://maps.waterdata.usgs.gov/mapper/index.html>. Zoom in to area of bridge project and locate a monitoring station on the river of interest. If none exists, use another site in the general area. Click on the site to bring up “Site Information.” Figure B-1 shows a screen shot of the map with the monitoring site located on the North Bosque River. Click on “Access Data” on the “Site Information” tab to move to the data selection page, which is presented in Figure B-2.

*Flow Data*

To access average flow data click on “Annual Statistics”, which brings up the page presented in Figure B-3. Click the box next to “Discharge” and select “Table of Annual Means”

under output format. Then click on “Submit”. This brings up the page presented in Figure B-4. These values are easily copied and pasted into Excel to calculate average annual discharge, which is 237 cfs. If the monitoring site is not precisely at the bridge location, then normalize the flow by drainage area, which is 1146 mi<sup>2</sup> in this case resulting in 0.207 cfs/mi<sup>2</sup>. Determine the upstream area at your location of interest and multiply by normalized flow to determine expected discharge at another bridge location.

*Water Quality Data*

To access water quality data from the site, go back to the page shown in Figure B-2 and select “Field/lab water-quality samples,” which brings up the page shown in Figure B-5. Select “Table of Data” with Default attributes and click on “Submit.” This brings up the page shown in Figure B-6, which can be easily copied and pasted into Excel to calculate average values for the constituents of interest. Based on the data provided and using the detection limit for all censored values, the average nitrate concentration is 0.58 mg/L as N and dissolved P is 0.015 mg/L as P.

**Calculation of Constituents of Concern Load Increase**

The load increase is calculated as:

$$\text{Load Increase} = \frac{\text{Bridge Load}}{(\text{Bridge Load} + \text{Upstream Load})} \times 100$$

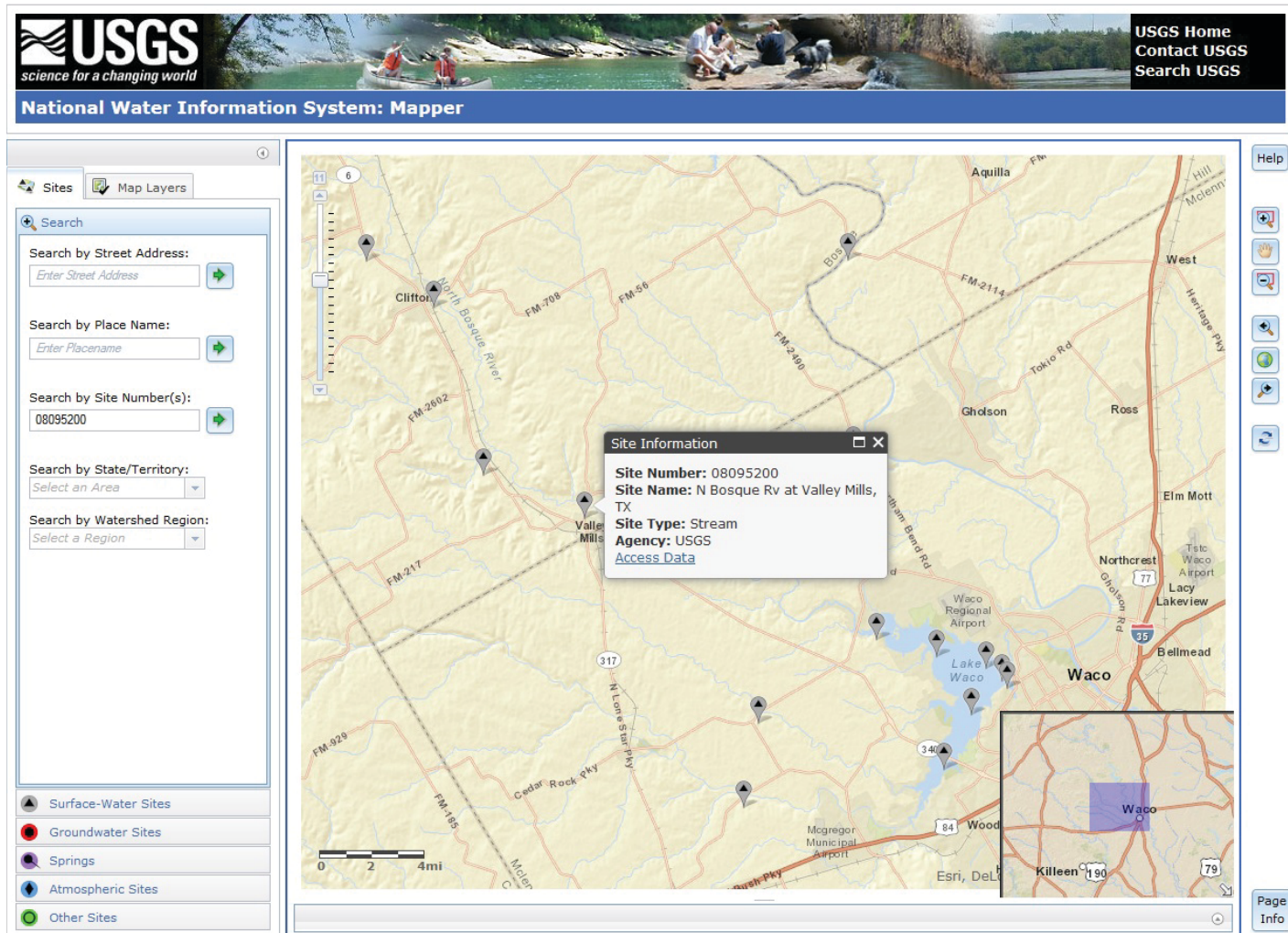

Figure B-1. Screen shot of the USGS mapper.

where the Load Increase is the percentage of the load downstream of the bridge contributed by the bridge itself, Bridge Load is the load conveyed by the bridge runoff, and Upstream Load is the load in the receiving water upstream of the bridge.

$$\text{Bridge Load} = \text{Rainfall} \times \text{Runoff Coefficient} \times \text{Area of the Bridge Deck} \times \text{Concentration}$$

Where the Rainfall is the average annual rainfall for the specific location, the runoff coefficient is typically about 0.9, and the Concentration is the average concentration of the constituent of concern (see Table B-2). This is a low traffic site, so concentrations typical of AADT of 0-25,000 are appropriate. There are many sources of rainfall data, including the performance and cost tool developed as part of this project. Average rainfall in North Central Texas is 29 inches/yr and the area of the bridge is 20,000 ft<sup>2</sup>. Consequently, the Bridge Load for nitrate is:

$$\text{Nitrate Bridge Load} = 29 \text{ in/yr} / 12 \text{ in/ft} \times 1.0 \times 20,000 \text{ ft}^2 \times 0.2 \text{ mg/L} \times 28.3 \text{ L/ft}^3$$

$$\text{Nitrate Bridge Load} = 273,567 \text{ mg/yr} = 0.274 \text{ kg/yr}$$

Similarly, the dissolve P load can be calculated as:

$$\text{DP Bridge Load} = 29 \text{ in/yr} / 12 \text{ in/ft} \times 1.0 \times 20,000 \text{ ft}^2 \times 0.072 \text{ mg/L} \times 28.3 \text{ L/ft}^3$$

$$\text{DP Bridge Load} = 98,433 \text{ mg/yr} = 0.098 \text{ kg/yr}$$

The Nitrate Upstream Load can be calculated as:

$$\begin{aligned} \text{Nitrate Upstream Load} &= \text{Annual discharge of the receiving water} \\ &\times \text{Average Stream Concentration} \end{aligned}$$

$$\text{Nitrate Upstream Load} = 237 \text{ ft}^3/\text{s} \times 86,400 \text{ s/d} \times 365 \text{ d/yr} \times 0.58 \text{ mg/L} \times 28.3 \text{ L/ft}^3$$

$$\begin{aligned} \text{Nitrate Upstream Load} &= 122,678,761,248 \text{ mg/yr} \\ &= 122,679 \text{ kg/yr} \end{aligned}$$

**USGS**  
science for a changing world

National Water Information System: Web Interface

USGS Water Resources

USGS Home  
Contact USGS  
Search USGS

Data Category: Site Information Geographic Area: United States GO

News - updated May 28, 2013

**USGS 08095200 N Bosque Rv at Valley Mills, TX**

Available data for this site: SUMMARY OF ALL AVAILABLE DATA GO

**Stream Site**

**DESCRIPTION:**  
Latitude 31°40'10", Longitude 97°28'09" NAD27  
Bosque County, Texas, Hydrologic Unit 12060204  
Drainage area: 1,146 square miles  
Contributing drainage area: 1,146 square miles  
Datum of gage: 524.55 feet above NGVD29.

**AVAILABLE DATA:**

Data Type	Begin Date	End Date	Count
<a href="#">Current / Historical Observations</a> (availability statement)	2007-10-01	2013-08-02	
<b>Daily Data</b>			
Discharge, cubic feet per second	1959-08-01	2013-08-01	30230
Gage height, feet	1987-10-01	2013-08-01	21459
<b>Daily Statistics</b>			
Discharge, cubic feet per second	1959-08-01	2013-05-19	18626
Gage height, feet	1987-10-01	2013-05-19	8561
<b>Monthly Statistics</b>			
Discharge, cubic feet per second	1959-08	2013-05	
Gage height, feet	1987-10	2013-05	
<b>Annual Statistics</b>			
Discharge, cubic feet per second	1959	2013	
Gage height, feet	1988	2013	
<b>Peak streamflow</b>	1908-05	2012-03-20	56
<b>Field measurements</b>	1959-08-18	2013-07-15	546
<b>Field/Lab water-quality samples</b>	1980-10-22	2008-09-05	68
<b>Additional Data Sources</b>			
<b>Instantaneous-Data Archive</b> **offsite**	1987-10-01	2007-09-30	424578
<b>Annual Water-Data Report (pdf)</b> **offsite**	2005	2012	8

**OPERATION:**  
Record for this site is maintained by the USGS Texas Water Science Center  
Email questions about this site to [Texas Water Science Center Water-Data Inquiries](#)

Figure B-2. Screenshot of the data selection page.

Similarly, the dissolved P upstream load can be calculated as:

$$\text{DP Upstream Load} = \text{Annual discharge of the receiving water} \times \text{Average Stream Concentration}$$

$$\text{DP Upstream Load} = 237 \text{ ft}^3/\text{s} \times 86,400 \text{ s/d} \times 365 \text{ d/yr} \times 0.015 \text{ mg/L} \times 28.3 \text{ L/ft}^3$$

$$\text{DP Upstream Load} = 3,172,726,584 \text{ mg/yr} = 3,173 \text{ kg/yr}$$

The nitrate load increase is given by:

$$\text{Nitrate Load Increase} = 0.274 \text{ kg/yr} / (0.274 \text{ kg/yr} + 122,679 \text{ kg/yr}) \times 100$$

$$\text{Nitrate Load Increase} = 0.0002\%$$

Finally, the dissolved phosphorus load increase is given by:

$$\text{DP Load Increase} = 0.098 \text{ kg/yr} / (0.098 \text{ kg/yr} + 3,173 \text{ kg/yr}) \times 100$$

$$\text{DP Load Increase} = 0.003\%$$

Since the load increase for the constituents of concern, nitrate, and dissolved phosphorus are 0.0002% and 0.003% respectively, which is substantially less than 1%, we can conclude that the impact is de minimus.

### Complex Assessment Procedure

For any of the reasons listed in the main text (Section 3.1.3), the designer may be faced with assessing the impact on the receiving water either by comparison of concentrations with and without the bridge structure, or relative to stream standards



**USGS**  
science for a changing world

National Water Information System: Web Interface

USGS Water Resources

NEWS - updated May 28, 2013

USGS Home  
Contact USGS  
Search USGS

Data Category: Surface Water  
Geographic Area: United States

GO

### USGS Surface-Water Annual Statistics for the Nation

USGS 08095200 N Bosque Rv at Valley Mills, TX

Available data for this site: Time-series: Annual statistics

**Site Selection**  
Select sites which meet all of the following criteria: ---- or select [new criteria](#)

Check one or more boxes to select sites/parameters for further display--below

USGS 08095200 N Bosque Rv at Valley Mills, TX					
	Parameter Code	Parameter Name	Period of Approved Daily-Mean Data (Water Year)		
			From	To	Count
<input checked="" type="checkbox"/>	00060	Discharge, cubic feet per second	1959	2013	18626
<input type="checkbox"/>	00065	Gage height, feet	1988	2013	8561

**Choose Output Format**

Retrieve USGS Surface-Water Annual Statistics for Selected Sites  
Choose one of the following options for displaying data for the sites meeting the criteria above

Date range for statistics calculation of all selected parameters -- From: (YYYY) To: (YYYY)  
If blank, use entire period of record for each parameter.

Use incomplete data for statistics calculation

Annual statistics based on Water Year

Table of annual mean

Tab-separated data YYYY-MM-DD Save to file \*

\* Save compressed files with a .gz file extension.

Submit Reset Help

[Questions about sites/data?](#)  
[Feedback on this web site](#)  
[Automated retrievals](#)  
[Help](#)

[Data Tips](#)  
[Explanation of terms](#)  
[Subscribe for system changes](#)  
[News](#)

Figure B-3. Screenshot of the annual statistics page.

(or some other quantitative criterion for a specific water-quality parameter).

The first step is to determine the applicable stream flow. For water-quality standards, this will be the critical low-flow, typically defined for streams to be the 7Q<sub>10</sub>, or in some states the 7Q<sub>2</sub> or 3Q<sub>10</sub>. (For reservoirs, the 30Q<sub>10</sub> may be the appropriate choice. Unfortunately, these statistics are not routinely provided by the USGS. They have been computed for several states and are available on the Internet (search for “7Q<sub>10</sub>” + the name of the state). They may be computed from daily data at a stream gauge using Windows-based programs, either DFLOW downloadable from the EPA website, or SWSTAT from the USGS website. There are also a script file available for MATLAB application and a macro for EXCEL, both available on the Internet. The first place to check, however, is the water quality regulatory office of the state. Many states publish the computed 7Q<sub>10</sub>s or other regulatory streamflows as a part of their water quality standards. Even though the period of record for which these cal-

culations were made may be long out of date or unknown, without instruction to the contrary from the cognizant state agency, these low-flow statistics should be regarded as jurisdictional.

For the example site of the FM 56 crossing of the North Bosque, this bridge is found to lie in Water Quality Segment 1226, delineated in the State of Texas Surface Water Quality Standards. In an Appendix to the Standards, the 7Q<sub>2</sub> (the statistic used for the low-flow limit for standards application in Texas) throughout this segment is 10.1 cubic feet per second.

The next step is to estimate the rainfall from the event giving rise to storm runoff from the bridge. The worst-case scenario is a small single-cell thunderstorm, say, with area 20 km<sup>2</sup> and rainfall 0.2 inches delivered in an hour or less (because this small a storm will afford minimum dilution). Convective events with rainfalls not exceeding 0.2 inches make up about 75% of storm events in Central Texas and the plateau regions of Texas, e.g., Owens and Lyons (2004).



USGS Home  
Contact USGS  
Search USGS

National Water Information System: Web Interface

USGS Water Resources

Date Category: Surface Water Geographic Area: United States GO

News - updated May 28, 2013

## USGS Surface-Water Annual Statistics for the Nation

The statistics generated from this site are based on approved daily-mean data and may not match those published by the USGS in official publications. The user is responsible for assessment and use of statistics from this site. For more details on why the statistics may not match, [click here](#).

USGS 08095200 N Bosque Rv at Valley Mills, TX

Available data for this site: Time-series: Annual statistics GO

Bosque County, Texas  
Hydrologic Unit Code 12060204  
Latitude 31°40'10", Longitude 97°28'09" NAD27  
Drainage area 1,146 square miles  
Contributing drainage area 1,146 square miles  
Gage datum 524.55 feet above NGVD29

**Output formats**  
[HTML table of all data](#)  
[Tab-separated data](#)  
[Reselect output format](#)

Water Year	00060, Discharge, cubic feet per second
1960	467.8
1961	471.1
1962	243.2
1963	44.5
1964	143.6
1965	463.3
1966	229.4
1967	43.7
1968	627.5
1969	219.1
1970	346.8
1971	38.7
1972	300.4
1973	213.6
1974	67.8
1975	278.8

Figure B-4. Output of annual mean discharges.

USGS Home  
Contact USGS  
Search USGS

National Water Information System: Web Interface

USGS Water Resources

Date Category: Water Quality Geographic Area: United States GO

News - updated May 28, 2013

### Water Quality Samples for the Nation

USGS 08095200 N Bosque Rv at Valley Mills, TX

Available data for this site: Water Quality: Field/Lab samples GO

Bosque County, Texas  
Latitude 31°40'10", Longitude 97°28'09" NAD27  
Gage datum 524.55 feet above NGVD29  
Site Type: Stream

Period of record

Begin Date	End Date	Samples
1980-10-22	2008-09-05	68

**Choose Output Format**

Retrieve Water-Quality Samples for Selected Sites  
Choose one of the following options for displaying data for the sites meeting the criteria above

- Parameter Group Period of Record table
- Inventory of water-quality data (For printing)
- Tab-separated inventory of water-quality data (Save to file)
- Retrieve data from: [ ] to: [ ] (YYYY-MM-DD -- Blank = all data)
- Retrieve sample time and time zone:  as stored  in UTC
- Retrieve samples for specified parameter values: [ ] (Parameter Code) Greater than [ ] (Numeric Value)
- Samples and parameters to include:
  - Samples that include only above parameter selection criteria (Count: 0)
  - Samples that include above selection criteria and all associated parameters
  - Samples that include above selection criteria plus one or more of these parameters (Limit: 200 codes)
- Samples that include above selection criteria plus one or more of these parameters in a file  
Enter the full pathname of a file containing parameter codes. (Limit: 200 codes)

- Table of data (Default attributes)
- Tab-separated data (One sample per row with remain codes combined with values) (Default attributes) (YYYY-MM-DD) (Save to file)

\* Save compressed files with a .gz file extension.

Questions about data? [Data Tips](#)  
 Feedback on this web site [Explanation of terms](#)  
 Automated retrievals [Subscribe for system changes](#)  
[Help](#) [News](#)

Figure B-5. Screenshot of the water quality data selection page.

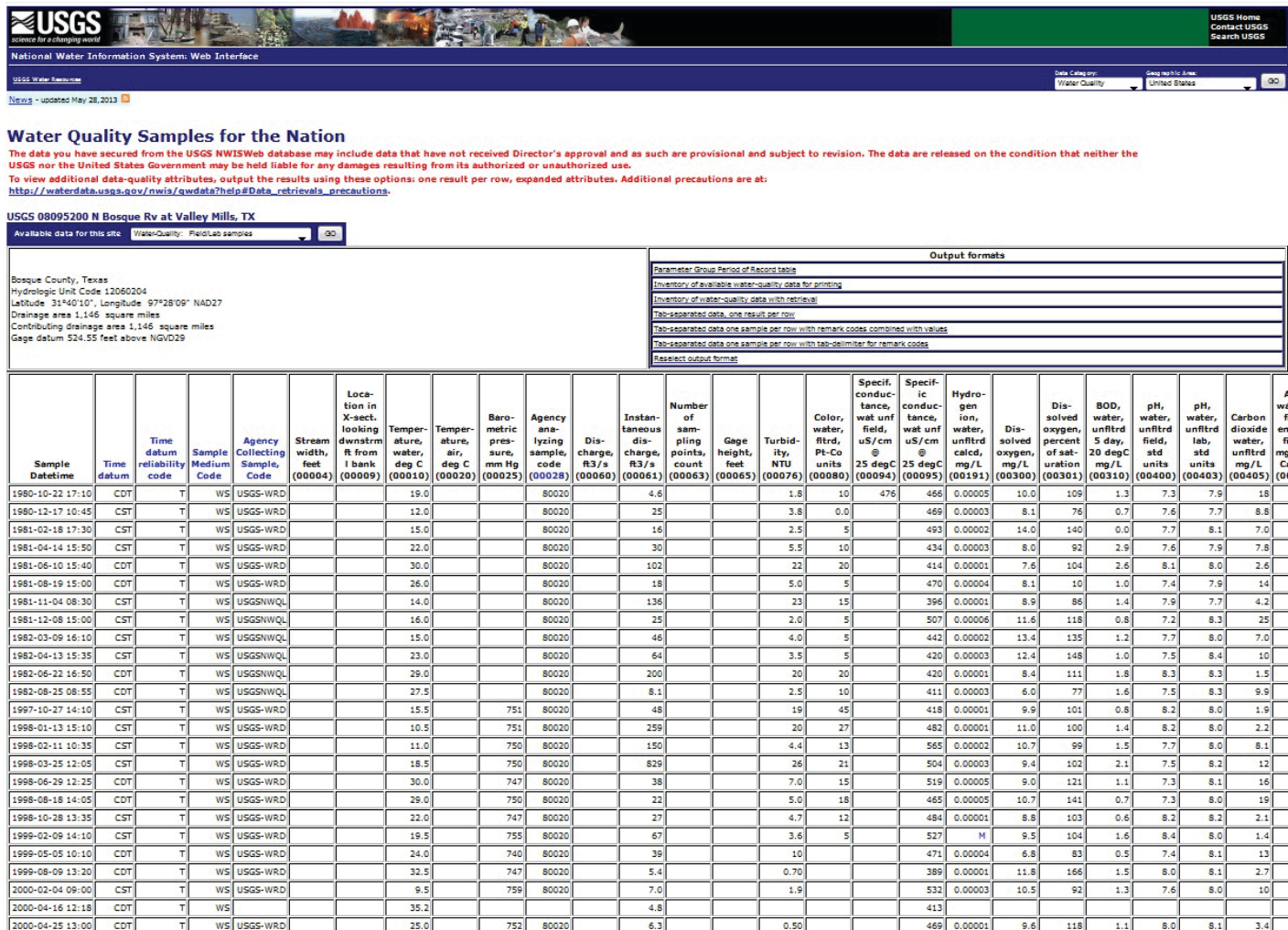

Figure B-6. Screenshot of "Parameter Group Period of Record Table".

The simplest, and most conservative, calculation is the relative dilution given by Equation (5), in which  $E = 0$  and  $K = 0$ . Equation (4) reduces to:

$$c(t) = \frac{c_a Q_a + c_s Q_s}{Q} \quad (7)$$

A runoff coefficient of 1 is used (because of the intense rainfall during a short period of time on the essentially impervious bridge deck). The storm runoff from the bridge deck  $Q_b$  is given by:

$$\begin{aligned} \text{Bridge deck runoff} &= \text{Rainfall coefficient} \times \text{rainfall rate} \times \text{bridge deck area} \\ &= 1 \times (0.2 \text{ ins/hr} \times 1/12 \text{ ft/in} \times 1/3600 \text{ hrs/sec}) \\ &\quad \times 20,000 \text{ ft}^2 \end{aligned}$$

$$\text{Bridge deck runoff} = 0.0926 \text{ cfs}$$

from which the bridge load is calculated by

$$\text{Bridge Load} = \text{Bridge deck runoff} \times \text{Concentration}$$

which is exactly the same equation as in Section 6.5.2, but the meanings and some of the values of the terms are different. As an example, nitrate load is computed. Using the same value of runoff concentration of 0.2 mg/L  $\text{NO}_3\text{-N}$  from Table B-2:

$$\text{Bridge nitrate load} = 0.926 \text{ cfs} \times 0.2 \text{ mg/L} \times 28.3 \text{ L/ft}^3$$

$$\text{Bridge nitrate load} = 5.2 \text{ mg/s}$$

The ambient flow is 10.1 cfs. For ambient concentration  $c_a$ , one option is the long-term mean concentration of 0.58 mg/L, see above. With these values,

$$\text{Upstream (ambient) nitrate load} = 10.1 \text{ cfs} \times 0.58 \text{ mg/L} \times 28.3 \text{ L/ft}^3$$

$$\text{Upstream nitrate load} = 165.8 \text{ mg/s}$$

**B-10**

If we assume that the only runoff from the storm originates from the bridge, i.e., we neglect  $Q_p$  and  $Q_d$  in (5), then (4) reduces to

$$\text{Downstream concentration} = (\text{Upstream load} + \text{bridge load}) / (\text{downstream flow})$$

$$\begin{aligned} \text{Downstream concentration} &= (165.8 + 5.2 \text{ mg/s}) / (10.1 + 0.093 \text{ cfs}) \times 0.0353 \text{ ft}^3/\text{L} \\ &= 0.59 \text{ mg/L} \end{aligned}$$

There is no stream standard for nitrate in Texas. The minimum detection limit for nitrate-nitrogen ranges 0.01–0.10 mg/L depending upon the methodology. Even with the conservative assumptions made, the effect of the bridge is at or below detection limits.

The above calculation makes several assumptions that magnify the effects of the bridge, which can be improved to arrive at a more accurate estimate. Foremost is the absurd assumption that rainfall only occurs on the bridge deck. In order to include these effects, it is necessary to estimate the rainfall rate on the stream itself  $Q_p$  and that falling on the adjacent drainage area  $Q_d$ , with the corresponding runoff concentrations. Assuming a circular storm of area  $20 \text{ km}^2 = 215.3 \times 10^6 \text{ ft}^2$ , its diameter is  $5.05 \text{ km} = 16560 \text{ ft}$ , which, if centered on the stream, is the length of stream covered by the storm. The nominal stream width is about  $50 \text{ ft} = 0.0153 \text{ km}$ , giving a surface area of  $0.0773 \text{ km}^2 = 828,000 \text{ ft}^2$ . Thus

$$\begin{aligned} \text{Drainage area affected by storm} &= (215.2782 \times 10^6 - 0.8278 \times 10^6 - 0.0200 \times 10^6) \\ &= 214.4304 \times 10^6 \text{ ft}^2 \end{aligned}$$

$$\text{Drainage area affected by storm} = 214.4304 \times 10^6 \text{ ft}^2$$

With a runoff coefficient for the rural drainage area of 0.3, the flow equivalents of rainfall become:

$$\begin{aligned} \text{Runoff from drainage area} &= \text{runoff coefficient} \times \text{rainfall rate} \\ &\quad \times \text{drainage area} \end{aligned}$$

$$\begin{aligned} \text{Runoff from drainage area} &= 0.3 \times \left( \begin{array}{l} 0.2 \text{ ins/hr} \times 1/12 \text{ ft/in.} \\ \times 1/3600 \text{ hrs/sec} \end{array} \right) \\ &\quad \times 214.4304 \times 10^6 \text{ ft}^2 \end{aligned}$$

$$\text{Runoff from drainage area} = 297.820 \text{ cfs}$$

$$\begin{aligned} \text{Rainfall on stream surface} &= \text{runoff coefficient} \times \text{rainfall rate} \\ &\quad \times \text{stream surface area} \end{aligned}$$

$$\begin{aligned} \text{Rainfall on stream surface} &= (1.0) \times \left( \begin{array}{l} 0.2 \text{ ins/hr} \times 1/12 \text{ ft/in.} \\ \times 1/3600 \text{ hrs/sec} \end{array} \right) \\ &\quad \times 82779 \text{ ft}^2 \end{aligned}$$

$$\text{Rainfall on stream surface} = 0.3832 \text{ cfs}$$

and from above

$$\text{Bridge deck runoff} = 0.0926 \text{ cfs}$$

The dilution factor  $D$  then becomes

$$\begin{aligned} \text{Dilution} &= \left( \begin{array}{l} \text{Ambient flow} + \text{runoff} \\ \text{from drainage area} + \text{rainfall} \\ \text{on stream} + \text{runoff from bridge} \end{array} \right) / (\text{runoff from bridge}) \end{aligned}$$

$$\begin{aligned} \text{Dilution} &= (10.1 + 297.82 + 0.383 + 0.0926 \text{ cfs}) / (0.0926 \text{ cfs}) \\ &= 3330 \end{aligned}$$

With much more work, reasonable estimates of the nitrate concentration in rainfall  $c_p$  and in runoff from the adjacent drainage  $c_d$  could be computed and used along with that of ambient  $c_a$  to estimate the resulting downstream concentration. A simpler, equally effective calculation is the increase in concentration due to the bridge runoff given by:

$$\begin{aligned} \text{increased concentration} &= \left( \begin{array}{l} \text{bridge runoff concentration} \\ - \text{downstream concentration that} \\ \text{would occur without bridge} \end{array} \right) / \text{dilution} \end{aligned}$$

The worst-case assumption is that the difference in the numerator is exactly the concentration from Table B-2, i.e., that there is no liability assigned (or no credit taken) for whatever nitrate concentrations are already present in the watercourse due to the storm, whereupon

$$\text{increased concentration} = (0.2 \text{ mg/L}) / 3330 = 0.00006 \text{ mg/L}$$

which is far below the minimum detection limits for this parameter.

A similar procedure can be followed for total copper. The same flow and dilution values apply.

$$\text{Bridge total copper load} = 0.926 \text{ cfs} \times 9.3 \mu\text{g/L} \times 28.3 \text{ L/ft}^3$$

$$\text{Bridge total copper load} = 243.7 \mu\text{g/s}$$

The ambient concentration at this station according to the above USGS website is low, frequently below detection limits, and averaging about  $2 \mu\text{g/L}$  when detectable. Then

$$\begin{aligned} \text{Upstream (ambient) total copper load} &= 10.1 \text{ cfs} \times 2 \mu\text{g/L} \\ &\quad \times 28.3 \text{ L/ft}^3 \end{aligned}$$

$$\text{Upstream total copper load} = 573 \mu\text{g/s}$$



If we *assume* that the only runoff from the storm originates from the bridge, i.e., we neglect  $Q_p$  and  $Q_d$  in (5), then (4) reduces to

$$\begin{aligned} \text{Downstream concentration} \\ = (\text{Upstream load} + \text{bridge load}) / (\text{downstream flow}) \end{aligned}$$

$$\begin{aligned} \text{Downstream concentration} \\ = (573 + 244 \mu\text{g/s}) / (10.1 + 0.093 \text{ cfs}) \times 0.0353 \text{ ft}^3/\text{L} \\ = 2.83 \mu\text{g/L} \end{aligned}$$

In this case, there is a state stream standard for total copper, which for average hardness 160 mg/L as CaCO<sub>3</sub>, is 22 μg/L. The calculated concentration of 2.8 μg/L is well below this concentration.

As noted above, this assumes that rainfall from the storm falls only on the bridge deck. If the other storm inflows to the stream are included, then, using (6) with zero concentrations in rainfall and land-surface runoff

$$\begin{aligned} \text{Upstream concentration} \\ = \left( \frac{\text{Ambient concentration}}{\times \text{ambient flow}} \right) / \left( \frac{\text{Ambient flow} + \text{runoff}}{\text{from drainage area}} \right. \\ \left. + \text{rainfall on stream} \right) \end{aligned}$$

$$\begin{aligned} \text{Upstream concentration} \\ = (2 \mu\text{g/L} \times 10.1 \text{ cfs}) / (10.1 \text{ cfs} + 297.820 \text{ cfs} + 0.3832 \text{ cfs}) \\ = 0.065 \mu\text{g/L} \end{aligned}$$

$$\begin{aligned} \text{Downstream concentration} \\ = \text{upstream concentration} \times (1 - 1/\text{dilution}) \\ + \text{bridge runoff concentration}/\text{dilution} \end{aligned}$$

$$\begin{aligned} \text{Downstream concentration} \\ = 0.065(1 - 1/3330) + 9.3/3330 \\ = 0.068 \mu\text{g/L}, \text{ well below the stream standard.} \end{aligned}$$

### Worked Example Problem

The bridge selected for the worked example is the new bridge on FM 56 over the North Bosque River, just west of Waco, Texas. A picture of the bridge is provided in Figure B-7. Segments of the North Bosque River are suffering from eutrophication resulting from high nutrient concentrations; consequently, nitrate and dissolved phosphorus have been selected as the constituents of interest. The primary sources are agriculture and dairy cattle. For a conservative assessment, the entire length of the bridge over the floodplain will be considered contributing directly to the river, rather than just the very small section over water. The length of this portion of the bridge is about 500 feet and the width is 40 feet.



Figure B-7. Crossing of North Bosque River.

The example follows the steps described in Chapter 1 and summarized in Figure 1-1. Although most of the emphasis in this example falls within Step 5, the steps are:

- Step 1. Development of project environmental documentation
- Step 2. Consideration of source controls and O&M BMPs
- Step 3. Determine if bridge is subject to NPDES permit
- Step 4. Determine NPDES permit treatment requirements
- Step 5. Determine if bridge is subject to 404 permit and 401 certification

### Step 1: Development of Project Environmental Documentation

This particular segment of the North Bosque is not listed for any pollutants, but other segments are listed for concerns related to organic matter. Therefore, this analysis will focus on the nutrients nitrate and dissolved phosphorus. During the development of the project environmental documentation it was determined that a 404 permit and 401 certification are required for the replacement project. In addition, the construction contractor is required to take measures to prevent harm to active swallow nests on the existing bridge. The Bosque River eventually drains into Lake Waco.

### Step 2: Consideration of Source Controls and O&M BMPs

Several source controls and operations and maintenance BMPs for consideration for all bridges are described in Chapter 4 of this guide. These can be low cost and effective means



of protecting water quality and are briefly considered here for this example.

- Collection and conveyance. Preventing the direct discharge of stormwater from the bridge deck to the receiving water by collecting and conveying it in pipes or on the deck to treatment facilities on land may be considered. For this bridge, this option will be evaluated in conjunction with the treatment BMPs in Step 5.
- Bird and bat roosting. Roosting birds and bats contribute organic material directly to receiving waters below. Since swallow roosting occurs on the existing bridge, it is reasonable to assume swallows will return to the new bridge unless mitigation measures are applied. Forms of netting, projections, and panels, as described in Section 4.2 of this guide should be considered for the new bridge.
- Bridge construction materials. Bridge decking and metal finishing materials should be evaluated for potential deposition during construction and maintenance activities.
- Bridge maintenance. Maintenance activities, e.g., painting materials and methods, bridge washing, winter maintenance, and sweeping, may reduce pollutant introduction to receiving waters. Long-term requirements for painting and bridge washing should consider this potential. Given the climate in this area, winter maintenance requirements will not be significant. Furthermore, given the rural nature of this bridge, sweeping is unlikely to be cost effective given the significant distance to travel to bring a sweeper to this location.
- Bridge inspection. In addition to inspection for structural integrity, regular bridge inspection may provide early identification of maintenance needs to mitigate peeling paint and other maintenance conditions affecting water quality.

**Step 3: Determine if Bridge is Subject to NPDES Permit**

This bridge is not subject to an NPDES permit since it is in a rural location. Skip Step 4 (Determine NPDES permit treatment requirements) and proceed to Step 5.

**Step 5: Determine if Bridge is Subject to 404 Permit and 401 Certification**

As mentioned previously, this bridge is subject to a 404 permit and 401 certification. Therefore, an assessment of water quality impacts must be completed (Step 5a).

**Step 5a: Perform Water Quality Assessment**

Earlier in this appendix, an analysis of the contribution of runoff to water quality was provided for this site. Using the *Simple Assessment* method, the conclusion is that the contribution of runoff from the bridge for nitrate and dissolved phosphorus are de minimis because the bridge loading is substantially less than one percent of the watershed loading as noted in the appendix. Using the *Complex Assessment* method a similar conclusion is made. In that analysis it is concluded that the effect of the bridge on nitrate and dissolved phosphorus concentrations is below detection limits and the nitrate and dissolved phosphorus concentrations are below the stream standard.

However, for the purposes of this example, it is assumed that the 401 certification requires the use of treatment BMPs to reduce annual loading of nitrate and dissolved phosphorus by at least 50%. This reduction is not meant to imply a local or broad standard, but is simply used as an example. Proceed to Step 5b to analyze the treatment options.

**Step 5b: Analyze Treatment Options**

This bridge runs approximately north south and is designed with a vertical curve resulting in drainage to both the north and south abutments. Direct discharge to the river is not allowed. Three hundred ninety-one feet of the total 580 ft span drain to the north, while the remaining 189 ft drain to the south. This analysis demonstrates the required techniques applied to the north side. The process would be similar for the south side.

For the north side drainage, a BMP may be sited north of the north abutment and on the west side of FM 56. It is anticipated that the BMP will not fit within the proposed right-of-way requiring the purchase of an additional easement.

The contributing area to the BMP includes the entire bridge deck, a portion of the approach roadway and a portion of the approach roadway embankment. For the approach roadway and approach roadway embankment, it is estimated that a 150 ft long section will drain to the BMP. Since only half of the approach roadway and embankment will drain to the west side, the widths for the roadway and embankment are both estimated at 22 ft. The total contributing area to the site is summarized in Table B-3 along with the applicable percent imperviousness. The percent imperviousness of 100 percent

**Table B-3. Contributing area characteristics.**

Contributing Area	Size (ft <sup>2</sup> )	Percent Imperviousness
Bridge deck	391 x 44 = 17,204	100
Roadway	150 x 22 = 3,300	100
Embankment	150 x 22 = 3,300	0
Total	23,804	86

is used for the bridge deck and roadway and zero percent is used for the embankment.

Tools for five BMP treatment options are provided with this guide and are considered here. However, listing in the guide should not limit the BMPs considered for a particular site. The listed BMPs are:

1. Bioretention
2. Dry Detention
3. Permeable Friction Course
4. Sand Filter
5. Swale

All five BMPs require common input data for the respective Tools. The *Project Location* tab provides for determination of rainfall characteristics. For this example, one clicks on the portion of the map that contains Texas for Step 1 and then selects *Texas* under the pull-down menu under Step 2. The applicable rain gage, (3) *North Central – Ft Worth Meacham*, is also selected for this site. Defaults for the remaining values are used for this example.

Several parameters are provided on the *Project Options* tab that affects the BMP costs. Table B-4 provides a summary of the primary parameters used for this example.

The *Project Design* tab includes data that may be common across multiple BMPs, as well as data that are unique to each BMP. In this example, the common data for the north portion of the bridge are the tributary area, the percent imperviousness, and the soil type grouping. The first two of these were previously noted as 23,804 ft<sup>2</sup> (0.546 acres) and 86% imperviousness. The soil type group is silt loam (Type B).

### Bioretention

The design parameters on the *Project Design* tab of the Bioretention Evaluation Tool are Storage Volume and the presence of an underdrain as is shown in Figure B-8. In order to achieve the required 50% reduction in the annual loading of nitrate and dissolved phosphorus, a storage volume of 1,000 ft<sup>3</sup> is needed leaving all other design inputs at their default values. Underdrains are not needed because the soil type is hydrologic Group B.

Fifty percent removal of the annual loading of nitrates and dissolved phosphorus is accomplished because this BMP captures and infiltrates 50% of the stormwater inflow. The

**Table B-4. Project options cost parameters.**

Parameter	Value
Location Adjustment Factor	100
Design Life	25 years
Discount Rate	5 percent
Inflation	3 percent
Expected Level of Maintenance	Medium

area required to site this BMP is at least 760 ft<sup>2</sup>, which represents the footprint of the BMP at the top of the freeboard level. Additional area will be needed for grading, access, and appurtenances.

Using the parameters summarized in Figure B-8 and the default components for bioretention, the total estimated capital cost of this BMP including design fees is \$15,400. Considering capital and maintenance costs, the net present value of the whole life cycle costs is \$61,000. Table B-5 summarizes the result of the analysis for the bioretention treatment BMP.

### Dry Detention

The design parameters on the *Project Design* tab of the Dry Detention Evaluation Tool are Storage Volume, the presence of an impermeable liner, and water quality depth as is shown in Figure B-9. In order to achieve the required 50% reduction in the annual loading of both nitrate and dissolved phosphorus, a storage volume of 1,500 ft<sup>3</sup> is needed while lowering the water quality depth to 1.1 ft to promote infiltration. An impermeable liner is not used so that infiltration may occur.

Fifty percent removal of the annual loading of dissolved phosphorus is achieved while 57% of the nitrates are removed. The area required to site this BMP is at least 2,180 ft<sup>2</sup>, which represents the footprint of the BMP at the top of the freeboard level. Additional area will be needed for grading, access, and appurtenances.

Using the parameters summarized in Figure B-9 and the default components for dry detention, the total estimated capital cost of this BMP including design fees is \$29,500. Considering capital and maintenance costs, the net present value cost over the whole lifecycle is \$59,000.

### PFC

The design parameters on the *Project Design* tab of the PFC Evaluation Tool are permeable friction course surface area and depth as is shown in Figure B-4. In order to achieve the required 50% reduction in the annual loading of both nitrate and dissolved phosphorus the entire bridge deck area of 17,204 ft<sup>2</sup> is used with a 3-inch course thickness.

According to the tool, PFC removes 66% of the dissolved phosphorus, exceeding the requirement, but none of the nitrates, falling short of the requirement of reducing both constituents by 50%. Because this BMP is applied on the bridge deck itself, no additional area is required for its implementation.

Using the parameters summarized in Figure B-10 and the default components for PFC, the total estimated capital cost of this BMP including design fees is \$24,500. Considering capital and maintenance costs, the net present value of the whole lifecycle cost is \$52,900.

Primary Bioretention Design Parameters	Value
Storage Volume (cu-ft)	1,000
Underlying Soil Design Infiltration Rate (in/hr)	0.3
Underdrain Present?	no
Ponding Depth (ft)	1

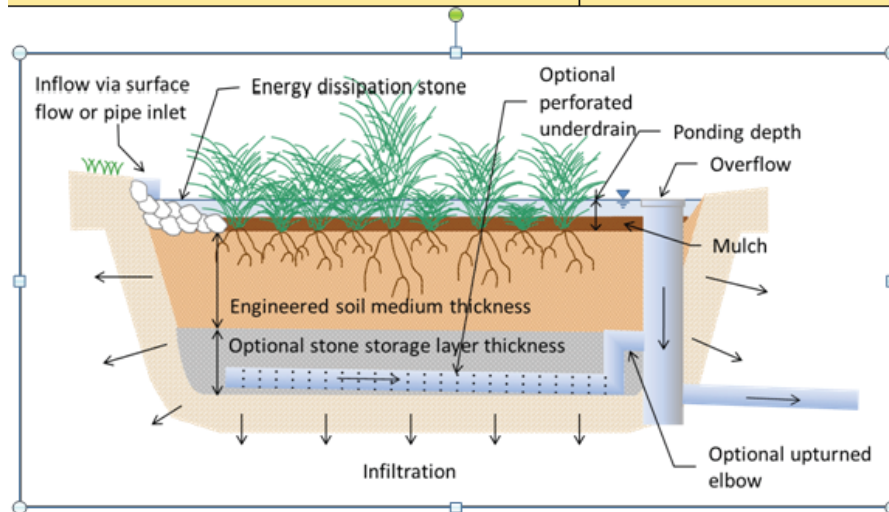

Figure B-8. Bioretention design parameter screen shot.

**Sand Filter**

The sand filter does not provide removals of nitrates or dissolved phosphorus according to the Sand Filter Tool. Therefore, this BMP is not applicable for this site.

**Swale**

The design parameters on the *Project Design* tab of the Swale Evaluation Tool are the swale bottom width, bottom length, and effective amended soil depth as is shown in Figure B-11. In order to achieve the required 50% reduction in the annual loading of both nitrate and dissolved phosphorus, a sufficient area for infiltration (swale bottom width multiplied by length) combined with an adequate amended soil

depth are needed. Conveyance capacity for storm flows and flow from other drainage areas must also be considered. In this case, it has been assumed that stormwater from other drainage areas will bypass in a separate conveyance. The resulting design parameters are shown in the figure.

Fifty percent removal of the annual loading of both nitrates and dissolved phosphorus are achieved with this design according to the tool. The area required to site this BMP is at least 1,260 ft<sup>2</sup>, which represents the footprint of the BMP at the swale bottom. Additional area will be needed for grading the side slopes, access, and appurtenances.

Using the parameters summarized in Figure B-11 and the default components for the swale, the costs were relatively high. One of the default components in this tool is a metal

Table B-5. BMP cost and performance comparison.

BMP	Capital Cost (\$)	Net Present Value (Whole Lifecycle) (\$)	Nitrate Removal (%)	Dissolved Phosphorus Removal (%)	Minimum Footprint (ft <sup>2</sup> )
Bioretention	\$15,400	\$61,000	50	50	760
Dry Detention	\$29,500	\$59,000	57	50	2,180
PFC	\$24,500	\$52,900	0	66	0
Sand Filter	not applicable	not applicable	0	0	not applicable
Swale	\$37,500	\$70,000	50	50	1,260

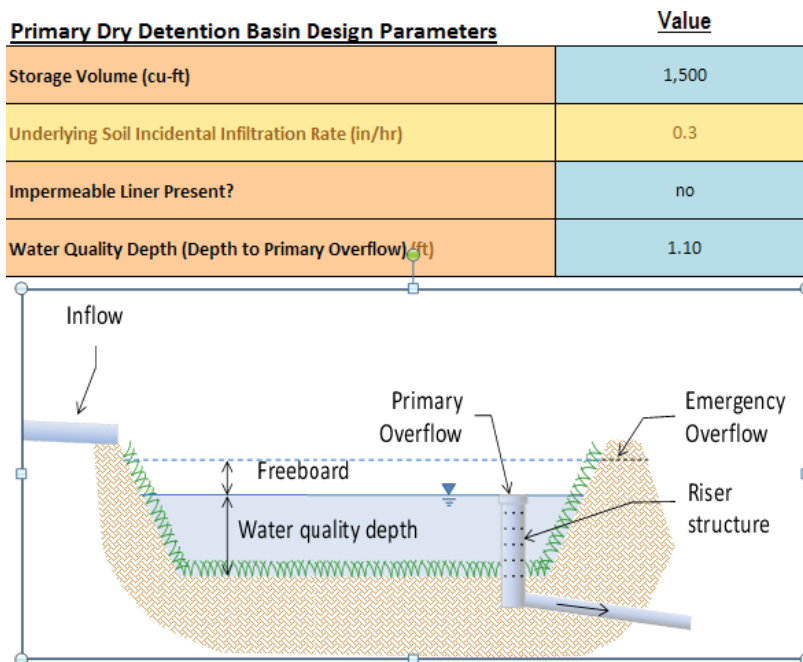

Figure B-9. Dry detention design parameter screen shot.

beam guardrail. This was removed from the costing because it would already be required for roadside safety with or without this BMP. In other words, it is not part of the cost required to achieve the pollutant removals. Without this component, the total estimated capital cost of this BMP including design fees is \$37,500. Considering capital and maintenance costs, the net present value of the whole lifecycle cost is \$70,000.

### Conveyance

An additional consideration for the implementation of each of the treatment BMPs, except for the PFC, is the potential need for collection and conveyance from the deck to the BMP. The cost for any such conveyance is added to the cost of the BMP for estimating the full cost of compliance.

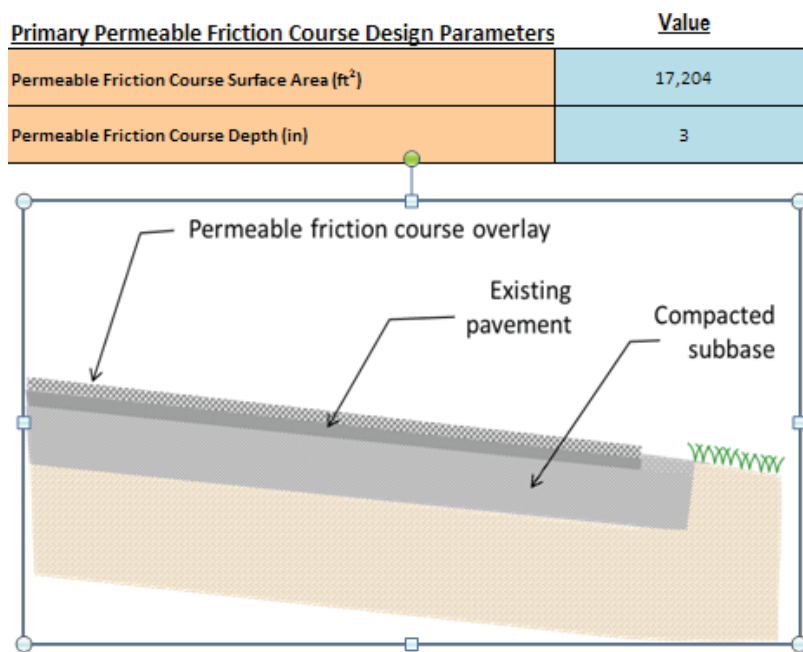

Figure B-10. PFC design parameter screen shot.



**Primary Swale Design Parameters**

Bottom Width (ft)	6
Bottom Length (ft)	210
Effective Amended Soil Depth (inches)	12
Underlying Soil Design Infiltration Rate (in/hr)	0.3

Swale Volume Reduction: 48%

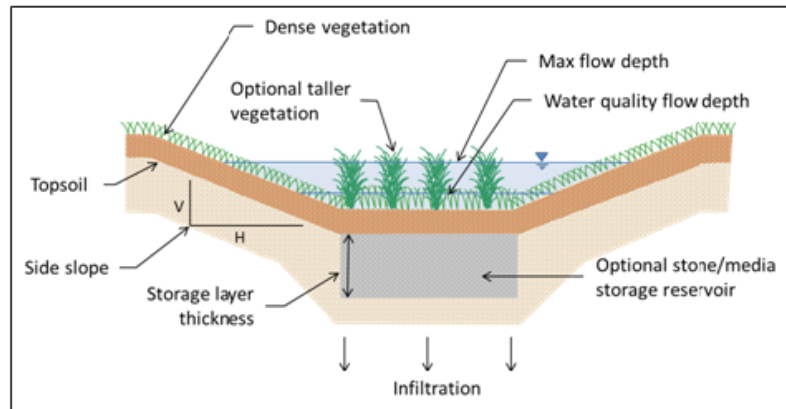

**Figure B-11. Swale design parameter screen shot.**

The Deck Drain Tool is used for this purpose. The parameters governing the design storm event and bridge configuration are entered into the Tool. The bridge deck length, width, longitudinal slope and transverse slope describe the drainage area. A runoff coefficient of 1.0 is used for the bridge deck and the design rainfall intensity is required for use in the Rational

Method. For this example, an intensity of 4.0 inches per hour is assumed. These inputs are shown in Figure B-12.

Using the Rational Method, the design flow (on each side of the deck) is:

$$Q = CCiA = 1.0(4.0)(391 \times 22/43,560) = 0.79 \text{ cfs}$$

**Bridge Stormwater Runoff - Cost Analysis (NCHRP 25-42)**

**MONOSLOPE BRIDGE GEOMETRY**

L = 391 ft Bridge Length  
 W = 44 ft Bridge Deck Width  
 S = 0.006 ft/ft Deck Longitudinal Slope  
 Sx = 0.020 ft/ft Bridge Deck Cross Slope  
 T = 10.00 ft Shoulder Width

**RAINFALL INTENSITY**

n = 0.016 Manning's roughness coefficient  
 i = 4.0 in/hr Rainfall intensity  
 C = 1 Runoff Coefficient= 1.0 for bridge decks  
 Ci = 4.0 in/hr

**INLET DIMENSIONS (1.38ft Wide x 1.38ft Long)**

Drain W = 1.375 ft Width of Inlet  
 Grate Bar = 0.188 ft Deck Drain Grate Thickness

Flow Capacity (Flowing Full) of Shoulder (T):  
 Qf = 1.844 cfs

Check Longitudinal Bypa:  
 dc = 0.200 ft D

**Figure B-12. Deck drain design parameter screen shot.**

Since this is less than the gutter capacity of 1.84 cfs calculated by the Tool and shown in Figure B-12, the design flow can be carried on the bridge deck within the 10 ft shoulder without any need of a collection and pipe conveyance system. If the shoulder width is reduced in the future as a result of changing the lane configuration, this must be reevaluated.

## Discussion

The final component of completing this analysis is to develop the most cost-effective strategy for meeting the water quality requirements. Of the BMP treatment alternatives summarized in Table B-5, PFC and the sand filter do not provide sufficient nitrate and/or dissolved phosphorus removals to satisfy the minimum requirements of 50% removals.

Of the remaining alternatives, bioretention offers the lowest capital cost and only slightly higher net present value whole lifecycle cost compared with dry detention. Although consideration of the lifecycle costs signals a slight cost advantage for dry detention, the operations and maintenance costs are uncertain compared to the capital cost. Given the pressure on roadway budgets, it may be difficult to justify doubling the upfront costs in the anticipation of small long-term savings.

In addition, bioretention has a smaller footprint than dry detention, reducing the easement acquisition requirements, which have not been included in the cost comparison. However, dry detention has the advantage of exceeding the standard for nitrate removal. The remaining alternative, the swale, is more expensive (capital and lifecycle) than bioretention and dry detention. Therefore, bioretention is the recommended treatment BMP for this example.

Another alternative that may be considered is treating runoff from an adjacent section of highway in the same watershed in lieu of treating the bridge deck stormwater runoff. This alternative would be an example of offsite treatment.

If this example had resulted in requiring a collection and conveyance system on the bridge, then treating a comparable highway section would eliminate the need for and cost of such a system. In addition, treating a comparable highway section would also eliminate the challenges of locating a treatment

BMP at or near a bridge abutment where the terrain may not be conducive to siting a BMP.

This example provided a sample analysis of the recommended assessment steps for the north section of the FM 56 bridge over the North Bosque River in Texas. The same procedure should be followed for the smaller south section to consider the full project. Overall the procedure must include consideration of the following:

- BMP costs and effectiveness
- The need for collection and conveyance on the bridge
- Comparison with treatment of an alternative roadway section

## References

- Bluestein, H. (2009). The Formation and Early Evolution of the Greensburg, Kansas, Tornado Supercell on 4 May 2007. *Weather and Forecasting*, 24: 899-920.
- Kane, R. C. (1987). Precipitation Characteristics of Mesoscale Convective Weather Systems. *J. Climate Appl. Meteor.*, 26: 1345-1357.
- Malina, J., et al. (2005). Characterization of Stormwater Runoff from a Bridge Deck and Approach Highway, Effects on Receiving Water Quality. Center for Transportation Research, University of Texas at Austin.
- Morin, E. D. (2006). Spatial Patterns in Thunderstorm Rainfall Events and Their Coupling with Watershed Hydrological Response. *Adv. Water Resources*, 29: 843-860.
- Owens MK, Lyons RK. (2004). *Evaporation and Interception Water Loss from Juniper Communities on the Edwards Aquifer Recharge Area*. Report to the Upper Guadalupe River Authority, Texas A&M University System.
- Pomeroy, Christine (2009). BMP and LID Whole Life Cost Models: Version 2.0, Water Environment Research Foundation Project SW2R08, Alexandria, VA.
- Smith, J. M. (2001). Extreme Rainfall and Flooding From Supercell Thunderstorms. *J. Hydromet.*, 2: 469-489.
- TRB (2004). *NCHRP Report 474: Assessing the impacts of bridge deck runoff contaminants in receiving waters, Vol. 2: Practitioner's Handbook*. Transportation Research Board of the National Academies, Washington, DC.
- URS Corporation (2010a). *Stormwater runoff from Bridges. Final Report to Joint Legislation Transportation Oversight Committee*, North Carolina Department of Transportation – Raleigh.
- URS Corporation (2010b). *Targeted Aggressive Street Sweeping Pilot Program: Phase III Median Sweeping Study*, prepared for the City of San Diego Stormwater Department, San Diego, CA.

## APPENDIX C

# Quick Start Guide

The purpose of this Quick Start Guide is to assist the experienced practitioner in developing information for regulatory agencies to document the likely impact of bridge runoff on a specific receiving water (Impact Assessment) and to determine the most cost effective BMP using the BMP Evaluation Tool if runoff treatment is required. Each of these elements is described below.

### Runoff Impact Assessment Strategy

Two general cases are presented for determining if treatment BMPs for bridge deck runoff are appropriate. The cases are differentiated according to the surrounding general land use, either rural or urbanized, which is consistent with the approach taken by USEPA for implementation of the NPDES permit program.

#### Rural Location

For the rural case, treatment of bridge deck runoff is generally not recommended since the impacts to the receiving stream are usually de minimis. This is an expected result since, as noted by *NCHRP Report 474*, “Highways typically constitute a very small fraction of a watershed’s total drainage area, and bridges often constitute a small portion of the highway drainage area. Thus, highways often, but not always, contribute a small fraction of the overall pollutant load to a given receiving water body, and bridges contribute even less.” In addition, studies evaluating water and sediment quality, as well as biological systems have failed to document environmental impact associated with bridge runoff.

Therefore, the default DOT position for rural bridges (defined as those outside of an NPDES Permitted area) is that no treatment BMPs are needed. It is only when a numeric analysis of impacts is required by the environmental document, or treatment BMPs are required pursuant to a resource agency permit, that an assessment of the impact of bridge

deck runoff on the quality of the receiving stream should be performed. The practitioner can provide evidence of the de minimis nature of the impact by performing either the *Simple* or *Complex Assessment*. The Simple Assessment calculates the percentage change in load in the water body resulting from discharge of bridge runoff. This assessment uses average annual values to make this determination. The Complex Assessment calculates the change in concentration for any constituent of concern based on a single, worst case event (historical low flow in the water body, resulting in the least possible dilution). These two procedures are described in detail in Chapter 3 and worked examples are provided in Appendix B.

Before performing either assessment, the DOT should consult with the regulatory agency to discuss the analysis approach. There may be areas of the country or specific receiving water requirements where treatment of bridge runoff will be required, regardless of the de minimis nature of the impact. In that case, the DOT should skip the assessment step and proceed directly to selecting the most cost effective BMPs for the constituents of concern from Chapter 4 (source control) and Chapter 5 (treatment control) using the BMP Evaluation Tool.

#### Urban Location

The primary factor affecting receiving water health in urbanized areas is the volume and quality of runoff from impervious surfaces in the watershed. The bridge itself is one of many small impervious parcels contributing runoff and, consequently, it is logical that it be subject to the same regulations as other impervious area. That is, the de minimis assessment does not apply because of the cumulative impact of many small impervious parcels. Since DOTs are subject to stormwater permit requirements in urban areas, the level of mitigation for bridge runoff should be guided by the DOT MS4 permit. If implementation of treatment BMPs for runoff from new impervious cover is considered necessary to comply with the maximum extent practical (MEP) reduction

in the discharge of pollutants as implemented in the applicable NPDES or other regulatory permit, then treatment BMPs should be implemented either at the bridge crossing itself or offsite (preferred for performance and cost reasons). Since the level of treatment required is specified in the stormwater permit, an assessment of water quality impacts is generally unnecessary in this case as well.

Figure C-1 provides an overview of the recommended analysis process for any bridge project crossing waters of the US.

*Step 1:* Development of the project environmental documentation will provide information related to the condition and status of the receiving water. Items that should be identified include whether the receiving water has site specific requirements such as a 303(d) listing or TMDL, whether it's included as an Outstanding National Resource Waters (ONRW), a domestic water supply reservoir, or has endangered species. These classifications will help determine the need for special consideration where the de minimis assessment is not allowable (due to the requirement for a zero increase in constituent load to the receiving water), and identify specific constituents of concern for performing either the Simple or Complex Assessment and selecting a BMP to achieve the desired discharge quality.

*Step 2:* All bridges should consider applicable source control and operation and maintenance BMPs; these are described in Chapter 4 of this guide. Source control BMPs include design and operational provisions to ensure that the bridge structure or traffic operations do not contribute pollutants to the receiving water during dry or wet weather to the extent practicable.

*Step 3:* Determine if the bridge is subject to an NPDES Permit. Bridges not subject to an NPDES Permit skip to Step 5, otherwise move to Step 4 to determine what BMPs are required by the DOT's MS4 Permit. The BMPs identified in Step 2 may meet NPDES Permit requirements; if this is the case, proceed to Step 5.

*Step 4:* Treatment requirements in the MS4 Permit, if any, should be incorporated into the project. If none are required beyond those already incorporated in Step 2, proceed to Step 5. If treatment is required by the DOT's NPDES Permit, proceed to Step 4a. The least cost and highest benefit can be achieved by treating a comparable section of terrestrial roadway (with similar AADT, adjacent land use and impervious area) rather than the bridge deck runoff. The tool described in Chapter 6 can be used to document the cost basis for treatment at an off-site location. The off-site treatment location should be within the same watershed or upstream of the bridge crossing. The recommended approach follows the basic tenants of MEP to select the location and BMP with the least cost and highest environmental benefit.

*Step 5:* Determine if a 404 Permit is required to construct or rehabilitate the bridge. Bridges that require a 404 permit

will also require the companion 401 water quality certification. The 401 Certification may contain requirements for treatment of deck runoff. The agency responsible for providing the 401 Certification should be consulted early in the project development process to determine if BMPs beyond those described in Chapter 4, or the DOTs MS4 Permit (for crossings in urban areas) will be included in the 401 Certification. If the resource agency is requiring BMPs beyond those in Chapter 4 or required as a part of the DOTs MS4 Permit, it is recommended that a simple or complex assessment be performed (*Step 5a*) to demonstrate that the bridge runoff will not have impacts on the receiving water.

## Treatment BMP Selection and Assessment

This Guide provides a BMP Evaluation Tool to assist the practitioner in documenting the benefit and cost analysis associated with treatment BMP implementation. The tool facilitates the computation of treatment BMP whole life cost and performance information as well as the whole life cost of a bridge deck drain collection system. This information can be quickly compared by the practitioner, for example, to an alternative land-based in-lieu treatment location to determine the treatment strategy with the least cost and highest benefit. The BMP Evaluation Tool is described in detail in Chapter 6 with a full user's guide presented in Appendix D.

The selection of the type of BMP for treatment of runoff either at the off-site in lieu location or at the bridge abutment is largely at the discretion of the designer. Several NCHRP publications can assist the designer in treatment BMP selection. Recent publications include, *NCHRP Report 565: Evaluation of Best Management Practices for Highway Runoff Control*, *NCHRP Report 728: Guidelines for Evaluating and Selecting Modifications to Existing Roadway Drainage Infrastructure to Improve Water Quality in Ultra-Urban Areas*, and NCHRP Project 25-20(01), "Evaluation of Best Management Practices and Low Impact Development for Highway Runoff Control." (published as NCHRP Report 565). Selection of the type of BMP will be driven largely by physical site constraints, since the BMPs described in these publications are targeted at constituents of concern for highways.

The tool accompanying this guide includes four treatment BMPs that are suitable for use at the abutment or on a convention highway section, and one that can be used on the bridge deck:

### At the abutment:

- Swales
- Dry Detention Basin
- Bioretention
- Media Filter



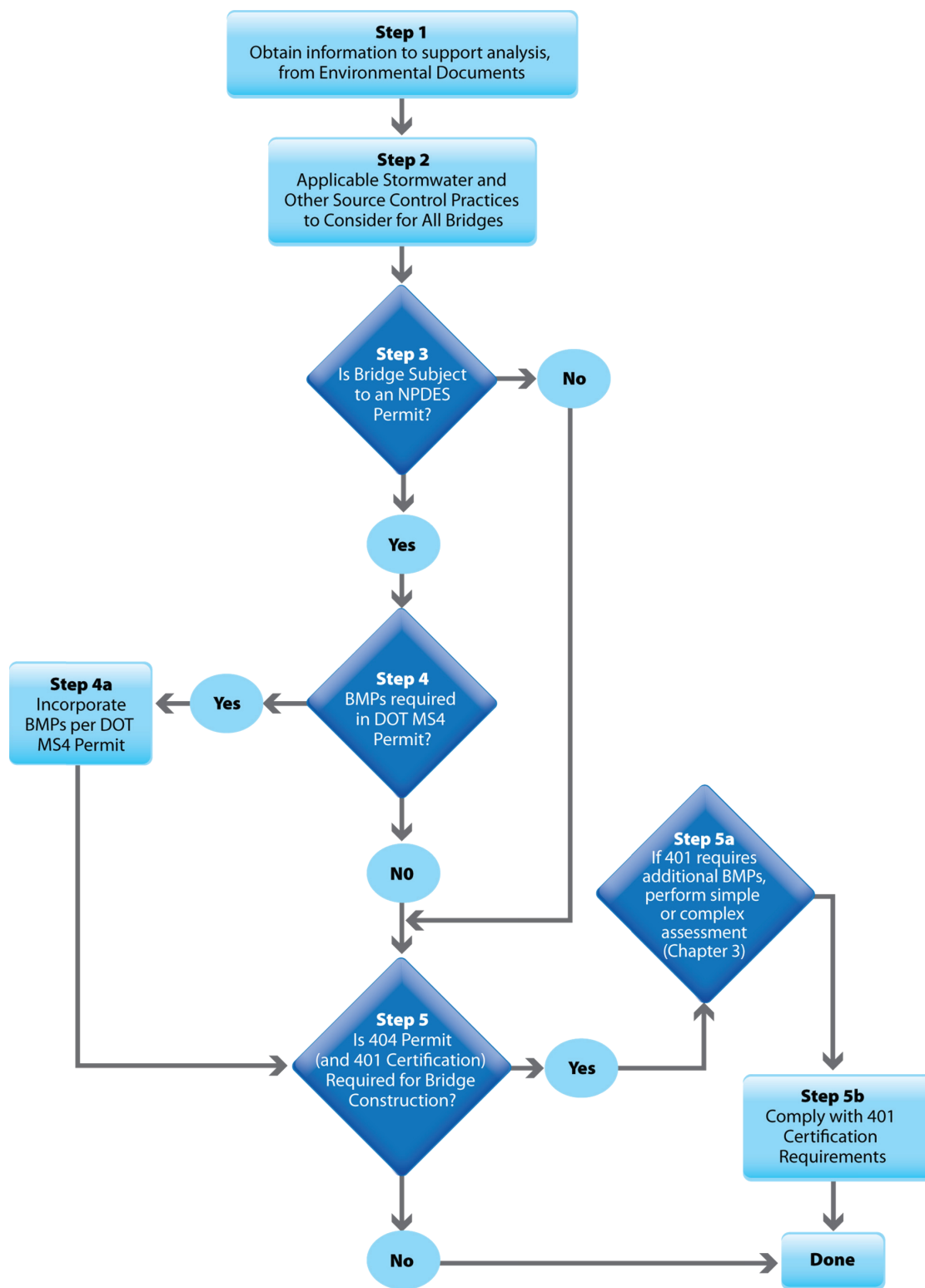

Figure C-1. BMP flowchart.

## C-4

**On the bridge deck:**

- PFC

These BMPs were selected for their performance, generally broad compatibility with highway physical site constraints, and familiarity to, and common use by DOTs. The practitioner is not constrained by these choices, and other BMPs may be a better fit for site conditions. A separate study, in process at the time this guide was prepared, “Long-Term Performance and Life-Cycle Costs of Stormwater Best Management Practices,” under NCHRP Program 25-40. This report provides an expanded list of BMPs for the practitioner to consider, as well as a tool similar to the one provided with this Guide to evaluate performance and whole life cost.

If treatment of runoff from the bridge deck is required, a PFC overlay could be considered to avoid the cost of a

bridge conveyance system. PFC is a thin lift of gap-graded asphalt, placed over a conventional hot mix asphalt section. The PFC layer has been demonstrated to improve water quality, as well as provide ancillary benefits such as reduced tire noise and improved visibility and stopping distance during rain events.

In all cases, treatment of an off-site at grade location is recommended in lieu of treating the actual deck runoff for bridges determined to require treatment. There are a variety of reasons why offsite mitigation of the impacts of bridge runoff on receiving water quality is preferred. These include the cost and technical feasibility of retrofitting existing or planned bridges, the fact that the majority of the contribution of pollutants from bridges actually occurs during dry weather, the lack of available space at the bridge landings, and the difficulty of providing routine maintenance for facilities installed on the bridge structure itself.

## APPENDIX D

# User's Guide for the BMP Evaluation Tool

### General Use of Tool

#### System Requirements

- The tool is intended to run in Microsoft Excel 2010 or 2013; macros must be enabled for the tool to run properly.
- The tool has been tested in a Windows 7 environment; user experience may differ in other operating system environments.
- Each instance of the tool requires approximately 10 MB of storage space.
- The tool involves no traditional “installation,” therefore should generally not require administrator privileges to use. For users operating within strict security settings, administrator privileges may be required to enable macros within Excel.

#### Downloading the Tool and Preparing for Use

To save the tool files on your computer, follow these steps:

1. Download the Zip file from the download location.
2. Save and extract the Zip file to any directory on your computer or server.
3. The tool consists of one single macro-enabled workbook (.xlsm) that is ready to use once extracted from the Zip folder. Another separate spreadsheet file that supports the tool is the deck drain cost tool (NCHRP\_deck drain cost.xlsx).
4. The original .xlsm tool file is read-only, therefore each instance of the tool must be saved as a new file name, as discussed in the following section.

#### Starting a New Project

To start a new project, follow these steps:

1. Open the original tool spreadsheet by double-clicking the .xlsm file extracted from the Zip Folder.
2. When the tool opens, it is necessary to enable macros. The process of enabling macros varies depending on local security settings in place. If macros are not enabled, the user should consult Excel support for guidance in enabling macros.
3. Save the project to a directory of the user's choice by using the “Save As” command in Excel. The file must be saved as a macro-enabled workbook (.xlsm) file.
4. The tool will open to the Project Location worksheet. The Header provides space to enter project information (Figure D-1).

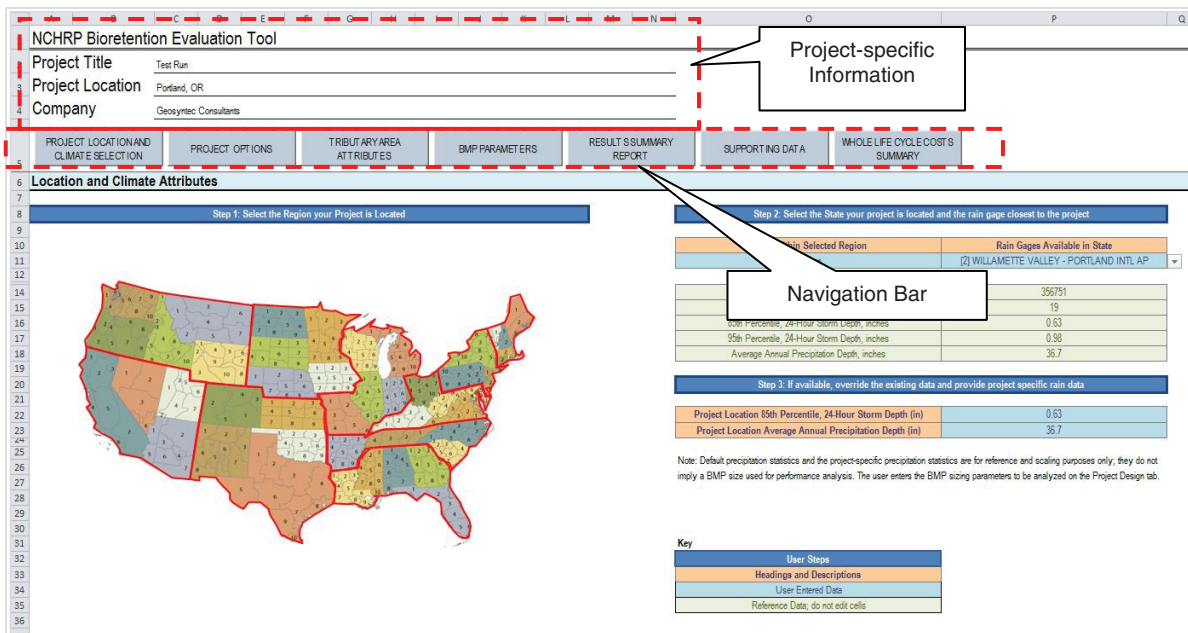

Figure D-1. Project information and navigation bar.

5. Once the project information is entered into the heading of the Project Location worksheet, the remaining headings on subsequent worksheets will be updated to match.
6. These steps can be followed for each project/scenario being analyzed with the tool.

### Organization of the Tool

The tool is divided into various input forms that reside on separate worksheets. In some cases, multiple input forms are found on a single worksheet. Primary worksheets have a gray tab color, the capital and maintenance cost worksheets have an orange tab color (hidden), and other miscellaneous tool supporting data have a blue tab color (hidden). Table D-1 summarizes the organization of the input forms and primary worksheets within the tool.

Table D-1. Organization of the tool.

Input Form	Worksheet Name	Summary of User Inputs and Results
Project Location and Climate Selection	Project Location	Specify project location View default climate parameters Override default climate parameters as needed
Project Options	Project Options	View/Edit Pollutant Concentrations Select Primary Cost Inputs
Capital Costs (Hidden)	Capital Costs	Optionally view capital costs sheet and override defaults
Maintenance Costs (Hidden)	Maintenance Costs	Optionally view maintenance costs sheet and override defaults
Tributary Area Attributes	Project Design	Specify tributary area characteristics View reference information related to precipitation and runoff volumes
BMP Design Parameters	Project Design	Specify BMP design parameters View and edit default and additional design parameters
Results Summary Report	Results Summary Report	View summary of performance results in tabular and graphical format
Supporting Data	Supporting Data	View underlying model results data used by the tool to provide performance estimates
Whole Life Costs Summary	Whole Life Costs Summary	View the whole life costs results in tabular and graphical format



Each input form contains stepwise instructions and a key to the color of cells that appear in the form. Color coding identifies cells as:

<b>User Steps</b>	Default data; editing allowed with rationale
User Entered Data	Guidance
Lookup Data; do not edit cells	Warnings

The user is expected to enter data for each “User Entered Data” cell at a minimum, and should review the default and reference values to verify that they are appropriate.

## Navigating within the Tool

The tool provides two options for navigation:

- The Navigation Bar that is located below the project information on every page (See Figure D-1) provides hyperlinks to jump to each input form. These buttons can be clicked to move forward or backwards to each input form.
- Traditional Excel navigation methods can also be used, including selecting worksheet tabs, scrolling, zooming, and other methods, as the user prefers.

Either of these methods can be used, interchangeably, at any point in use of the tool.

## Saving and Editing Scenarios

Each instance of the tool (i.e., each individual .xslm file) can only represent a single scenario. Multiple scenarios can be run using the following general steps:

1. Open a new instance of the tool
2. Enter inputs to define the first scenario
3. Save this scenario with a distinct file name (e.g., “File” → “Save As” → “ScenarioA1.xslm”)
4. Edit inputs to define a new scenario
5. Save this scenario with a distinct file name (e.g., “File” → “Save As” → “ScenarioA2.xslm”)
6. And so on for as many scenarios as desired. Files can be organized into directories to help distinguish different analysis scenarios. After scenarios are generated, any of the instances of the tool can be reopened by double-clicking on the selected .xslm file to view the scenario inputs and results.

## Printing Summary Results

Any sheet within the worksheet can be printed using native Excel print functions. The user can use Excel menus to specify the paper size, printer preferences, and print ranges. By selecting multiple worksheet tables, multiple worksheets can be printed at the same time. Please consult Excel documentation and help files for guidance on printing from Excel.

## Entering Project Location and Climate Information

### Selecting a Rain Gage

The first step in developing a project scenario is to select the appropriate precipitation gage for your project. A precipitation gage must be selected for values to appear in the Results Summary Report (Figure D-2):

1. Select your project’s region by clicking on the map.
2. Select your project’s state by using the drop-down menu under “States within Selected Region.”

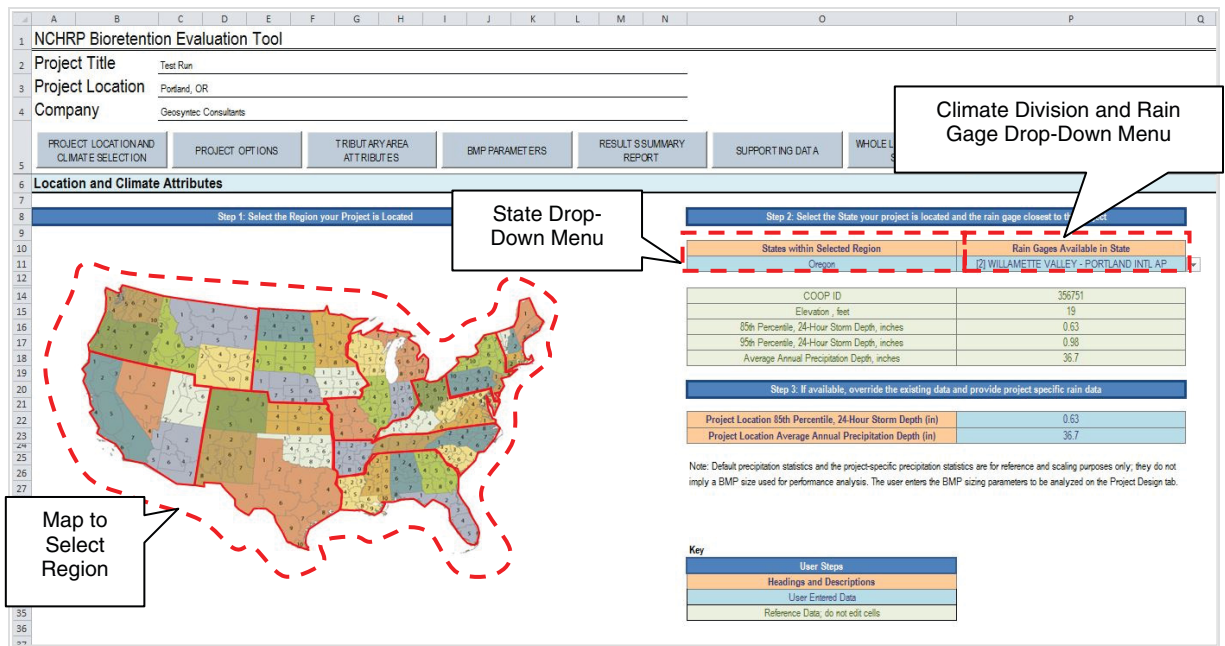

Figure D-2. Project location and climate selection layout.

3. Select the precipitation gage that best represents the project precipitation by using the drop-down menu under “Rain Gages Available in State.” Generally, the precipitation gage closest to the project location should be used. Each precipitation gage has associated evapotranspiration (ET) data as well.

### Providing Site-Specific Precipitation Statistics

When a gage is selected, the Tool provides a number of reference statistics related to the gage, including the 85th and 95th percentile, 24-hour storm depths and the average annual precipitation depth.

If localized precipitation statistics are available for the project location, these data can be used to improve the estimates provided by the tool. The tool uses the 85th percentile, 24-hour storm depth and the average annual precipitation depth to localize model estimates. To enter site-specific precipitation statistics, overwrite the “Project Location” values as called out in Figure D-3. If a new gage is selected, user-entered numbers will be overwritten and must be entered again if still applicable.

Note that default and project-specific precipitation statistics are for reference and scaling purposes only; they do not imply a BMP size used for performance analysis. The user enters the BMP sizing parameters to be analyzed on the Project Design Worksheet.

### Entering Project Options Information

To begin defining your project and determine the level of detail required, follow these steps to select the project options (Figure D-4):

1. Default highway runoff concentrations have been included to provide an estimate of pollutant load reduction. However, if project-specific runoff concentrations exist, then select “yes” after “Would you like to view/edit the highway runoff concentrations for the project?”
2. If “yes” is selected, the specific concentrations can then be updated by first changing the “Use Default” column to “no” and then entering your own concentration in the “influent

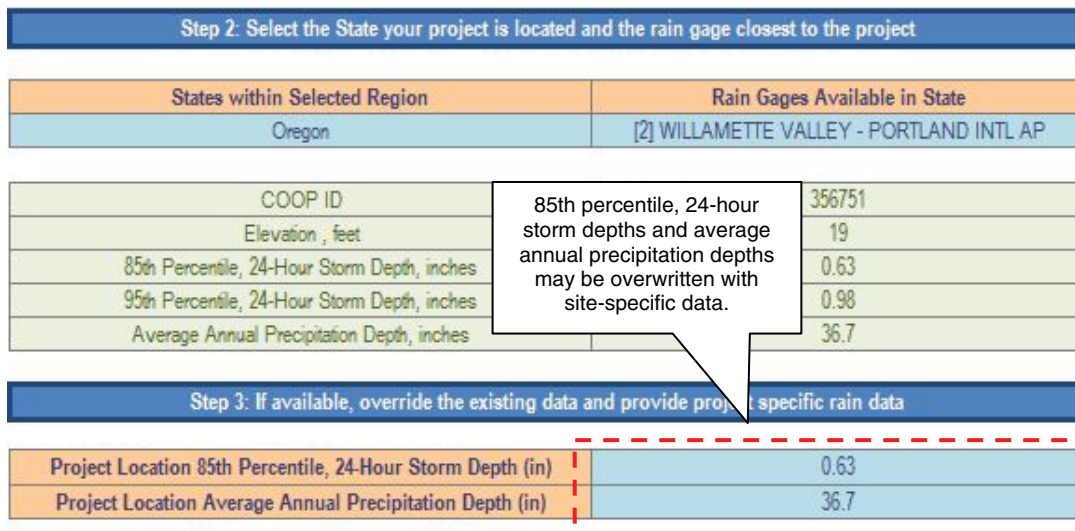

Note: Default precipitation statistics and the project-specific precipitation statistics are for reference and scaling purposes only; they do not imply a BMP size used for performance analysis. The user enters the BMP sizing parameters to be analyzed on the Project Design tab.

Figure D-3. Site-specific precipitation data.

concentration” column. Note that if you select “yes” to the default or “yes” to the question above about editing the defaults, the specific pollutant or all pollutant concentrations will be reset to the default concentration(s), respectively.

3. Enter the Cost inputs to provide site-specific results. The location adjustment factor should reference the RSMMeans location adjustment factor and the remaining inputs are specific to each project and location.
4. If you would like to keep the capital and maintenance costs as defaults, then select “no” in the “Would you like to view/edit the capital cost inputs?” and “Would you like to view/edit the maintenance cost inputs?” columns, respectively. However, you may choose to enter “yes” in either cell to edit the default values.

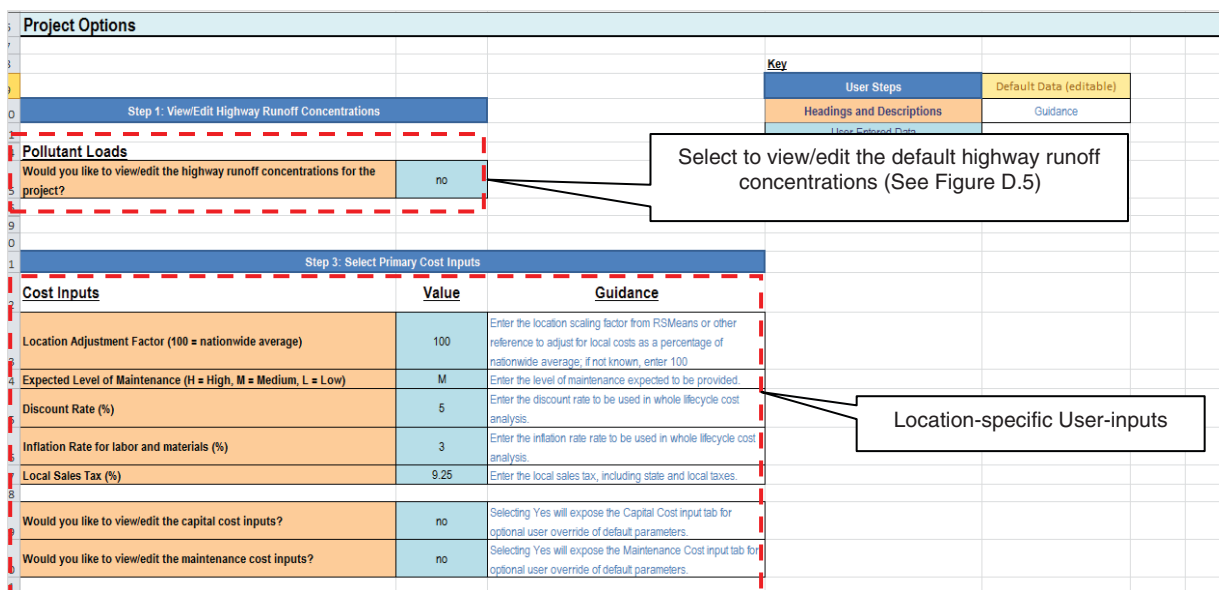

Figure D-4. Project options layout.

17	Pollutant of Concern	Use Default?	Influent Concentration	Guidance
18	Total Suspended Solids (mg/L)	yes	139	Provide influent concentrations known or select "yes" to use the default influent concentrations
19	Total Zinc (ug/L)	yes	190	
20	Total Lead (ug/L)	yes	44	
21	Total Copper (ug/L)	yes	41.8	
22	Total Nitrogen (mg/L)	yes	3.59	
23	Total Phosphorus (mg/L)	yes	0.44	
24	Nitrate [NO <sub>3</sub> ] (mg/L)	yes	1.06	
25	Total Kjeldahl Nitrogen [TKN] (mg/L)	yes	2.32	
26	Dissolved Phosphorus (mg/L)	yes	0.25	
27	Fecal Coliform (col/100mL)	yes	8,700	
28	Escherichia Coli [E. Coli] (col/100mL)	yes	6,025	

Figure D-5. Editing default highway runoff concentrations layout.

### Entering Capital and Maintenance Costs Information

If detailed capital and maintenance costs are available, selecting “yes” to the previous question about editing these costs will unhide two worksheets: “Capital Costs” and “Maintenance Costs.” If including the cost of a bridge deck conveyance system, the costs would be input under these tabs. Use the following steps to update the cost information:

1. In the “Capital Costs” worksheet, the default values are provided in green and the blue cells are provided for user input or override. If a user-input value is provided, the costs will reflect this value and if the user-input value is deleted, the cost will then return to the default cost. To reset all user-input capital cost values, click the button “Reset to Default values.” Note that all of the user-input values will be deleted.
2. In the “Maintenance Costs” worksheet, the default values are provided in the “Model” columns, which are based on your previous maintenance costs inputs. However, the blue cells are available to override these values with project-specific information. In the “Total cost per visit (\$)” column, the “user” column will calculate the total costs based on the selected user-input values as well as the unchanged default values. In the same column, the “Default total” will simply calculate the total cost based on all default values.

### Entering Project Design Information

#### Entering Tributary Area Attributes

To determine the quantity of runoff that will drain to the BMP in the design scenario, it is necessary to provide certain inputs regarding the tributary area watershed. Follow these steps to provide the necessary tributary area information (Figure D-6):

1. Enter the tributary area (in acres) that represents the entire area that will drain to your BMP. The tributary area should exclude the BMP area itself.
2. Enter the estimate of percent of the tributary area that is impervious (ranging from 0 to 100) which determines the relationship between impervious and pervious area and whether the rainfall will infiltrate or runoff.
3. Select a tributary area soil type from the drop-down menu provided. These soil types have been chosen to represent the typical hydrologic soil groups (A through D). The soil type selected here should be representative of the underlying soil beneath the tributary area. When this soil type is selected, a representative infiltration rate (based on the literature) is also copied into the “underlying soil infiltration rate” input for your BMP. However, note that the soil type may vary between the tributary area and the BMP area, and the infiltration rate should be updated to reflect a value that is appropriate within the BMP area. This may occur when different soils are present within the BMP area than the overall tributary area or when



PROJECT LOCATION AND CLIMATE SELECTION	PROJECT OPTIONS	TRIBUTARY AREA ATTRIBUTES	BMP PARAMETERS	RESULTS SUMMARY REPORT	SUPPORTING DATA	WHOLE LIFE CYCLE COSTS SUMMARY
<b>Tributary Area Attributes</b>						
Step 1: Provide data describing the tributary area of the project						
<b>Tributary Area Input Parameters</b>		<b>Value</b>	<b>Guidance</b>			
Tributary Area (acres)	1.5	Enter the total area tributary to the BMP including permeable pavement area, but excluding any BMP area outside of the roadway footprint.				
Impervious Area (%)	100	All impervious area is assumed to be directly connected within the BMP tributary area, adjust imperviousness to account for disconnection if present (Value entered as an integer (e.g. 80 for 80%).				
Tributary Area Soil Type (Hydrologic Soil Group)	Sandy Clay Loam (C)	Select the soil type that is most representative of the tributary area to the BMP.				
Calculated Runoff Coefficient	0.77	This runoff coefficient is calculated based on a Two-line regression model of the volumetric runoff coefficient (Fv) (Grenat, 2006).				
User-Provided Runoff Coefficient		Enter a site-specific runoff coefficient.				
<b>Tributary Area Runoff Reference Values</b>		<b>Value</b>	<b>Guidance</b>			
Reference 85th Percentile, 24-Hour Storm Depth, inches	0.63	Value is based on project-specific data.				
Reference Runoff from 85th Percentile Storm Event, cu-ft	2,540	Volume is based on project-specific data.				
Reference Average Annual Precipitation Depth, inches	36.7	Value is based on project-specific data.				
Reference Average Annual Runoff Volume, cu-ft	154,000	Volume is based on project-specific data.				

Tributary area watershed parameters to update

These cells are reference values that are calculated based on the user-entered tributary area parameters and the selected precipitation statistics

Figure D-6. Tributary area attributes layout.

better BMP area infiltration rate data are available, such as that obtained from field testing. It is strongly recommended that default infiltration rate values should be updated with site-specific information whenever available.

### Entering BMP Design Parameters

To begin providing the inputs for your BMP, follow these steps (Figure D-7):

1. The blue cells under the “Value” column are project-specific and should be updated. The yellow cells also may be project-specific; however, default values have been provided for these parameters. If the default parameters do not represent the project design, then they may be overwritten.
2. In addition to the primary design parameters, some BMPs will also have additional parameters that are shown below the BMP figure. Default parameters are provided for many inputs; however these should be changed to match actual project design configurations, when known, to provide the most accurate results.

Primary Bioretention Design Parameters	Value	Guidance	Default Values
Storage Volume (cu-ft)	1,500	Enter the total storage volume provided by the bioretention (including ponding, planting media, and stone reservoir storage).	User-entered
Underlying Soil Design Infiltration Rate (in/hr)	0.3	A default infiltration rate has been provided based on the soil type selected for the tributary. If a localized site infiltration rate is available, it should override this default data. If the system is lined with an impermeable barrier, enter zero.	By tributary soil type; recommend user override with site data
Underdrain Present?	yes	Underdrains should be considered if infiltration rates are not adequate to drain the system in a reasonable time. The elevation of the underdrain can be specified in the default parameters section.	A and B Soils: No C and D Soils: Yes
Ponding Depth (ft)	1	Ponding depth is equal to the elevation of the overflow above the surface of the planting media.	1

Additional Bioretention Design and Reference Parameters	Value	Guidance	Default Values
Planting Media Thickness (ft)	2	Thickness of engineered planting media (aka bioretention soil media), excluding mulch layer.	2
Stone Reservoir Thickness (ft)	1	Inclusive of choking stone layers if present. Note: Stone Reservoir Thickness must be greater than the Underdrain Thickness. Excludes from bottom of the stone reservoir.	1

User-entered primary design parameters

Guidance column to help the user select the appropriate inputs for their design

Additional design and reference parameters

Figure D-7. BMP design parameters input form layout.

Note: Guidance regarding the individual BMP parameters is not provided in this guide. Please refer to the “Guidance” and “Default Value” columns located within the Tool that provide guidance for each parameter specific to the BMP selected.

## Viewing and Interpreting Results

### Viewing Results

The “Results Summary Report” worksheet is updated based on the scenario that has been inputted in previous forms. It is designed to be printed on a single page to document key inputs as well as results. The Results Summary Report page consists of the following three sections:

1. A summary of your design;
2. A summary of the whole lifecycle cost results; and
3. A tabular and graphical summary of volume and pollutant load performance.

The first part of the sheet (Figure D-8) summary section provides a concise description of your BMP design and the key conceptual design parameters.

The whole life cycle costs results are summarized to include user-specified inputs such as “assumed level of maintenance” and then final results displaying estimated capital and maintenance costs and 50-year net present value costs. The volume and pollutant load performance results are broken down to display the volumes and loads associated with various treated and untreated flows through the BMP. These volumes and loads are also used to calculate estimated whole water concentrations for each constituent (Figure D-9).

### Whole Life Costs Summary

The whole life costs summary tab provides a more detailed look at the capital and maintenance costs associated with the project as displayed in Figure D-10. These detailed costs are broken down to analyze specific costs and they are summarized in graphical format. A further discussion on the development of whole life costs is provided in Appendix E.

### Viewing Supporting Data

The Supporting Data Worksheet provides selected plots showing the continuous simulation model results that are being referenced by the tool to provide the BMP-specific performance results as displayed in Figure D-11. The information on this worksheet is not editable, but is provided for informational and technical documentation purposes only.

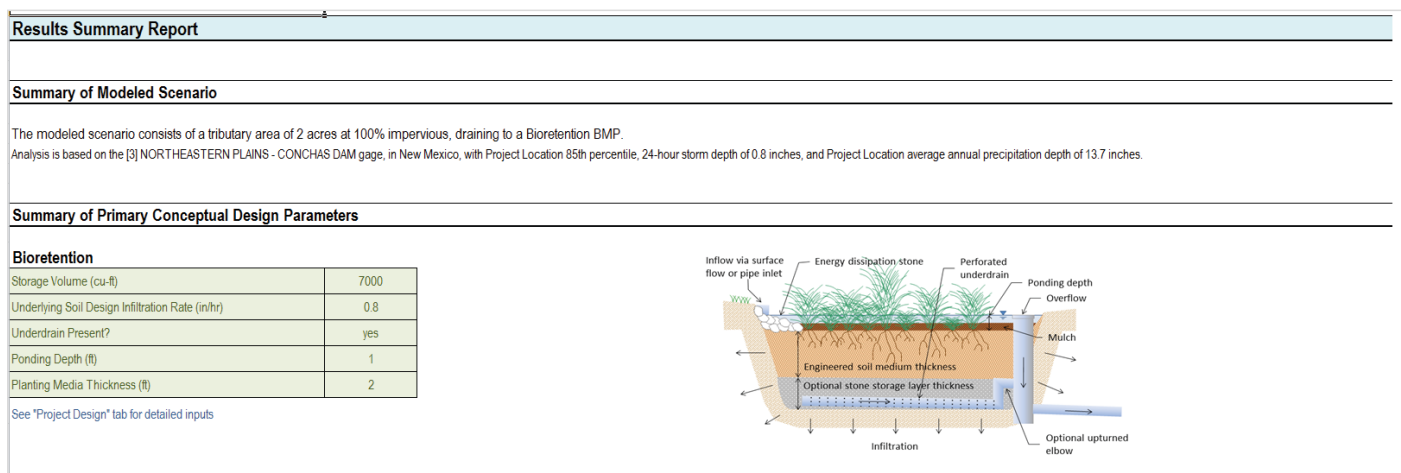

Figure D-8. Results summary report—echo of scenario inputs.

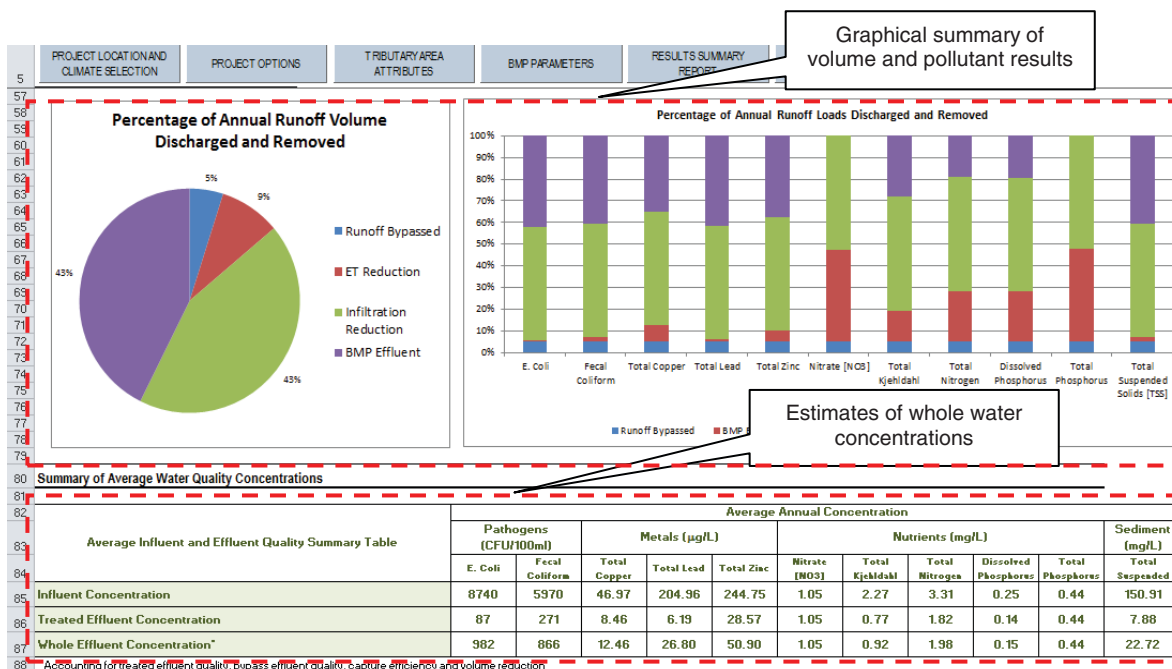

Figure D-9. Volume performance tabular and graphical results.

Whole Life Costs Summary			
<b>CAPITAL COSTS</b>		Total Cost	
Total Facility Base Cost		\$155,780	
Total Associated Capital Costs (e.g., Engineering, Land, etc.)		\$86,848	
Capital Costs		\$242,628	
<b>REGULAR MAINTENANCE ACTIVITIES</b>		Years between Events	Total Cost per Visit
Inspection, Reporting & Information Management		1	\$180
Vegetation Management with Trash & Minor Debris Removal		1	\$1,380
add additional activities if necessary		0	\$0
add additional activities if necessary		0	\$0
Totals, Regular Maintenance Activities			\$1,560
<b>CORRECTIVE AND INFREQUENT MAINTENANCE ACTIVITIES (Unplanned and/or &gt;3yrs. betw. events)</b>		Years between Events	Total Cost per Visit
Corrective Maintenance		8	\$6,740
add additional activities if necessary		0	\$0
add additional activities if necessary		0	\$0
Totals, Corrective & Infrequent Maintenance Activities			\$6,740
Capital Costing Method		Line Item Engineer's Estimate	
Assumed Level of Maintenance		M	
Estimated Capital Cost, \$ (2013)		\$242,628	
Estimated NPV of 50-year Maintenance Costs, \$ (2013)		\$74,052	
Estimated NPV of 50-year Whole Life Cycle Cost, \$ (2013)		\$316,680	
Estimated Annualized Whole Life Cycle Cost, \$/yr (2013)		\$6,334	
<small>Totals are based on assumed service life of 50 years with routine and major maintenance.</small>			

Figure D-10. Whole life costs summary tables.

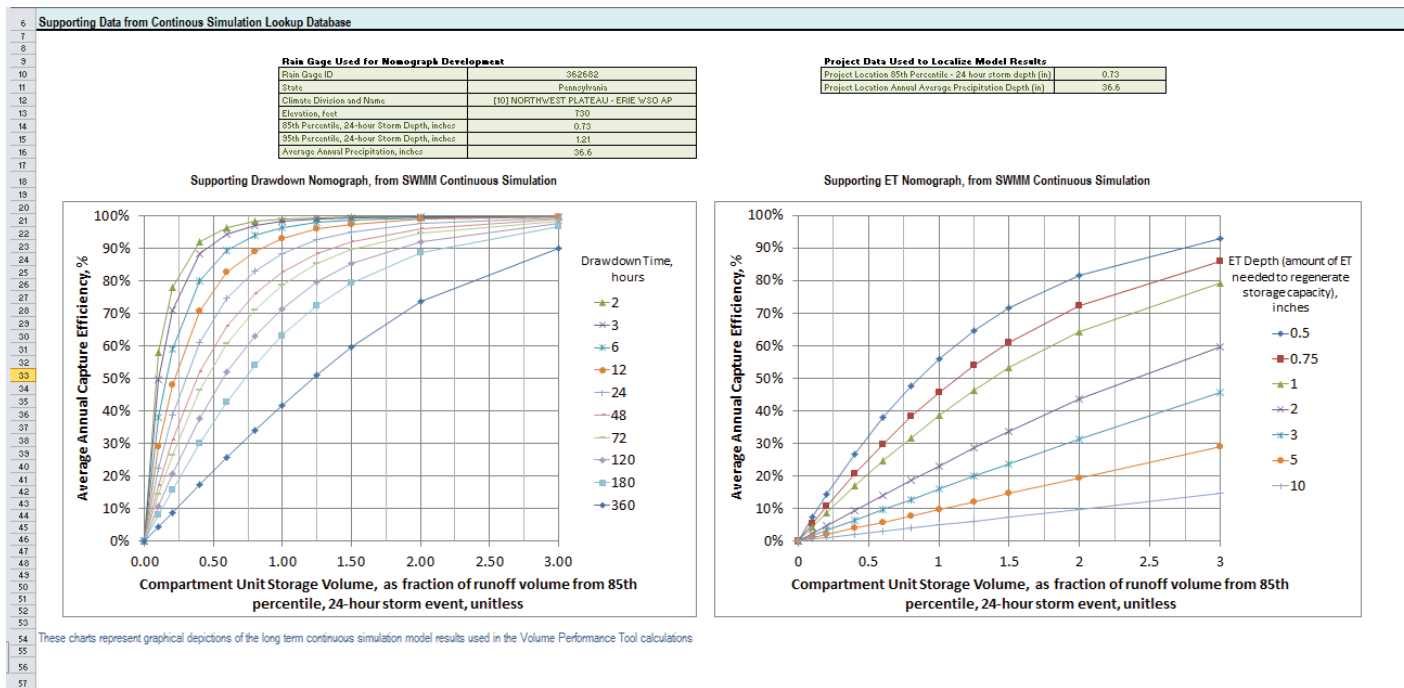

Figure D-11. Supporting data modeling results.

### Error Messages

This tool provides volume reduction estimates by referencing tens of thousands of hydrologic simulations. Because an individual simulation is not being run for each individual project, this tool has some inherent limitations. When providing inputs, the tool interprets them and returns values based on a specific range of data. If the user provided data is outside of this range, the tool will override the user-input with the minimum and maximum values, respectively. In the event that this occurs, the tool will likely be underestimating performance if forced to use the maximum value or overestimating performance if forced to use the minimum value. If the input bounds are exceeded and the minimum or maximum is used, an error message will be displayed for the applicable BMP, similar to that shown in Figure D-12. The user should review the error message and adjust inputs and/or interpret results accordingly.

### Tool Theoretical Basis and Technical Assumptions

This tool is based on a number of technical assumptions. These assumptions are not critical for general use of the tool, however may be relevant for interpreting results and understanding the limits of the applicability of the tool. For detailed information about the theoretical basis for the tool and the underlying technical assumptions, see the BMP Evaluation Tool Modeling Methodology (Appendix E) to the Bridge Stormwater Runoff Analysis and Treatment Options guide.

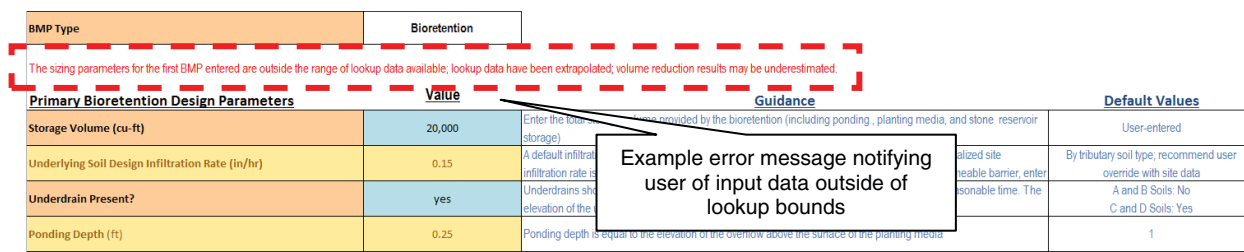

Figure D-12. Error message (shown in red).



## Bridge Deck Drain System Cost Support Tool

A separate spreadsheet is provided to aid the practitioner in computing the cost of the deck drain system, if one is needed to convey runoff to the bridge abutment. The capital cost for the conveyance system *is added* to the estimate computed by the BMP Evaluation Tool by clicking the Project Options tab to reveal the screen shown in Figure D-13:

The user should change the blue input field to “yes” for view/edit of the capital and maintenance cost inputs as desired. Note that this guide does not support development of maintenance cost estimates for deck drain conveyance systems. The practitioner should consult with their maintenance division for estimates of the cost of average annual maintenance for the system

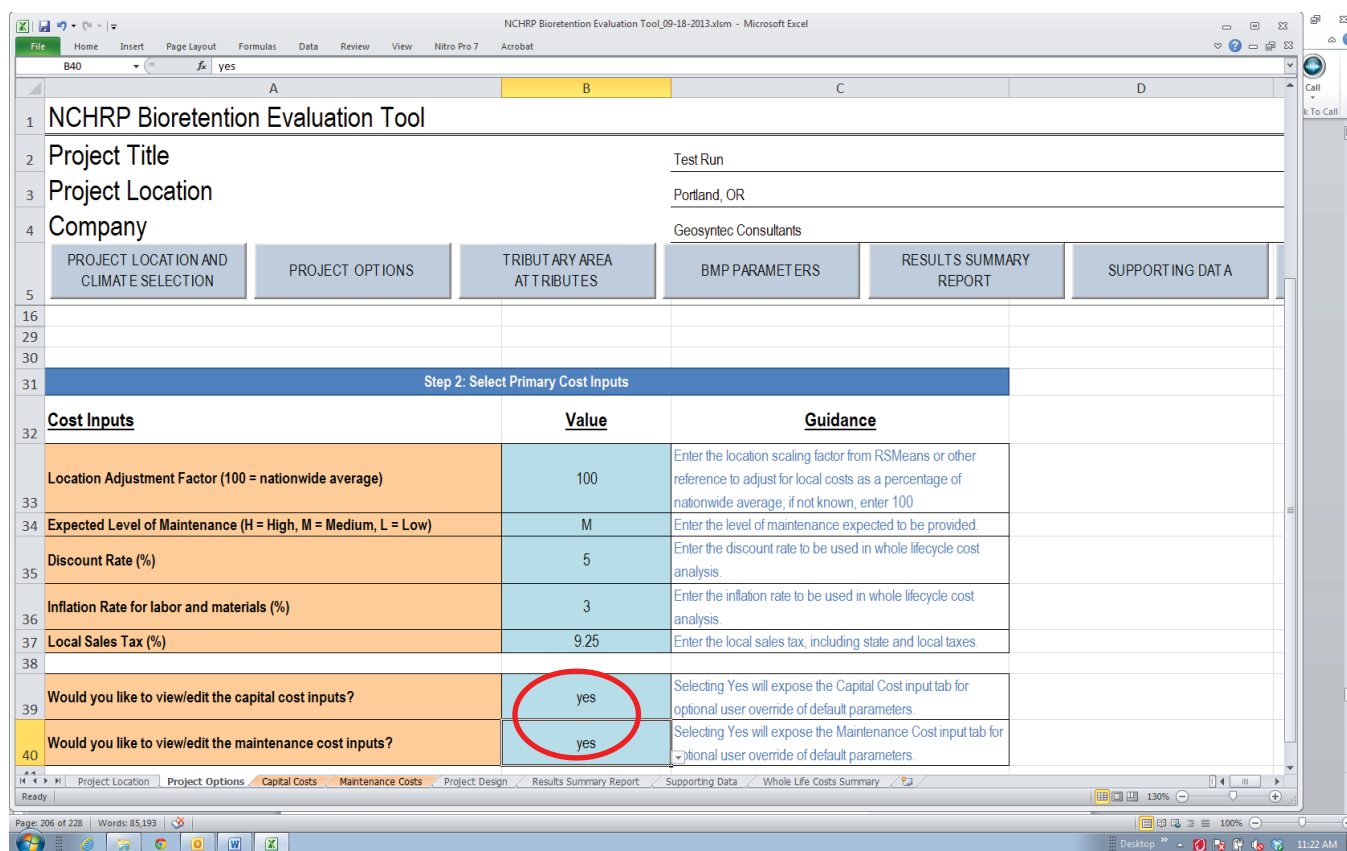

	PROJECT LOCATION AND CLIMATE SELECTION	PROJECT OPTIONS	TRIBUTARY AREA ATTRIBUTES	BMP PARAMETERS	RESULTS SUMMARY REPORT	SUPPORTING DATA	WHOLE LIFE CYCLE COSTS SUMMARY
31	<b>Step 2: Select Primary Cost Inputs</b>						
32	<b>Cost Inputs</b>		<b>Value</b>	<b>Guidance</b>			
33	Location Adjustment Factor (100 = nationwide average)		100	Enter the location scaling factor from RSMMeans or other reference to adjust for local costs as a percentage of nationwide average; if not known, enter 100			<a href="http://www.rsmeansonline.com/">http://www.rsmeansonline.com/</a>
34	Expected Level of Maintenance (H = High, M = Medium, L = Low)		M	Enter the level of maintenance expected to be provided.			
35	Design Life (years)		25	Enter the design life of the BMP in years.			
36	Discount Rate (%)		5	Enter the discount rate to be used in whole lifecycle cost analysis.			
37	Inflation Rate for labor and materials (%)		3	Enter the inflation rate to be used in whole lifecycle cost analysis.			
38	Local Sales Tax (%)		0	Enter the local sales tax, including state and local taxes.			
39							
40	Would you like to view/edit the capital cost inputs?		no	Selecting Yes will expose the Capital Cost input tab for optional user override of default parameters.			
41	Would you like to view/edit the maintenance cost inputs?		no	Selecting Yes will expose the Maintenance Cost input tab for optional user override of default parameters.			

Figure D-13. Project options.

being modeled. The detailed capital cost screen in the evaluation tool is shown in Figure D-14, and the field highlighted where the bridge deck conveyance system cost can be entered.

Similarly, the maintenance cost for the conveyance system can be entered under the Maintenance Cost tab as an ‘additional activity’ if desired as shown in Figure D-15.

The capital conveyance system cost can be estimated using the spreadsheet provided with this guide (NCHRP\_deck drain cost.xlsx). The spreadsheet computes the required deck drain configuration and capital cost given the bridge geometry. Hydraulics on the bridge deck are computed using Manning’s equation and hydraulics (pipe diameters) of the closed conduits are computed using continuity. Note that the spreadsheet computes the cost for the entire cross section of the bridge (each side of opposing traffic lane area), but only for a constant longitudinal grade. If the bridge includes a sag or crest vertical curve, two computations, one for each side of the high or low point respectively, must be completed. Figure D-16 shows a view of the input and output page of the bridge deck drainage system cost spreadsheet.

The input cells are noted by the red oval and shaded in blue. Inputs are:

- Bridge length
- Bridge width
- Longitudinal slope
- Cross slope
- Shoulder width
- Rainfall intensity

Input variables are defined in the graphic. Note that although a box-girder type cross section is shown, the tool is applicable for all types of bridges where a CIP drainage system and cast-iron inlets are used. The conveyance cost estimate tool will provide a preliminary cost for pumping

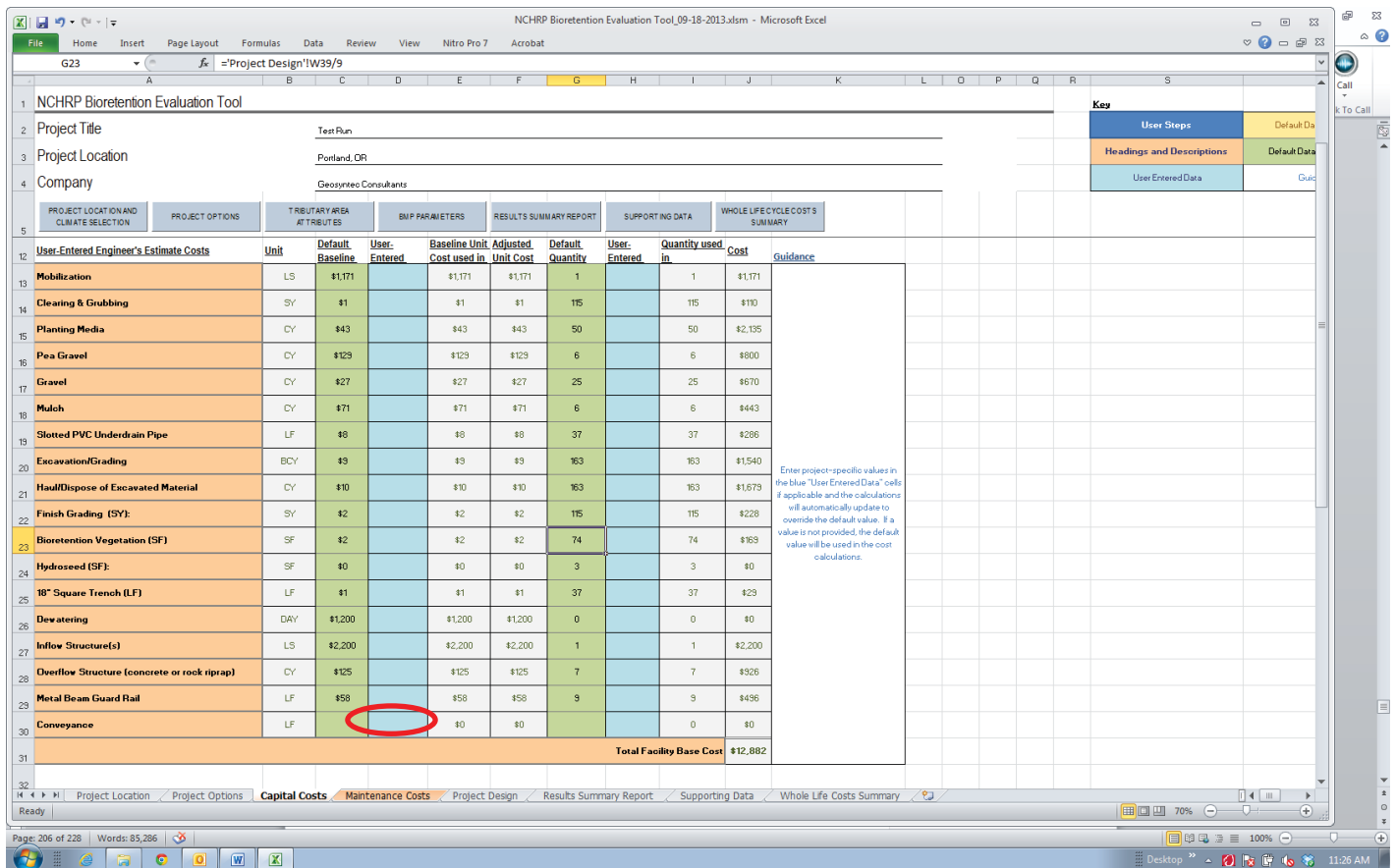

Figure D-14. Bridge deck drainage system cost input field.

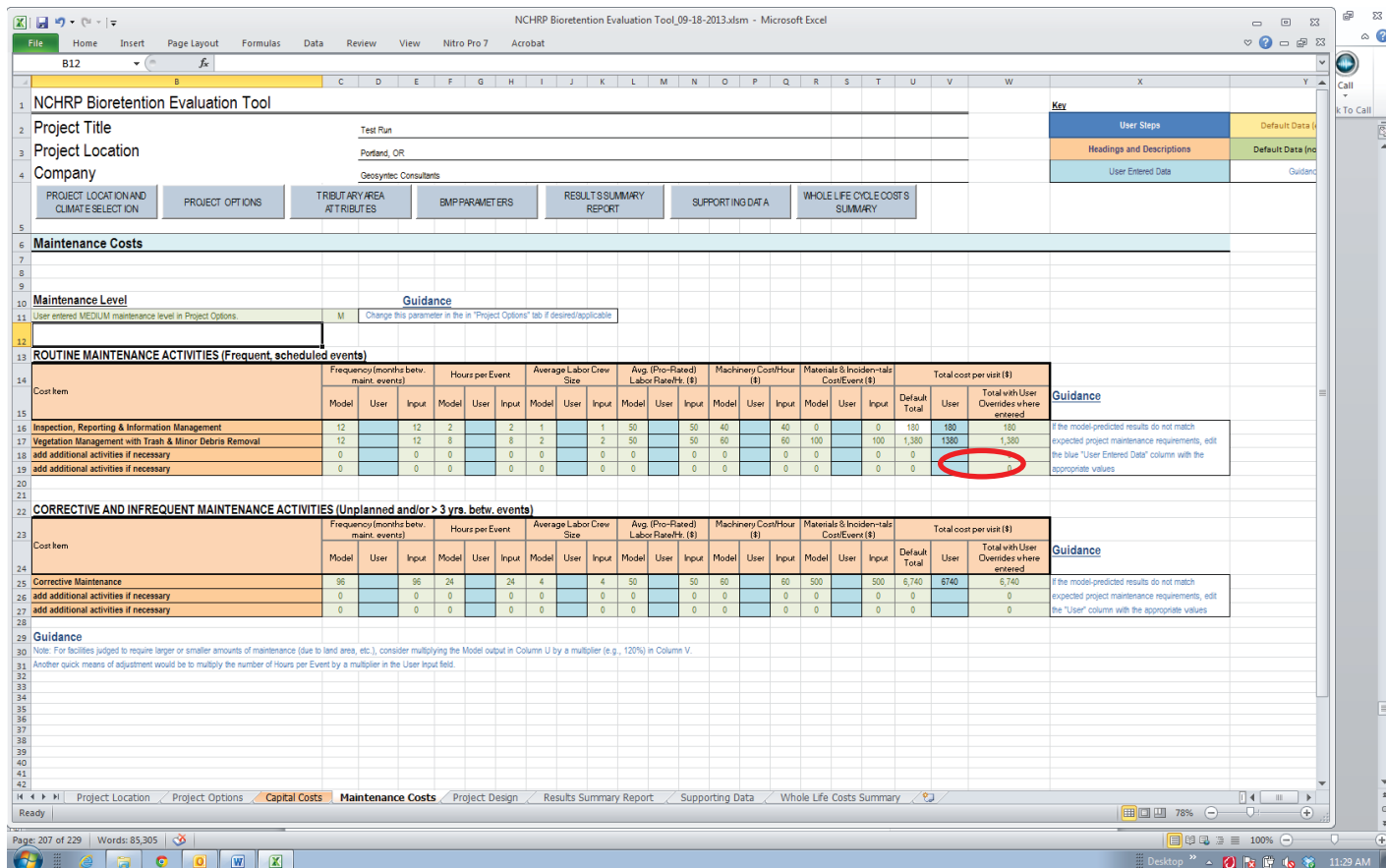

Figure D-15. Conveyance maintenance cost input field.

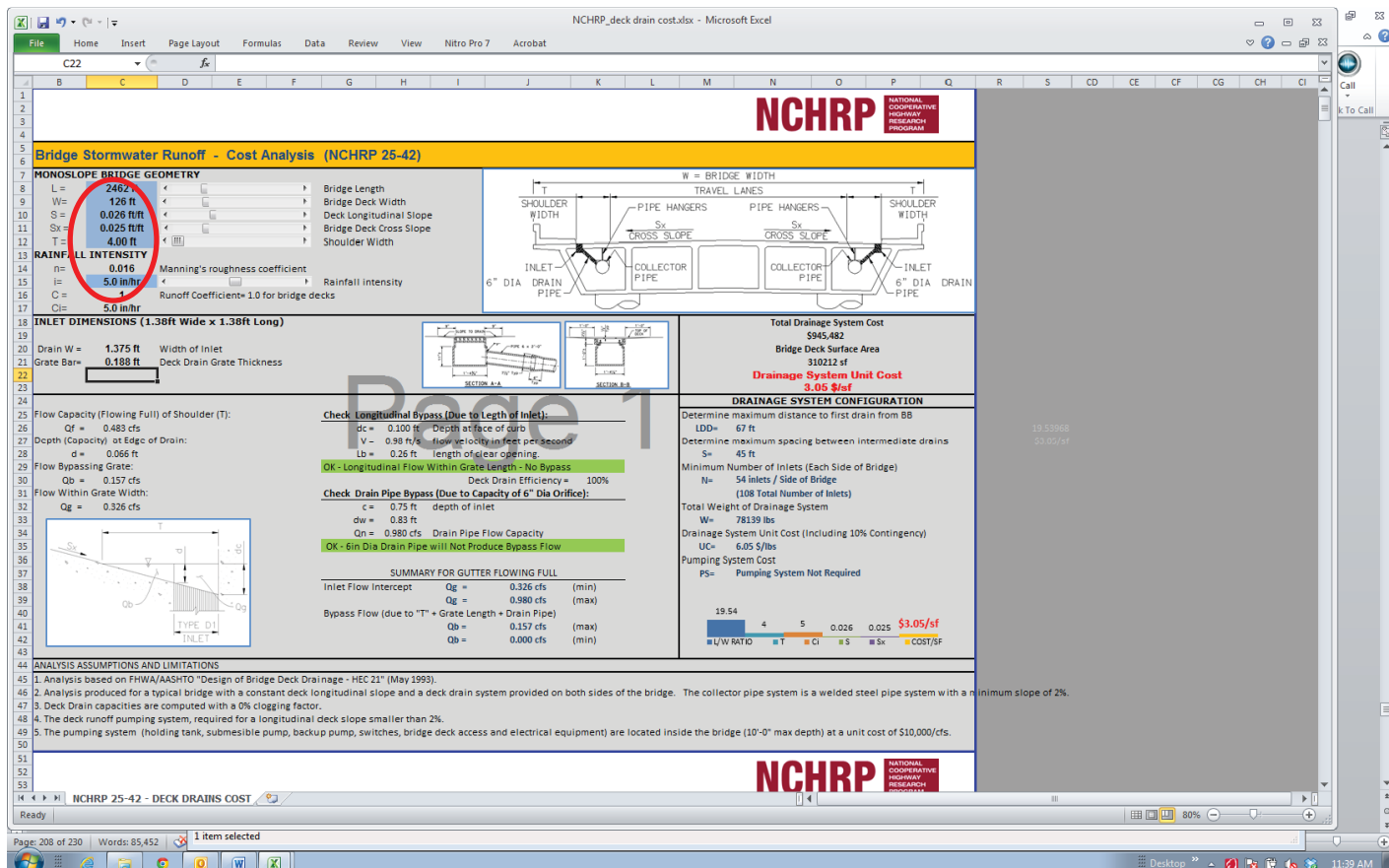

Figure D-16. Inputs and outputs for the bridge deck drainage system cost estimate tool.

runoff from the bridge deck if the longitudinal slope will not support a gravity drain system. Note that the pumping cost is provided to aid the practitioner in demonstrating the infeasibility of a pumped system. Pumping runoff from a bridge deck to comply with the requirements of an NPDES Permit is beyond the MEP standard.

## Cost Analysis Spreadsheet Tool for Bridge Deck Drainage Systems (NCHRP Project 25-42)

### Introduction

The design of any bridge deck drainage systems is based on the FHWA/AASHTO, “Hydraulic Engineering Circular No. 21,” (HEC-21) which provides strategies and procedures that guide the designer to obtain (as a final result) a feasible yet cost effective solution for stormwater management on bridge decks.

Properly designed bridge runoff drainage systems provide benefits related to traffic safety, maintenance, structural integrity, and aesthetics.

The bridge deck and gutters are surfaces that initially receive precipitation and if the bridge deck grades, super-elevations, and cross-slopes are properly designed, water and debris are efficiently conveyed through deck inlets and collector pipes to the bridge end abutment back into the main storm water system (Figures D-17 through D-21).

### Outcome

The purpose of this spreadsheet is to allow the user, during the planning stage to determine a relative cost of the drainage system (as a unit cost per square foot of bridge deck) for a constant grade/longitudinal slope and inlets on both sides of the bridge, restricted though, from a conservative cost perspective to a sole size inlet opening. For bridge decks with vertical alignments along curves, the user can split the bridge to be analyzed into two parts and determine an average cost.

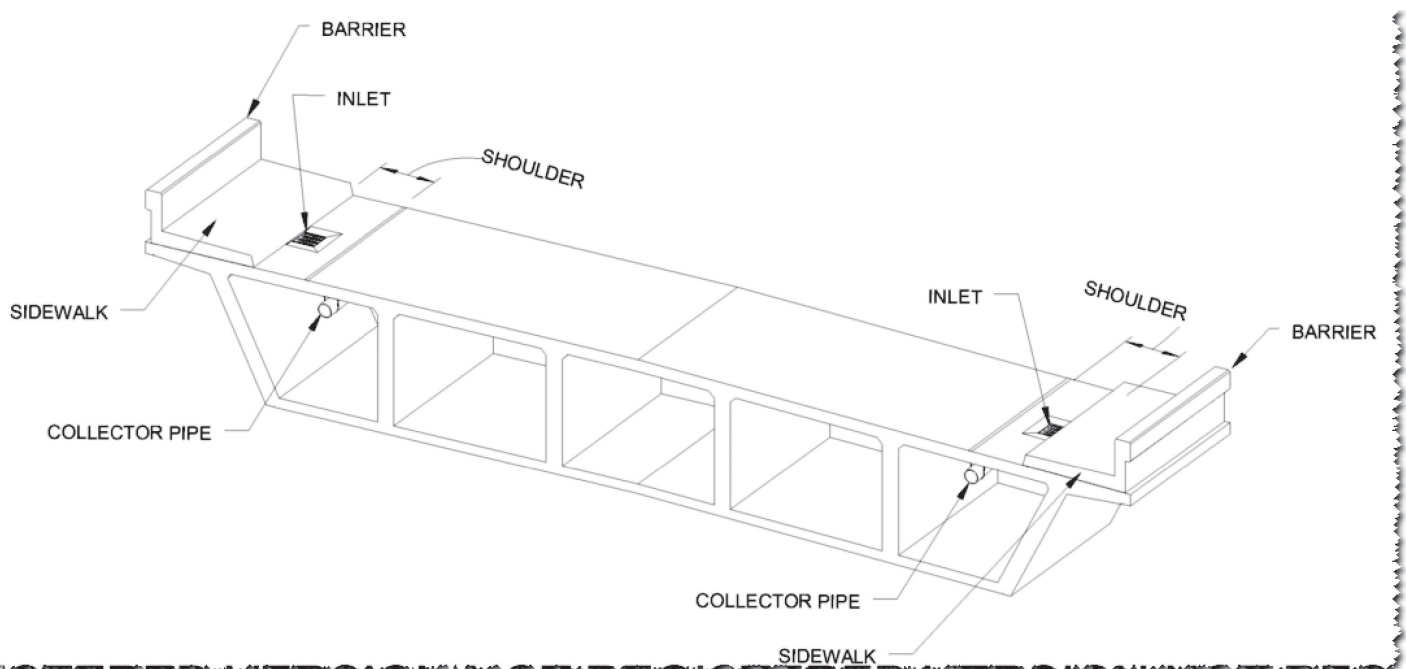
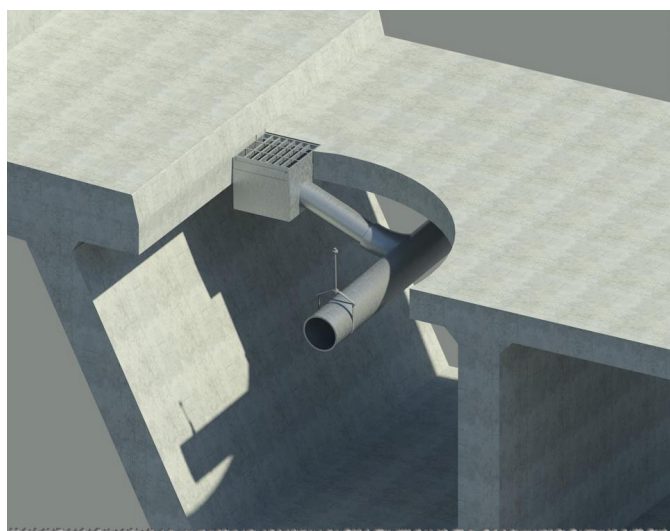

Figure D-17. Bridge deck drainage system components.

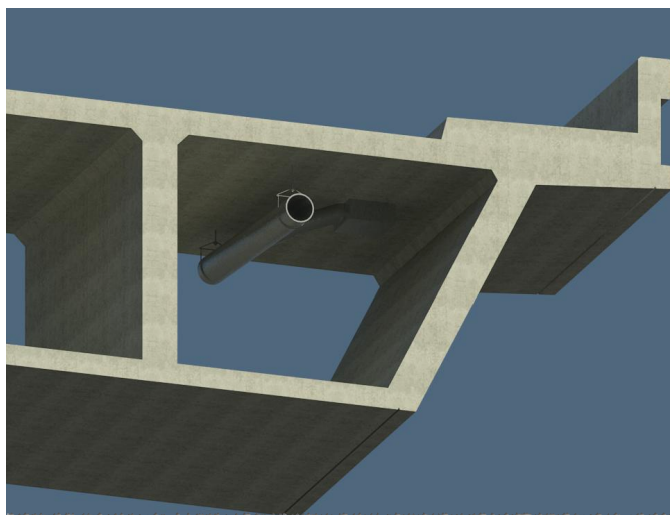



**Figure D-18. Bridge deck inlet.**



**Figure D-19. Inlet connection to collector pipe.**



**Figure D-20. Collector pipe.**

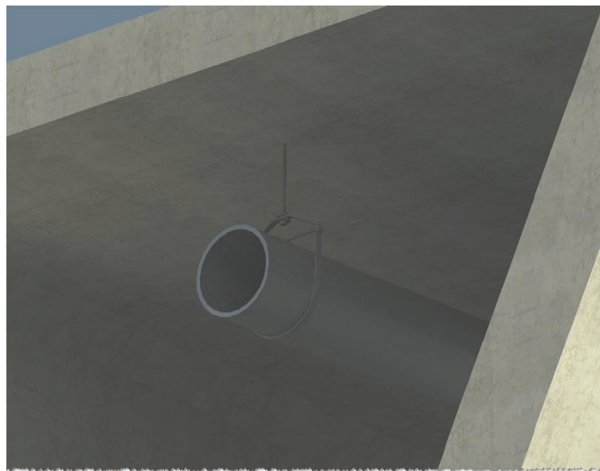

Figure D-21. Collector pipe hanger.

**Narrative**

The spreadsheet is subdivided into four main parts:

- Part 1: Input—Bridge Geometry/Rainfall Variables
- Part 2: Shoulder/Inlet Flow Capacity and Inlets Quantity/Spacing
- Part 3: Bridge Deck Drainage System Configuration
- Part 4: Deck Drainage Total Cost/Unit Cost

**Bridge Stormwater Runoff - Cost Analysis (NCHRP 25-42)**

**BRIDGE GEOMETRY**

**PART 1**

Bridge Length: 2 ft  
 Bridge Deck Width: 2 ft  
 Deck Longitudinal Slope: 0.630 ft/ft  
 Bridge Deck Cross Slope: 8.00 ft  
 Shoulder Width: 2 ft

**RAINFALL INTENSITY**

ne: 0.016 Manning's roughness coefficient  
 I: 5.0 in/hr Rainfall intensity  
 C: 1 Runoff Coefficient- 1.0 for bridge decks  
 Ci: 5.0 in/hr

**INLET DIMENSIONS (1.38ft Wide x 1.38ft Long)**

Drain V: 1.375 ft Width of Inlet  
 Grate Bars: 0.188 ft Deck Drain Grate Thickness

**Total Drainage System Cost: \$1,430,383**  
**Bridge Deck Surface Area: 500832 sf**  
**Drainage System Unit Cost: 2.86 \$/sf**

**PART 2**

of Shoulder (T):

Depth (Capacit) at Edge of Drain: d = 0.193 ft  
 Flow Bypassing Grate: Qb = 2.704 cfs  
 Flow Within Grate Width: Qg = 1.770 cfs

**Check Longitudinal Bypass (Due to Length of Inlet):**  
 do = 0.240 ft Depth at face of curb  
 V = 2.02 ft/s flow velocity in feet per second  
 Lb = 0.66 ft length of curb opening  
**OK - Longitudinal Flow Within Grate Length - No Bypass**

**Check Drain Pipe Bypass (Due to Capacity of 6" Dia Orifice):**  
 c = 0.75 ft depth of inlet  
 dw = 0.97 ft  
 Qn = 1.057 cfs Drain Pipe Flow Capacity  
**6in Dia Pipe will Produce Bypass Flow**

**SUMMARY FOR GUTTER FLOWING FULL**

Inlet Flow Intercept: Qg = 1.057 cfs (min)  
 Qg = 1.770 cfs (max)  
 Bypass Flow (due to "T" - Grate Length - Drain Pipe):  
 Qb = 3.416 cfs (max)  
 Qb = 2.704 cfs (min)

**DRAINAGE SYSTEM CONFIGURATION**

Determine maximum distance to first drain from BB  
**LDD= 552 ft**  
 Determine maximum spacing between intermediate drains  
**S= 130 ft**  
 Minimum Number of Inlets (Each Side of Bridge)  
**N= 24 inlets / Side of Bridge**  
**(48 Total Number of Inlets)**  
 Total Weight of Drainage System  
**W= 118213 lbs**  
 Drainage System Unit Cost (Including 10% Contingency)  
**UC= 6.88 \$/lbs**  
 Pumping System Cost  
**PS= Pumping System Not Required**

**ANALYSIS ASSUMPTIONS AND LIMITATIONS**

- Analysis based on FHWA/AASHTO "Design of Bridge Deck Drainage - HEC 21" (May 1993).
- Analysis produced for a typical bridge with a constant deck longitudinal slope and a deck drain system provided on both sides of the bridge. The collector pipe system is a welded steel pipe system with a minimum slope of 2%.
- Deck Drain capacities are computed with a 0% clogging factor.
- The deck runoff pumping system, required for a longitudinal deck slope smaller than 2%.
- The pumping system (holding tank, submersible pump, backup pump, switches, bridge deck access and electrical equipment) are located inside the bridge (10'-0" max depth) at a unit cost of \$10,000/cfs.

**NCHRP NATIONAL COOPERATIVE HIGHWAY RESEARCH PROGRAM**

**Bridge Stormwater Runoff - Cost Analysis (NCHRP 25-42)**

Part	Set	Bridge Section Area	Inlet Flow Demand	Required Shoulder Width	Requiree Height of Curb	Intercepte d Flow	Bg-Pass Flow	Flow in Collector Pipes	Collector Pipe Diameter	Collector Segment Lengths	Pipe Weights	Required No. of Hangers	Hangers Weight	Inlet Weights	Pumpin System
1	15-52	38902 sf	4.465 cfs	8.02 ft	0.24 ft	1.057 cfs	3.408 cfs	1.057 cfs	8 in	-	46 lbs	-	-	150	
2	16-82	9195 sf	1.055 cfs	4.67 ft	0.14 ft	0.638 cfs	0.418 cfs	1.475 cfs	8 in	130.43 ft	2410 lbs	14	281 lbs	150	
3	18-43	9195 sf	1.055 cfs	4.67 ft	0.14 ft	0.638 cfs	0.418 cfs	1.893 cfs	10 in	130.43 ft	3023 lbs	14	281 lbs	150	

## Part 1: Input—Bridge Geometry/Rainfall Variables

The user has the flexibility of varying the following input parameters:

BRIDGE GEOMETRY		
L =	3552 ft	Bridge Length
W =	141 ft	Bridge Deck Width
S =	0.030 ft/ft	Deck Longitudinal Slope
S <sub>x</sub> =	0.030 ft/ft	Bridge Deck Cross Slope
T =	8.00 ft	Shoulder Width
RAINFALL INTENSITY		
n =	0.016	Manning's roughness coefficient
i =	5.0 in/hr	Rainfall intensity
C =	1	Runoff Coefficient= 1.0 for bridge decks

- Length of bridge
- Width of bridge
- Width of gutter/shoulder
- Deck grade (longitudinal slope)
- Deck cross section slope
- Rainfall intensity

The length of the bridge can be varied from 60 ft to 10,000 ft. The width of the bridge can also be varied from 100 ft to 200 ft. The grade of the deck (longitudinal slope) ranges from 1% to 6% and the cross slope of the bridge typical section can have a varying slope from 2% to 4%.

The rainfall intensity is also an input and is established for Manning's roughness coefficient of 0.016 with a roughness coefficient of 1.0 for bridge decks. The rainfall intensity could vary as an input from 1 in./hour to 9 in./hour.

Since the tool is to be used at a planning phase, a required width of gutter (roadway shoulder) will have to be established as a particular essential part of the bridge system reserved for runoff. The user will determine the width of the gutter/shoulder (located on both sides of the bridge) based on the number of travelled lanes and bridge width. This value can be varied from 4 ft to 12 ft. The shoulder width will have the same value on both sides of the bridge.

INLET DIMENSIONS (1.38ft Wide x 1.38ft Long)		
Drain W =	1.375 ft	Width of Inlet
Grate Bar =	0.188 ft	Deck Drain Grate Thickness

The deck inlets are restricted to one size. Even though theoretically, the size of the inlet could be adjusted, a standard size 1.38 ft wide by 1.38 ft long inlet was chosen to restrict large inlet capacities since the spreadsheet does not allow for inlet capacity reduction due to clogging. The inlet is 1.38 ft deep and has a metal grating with a thickness of 0.1888 ft.

## Part 2: Shoulder/Inlet Flow Capacity and Inlets Amount/Spacing

The next part establishes the total flow capacity of the gutter/shoulder running full. A gutter is defined, for purposes of this discussion, as the section of bridge deck next to the barrier/

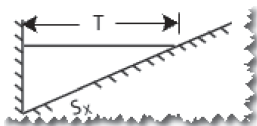

$$Q = (K/n) S_x^{5/3} S^{1/2} T^{8/3}$$

- K = 0.56;
- Q = flow rate, ft<sup>3</sup>/s;
- T = width of flow (spread), ft;
- S<sub>x</sub> = cross slope, ft/ft;
- S = longitudinal slope, ft/ft;
- n = Manning's coefficient

sidewalk, that conveys water during a storm runoff event. It may include a portion or all of the shoulder. Gutter cross sections usually have a triangular shape with the barrier/curb forming the near-vertical leg of the triangle.

Modification of the Manning equation is necessary for use in computing flow in triangular channels because the hydraulic radius in the equation does not adequately describe the gutter cross section, particularly where the top width of the water surface may be more than 40 times the depth at the curb. To compute gutter flow, the Manning equation is integrated for an increment of width across the section.

The flow depth at the edge of the inlet is then calculated based on the cross slope of the bridge section and width of the inlet. The bypassing flow (flow outside the perimeter of the inlet) is then calculated and the intercepted flow is a resultant of the total flow and the bypassing flow.

<p>Flow Capacity (Flowing Full) of Shoulder (T):                  Q<sub>f</sub> = 0.703 cfs</p> <p>Depth (Capacity) at Edge of Drain:                  d = 0.079 ft</p> <p>Flow Bypassing Grate:                  Q<sub>b</sub> = 0.228 cfs</p> <p>Flow Within Grate Width:                  Q<sub>g</sub> = 0.475 cfs</p>	<p><b>Check Longitudinal Bypass (Due to Length of Inlet):</b></p> <p>dc = 0.120 ft    Depth at face of curb                  V = 1.19 ft/s    flow velocity in feet per second                  Lb = 0.33 ft    length of clear opening.</p> <p style="background-color: #e0ffe0;">OK - Longitudinal Flow Within Grate Length - No Bypass</p> <p style="text-align: right;">Deck Drain Efficiency = 100%</p> <p><b>Check Drain Pipe Bypass (Due to Capacity of 6" Dia Orifice):</b></p> <p>c = 0.75 ft    depth of inlet                  dw = 0.85 ft                  Q<sub>n</sub> = 0.990 cfs    Drain Pipe Flow Capacity</p> <p style="background-color: #e0ffe0;">OK - 6in Dia Drain Pipe will Not Produce Bypass Flow</p>																				
	<p style="text-align: center;"><b>SUMMARY FOR GUTTER FLOWING FULL</b></p> <table border="0" style="width: 100%;"> <tr> <td style="width: 40%;">Inlet Flow Intercept</td> <td style="width: 20%;">Q<sub>g</sub> =</td> <td style="width: 20%;">0.475 cfs</td> <td style="width: 20%;">(min)</td> </tr> <tr> <td></td> <td>Q<sub>g</sub> =</td> <td>0.990 cfs</td> <td>(max)</td> </tr> <tr> <td colspan="4">Bypass Flow (due to "T" + Grate Length + Drain Pipe)</td> </tr> <tr> <td></td> <td>Q<sub>b</sub> =</td> <td>0.228 cfs</td> <td>(max)</td> </tr> <tr> <td></td> <td>Q<sub>b</sub> =</td> <td>0.000 cfs</td> <td>(min)</td> </tr> </table>	Inlet Flow Intercept	Q <sub>g</sub> =	0.475 cfs	(min)		Q <sub>g</sub> =	0.990 cfs	(max)	Bypass Flow (due to "T" + Grate Length + Drain Pipe)					Q <sub>b</sub> =	0.228 cfs	(max)		Q <sub>b</sub> =	0.000 cfs	(min)
Inlet Flow Intercept	Q <sub>g</sub> =	0.475 cfs	(min)																		
	Q <sub>g</sub> =	0.990 cfs	(max)																		
Bypass Flow (due to "T" + Grate Length + Drain Pipe)																					
	Q <sub>b</sub> =	0.228 cfs	(max)																		
	Q <sub>b</sub> =	0.000 cfs	(min)																		

The capacity of the intercepted flow is now established; however for inlets with a length of 1.38 ft, for runoff velocities larger than 3.6 ft/s, the intercepted flow will not be captured in its entirety due to splash over. The splash over is a function of grate efficiency and can be estimated for higher flow velocities using the following equation which approximates test results.

$$E = 100 - 30 (V - 3.6) \leq 100\%$$

A theoretical length of clear opening is calculated from the depth of the flow at the face of the curb and flow velocity. If the length of clear opening is smaller than the actual inlet width, the intercepted flow is collected fully. If the velocity is exceeded, the capacity of the inlet is reduced as a percentage based on the above equation. Flow not intercepted continues to the next inlet.

Finally, the capacity of the inlet could be dictated by the capacity of the 6 in. diameter drain pipe (see equation below) which connects the inlet to the collector system of pipes. If the drain pipe capacity inside diameter is smaller than the intercepted flow, the capacity of the inlet will be controlled by the 6 in. diameter drain pipe.

$$Q = 0.67A (2gd)^{1/2} = 5.37 A (d)^{1/2}$$



The distance from the beginning of bridge to the first inlet is then calculated at a point at which the flow width equals the shoulder width. The spacing of the drains is then a resultant of the flow intercepted and width of bridge. The number of required inlet is the ratio of the distance between the first drain and the end of the bridge to the spacing of the inlets plus one.

Determine maximum distance to first drain from BB  
 LDD= 87 ft  
 Determine maximum spacing between intermediate drains  
 S= 59 ft  
 Minimum Number of Inlets (Each Side of Bridge)  
 N= 60 inlets / Side of Bridge  
 (120 Total Number of Inlets)

### Part 3: Bridge Deck Drainage System Configuration

Since the number of inlets is established, the location (stations along the bridge) of the inlets could be easily determined.

Bridge Stormwater Runoff - Cost Analysis (NCHRP 25-42)															
Inlet #	Deck Inlet Station	Bridge Section Area	Inlet Flow Demand	Required Shoulder Width	Requiree Height of Curb	Intercepte d Flow	By-Pass Flow	Flow in Collector Pipes	Collector Pipe Diameter	Collector Segment Lengths	Pipe Weights	Required No. of Hangers	Hangers Weight	Inlet Weights	Pumpin System
1	15+52	38902 sf	4.465 cfs	8.02 ft	0.24 ft	1.057 cfs	3.408 cfs	1.057 cfs	8 in	-	46 lbs	-	-	150	
2	16+32	9195 sf	1.055 cfs	4.67 ft	0.14 ft	0.638 cfs	0.418 cfs	1.475 cfs	8 in	130.43 ft	2410 lbs	14	281 lbs	150	
3	18+13	9195 sf	1.055 cfs	4.67 ft	0.14 ft	0.638 cfs	0.418 cfs	1.893 cfs	10 in	130.43 ft	3023 lbs	14	281 lbs	150	
4	19+43	9195 sf	1.055 cfs	4.67 ft	0.14 ft	0.638 cfs	0.418 cfs	2.311 cfs	10 in	130.43 ft	3023 lbs	14	281 lbs	150	
5	20+74	9195 sf	1.055 cfs	4.67 ft	0.14 ft	0.638 cfs	0.418 cfs	2.728 cfs	12 in	130.43 ft	3584 lbs	14	281 lbs	150	
6	22+04	9195 sf	1.055 cfs	4.67 ft	0.14 ft	0.638 cfs	0.418 cfs	3.146 cfs	12 in	130.43 ft	3584 lbs	14	281 lbs	150	

The bridge section area is the tributary area of each inlet based on the stationing determined in the previous step. The flow demand in each inlet is determined based on the rational method, and the actual gutter flow required to sustain the determined flow is computed in the next column.

The width of the shoulder required should always be smaller than the proposed maximum width of gutter established at the beginning of the spreadsheet.

The flow velocity, intercepted flow, and bypass flow are also computed for the actual demands on the inlets using the same methodology used in the first part of the spreadsheet.

The flow collected by the inlets will be transferred to the collector pipes as intercepted flow at the inlet plus the bypass flow generated by the previous inlets. The pipe size required for the collector pipe system is determined based on the cross sectional area of the pipe and flow velocity.

The length of the collector pipes is determined from the inlet stationing and the weight of each pipe segment is determined based on the unit weight for a certain pipe size and pipe length. The collector pipe system is anchored to the bottom of the bridge deck with steel hangers that are spaced at 10 ft OC. The weight of the hangers is determined as a product between an average hanger height. The inlets weight is the weight of a galvanized steel box inlet. Each 6 in. drain pipe segment weight is also accounted being located at each inlet location.

The pumping system required inside the bridge is a combination of holding tank, submersible pump, backup pump, switches, and other miscellaneous electrical equipment. The cost of the pumping system is determined based on an average unit cost of \$10,000 per cfs of runoff flow needed to be pumped. The location along the bridge where pumping station are required is based on a fixed 2% slope for the collection piping system and the available space inside the bridge. Note that pumping system costs are provided for reference only, to assist the practitioner in demonstrating the infeasibility of providing a pumped system to facilitate treatment of bridge deck runoff at the abutment. The whole life costs of a pumping system clearly exceed the MEP standard, and alternative methods for compliance discussed in Chapter 4 of this guide should be considered.

The cost of each item is determined based on the weight of the item and a unit cost (including 10% contingency) of \$6.10/lb of steel.

The sum of the cost of the inlets, drain pipes, collector pipes, hangers, and pumping system (if it occurs) is the cost of the runoff drainage system.

#### **Part 4: Deck Drainage Total Cost/Unit Cost**

The cost per square foot of bridge is then determined by simply dividing the total cost of the drainage system by the total area of the bridge.

<b>Total Drainage System Cost</b>
\$1,559,961
<b>Bridge Deck Surface Area</b>
500832 sf
<b>Drainage System Unit Cost</b>
<b>3.11 \$/sf</b>

---

## APPENDIX E

# BMP Evaluation Tool Modeling Methodology

This appendix summarizes the modeling methodology and underlying data used in the BMP Evaluation Tools.

### Introduction and Purpose

This document summarizes the modeling methodology, assumptions, and default parameters used in the development of the BMP Evaluation Tools. These tools can be used to estimate average annual runoff volumes and pollutant loads before and after BMP construction and estimate construction and lifecycle costs associated with the BMP. These tools can be used for a variety of scenarios, pollutants, and BMP types installed to treat bridge deck runoff to aid in the decision-making process regarding BMP type and sizing. The predicted load reduction is caused by decreases in pollutant concentrations and reduction in runoff volume. Concentration reductions are estimated using the difference in concentrations between characteristic highway runoff quality (influent) and estimated BMP effluent data based on regression analyses of paired influent and effluent composite data from the International Stormwater BMP Database. Volume reductions are based on long-term continuous simulation hydrologic modeling using the EPA's Storm Water Management Model (SWMM). The results of the regression analyses and hydrologic modeling are combined to provide load reduction estimates. The following sections describe the approach and assumptions for estimating highway runoff quality, conducting the regression analyses, and performing and summarizing the results from hydrologic modeling.

### Pollutants and BMPs Analyzed

The pollutants analyzed and supported in the BMP Tools include total zinc (TZn), total lead (TPb), total copper (TCu), total nitrogen (TN), total phosphorus (TP), nitrate ( $\text{NO}_3^-$ ), total Kjeldahl nitrogen (TKN), dissolved phosphorus (DP), total suspended solids (TSS), *Escherichia coli* (E. coli),

and fecal coliforms (FC). A separate tool has been developed for each of the following BMPs: vegetated swales, dry detention basins, bioretention, sand filters, and permeable friction course (PFC) overlay.

### Highway Runoff Quality

Highway runoff quality data were obtained from the Highway-Runoff Database (HRDB) (Granato and Cazenav 2009; Smith and Granato 2010) and the National Stormwater Quality Database (NSQD) (Pitt 2008). Tables E-1 and E-2 summarize the data available for the two databases, before 1986. Data before 1986 were excluded in the analysis because of the use of leaded gasoline that caused an unrepresentative sample of modern conditions. The HRDB provides nearly three times as much highway runoff data as the NSQD.

To assess the impact of average annual daily traffic (AADT) on constituent concentration, five AADT categories were created: 0-25,000; 25,000-50,000; 50,000-100,000; 100,000+; and unknown. As noted in Table E-3, these categories provide a reasonable division of the data, with a fairly balanced distribution of the data between categories. In general, the 25K-50K category has the least data. Fecal coliform data are sparse in all categories and no categorization was possible with the E. coli data. Values for TN are sparse and TKN values were used where there was no data.

Table E-4 summarizes the arithmetic means and 90% confidence intervals about those means for each AADT bin. To handle non-detects, a robust regression-on-order statistics (ROS) method as described by Helsel and Cohn (1988) was utilized to provide probabilistic estimates of non-detects before computing descriptive statistics. Confidence intervals were generated using the bias corrected and accelerated (BCa) bootstrap method described by Efron and Tibishirani (1993). This method for computing confidence intervals is resistant to outliers and does not require any restrictive distributional assumptions common with parametric confidence intervals.

**Table E-1. Summary of available data.**

	NSQD	HRDB	Combined
# of sites	43	93	136
# of events	669	1,537	2,206
# of sample results	3,027	8,813	11,184
# ND	41	458	499

As indicated by the confidence intervals in Table E-4, there does not appear to be a clear relationship between AADT and pollutant concentration except for possibly dissolved phosphorus, total copper, and total zinc, particularly when comparing the low traffic AADT (<25K) against the high traffic AADT (>50K). Therefore, for the purposes of developing the BMP Evaluation Tools, the default concentrations used for characterizing runoff from bridge decks is the mean concentrations for all of the data combined regardless of AADT. Tool users have the option of overriding this default with a value from the table or from other monitoring data.

### Regression Analysis

The International Stormwater BMP Database (BMP Database) is a repository of influent and effluent water quality data from over 500 BMP studies. This database provides an avenue for a data-driven analysis of the relationship between influent concentration ( $C_{inf}$ ) and effluent concentration ( $C_{eff}$ ) for a wide range of BMP-pollutant combinations. Pollutants analyzed in this study included total suspended solids (TSS), total zinc (TZn), total lead (TPb), total copper (TCu), total nitrogen (TN), total phosphorus (TP), nitrate ( $NO_3^-$ ), total Kjeldahl nitrogen (TKN), dissolved phosphorus (DP), ortho-phosphate (OP) as a surrogate for DP when needed, fecal coliform (FC), and *Escherichia coli* (E. coli). TN is estimated as the sum of  $NO_3^-$  and TKN (nitrite is assumed negligible). The BMPs analyzed in this effort included swales, detention basins, bioretention, and sand filters. Permeable friction course (PFC)

**Table E-2. Summary of non-detects and total samples for each constituent.**

Constituent	Non-detects/ Total Samples
TSS	11 / 1,713
NO3	92/1,047
TN	0 / 122
TKN	49 / 1,408
DP	32 / 217
TP	120 / 2,022
TCu	72 / 1,808
TPb	102 / 1,683
TZn	12 / 2,099
Fecal Col.	0 / 65
Total E. coli	0 / 13

was also considered, but there are insufficient data available to evaluate influent and effluent relationships.

Data from the BMP Database were analyzed using a multi-step process. This process is shown in Figure E-1 and consists of five steps:

- Determine if sufficient paired data for analysis exist in the BMP Database
- Determine if there is a statistical difference between  $C_{inf}$  and  $C_{eff}$
- Determine if a monotonic relationship between  $C_{inf}$  and  $C_{eff}$  exists
- Conduct linear, log-linear, and log-log regression between  $C_{inf}$  and  $C_{eff}$  and develop functional relationship
- Ensure results do not show logical inconsistencies (e.g., dissolved fraction is greater than total)

Since water quality data are often highly variable and positively skewed, nonparametric statistics were selected over

**Table E-3. Count of sample results by constituents by average annual daily traffic.**

Constituent	AADT Bin				Unknown	All
	0 - 25K	25K - 50K	50K - 100K	100K +		
TSS	388	198	301	563	263	1713
NO3	355	151	191	350	0	1047
TN	0	0	3	0	119	122
TKN	336	146	176	412	338	1408
DP	46	38	28	73	32	217
TP	428	264	332	508	490	2022
TCu	426	243	304	555	280	1808
TPb	402	240	264	492	285	1683
TZn	424	253	323	569	530	2099
FC	3	0	4	19	39	65
E. coli	0	0	0	0	13	13



**Table E-4. Means and confidence intervals for combined NSQD and HRDB data.**

Constituent	AADT Bin					
	0 - 25K	25K - 50K	50K - 100K	100K+	Unknown	All
TSS (mg/L)	162.76	178.28	120.08	143.61	85.18	138.84
	(136.12-190.42)	(127.11-233.81)	(95.05-150.62)	(130.62-157.11)	(72.84-98.43)	(127.37-150.25)
NO3 (mg/L)	0.48	1.12	0.82	1.74	No Data	1.06
	(0.42-0.53)	(0.94-1.32)	(0.73-0.92)	(1.51-2.02)		(0.96-1.16)
TN (mg/L)	No Data	No Data	3.61	No Data	3.59	3.59
			(2.30-4.68)		(3.17-4.03)	(3.18-4.02)
TKN (mg/L)	1.62	2.5	1.9	3.18	2.11	2.32
	(1.45-1.81)	(2.23-2.76)	(1.72-2.09)	(2.84-3.50)	(1.94-2.28)	(2.20-2.44)
DP (mg/L)	0.09	0.14	0.12	0.54	0.09	0.25
	(0.08-0.10)	(0.11-0.17)	(0.09-0.15)	(0.32-0.81)	(0.07-0.11)	(0.17-0.34)
TP (mg/L)	0.38	0.46	0.25	0.39	0.68	0.44
	(0.27-0.49)	(0.29-0.63)	(0.23-0.28)	(0.34-0.44)	(0.47-0.99)	(0.37-0.52)
TCu (ug/L)	14.92	26.83	30.79	82.11	27.11	41.76
	(13.50-16.44)	(24.18-29.42)	(28.23-33.32)	(60.65-114.55)	(20.29-35.10)	(34.68-51.86)
TPb (ug/L)	18.26	31.29	26.24	61.6	77.63	44.08
	(10.17-30.10)	(26.36-36.73)	(21.38-31.64)	(53.81-70.28)	(70.32-85.98)	(40.37-48.32)
TZn (ug/L)	98.02	152.1	172.72	329.63	142.98	189.93
	(87.65-108.00)	(133.09-170.64)	(157.56-188.22)	(287.03-382.57)	(128.10-157.58)	(176.81-205.66)
FC (MPN/100 mL)	6147.73	No Data	5625.2	8701.79	9215.27	8699.89
	(300.00-10333.33)		(1700.00-8575.00)	(1794.64-15786.44)	(3519.61-16607.39)	(4518.54-13556.63)
E. coli (MPN/100 mL)	No Data	No Data	No Data	No Data	5948.28	6025.22
					(1716.92-12641.77)	(1714.13-12654.39)

parametric statistics for this analysis. The Wilcoxon signed rank test was used to evaluate whether the influent and effluent concentrations are statistically different and the Spearman's rho correlation coefficient was used to evaluate whether a monotonic relationship exists (Helsel and Hirsch 2002). The Wilcoxon signed ranked test assumes the distribution of the paired differences is symmetric, so the data were log-transformed prior to conducting the test. No transformation was needed for the Spearman's rho computation because the correlation analysis uses the ranks of the data.

If the Wilcoxon test found a statistically significant difference between the influent and effluent concentrations, and the Spearman's rho test found that a monotonic relationship exists, regression equations were developed using the Kendall-

Theil robust line procedure described by Granato (2006). Linear and log-linear relationships were evaluated and the best fit equation was used based on the median absolute difference. Statistical significance for all analyses was determined at a level of  $\alpha = 0.10$ . The analysis results are presented and discussed.

### Sufficient Paired Data for Analysis

Paired data, those for which both influent and effluent concentrations were measured on the same BMP for the same rainfall event, were the only data used for this analysis. This was done to eliminate the impact of miscellaneous variables that might influence either influent or effluent quality separately. A minimum of 3 distinct studies and 20 distinct influent/effluent

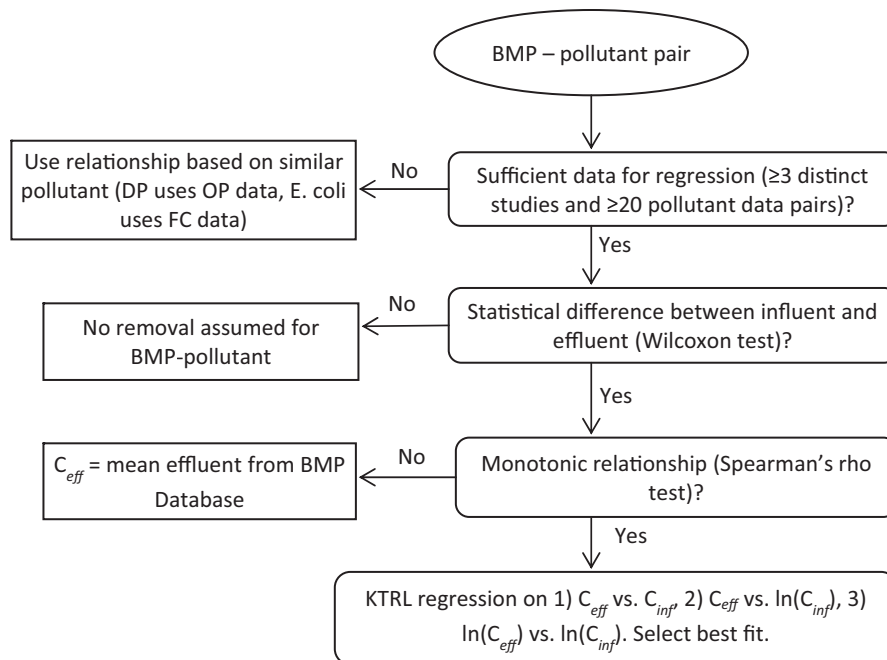

Figure E-1. Analysis process for influent-effluent regression.

measurement pairs was set. PFC was the only BMP with only one study in the BMP Database.

Table E-5 summarizes the number of data pairs by BMP and constituent. As shown, the PFC study had no data available for OP, FC, or E. coli. OP was also not available for detention basins and E. coli was not available for sand filters.

### Statistical Difference between Influent and Effluent Quality

While some pollutants, such as TSS, are easily removed by a wide variety of BMPs, others, such as NO<sub>3</sub><sup>-</sup>, are more difficult to remove. The non-parametric Wilcoxon signed-rank test was used to verify a statistical difference between influent and effluent quality for each BMP-pollutant pair in

order to determine if removal of a pollutant was occurring in a BMP. Because this test requires a symmetric distribution, the data were log-transformed prior to performing the analysis. As shown in Table E-6, several BMP-pollutant combinations involving nutrients and bacteria indicators show statistically significant concentration reductions (p>0.1 means no statistically significant reduction). In these instances, no removal would be assumed in the BMP Evaluation Tools.

### Monotonic Relationship between Influent and Effluent

The next step in this process required establishing the presence of a monotonic relationship between influent and effluent

Table E-5. Number of data pairs by BMP and constituent.

Constituent	BMP Type				
	Bioretention	Grass Swale	Detention Basin	Sand Filter	PFC*
TSS	171	195	265	296	22
NO <sub>3</sub> <sup>-</sup>	19	77	105	158	22
TKN	160	92	59	127	0
DP	167	151	176	270	22
OP	21	52	117	65	22
TP	123	26	34	99	0
TCu	214	191	245	286	22
TPb	67	119	191	267	22
TZn	54	138	193	248	22
FC	110	152	209	293	22
E. coli	26	79	109	121	0

\*PFC pairs are based on paired watershed data as influent concentration for this BMP was unavailable.

**Table E-6. Wilcoxon signed-rank test  $p$ -values.**

Constituent	BMP Type				
	Bioretention	Grass Swale	Detention Basin	Sand Filter	PFC
TSS	<0.001	<b>0.023</b>	<0.001	<0.001	<0.001
NO <sub>3</sub> <sup>-</sup>	NA	<0.001	<0.001	<0.001	0.118
TKN	<b>0.037</b>	0.485	<0.001	<0.001	<0.001
DP	<b>0.035</b>	<0.001	0.659	<b>0.066</b>	0.239
OP	<0.001	<0.001	0.458	<0.001	NA
TP	0.984	<0.001	<0.001	<0.001	<0.001
TCu	<0.001	<0.001	<0.001	<0.001	<0.001
TPb	<0.001	<0.001	<0.001	<0.001	<0.001
TZn	<0.001	<0.001	<0.001	<0.001	<0.001
FC	<0.001	0.525	<b>0.007</b>	<0.001	NA
E. coli	<b>0.026</b>	0.128	<0.001	NA	NA

Values in bold indicate no statistically significant reduction from influent to effluent

quality. To do this, the Spearman's rho test was applied to each BMP-pollutant combination. Those combinations showing a statistically significant difference between influent  $C_{inf}$  and  $C_{eff}$  generally exhibited a monotonic relationship between the two. The only exceptions were the swale-DP combination and all available constituent data for PFC where a statistically significant monotonic relationship between  $C_{inf}$  and  $C_{eff}$  was not observed. In these cases, a regression analysis was not performed. However, since the Wilcoxon test results indicate a statistically significant reduction in DP for swales and a statistically significant reduction in all constituents except for NO<sub>3</sub><sup>-</sup> and DP for PFC, the arithmetic estimate of the log mean of effluent concentration data from the BMP Database was selected as an appropriate estimate of  $C_{eff}$  for these BMP-constituent combinations. Note

that when implementing constant effluent concentrations in the BMP Evaluation Tool, the BMPs are assumed to never be a source of pollutants. Therefore, if  $C_{inf}$  is estimated to be less than  $C_{eff}$ , then no concentration reduction is assumed in the tool.

As shown in Table E-7, the correlation analysis for PFC indicates that the effluent concentrations for all available pollutants are not correlated with the influent concentrations because no  $p$ -value is  $< 0.1$ . Viewing these results with the Wilcoxon signed rank test results, it is concluded that average effluent concentrations independent of influent concentrations are appropriate for all pollutants except for NO<sub>3</sub><sup>-</sup> and DP. No removal will be assumed for these two constituents and no removal will also be assumed for E. coli due to lack of data.

**Table E-7. Spearman's rho test results ( $p$ -value in parentheses).**

Constituent	BMP Type				
	Bioretention	Grass Swale	Detention Basin	Sand Filter	PFC
TSS	<b>0.30</b> ( <b>&lt;0.001</b> )	<b>0.46</b> ( <b>&lt;0.001</b> )	<b>0.55</b> ( <b>&lt;0.001</b> )	<b>0.41</b> ( <b>&lt;0.001</b> )	0.2 (0.286)
NO <sub>3</sub> <sup>-</sup>	NA	<b>0.89</b> ( <b>&lt;0.001</b> )	<b>0.79</b> ( <b>&lt;0.001</b> )	<b>0.75</b> ( <b>&lt;0.001</b> )	0 (0.636)
TKN	<b>0.57</b> ( <b>&lt;0.001</b> )	<b>0.73</b> ( <b>&lt;0.001</b> )	<b>0.70</b> ( <b>&lt;0.001</b> )	<b>0.71</b> ( <b>&lt;0.001</b> )	0.07 (0.389)
DP	-0.06 (0.786)	<b>0.68</b> ( <b>&lt;0.001</b> )	<b>0.67</b> ( <b>&lt;0.001</b> )	<b>0.69</b> ( <b>&lt;0.001</b> )	0.05 (0.416)
OP	<b>0.46</b> ( <b>&lt;0.001</b> )	<b>0.80</b> ( <b>&lt;0.001</b> )	<b>0.67</b> ( <b>&lt;0.001</b> )	<b>0.65</b> ( <b>&lt;0.001</b> )	NA
TP	<b>0.38</b> ( <b>&lt;0.001</b> )	<b>0.63</b> ( <b>&lt;0.001</b> )	<b>0.66</b> ( <b>&lt;0.001</b> )	<b>0.71</b> ( <b>&lt;0.001</b> )	0.36 (0.207)
TCu	<b>0.41</b> ( <b>&lt;0.001</b> )	<b>0.81</b> ( <b>&lt;0.001</b> )	<b>0.87</b> ( <b>&lt;0.001</b> )	<b>0.61</b> ( <b>&lt;0.001</b> )	0.27 (0.245)
TPb	NA	NA	<b>0.90</b> ( <b>&lt;0.001</b> )	<b>0.71</b> ( <b>&lt;0.001</b> )	0.29 (0.236)
TZn	<b>0.49</b> ( <b>&lt;0.001</b> )	<b>0.82</b> ( <b>&lt;0.001</b> )	<b>0.72</b> ( <b>&lt;0.001</b> )	<b>0.43</b> ( <b>&lt;0.001</b> )	0.19 (0.291)
FC	<b>0.70</b> ( <b>&lt;0.001</b> )	<b>0.83</b> ( <b>&lt;0.001</b> )	<b>0.65</b> ( <b>&lt;0.001</b> )	<b>0.70</b> ( <b>&lt;0.001</b> )	NA
E. coli	<b>0.34</b> ( <b>0.012</b> )	<b>0.83</b> ( <b>&lt;0.001</b> )	<b>0.58</b> ( <b>&lt;0.001</b> )	NA	NA

Values in bold indicate no statistically significant correlation between influent and effluent

### Regression Analysis of the Relationship between Influent and Effluent

Based on the results of the Wilcoxon and Spearman’s rho tests, several BMPs appear to provide statistically significant reductions in pollutant concentrations along with monotonic influent/effluent relationships. These results together indicate that regression analyses can be conducted to develop functional relationships that can be used to predict BMP performance.

Given the prevalence of outliers in environmental data and the strong influence these outliers can have on standard linear regression techniques, the nonparametric Kendall-Theil robust line (KTRL) (Granato 2006) regression method was selected for this analysis. The KTRL method computes the slopes between all possible combinations of two data points and selecting the median of these slopes. A y-intercept is then calculated according to the formula:

$$Intercept = median(y) - (median\ slope) * median(x) \quad (Eq. 1)$$

Similar to linear regression, the calculation of slope and intercept creates a line of the form  $y = m * x + b$  that can then be used as a generalized relationship between x and y.

Pollutant concentrations in stormwater often exhibit a lognormal, rather than a normal distribution. Consequently, both linear and log-linear forms of the influent and effluent regression equations were considered in the analysis. Kendall-Theil robust lines were calculated for three possible relationships between influent and effluent, as shown in Table E-8.

The median absolute deviation (MAD) was used to select the best regression equation for each BMP-pollutant combination. This statistic is defined by:

$$MAD = median(|C_{eff} - C_{predicted}| \text{ for all values of } C_{eff}) \quad (Eq. 2)$$

where  $C_{predicted}$  is the value of the  $C_{eff}$  predicted by the Kendall-Theil regression line.

### Equation Selection and Regression Parameters

Regression equations were developed using all available storm event data pairs for each BMP-pollutant combination

**Table E-8. KTRL equations used for nonparametric regression.**

Data pairs plotted for KTRL Calculations	KTRL Equation Derived
$C_{eff}, C_{inf}$	$C_{eff} = m * C_{inf} + b$
$C_{eff}, \ln(C_{inf})$	$C_{eff} = m * \ln(C_{inf}) + b$
$\ln(C_{eff}), \ln(C_{inf})$	$\ln(C_{eff}) = m * \ln(C_{inf}) + b$

where both a statistically significant reduction was observed (Wilcoxon) and a monotonic relationship was found. BMPs are assumed to not be a source of pollutants and thus effluent concentrations will not exceed the influent concentrations or load. Some BMPs can contribute to constituent concentrations, but including this assumption in the analysis introduced difficulty accounting for mass balance. Table E-9 summarizes the form of equation selected for each BMP-pollutant combination based on the hypothesis test results and the best fit regression equation.

Based on the various possible influent-effluent relationships considered in Table E-6, a generalized equation was developed as follows:

$$C_{eff} = \min[C_{inf}, \max(A + B * C_{inf} + C * \ln(C_{inf}) + D * C_{inf}^E + e_i, DL)] \quad (Eq. 3)$$

where  $C_{eff}$  is the predicted effluent concentration,  $C_{inf}$  is the predicted influent concentration, A, B, C, D, and E are parameters of the equation,  $e_i$  is the bias correction factor for equation 3, and DL is the minimum detection limit observed for the available data sets. This equation ensures that BMPs are not a source of pollutants (e.g.,  $C_{eff}$  is never greater than  $C_{inf}$ ) and predicted effluent concentration is never below a reported detection limit (Tables E-10–E-14).

The regression equations are used to represent the average performance for each BMP type. The BMP Evaluation Tools are not intended to model event-by-event loads. For a particular site, the equations are used to produce a single average effluent concentration given an average influent concentration.

### Hydrologic Modeling and Rainfall Data Analysis

A large number of long-term continuous simulation modeling scenarios were performed using EPA SWMM5 to provide the hydrologic performance data for specific BMP configurations and locations that the user may desire to analyze. Three hundred forty-three (343) National Climatic Data Center (NCDC) Cooperative Observer Program (COOP) rain gages with hourly rainfall data and covering all of the major climatic regions of the contiguous United States were selected for continuous simulation model runs. A variety of unit area storage volumes and drawdown characteristics were simulated for each rainfall record. Summary statistics, including the 85th and 95th percentile storm event depths and the average annual rainfall depth, were computed for each rain gage. The percentile storm events are used to scale modeling results to better match the site specific hydrology of user’s study area. The average annual rainfall depths are used to estimate the average annual runoff volume to a BMP.



**Table E-9. Equation selection summary for BMP-pollutant combinations.**

Pollutant	Bioretention	Grass Swale	Detention Basin	Sand Filter	PFC
TSS	3	3	3	3	8
NO <sub>3</sub> <sup>-</sup>	4	1	1	1	4
TKN	2	4	1	1	8
TN	9	9	9	9	9
DP	8	1	4	1	4
TP	4	2	2	2	8
TCu	3	3	3	3	8
TPb	4	3	1	1	8
TZn	3	3	3	3	8
FC	3	4	3	3	4
E. coli	3	4	3	7	4

- 1 - KTRL regression of  $C_{eff}$  vs.  $C_{inf}$ .
- 2 - KTRL regression of  $C_{eff}$  vs.  $\ln(C_{inf})$ .
- 3 - KTRL regression of  $\ln(C_{eff})$  vs.  $\ln(C_{inf})$ .
- 4 - Failed Wilcoxon test or lack of data for analysis. No removal assumed.
- 5 - Insufficient data for DP analysis. KTRL line ( $C_{eff}$  vs.  $\ln(C_{inf})$ ) based on OP data.
- 6 - Insufficient data for DP analysis. OP data failed Wilcoxon test. No removal assumed.
- 7 - Insufficient paired data for analysis. Used data for fecal coliform to develop equation parameters for this BMP.
- 8 - Failed Spearman's test for monotonic relationship, but passed Wilcoxon test.  $C_{eff}$  = arithmetic estimate of log mean for all available effluent data in the BMP Database using regression-on-order statistics for handling non-detects followed by bootstrapping as described in Geosyntec and WWE (2012).
- 9 - To be determined by addition of NO<sub>3</sub> and TKN (nitrite assumed negligible).

**Table E-10. Equation parameters for predicting bioretention effluent concentrations.**

Pollutant	A	B	C	D	E	$e_i$	DL
TSS (mg/L)	0.00	0.00	0.00	2.49	0.37	1.35	0.00
NO <sub>3</sub> <sup>-</sup> (mg/L)	0.00	1.00	0.00	0.00	0.00		0.00
TKN (mg/L)	0.83	0.00	0.50	0.00	0.00	0.71	0.04
TN (mg/L)	<-- TN = TKN + NO3 -->						
DP (mg/L)	-0.82	0.00	0.00	0.00	0.00		0.03
TP (mg/L)	0.00	1.00	0.00	0.00	0.00		0.01
TCu (ug/L)	0.00	0.00	0.00	2.77	0.44	1.26	0.50
TPb (ug/L)	0.00	1.00	0.00	0.00	0.00		1.00
TZn (ug/L)	0.00	0.00	0.00	1.11	0.68	1.26	0.01
FC (col/100mL)	0.00	0.00	0.00	0.01	1.06	7.29	100.00
E. coli (col/100mL)	0.00	0.00	0.00	2.40	0.51	24.48	1.00

**Table E-11. Equation parameters for predicting detention basin effluent concentrations.**

Pollutant	A	B	C	D	E	$e_i$	DL
TSS (mg/L)	0.00	0.00	0.00	2.16	0.59	1.42	1.00
NO <sub>3</sub> <sup>-</sup> (mg/L)	0.13	0.73	0.00	0.00	0.00		0.10
TKN (mg/L)	0.32	0.68	0.00	0.00	0.00		0.02
TN (mg/L)	<-- TN = TKN + NO3 -->						
DP (mg/L)	0.00	1.00	0.00	0.00	0.00		0.02
TP (mg/L)	0.41	0.00	0.14	0.00	0.00		0.02
TCu (ug/L)	0.00	0.00	0.00	0.94	0.84	1.10	0.10
TPb (ug/L)	0.60	0.36	0.00	0.00	0.00		0.10
TZn (ug/L)	0.00	0.00	0.00	1.87	0.71	1.06	0.01
FC (col/100mL)	0.00	0.00	0.00	11.37	0.66	2.60	1.00
E. coli (col/100mL)	0.00	0.00	0.00	2.84	0.65	2.89	1.00

**Table E-12. Equation parameters for predicting swale effluent concentrations.**

Pollutant	A	B	C	D	E	$e_i$	DL
TSS (mg/L)	0.00	0.00	0.00	5.74	0.45	1.35	0.50
NO <sub>3</sub> <sup>-</sup> (mg/L)	0.02	1.07	0.00	0.00	0.00		0.10
TKN (mg/L)	0.00	1.00	0.00	0.00	0.00		0.10
TN (mg/L)	<-- TN = TKN + NO3 -->						
DP (mg/L)	-0.01	1.41	0.00	0.00	0.00		0.02
TP (mg/L)	0.44	0.00	0.12	0.00	0.00		0.01
TCu (ug/L)	0.00	0.00	0.00	0.85	0.88	0.92	6.00
TPb (ug/L)	0.00	0.00	0.00	0.66	0.92	0.87	3.00
TZn (ug/L)	0.00	0.00	0.00	2.99	0.56	1.21	0.01
FC (col/100mL)	0.00	1.00	0.00	0.00	0.00		1000.00
E. coli (col/100mL)	0.00	1.00	0.00	0.00	0.00		0.00

**Table E-13. Equation parameters for predicting sand filter effluent concentrations.**

Pollutant	A	B	C	D	E	$e_i$	DL
TSS (mg/L)	0.00	0.00	0.00	1.38	0.46	1.69	0.50
NO <sub>3</sub> <sup>-</sup> (mg/L)	0.11	1.21	0.00	0.00	0.00		0.01
TKN (mg/L)	0.19	0.35	0.00	0.00	0.00		0.10
TN (mg/L)	<-- TN = TKN + NO3 -->						
DP (mg/L)	0.02	0.69	0.00	0.00	0.00		0.02
TP (mg/L)	0.20	0.00	0.05	0.00	0.00		0.00
TCu (ug/L)	0.00	0.00	0.00	1.16	0.73	1.10	0.40
TPb (ug/L)	0.20	0.11	0.00	0.00	0.00		0.12
TZn (ug/L)	0.00	0.00	0.00	2.26	0.46	1.37	0.01
FC (col/100mL)	0.00	0.00	0.00	0.89	0.87	2.85	2.00
E. coli (col/100mL)	0.00	0.00	0.00	0.89	0.87	2.85	2.00

**Table E-14. Equation parameters for predicting PFC effluent concentrations.**

Pollutant	A	B	C	D	E	$e_i$	DL
TSS (mg/L)	13.7	0	0	0	0		1
NO <sub>3</sub> <sup>-</sup> (mg/L)	0	1	0	0	0		0.04
TKN (mg/L)	1.11	0	0	0	0		0.4
TN (mg/L)	<-- TN = TKN + NO3 -->						
DP (mg/L)	0	1	0	0	0		0.02
TP (mg/L)	0.086	0	0	0	0		0.02
TCu (ug/L)	13.0	0	0	0	0		2
TPb (ug/L)	0.84	0	0	0	0		0.5
TZn (ug/L)	25.8	0	0	0	0		5
FC (col/100mL)	0	1	0	0	0		1
E. coli (col/100mL)	0	1	0	0	0		1

In addition to the 343 COOP rain gages, 40 Automated Surface Observing System (ASOS) rain gages with 5 minute rainfall data were analyzed. As described later in this section, the higher temporal resolution is needed for estimating the performance of flow-based BMPs, such as vegetated swales, where the volume treated is more of a function of the design flow rate than the available storage capacity. This analysis supplements continuous simulation modeling to provide a more complete estimate of the volume captured and volume lost for flow-based BMPs.

The conceptual framework, simulation approach, and post-simulation computations are described below.

## Conceptual Framework

Capture efficiency (or “percent capture”) is a metric that measures the percent of runoff that is captured and managed by a BMP (i.e., does not bypass or immediately overflow). Captured stormwater may be infiltrated, evapotranspired, or treated and released. Capture efficiency is typically expressed as an average capture rate over a long period, for example, average annual percent capture. Runoff volume that is not captured by a BMP is referred to as bypass or overflow and is assumed untreated. Volume reduction by a BMP can only occur when water is captured.

When evaluating capture efficiency and volume reduction, each BMP can be considered to consist of a set of storage compartments, each with a distinct volume, discharge rate, and pathway by which water discharges, i.e., surface discharge, infiltration, evapotranspiration (ET). For example, a bioretention area with raised underdrain may have storage below the underdrain that would be considered retention storage (infiltrates, rather than leaving the project location via surface discharge). Ponded water and gravitational water temporarily held in the soil pore space would be considered detention storage (leaves primarily through the underdrain via surface discharge). Similarly, water not freely draining from pore spaces (e.g., plant available water) would be considered ET storage.

Figure E-2 illustrates how ET, retention, and detention storage compartments were modeled. When storage capacity is available in a retention or detention storage compartment, then that compartment can capture additional inflow. When storage capacity is not available in either compartment, then inflowing water overflows or bypasses the system without treatment. The capture and volume reduction performance of a BMP are primarily a function of the amount of storage volume provided and the rate at which the storage drains to volume reduction pathways and surface discharge pathways.

Two classes of storage compartments were simulated: consistent drawdown compartments (such as the retention and detention storage mentioned above) and seasonally variable drawdown compartments (such as ET storage). The approach taken is to model a range of unit storage volumes and drawdown characteristics for each type of compartment separately and then to post-process the modeling results to estimate the performance of a specific BMP.

The conceptual representation of BMPs having discrete storage compartments allows for the development of a generalized hydrologic model that only requires two parameters for estimating percent capture and volume reduction:

- **Normalized storage volume**, expressed as an equivalent precipitation depth over the watershed that would produce a runoff volume equivalent to the compartment volume. For example, a 3,000 cu-ft storage volume for a watershed that is 1 acre with a runoff coefficient of 0.9 would translate to an equivalent precipitation depth of 0.92 inches [3,000 cu-ft  $\times$  12 in/ft / (1 ac  $\times$  43,560 sq-ft/ac  $\times$  0.9)]. Larger BMP sizes (storage volumes) relative to contributing area and imperviousness will provide a larger equivalent precipitation depth, which will allow them to bypass less volume (i.e., more capture).
- **Drawdown time** for consistent drawdown. For BMP storage elements with nominally consistent drawdown rates regardless of season (i.e., infiltration, filtration, orifice-controlled surface discharge), the representative drawdown time can be expressed in hours. For example, a bioretention area with a storage depth of 18 inches and an underlying design infiltration rate of 0.5 inches per hour would have a drawdown time of 36 hours (18 inches / 0.5 in/hr). Similarly, a detention basin with a 50,000 cubic foot, a 4-foot average depth, and a single 3-inch orifice will drain in approximately 60 hours (based on an orifice coefficient of 0.6). BMPs with shorter drawdown times allow for larger volume reductions and percent captures.
- **Drawdown time** for seasonally variable drawdown. For BMP storage elements with seasonally varying drawdown

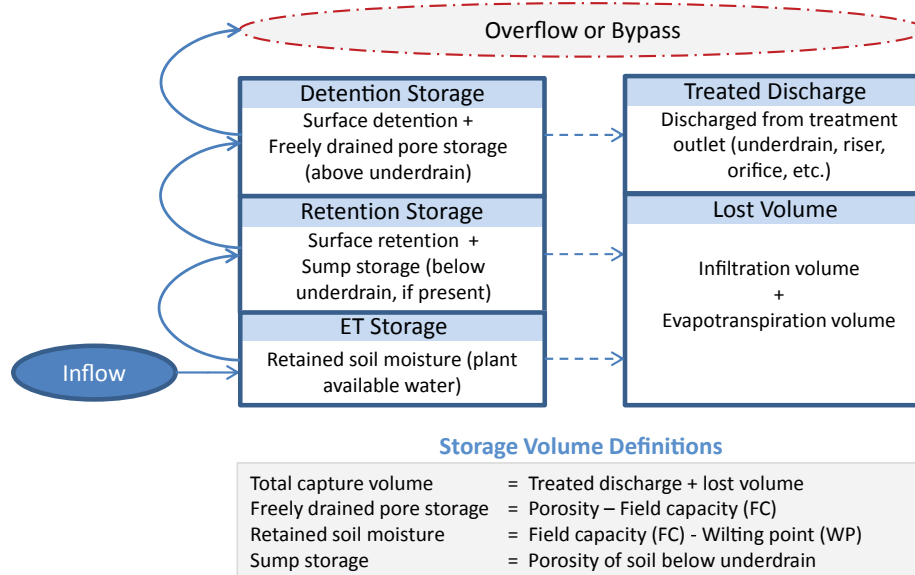

**Figure E-2. Conceptual representation of BMP storage compartments for purpose of estimating capture efficiency and volume reduction.**

## E-10

rates (i.e., storage drained by ET), the concept of a representative drawdown time is not applicable. In this case, the ET storage depth (i.e., the amount of potential ET that must occur for the ET storage to drain) is a more appropriate indicator of how quickly storage is recovered.

By isolating these two most important predictive variables, a limited number of continuous simulation model runs and associated results can be used to describe the expected long-term performance of a wide range of BMP types and configurations. For example, the results of a long term model simulation for a 0.75-inch normalized storage depth with 24 hour drawdown would be representative of a wide range of different BMP configurations. The two examples below would both be reliably represented by this single model run:

- Example 1: 20,000 cu-ft infiltration basin draining 8.2 acres of pavement (equates to 0.75-inch equivalent storm), with 3-foot ponding depth and a design infiltration rate of 1.5 inches per hour (equates to 24 hour drawdown time).
- Example 2: 300 cu-ft bioretention area with underdrains with a tributary area of 0.122 acres of pavement (equates to 0.75-inch equivalent storm), with 12 inches of ponding storage depth and a design media filtration rate of 0.5 inches per hour (equates to a 24 hour drawdown time).

### Percent Capture and Volume Reduction Estimation

An array of continuous simulation runs was executed in the EPA SWMM (version 5.0.022) to encompass the range of normalized storage volumes and drawdown times that were needed to simulate the variety of BMP types and design configurations considered for this effort. For each combination of design variables, the percent capture was calculated as:

$$\text{Percent Capture} = 100[1 - (V_{by}/V_c)] \quad (\text{Eq. 4})$$

where:

$V_{by}$  = the total volume bypassed over the simulation period  
 $V_c$  = the total runoff volume flowing into the BMP over the simulation period

Volume reduction efficiency refers to the portion of the “captured” volume that is lost to infiltration, ET, or consumptive use and does not discharge directly to surface water. Within the tool, the following assumptions have been made:

- For storage compartments without a surface discharge pathway (i.e., retention storage), the volume reduction efficiency was set to 100% (i.e., complete retention of all water that is captured).
- For storage compartments with surface discharge as well as significant volume loss pathways, the volume reduction

efficiency is estimated by computing the average loss rate as a fraction of the average total discharge rate. For example, if the average surface discharge rate during the drawdown period is 2 inches per hour and the average infiltration plus ET loss rate during that period is 0.5 inches per hour, then the volume reduction efficiency would be estimated as 20 percent ( $0.5 / (2 + 0.5)$ ).

- For storage elements with only surface discharge pathways (i.e., lined systems with limited ET), then the volume reduction efficiency is assumed to be zero. The volume estimated to be discharged from the primary treatment outlet (e.g., underdrain, riser, orifice, etc.) is assumed to be treated and having a concentration according to the estimated concentration for the particular BMP-pollutant combination.

An example percent capture nomograph is shown in Figure E-3. This is based on continuous hydrologic simulations using a 54-year hourly rainfall record (1954-2008) from the New Orleans International Airport. To use these graphs, the design volume (in watershed inches) and drawdown time (DDT) of each major storage volume must be estimated. The percent capture can then be estimated through visual interpolation.

### Number of Simulations

A large number of SWMM model runs (58,310) were completed to develop the underlying database to support the BMP Evaluation Tools. Two types of modeling scenarios were conducted.

**Consistent drawdown scenarios** were used to represent storage compartments that drawdown at a nominally constant rate throughout the year (i.e., not influenced significantly by seasonal variations in ET or use patterns). These runs can be used to represent compartments that drain to infiltration or surface discharge. Key variables include:

- Climate station
- Normalized storage volume
- Drawdown time
- Tributary area imperviousness
- Tributary area soil type

**ET drawdown scenarios** were used to represent storage compartments of BMPs that are regenerated via ET losses (i.e., are regenerated at different rates throughout the year). These runs can be used to represent the water stored in soil as well as water stored in cisterns that is applied at agronomic rates. Key variables include:

- Climate station
- Normalized storage volume
- ET drawdown depth (i.e., the amount of ET that must occur for the ET storage to drain completely)



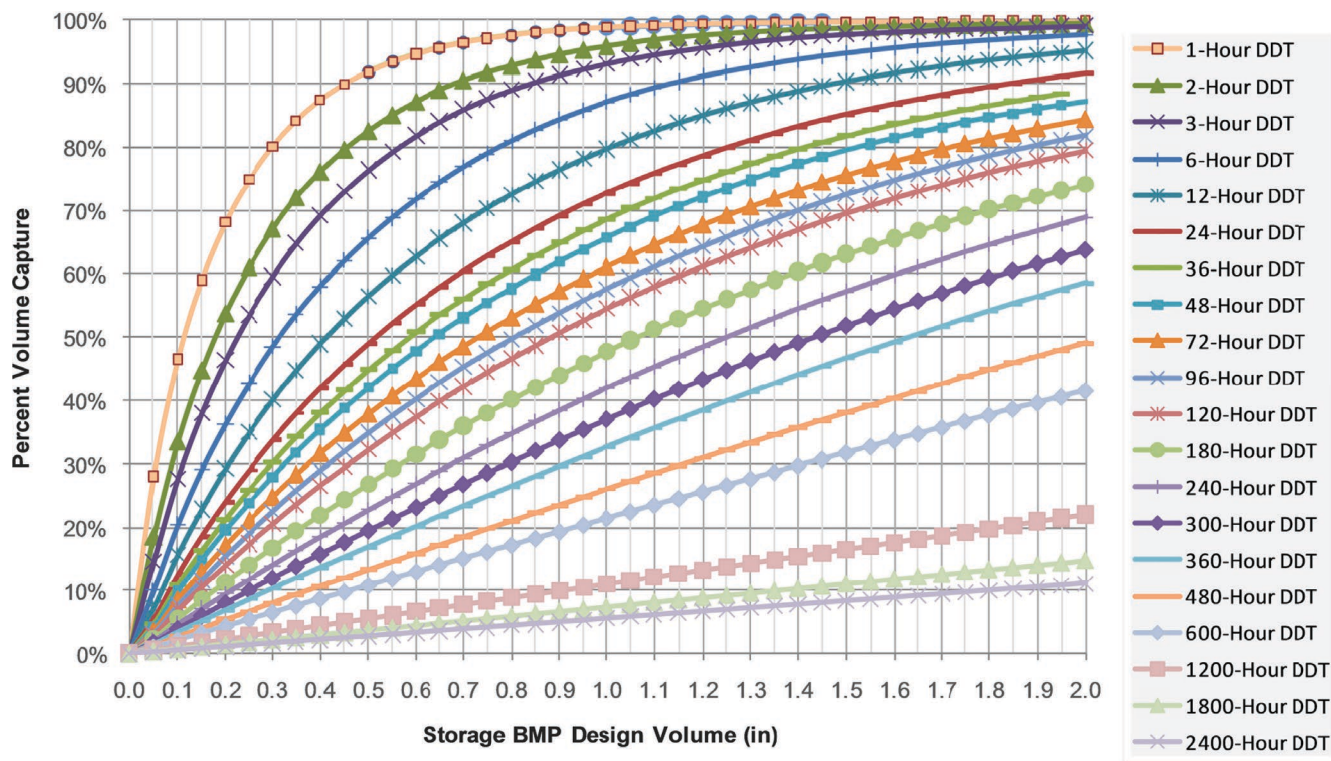

Figure E-3. Example percent capture for volume-based BMPs (New Orleans Airport).

- Tributary area imperviousness
- Tributary area soil type

Table E-15 provides a summary of the supporting model runs that were executed to provide the database to support the tool.

Key results from each SWMM run were extracted using automated routines to develop lookup databases indexed by the key parameters described in the table above.

### Rainfall Data Analysis for Flow Based BMPs

For flow-based BMPs, such as vegetated swales, estimation of percent capture differs slightly from the approach used for volume-based BMPs. For volume-based BMPs, bypass occurs when the storage volume is exceeded. For flow-based BMPs, bypass or cessation of treatment occurs when the water quality design flow rate is exceeded. With percent capture being only a function of instantaneous flow rates, nomographs can be developed simply by analyzing rainfall records and expressing design flow rates in terms of design storm intensities. The volume captured by an online, flow-based BMP can be estimated by summing all flows less than or equal to the design flow rate. This assumes that once the design flow rate is reached, treatment effectively ceases. For offline BMPs, it can be assumed that a portion of all flows up to the design

flow can be treated. Therefore, offline BMPs will tend to have a higher percent capture than online BMPs.

To account for storage routing effects associated with the time of concentration of a watershed, various averaging periods were used to aggregate the instantaneous intensities into average intensities prior to computing the volumetric percent captures.

Nomographs were created for 40 ASOS rain gages by analyzing five minute rainfall data from each gage to estimate the capture efficiency for various design intensities and times of concentration. Results are developed for both online (no treatment assumed to occur once the design flow rate exceeded) and offline BMP configurations. Each of the 343 COOP stations is assigned one of the 40 ASOS gages based on proximity.

Sample flow-based nomographs for Portland International Airport (PDX) show an online configuration (Figure E-4) and one offline configuration (Figure E-5) for a single BMP. Each data point on the nomographs reflects a percent of runoff captured by a BMP assuming a particular time of concentration and design intensity. Using the nomographs below, the required design intensity required to achieve 80% capture, assuming a 10-minute time of concentration, is approximately 0.21 in./hr for an online configuration and approximately 0.12 in./hr for an offline configuration. As shown in the figures, choosing higher design intensities and times of concentration achieves higher percent capture.

**Table E-15. Summary of supporting model runs.**

Parameter	Number of Increments
<b>Consistent Drawdown Model Runs (Infiltration, Surface Discharge)</b>	
Climate Regions	343
Modeled Imperviousness of Tributary Area	1
Supported Imperviousness	0 to 100% (analog scale; more reliable above 25%)
Modeled Soil Type	Not Applicable (100% impervious)
Supported Soil Type	User can select between 4 soil texture classes or enter a user defined soil infiltration rate within the range supported.
Storage Volume	10
Drawdown Time	10
<i>Total – Consistent Drawdown Runs</i>	<i>34,300</i>
<b>ET Drawdown Model Runs</b>	
Climate Regions	343
Modeled Imperviousness of Tributary Area	1
Supported Imperviousness	0 to 100% (analog scale; more reliable above 25%)
Modeled Soil Type	Not Applicable (100% impervious)
Supported Soil Type	User can select between 4 soil texture classes or enter a user defined soil infiltration rate within the range supported.
Storage Volume	10
ET Depth Increments	7
<i>Total – ET Runs</i>	<i>24,010</i>

**Utilizing the Percent Capture Nomographs**

The continuous simulation modeling and post-processing described in the previous sections provide the basis for estimated average annual volume captured, reduced, and treated for a wide variety of climates, BMP types, and design configurations. The specific outputs from this process are summarized in Table E-16.

The BMP Evaluation Tools query the nomograph results associated with the selected rain gage to estimate the approxi-

mate volume treated and volume reduced for a BMP given the site location and planning level information about the drainage area and BMP design. Example 5-1 summarizes the approach used by the tools to complete the computations given user input. The example computations use the example nomograph presented in Figure E-6.

Example 5-1 illustrates the process used by the BMP Evaluation Tools to estimate percent capture and percent volume loss using linear interpolation of the nomograph data. The BMP design volumes are stored as unitless values that have been

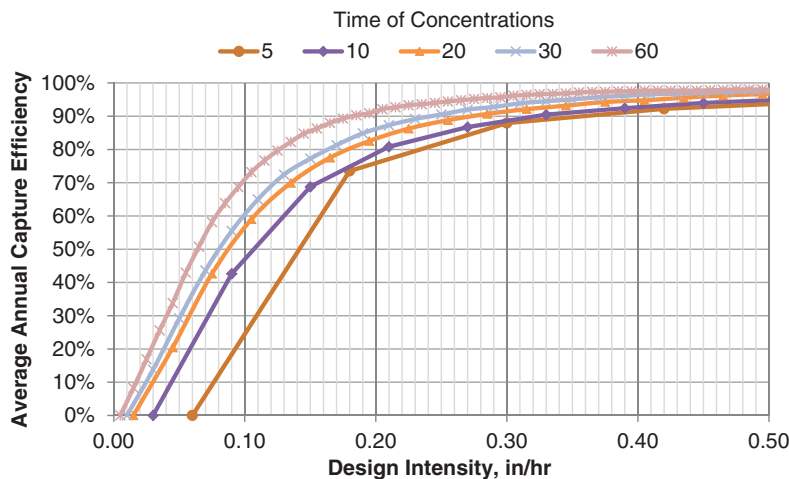

**Figure E-4. Example flow-based nomograph—online configuration (Portland International Airport).**

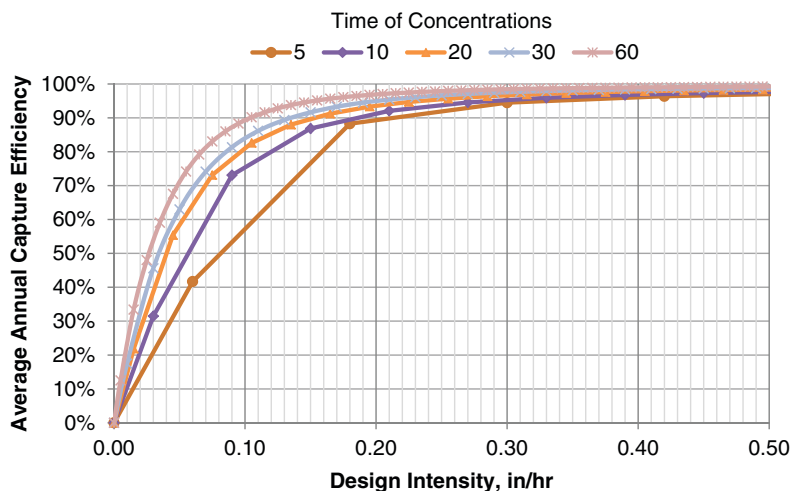

Figure E-5. Example flow-based nomograph—offline configuration (Portland International Airport).

normalized by the 85th percentile, discrete storm event for the selected rain gage. These normalized values can be used to scale the nomographs for the selected rain gage to a particular location.

### Load Reduction Estimation

Runoff loads and load reductions are computed by the BMP Evaluation Tools in a sequence of steps based on a mass balance approach as indicated in Figure E-7.

Runoff loads are estimated as the product of the average annual runoff volume ( $V_w$ ) and the characteristic runoff con-

centration ( $C_w$ ). The total estimated percent capture is used to determine the load bypassed ( $V_{by}C_w$ ) and influent load ( $V_{inf}C_w$ ). Concentration reductions by the BMP are determined using the influent-effluent relationships described in Section 0 using the equation parameters for each BMP-pollutant combination shown in Tables 10 through 14. The effluent volume ( $V_{eff}$ ) is computed as the difference between in the influent volume ( $V_{inf}$ ) and volume reduction estimated from the nomographs ( $V_{rd}$ ). The effluent load is then the product of the effluent volume and estimated effluent concentration ( $C_{eff}$ ). The combined discharge load and the load reductions are simply computed by applying a mass balance of the other terms.

Table E-16. Hydrologic analysis outputs used in calculating site-specific annual load reductions.

Information Provided for Load Reduction Estimation	Source of Information
Average annual rainfall volume	Determined from analysis of rainfall record associated with the rain gage selected by user (or may be entered directly by the user)
Runoff volume from tributary area	<ul style="list-style-type: none"> <li>Calculated using tributary area (user input), imperviousness (user input), and the average annual rainfall for the project site (based on rain gage selected, or optional user input). A volumetric runoff coefficient is computed using the following equation:                     <math display="block">R_v = a \cdot IMP + b \cdot (1 - IMP)</math>                     where <math>R_v</math> is the volumetric runoff coefficient, <math>IMP</math> is the impervious fraction, and <math>a</math> and <math>b</math> are the parameters of the equation. The defaults for <math>a</math> and <math>b</math> are 0.225 and 0.129 when <math>IMP &lt; 0.55</math>, and 1.14 and -0.371 when <math>IMP &gt; 0.55</math>, respectively based on Granato (2006).                 </li> </ul>
Percent capture	Determined by lookup, interpolation, and post-processing of the developed nomographs.
Volume reduction (as percent of captured water)	Determined by post-processing of continuous simulation percent capture results for retention, and ET compartments.

**Graphical operations supporting solution:**

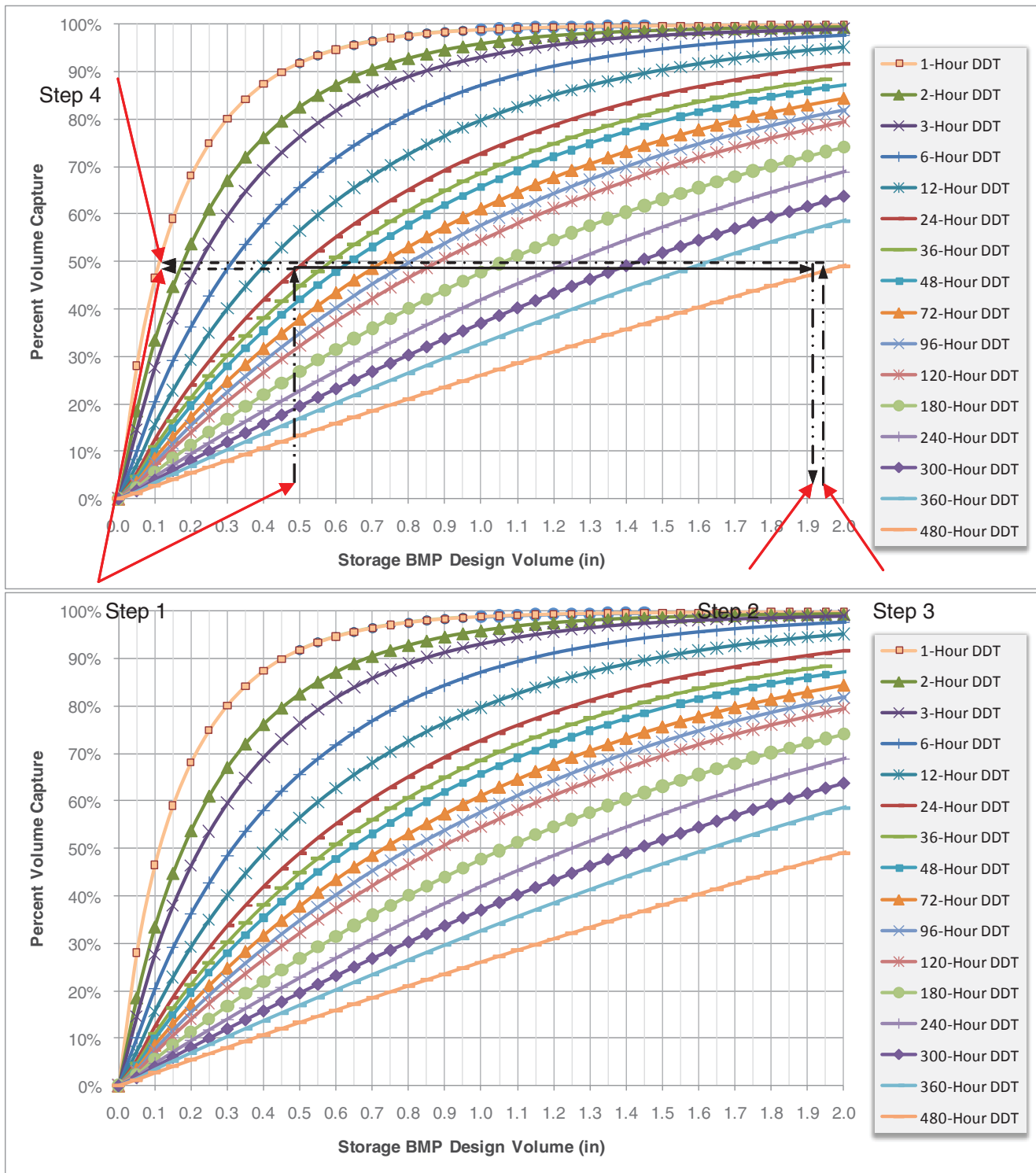

Figure E-6. Graphical operations supporting Example 5.1.



**Example 5-1: Computing Capture Efficiency for Bioretention with Underdrain****Given:**

Drainage area = 1.5 acres  
 Runoff coefficient of drainage area = 0.86 (computed)  
 Effective area of bioretention = 1000 ft<sup>2</sup>  
 Depth of bioretention media = 3 ft  
 Porosity of bioretention media = 0.4  
 Field capacity of bioretention media (fc) = 0.2  
 Wilting point of bioretention media (wp) = 0.1  
 Depth of surface ponding = 1 ft  
 Media infiltration rate = 1.5 in/hr  
 Subsurface soil infiltration rate = 0.1 in/hr  
 Average evapotranspiration rate = 0.15 in/day  
 Negligible sump storage

**Required:**

Estimate the capture efficiency and percent volume loss

**Solution:**

Since there is an underdrain and sump storage is negligible, a significant amount of the surface storage plus the freely drained pore storage will become treated discharge. The major components of the retention volume include: ( $V_1$ ) **surface retention plus freely drained pore storage** and the ( $V_2$ ) **retained soil moisture**.

Variables

$V_1$  = surface retention plus freely drained pore storage

$V_2$  = retained soil moisture

$d_1$  = surface retention plus freely drained pore storage as runoff storm depth in watershed inches

$d_2$  = retained soil moisture volume as runoff storm depth in watershed inches

$D_1$  = effective storage depth of surface retention plus freely drained pore storage

$D_2$  = effective storage depth of retained soil moisture

$DDT_1$  = brimful draw downtime of surface retention + freely drained pore storage assuming constant rate.

$DDT_2$  = brimful draw downtime of surface retention + freely drained pore storage assuming constant rate.

*Storage Volume Calculations:*

$$V_1 = (1 \text{ ft} \times 1000 \text{ ft}^2) + ((0.4-0.2) \times 3 \text{ ft} \times 1000 \text{ ft}^2) = 1,600 \text{ ft}^3$$

$$V_2 = ((0.2-0.1) \times 3 \text{ ft} \times 1000 \text{ ft}^2) = 300 \text{ ft}^3$$

*Effective Storm Depth Calculations:*

$$d_1 = (1,600 \text{ ft}^3 \times 12 \text{ in./ft}) / [0.86 \times 1.5 \text{ acres} \times 43560 \text{ ft}^2/\text{ac}] = 0.34 \text{ watershed inches}$$

$$d_2 = (300 \text{ ft}^3 \times 12 \text{ in./ft}) / [0.86 \times 1.5 \text{ acres} \times 43560 \text{ ft}^2/\text{ac}] = 0.06 \text{ watershed inches}$$

*Effective Storage Depth Calculations:*

$$D_1 = 1 \text{ ft} + ((0.4-0.2) \times 3 \text{ ft}) = 1.6 \text{ ft}$$

$$D_2 = ((0.2-0.1) \times 3 \text{ ft}) = 0.3 \text{ ft}$$

*Drawdown Time Calculations:*

$$DDT_1 = 1.6 \text{ ft} \times (12 \text{ in./ft}) / (1.5 \text{ in/hr}) = 13 \text{ hrs (controlled by media infiltration rate)}$$

$$DDT_2 = 0.3 \text{ ft} \times (12 \text{ in./ft}) \times (24 \text{ hrs/day}) / (0.15 \text{ in/day}) = 576 \text{ hrs (controlled by evapotranspiration)}$$

*Total Percent Volume Capture for  $V_1$  plus  $V_2$  using Figure E-3.*

1. For a design storm depth of 0.34 inches and a 13 hr DDT, the percent volume capture for  $V_1$  is approximately 45%.
2. Identify the design storm depth associated with 45% on the 576 hr DDT curve: ~1.8 in.
3. Add  $d_2$  to this depth: 1.8 in + 0.06 in. = 1.86 in.
4. Identify the approximate percent capture off of a 576 hr DDT curve: ~47%
5. Total volume lost = 0.06 watershed inches

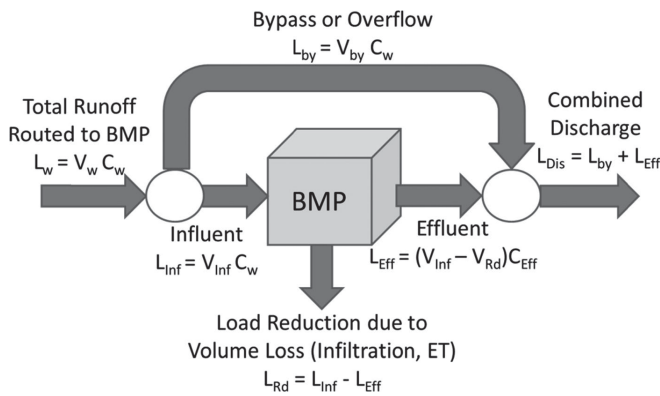

**Figure E-7. General approach for computing BMP load reductions.**

## Whole Life Cost Tool

Whole life costing (also known as life cycle cost analysis) is about identifying future costs and referring them back to present day costs using standard accounting techniques such as present value (PV). PV is defined here as “the value of a stream of benefits or costs when discounted back to the present time.”

It can be thought of as the sum of money that needs to be spent today to meet all future costs as they arise throughout the life cycle of a facility. The formula for calculating the present value is from Weiss, Gulliver, and Erickson (2007):

$$P = A \left[ \frac{\left( \frac{1+r}{1+i} \right)^n - 1}{r-i} \right]$$

where:

- P = present value of O&M (\$)
- A = average annual O&M costs (\$)
- r = annual inflation rate
- i = annual interest rate
- n = number of years

The average rate of inflation can be estimated using the CPI. Between January 1990 and January 2010 the average annual inflation rate was 3.5%. The annual interest rate can be estimated from municipal bond yield rates. The current national average return rate for “A” rated municipal bonds with a 30-year maturity is 4.0%.

The proper interest rate for DOTs is the interest rate that the Federal Reserve Bank charges on loans to institutions that borrow money from it, and it is generally very close to the interest rate that one would receive on short-term deposits ([http://www.fmsbonds.com/Market\\_Yields/index.asp](http://www.fmsbonds.com/Market_Yields/index.asp); 4% rate based on data as of 4/24/2013). In these calculations, the underlying objective is to determine how much money would have to be deposited in an interest bearing account to pay for all future capital and maintenance costs for a BMP installation. Consequently, the PV is very sensitive to the assumed interest and inflation rates and assumptions of future costs.

An important consideration is that the formula calculates present value, assuming that average annual maintenance costs are fixed for the life of the facility. This is obviously not the case unless labor and material costs are constant, which is highly unlikely. Consequently, the tool also provides a cell for the user to input the rate at which these costs rise.

The benefits from developing an accurate whole life cost include the following:

- Improved understanding of long-term investment requirements, in addition to capital costs
- More cost-effective project choices for stormwater control selection
- Explicit assessment and management of long term financial risk when integrated with a planned maintenance program
- Better understanding of the future financial liabilities when considering acceptance of the responsibility for a system.

All expenditures incurred by the DOT, whether they are termed operational or capital, result from the requirement to manage surface water runoff. Adopting a long-term approach complements the fact that most drainage assets have a relatively long useful life providing appropriate management and maintenance are performed.

There are a series of stages in the life cycle of a drainage asset. A conceptual diagram of these stages is shown in Figure E-8. These stages represent ‘cost elements’ and can be defined as:

Acquisition, which may include:

- Feasibility studies
  - Conceptual design
  - Preliminary design
  - Detailed design and development
- Construction (or purchase of a proprietary device)
- Use and maintenance
- Disposal/decommissioning.

Economies of scale can be realized as project size increases, due to the existence of significant fixed initial costs such as mobilization of staff and equipment, and travel. To provide users with a better understanding of whole life costs as they relate to bridge deck BMP incorporation, a whole life cost (WLC) tool with a standard framework was developed for each BMP. The following sections discuss the WLC methodology and tool.

## WLC Tool Calculation Foundations

The WLC tool presents an estimate of average or likely costs for an assumed set of conditions and characteristics that can be reviewed and adjusted for site-specific applications. Costs can be highly variable, and will depend, to a certain extent, on the size of the system being considered. The costs associated with BMPs incorporated for treatment of bridge deck runoff will include both capital and maintenance costs.

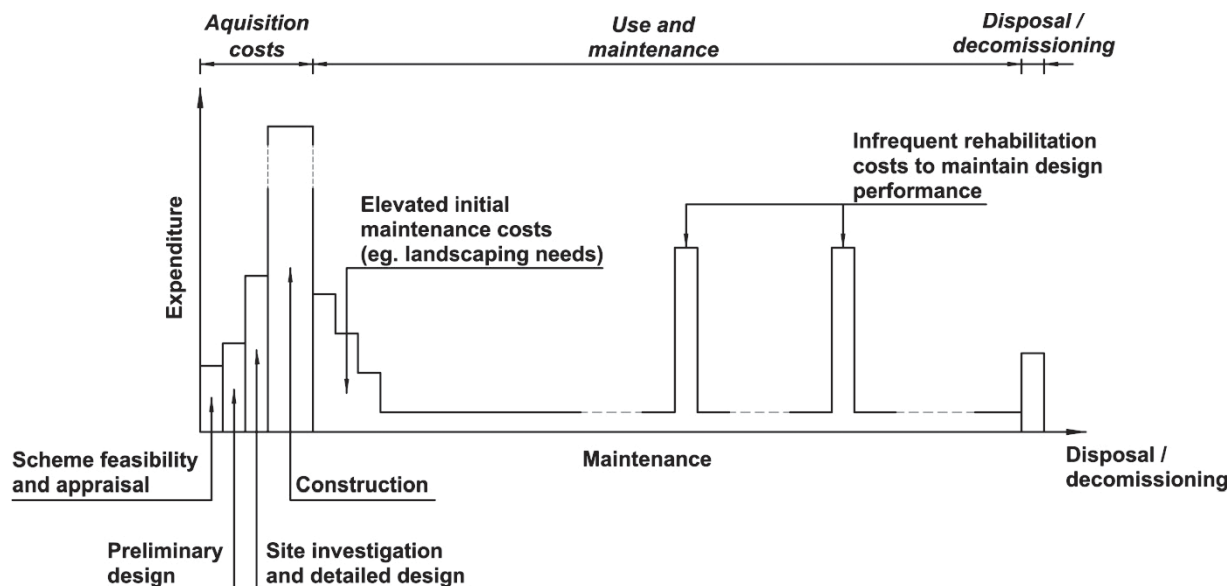

Figure E-8. Life cycle stages and associated costs (Lampe et al., 2005).

The methodology and issues in determining these costs are presented in the following sections.

### Capital Costs

Capital costs for BMPs include construction costs and various associated costs. Construction costs vary widely depending on site constraints and other factors. Most U.S. cost studies assess only part of the cost of constructing a stormwater management system, usually excluding permitting fees, engineering design and contingency or unexpected costs. In general, these costs are expressed as a fraction of the construction costs (e.g., 30%). These costs are generally only estimates, based on the experience of designers.

The cost of land varies regionally and often depends on surrounding land use. Many suburban jurisdictions require open space allocations within the developed site, reducing the effective cost of land for the control to zero for certain types of facilities. DOTs may have surplus ROW that can be used to locate a BMP. On the other hand, the cost of land, if surplus DOT ROW is not available, may far outweigh construction and design costs in dense urban settings.

Actual capital costs for controls depend on a large number of factors. Many of these factors are site-specific and thus are difficult to estimate; there are also regional cost differences. Consequently, locally derived cost estimates are more useful than generic estimates made using national data. This document provides nationally derived values for planning purposes. The following is a brief description of some major factors affecting costs:

- *Project scale and unit costs.* Stormwater controls can be built at much lower costs as part of a larger project rather than as stand-alone projects.

- *Retrofits vs. new construction.* These two scenarios exhibit very different costs, with retrofit costs being much higher and uncertain.
- *Regulatory requirements.* Each jurisdiction in the United States has varying requirements for treatment water quantity and quality volume.
- *Flexibility in site selection, site suitability.* Stormwater control cost can vary considerably due to local conditions (i.e., the need for traffic control, shoring, and availability of work area, existing infrastructure and/or site contamination).
- *Level of experience of both agency and contractors.* Some regions in the United States have required and constructed stormwater controls for over 20 years. In these areas, local contractors adapt to the market and learn the skills needed to build the controls.
- *State of the economy at the time of construction.* Another consideration is the strength of a local economy when a control is bid and built. If work is plentiful, the work may be less desirable and the cost may rise due to less competition.
- *Region.* Region may influence the design rainfall and rainfall-runoff characteristics of a site, which will in turn affect drainage system component sizing.
- *Land allocation and costs.* The cost of land is extremely variable by location, both regionally and locally depending on surrounding land use.
- *Soil type/groundwater vulnerability.* These will dictate whether infiltration methods can be used to dispose of excess runoff volumes on site, or whether additional storage and attenuation will be required.
- *Planting.* The availability of suitable plants and required level of planting planned for a particular control component will have a significant influence on costs, including irrigation and maintenance requirements.

An important consideration when assessing cost is what would be constructed in lieu of the selected practice. For instance, engineered swales are typically a much less expensive option for stormwater conveyance than the curb and gutter systems they replace, which leads to the conclusion that these water quality benefits facilities are effectively free, since some type of system is required for drainage purposes. Consequently, one should consider only the net cost attributable to the water quality component. It should be noted, however, that net costs can be difficult to generalize because the determination of what would be constructed in lieu of a practice can be very site specific.

## Maintenance Costs

Maintenance is a necessary activity required to preserve the intended water quality benefit and stormwater conveyance capacity of stormwater controls. However, there is often little planning regarding future maintenance activities and the financial and staff resources that will be needed to perform these activities. Maintenance costs, often assumed to be constant for a given type of BMP, can actually have a wide range depending on the pollutant loading rate as well as the aesthetic and safety needs of the maintenance crew and public living, driving, or working on/near them.

At many sites, vegetation management constitutes the majority of maintenance activities, rather than tasks one might expect such as sediment, debris and trash removal, or structural repair. The frequency of mowing and other vegetation management activities may have little effect on stormwater control performance, but result from the expected level of service by residents living near these facilities or by regulatory requirements. For example, tall vegetation can decrease the line of sight and dry vegetation can become a fire hazard.

The frequency of maintenance has been found to depend on the surrounding land use with more maintenance requests generated in urban areas. Consequently, the expected maintenance cost for a given type of facility can vary significantly depending on the expectations of the nearby community.

Two general maintenance categories have been established in the WLC tool: (1) routine and (2) intermittent. Routine maintenance consists of basic tasks performed on a frequent and predictable schedule. These include inspections, vegetation management, and litter and minor debris removal. In addition, three levels of routine maintenance can be identified and these relate mainly to frequency of the activity being undertaken. These are defined as:

- **Low/Minimum:** A basic level of maintenance required to maintain the function of the stormwater control.
- **Medium:** The normal level of maintenance to address function and appearance. Allows for additional activities, including preventative actions, at some facilities.

- **High:** Frequent maintenance activities performed as a result of high sediment loads, wet climate, and other factors such as safety and aesthetics.

Intermittent maintenance typically consists of corrective and infrequent maintenance activities. These are typically more resource intensive and unpredictable tasks to keep systems in working order, such as repair of structural damage and regrading eroded areas. In some cases, complete facility reconstruction may be required. The intermittent category can include a wide range of tasks that might be required to address maintenance issues at a BMP (invasive species removal, animal burrow removal, forebay cleanout, etc.).

The tool will calculate costs individually for routine BMP maintenance items while corrective and infrequent items are calculated as a generalized cost since these maintenance activities are typically unplanned. For detention basins that will be used for dual-use stormwater and spill control systems, additional cost for corrective and infrequent maintenance should be added to reflect the costs for pumping and cleanup efforts that would be incurred in the event that the basin was actually used to contain a hazardous spill. While it has not been attempted to identify possible corrective and infrequent (unplanned) maintenance activities for each BMP, the following routine (planned) maintenance activities have been identified in Table E-17.

## New vs. Retrofit Costs

In a report prepared by the URS Corporation (2012) for the NCDOT, “Stormwater Runoff from Bridges: Final Report to Joint Legislation Transportation Oversight Committee,” URS evaluates the adjustment required when estimating costs for stormwater retrofit projects for bridges compared to new construction of the same design. To provide a comparison, URS evaluated 16 NCDOT retrofit projects and determined the percent increase in cost compared to an identical new construction project.

The retrofit specific costs were project costs that would have likely been absorbed by a new construction project including mobilization, surveying, and traffic control. These retrofit-specific costs were deducted from the total retrofit cost to develop an estimated new construction cost. From these 16 retrofit projects (construction costs ranged between \$7,336 and \$246,780), the increase of cost due to retrofits was found to be 17% on average, with a range between 8 and 33% (URS Corporation 2012).

The same methodology used in the 2012 URS report to determine the percentage increase due to retrofit was applied to the Center Street and Marion Street Bridge Stormwater Retrofit project starting construction in 2013 in Salem, OR. This project’s total estimated construction cost was \$802,206



**Table E-17. BMP routine maintenance tasks.**

BMP	Routine Maintenance Task	
Swale	Remove sediment accumulation in swale bottom	Remove Trash and Debris
	Check for standing water and repair	Remove clogging if necessary
	Restore vegetative cover where required	Repair/check dams
	Mow to maintain ideal grass height	Remove invasive and woody vegetation
	Repair minor erosion/scour	Till Swale bottom
Dry Detention Basin	Remove sediment accumulation in basin	Remove Trash and Debris
	Check for embankment erosion	Check for animal burrows and repair
	Remove invasive and woody vegetation	Mow to maintain ideal grass height
	Check for standing water and repair	Check for settling of berm and repair
	Check inlets/outlets for obstructions	Restore vegetative cover where required
	Stabilize banks and channels	Check for erosion on spillway and repair rip rap
	Ensure low flow channel is clear of obstructions	
Bioretention	Remove sediment accumulation in basin	Remove Trash and Debris
	Fertilize and maintain basin vegetation	Repair minor erosion/scour
	Check for standing water and repair	Check inlets/outlets for obstructions
	Add mulch if necessary	Remove invasive and woody vegetation
Sand Filter	Remove sediment buildup in filter bed	Remove trash and debris
	Check for leaks and noticeable odors	Inspect condition of structural components
	Remove invasive and woody vegetation	Check for standing water and repair
	Check inlets/outlets for obstructions	
Bridge Scupper	Clean trash and debris	Clean sediment
	Visual inspection of damage and repair	
Open Graded Friction Course Overlay	High pressure air/water or vehicles to unclog pores	Check for localized dams within the overlay course
Pontoons, Tanks, Vaults	Remove sediment accumulation	Check inlets and outlets for obstructions
Pipes	Check for obstructions/sediment and flush	Check for leaks and repair
	Check fittings and connections and repair	Check for pipe settling and repair
Berms and Baffles	Check for damage or misplacement	Replace (baffles) or repair (berms) when required
Skimmers and Booms	Check for damage or misplacement	Replace or repair skimmer when required
	Replace absorbent boom when capacity is reached	
Valve Controls	Remove sediment	Remove trash and debris
	Inspect all components	Lubricate as required
	Check for leaks	Test operation
Liners	Visual inspection for holes and other irregularities	Inspect backfill for settling
	Check for potential animal/vegetation damage	Check anchors and seams if applicable
RTCs	Remove sediment/debris from sensors or valve	Remove trash and debris
	Replace small parts	Repair valves/other equipment
	Inspect all components	Web/monitoring services
	Troubleshooting	

and the stormwater retrofit-specific costs were estimated to be \$102,040, resulting in a 13% increase from the estimated new construction cost due to the project being built as a retrofit. This lower percent difference from the average found in the URS report is likely due to the fact that this is a much larger retrofit project compared to the 16 projects evaluated for the URS report, with corresponding lower unit prices.

In general, retrofits have higher costs associated with them because retrofit projects are usually smaller, and unit prices are typically higher for smaller material quantities. Additionally, design costs for retrofits were estimated at 150% of new construction costs, primarily because retrofits are designed as separate, individual projects including its own site visits, surveying, utility locates, and bidding process. Retrofits can also have unforeseen costs such as difficult site drainage or other difficulties that may not be encountered with a new construction project (URS Corporation 2012).

From evaluation of the URS report and application of the report methodology to a recent bridge stormwater retrofit project, it appears that 10 to 30% of the new construction cost is a reasonable range to represent the additional costs attributed specifically to stormwater retrofit projects for bridges.

**RTC Capital and Annual Maintenance Costs**

Typical stormwater BMPs and BMP components are common, and capital costs should be easily identifiable in the event they are needed for inclusion in the WLC tool and are not already listed. The exception to this is the potential future use of real time controls (RTCs), which is an uncommon, new technology for bridge deck runoff mitigation with variable capital and maintenance costs (Table E-18).

**BMP Life-Cycle vs. Bridge Life-Cycle**

The life-cycle for pipes and conveyance systems is generally much shorter than that of the typical bridge structure itself. Although the difference may vary with the selection of materials and systems used, the life span for such systems is typically about 25 years to replace the whole system versus an over 50-year bridge life. Therefore, implementation of BMPs for bridge deck runoff mitigation should consider future retrofit and/or replacement issues. Whole life costs provided in the tool are for the BMPs themselves and do not consider future replacement requirements.

**WLC Tool Calculator Guide**

The WLC tool consists of a series of Excel spreadsheets for a variety of stormwater treatment practices that are integrated into the BMP Evaluation Tool. The development of these spreadsheets was initially supported by the Water Environment Research Foundation and described by Lampe et al. (2005) and Pomeroy (2009). The spreadsheets have been revised for this project by including DOT specific values for many of the required fields.

The tool provides a framework for the calculation of capital and long-term maintenance costs associated with individual BMPs based on national averages. Local data can be used to adjust the estimates by the user. Multi-system and regional solutions will generally be built up from a number of different components, from source control to site and regional control facilities. Several spreadsheets may then be required, and costs will be built up by adding together outputs. Care should be taken to include all—but not duplicate any—relevant costs between individual BMP spreadsheets. Costs for improvements that would have otherwise been required for an operational

**Table E-18. RTC capital and annual maintenance costs.**

RTC Cost		Description	Estimated Average Cost
Capital	Design, Fabrication, and Procurement	Modeling, sizing, fabricating and testing the system	\$9,000
	Coordination and Installation	Installation at the site and testing	\$8,500
	Equipment	Valves, sensors, controller enclosures, and other components such as conduits and piping	\$7,000
Operation and Maintenance (annual)	Web / Monitoring Services	Monitoring real time data and controls	\$8,000
	Misc. Maintenance	Clean accumulated debris, inspect components, etc.	\$7,000
	Troubleshooting	Internet connectivity, system logic, power issues, etc.	\$2,000

facility had the BMP not been built should also be computed and subtracted as appropriate from the final BMP WLC.

Costs are calculated using unit prices developed from DOT bid tabulations that reflect average values of costs, RS Means 100. This option is a “first cut” for cost analysis and should be used cautiously and as a starting point. Users are encouraged to substitute local values, where known, so that the estimates more accurately reflect actual site conditions.

Basic cost dynamics are made apparent by this application, such as the relative importance of capital cost versus maintenance costs for different BMPs. In addition, the tool provides estimates of the annual outlay, so agencies responsible for maintenance will be able to estimate future resource needs and maintain these facilities in proper working order.

For practitioners who are using the tool to compare BMPs, many of the potential problematic assumptions or errors will cancel. Consequently, the best use of the cost tool is to compare the WLC of various options rather than to compute explicit costs and values for capital or O&M budget purposes. Using this approach, various practices can be easily compared to determine the most cost effective option for improving stormwater runoff quality.

Each spreadsheet tool includes several sheets for the user to input information on the design, capital costs, and maintenance costs. The content of the sheets is described in Table E-19.

### Whole Life Cost Tool Inputs

The model user will likely want to start with a basic, default scenario and then build in user entered, site-specific information as available. Again, given the significant differences in system design requirements and regional cost variables (e.g., labor costs, frequency of maintenance due to variation in climate, etc.), it is difficult to generalize for the entire United States using default values. When parametric equations are used to drive capital cost estimates, the regions of the original cost data are listed in each tool’s respective “design and cost information” sheets.

The user can also enter custom values for virtually every component tracked by the spreadsheet: system design and sizing, capital costs, and maintenance costs. This option best reflects costs for a given geographical area and site conditions. The user can employ a combination of default and user entered values as desired.

Site-specific costs and characteristics should be entered into the spreadsheet wherever available. As an example, all references to RS Means costs assume the RS Means 100 cost. RS Means 100 is a representation of cost based on the historical national average of construction costs that can be adjusted to a specific location and time by multiplying the RS Means 100 cost by location and time factors. A first step

**Table E-19. Data entry requirements of each spreadsheet section.**

Sheet Title	Spreadsheet Description
<b>Project Options</b>	Requires inputs needed for the parametric cost estimations and WLC calculations. For example the Bioretention Tool required input include: <ul style="list-style-type: none"> <li>• Local RS Means scaling factor to adjust for regional cost differences</li> <li>• Expected level of maintenance (H, M, L)</li> <li>• Design Life (years)</li> <li>• Discount rate (used in the WLC computation)</li> <li>• Inflation rate for labor and materials</li> <li>• Sales tax</li> <li>• User option to display capital and maintenance cost inputs, which are hidden by default</li> </ul> All of these inputs are essential user-entry. Model default values are available for all cells, but should be overridden with site-specific data wherever possible.
<b>Capital Costs</b>	Display this sheet by selecting “yes” in the “Would you like to view/edit capital cost inputs?” on the Project Options tab. Calculates the facility base costs and associated capital costs (e.g., engineering, land, etc.), based on the design parameters provided on the Project Design tab. Default values are provided for unit costs; however, the user can also enter specific unit costs and quantities.
<b>Maintenance Costs</b>	Display this sheet by selecting “yes” in the “Would you like to view/edit maintenance cost inputs?” on the Project Options tab. Calculates the ongoing costs associated with the operation of the system. The following costs are included: <ul style="list-style-type: none"> <li>• Routine, scheduled maintenance.</li> <li>• Corrective maintenance (e.g., periodic repair).</li> <li>• Infrequent maintenance (e.g., sediment removal).</li> </ul> Users can adjust existing and create new categories.
<b>Whole Life Costs</b>	This sheet is hidden by default, but the user can open it by right clicking on any tab and selecting “unhide”. The sheet presents a time series of the costs for the system and computes the present value of these costs. These annual costs can be useful for budgeting for future maintenance requirements
<b>Whole Life Cost Summary</b>	This sheet summarizes the maintenance and capital cost inputs and provides the Present Value of Cost over time as a graph, along with Cumulative Discounted Cost and Discounted Cost Over Time.

E-22

in improving the accuracy of a user-created cost estimate would be for the user to multiply these unit costs by the appropriate location factor, adjust to the current year using a similar factor, then enter the product in the “user entered” column. As a minimum, the assumptions and costs components should be reviewed for appropriateness prior to model application in a generic mode.

Table E-20 provides an example of the Design and Maintenance Worksheet for bioretention systems. Cells shaded yellow provide fields for the model user to input site specific information for the various model parameters. In the tool, the parameters are imported automatically from the BMP performance spreadsheets. The level of maintenance is a function of sediment load and climatic conditions for the site of interest.

Table E-21 presents the worksheet used to estimate capital costs for the facility. The default Baseline Unit Costs were developed by examining DOT bid tabulations and adjusting to an RS Means value of 100. The Adjusted Unit Cost is the default baseline adjusted for the RS Means value at the project location. The quantities of each element are calculated automatically based on the size and design of the facility specified in the BMP Performance worksheets. Associated Capital Costs are calculated as a fraction of the construction cost.

Table E-22 allows the user to adjust default maintenance parameters, such as task frequency, crew size, hourly rate, and other factors. The lower portion of the worksheet is a Lookup table (currently hidden in rows 58–69) that provides the default values that depend on the expected level of maintenance.

**Table E-20. Project options worksheet.**

1	NCHRP Bioretention Evaluation Tool					
2	Project Title			Test Run		
3	Project Location			Portland, OR		
4	Company			Geosyntec Consultants		
5	PROJECT LOCATION AND CLIMATE SELECTION	PROJECT OPTIONS	TRIBUTARY AREA ATTRIBUTES	BMP PARAMETERS	RESULTS SUMMARY REPORT	WHOLE LIFE COSTS SUMMARY
6	<b>Project Options</b>					
7	<b>Key</b>					
8	User Steps		Default Data (editable)			
9	Headings and Descriptions		Guidance			
10	User Entered Data					
11						
12						
13	Step 1: View/Edit Highway Runoff Concentrations					
14	<b>Pollutant Loads</b>					
15	Would you like to view/edit the highway runoff concentrations for the project?		no			
16						
17						
18						
19						
20						
21						
22						
23						
24						
25						
26						
27						
28						
29						
30						
31	Step 2: Select Primary Cost Inputs					
32	<b>Cost Inputs</b>		<b>Value</b>	<b>Guidance</b>		
33	Location Adjustment Factor (100 = nationwide average)		100	Enter the location scaling factor from RSMeans or other reference to adjust for local costs as a percentage of nationwide average; if not known, enter 100		
34	Expected Level of Maintenance (H = High, M = Medium, L = Low)		M	Enter the level of maintenance expected to be provided.		
35	Design Life (years)		25	Enter the design life of the BMP in years.		
36	Discount Rate (%)		5	Enter the discount rate to be used in whole lifecycle cost analysis.		
37	Inflation Rate for labor and materials (%)		3	Enter the inflation rate to be used in whole lifecycle cost analysis.		
38	Local Sales Tax (%)		9.25	Enter the local sales tax, including state and local taxes.		
39						
40	Would you like to view/edit the capital cost inputs?		no	Selecting Yes will expose the Capital Cost input tab for optional user override of default parameters.		
41	Would you like to view/edit the maintenance cost inputs?		no	Selecting Yes will expose the Maintenance Cost input tab for optional user override of default parameters.		
42						
43						
44						
45						
46						
47						
<div style="display: flex; justify-content: space-between; border-top: 1px solid black; border-bottom: 1px solid black;"> <span>Project Location</span> <span style="background-color: #e0f0e0; padding: 2px;">Project Options</span> <span>Project Design</span> <span>Results Summary Report</span> <span>Supporting Data</span> <span>Whole Life Costs Summary</span> <span style="background-color: #e0f0e0; padding: 2px;">Whole Life Costs</span> <span>+</span> </div>						



Table E-21. Example capital cost worksheet.

User-Entered Engineer's Estimate Costs	Unit	Default Baseline	User-Entered	Baseline Unit Cost used in	Adjusted Unit Cost	Default Quantity	User-Entered	Quantity used in	Cost
Mobilization	LS	\$2,455		\$2,455	\$2,455	1		1	\$2,455
Clearing & Grubbing	SY	\$1		\$1	\$1	179		179	\$171
Planting Media	CY	\$43		\$43	\$43	80		80	\$3,442
Pea Gravel	CY	\$129		\$129	\$129	10		10	\$1,290
Gravel	CY	\$27		\$27	\$27	60		60	\$1,620
Mulch	CY	\$71		\$71	\$71	10		10	\$715
Slotted PVC Underdrain Pipe	LF	\$8		\$8	\$8	66		66	\$513
Excavation/Grading	CY	\$18		\$18	\$18	313		313	\$5,678
Haul/Dispose of Excavated Material	CY	\$10		\$10	\$10	313		313	\$3,222
Finish Grading (SY):	SY	\$2		\$2	\$2	179		179	\$354
Bioretention Vegetation (SF)	SF	\$2		\$2	\$2	1,080		1,080	\$2,445
Hydroseed (SF):	SF	\$0		\$0	\$0	1,080		1,080	\$85
18" Square Trench (LF)	LF	\$1		\$1	\$1	66		66	\$52
Dewatering	DAY	\$1,200		\$1,200	\$1,200	0		0	\$0
Inflow Structure(s)	LS	\$2,200		\$2,200	\$2,200	1		1	\$2,200
Overflow Structure (concrete or rock riprap)	CY	\$125		\$125	\$125	7		7	\$875
Metal Beam Guard Rail	LF	\$58		\$58	\$58	33		33	\$1,890
Conveyance	LF			\$0	\$0			0	\$0
Other				\$0	\$0			0	\$0
Other				\$0	\$0			0	\$0
Other				\$0	\$0			0	\$0
Other				\$0	\$0			0	\$0
Other				\$0	\$0			0	\$0
Other				\$0	\$0			0	\$0
<b>Total Facility Base Cost</b>									<b>\$27,006</b>
Associated Capital Costs	Default Baseline	User-Entered	Baseline Unit Cost	Default Quantity	User-Entered	Quantity used in	Cost	Guidance	
Project Management	\$1,350		\$1,350	1		1	\$1,350	Enter project-specific values in the blue "User Entered Data" cells if applicable and the calculations will automatically update to override the default value. If a value is not provided, the default value will be used in the cost calculations.	
Engineering: Preliminary	\$2,701		\$2,701	1		1	\$2,701		
Engineering: Final Design	\$1,350		\$1,350	1		1	\$1,350		
Topographic Survey	\$675		\$675	1		1	\$675		
Geotechnical			\$0	1		1	\$0		
Landscape Design	\$540		\$540	1		1	\$540		
Land Acquisition (site, easements, etc.)			\$0			0	\$0		
Utility Relocation			\$0	1		1	\$0		
Legal Services	\$270		\$270	1		1	\$270		
Permitting & Construction Inspection	\$270		\$270	1		1	\$270		
Sales Tax	\$0		\$0	1		1	\$0		
Contingency (e.g., 20%)	\$5,401		\$5,401	1		1	\$5,401		
<b>Total Associated Capital Costs</b>							<b>\$12,558</b>		
<b>Total Facility Cost</b>							<b>\$39,563</b>		

Table E-22. Example maintenance worksheet.

ROUTINE MAINTENANCE ACTIVITIES (Frequent, scheduled events)																					
Cost Item	Frequency (months betw. maint. events)			Hours per Event			Average Labor Crew Size			Avg. (Pro-Rated) Labor Rate/Hr. (\$)			Machinery Cost/Hour (\$)			Materials & Incidentals Cost/Event (\$)			Total cost per visit (\$)		
	Model	User	Input	Model	User	Input	Model	User	Input	Model	User	Input	Model	User	Input	Model	User	Input	Default Total	User	Total with User Overrides where entered
<b>Inspection, Reporting &amp; Information Management</b>	12		12	2		2	2		2	50		50	40		40	0		0	280		280
<b>Vegetation Management with Trash &amp; Minor Debris</b>	12		12	8		8	2		2	50		50	60		60	100		100	1,380		1,380
<b>add additional activities if necessary</b>	0		0	0		0	0		0	0		0	0		0	0		0	0		0
<b>add additional activities if necessary</b>	0		0	0		0	0		0	0		0	0		0	0		0	0		0

CORRECTIVE AND INFREQUENT MAINTENANCE ACTIVITIES (Unplanned and/or > 3 yrs. betw. events)																					
Cost Item	Frequency (months betw. maint. events)			Hours per Event			Average Labor Crew Size			Avg. (Pro-Rated) Labor Rate/Hr. (\$)			Machinery Cost/Hour (\$)			Materials & Incidentals Cost/Event (\$)			Total cost per visit (\$)		
	Model	User	Input	Model	User	Input	Model	User	Input	Model	User	Input	Model	User	Input	Model	User	Input	Default Total	User	Total with User Overrides where entered
<b>Corrective Maintenance</b>	96		96	24		24	4		4	50		50	60		60	500		500	6,740		6,740
<b>Sediment Management</b>	300		300	8		8	4		4	50		50	60		60	500		500	2,580		2,580
<b>add additional activities if necessary</b>	0		0	0		0	0		0	0		0	0		0	0		0	0		0

**Guidance**

Note: For facilities judged to require larger or smaller amounts of maintenance (due to land area, etc.), consider multiplying the Model output in Column U by a multiplier (e.g., 120%) in Column V.  
 Another quick means of adjustment would be to multiply the number of Hours per Event by a multiplier in the User Input field.

HIGH, MEDIUM, AND LOW (MINIMUM) MAINTENANCE COST TABLES																					
Cost Item	Frequency (months betw. maint. events)			Hours per Event			Average Labor Crew Size			Avg. (Pro-Rated) Labor Rate/Hr. (\$)			Machinery Cost/Hour (\$)			Materials & Incidentals Cost/Event (\$)			Total cost per visit (\$)		
	Low	Med	High	Low	Med	High	Low	Med	High	Low	Med	High	Low	Med	High	Low	Med	High	Low	Med	High
<b>ROUTINE MAINTENANCE ACTIVITIES (Frequent, scheduled)</b>																					
<b>Inspection, Reporting &amp; Information Management</b>	12	12	12	2	2	2	2.0	2.0	2.0	50.00	50.00	50.00	40	40	40	0	0	0	280	280	280
<b>Vegetation Management with Trash &amp; Minor Debris</b>	36	12	6	8	8	8	2.0	2.0	2.0	50.00	50.00	50.00	60	60	60	100	100	100	1,380	1,380	1,380
<b>add additional activities if necessary</b>																					
<b>add additional activities if necessary</b>																					
<b>CORRECTIVE AND INFREQUENT MAINTENANCE ACTIVITIES (Unplanned and/or &gt; 3 yrs. betw. events)</b>																					
<b>Corrective Maintenance</b>	144	96	48	24	24	24	4.0	4.0	4.0	50.00	50.00	50.00	60	60	60	500	500	500	6,740	6,740	6,740
<b>Sediment Management</b>	600	300	120	8	8	8	4.0	4.0	4.0	50.00	50.00	50.00	60	60	60	500	500	500	2,580	2,580	2,580
<b>add additional activities if necessary</b>																					

### WLC Tool Outputs

The WLC model summarizes the expected annual costs on the Whole Life Cost worksheet (hidden by default) as shown in Table E-23. This sheet allows the user to budget future expenditures.

The WLC Summary sheet provides the capital costs and the cost per year for maintenance activities as shown in Table E-24. It also provides the total cost discounted to present value in tabular format, as well as a graph depicting the time related expenditures as shown in Figure E-9. In addition, the model provides the cumulative WLC in graphic format, which is

Table E-23. Example whole life cost.

Whole Life Costs										
Year	Discount Factor	Cost Escalation	Capital & Assoc. Costs	Regular Maint. Costs	Base Corrective Maint.	Escalated Maint. Cost	Total Costs	Present Value of Costs	Cumulative Costs	
									Cash	Present Value
<b>Cash Sum (\$)</b>							<b>571864.78</b>	<b>170119.50</b>		
0.00	1.00		<b>20063.04</b>				20063.04	20063.04	20063.04	20063.04
1.00	0.95	1.03	0.00	<b>3120.00</b>	0.00	3213.60	3213.60	3060.57	23276.64	23123.62
2.00	0.91	1.06	0.00	3120.00	0.00	3310.01	3310.01	3002.27	26586.65	26125.89
3.00	0.86	1.09	0.00	3120.00	0.00	3409.31	3409.31	2945.09	29995.96	29070.98
4.00	0.82	1.13	0.00	3120.00	6740.00	11097.52	11097.52	9129.95	41093.48	38200.93
5.00	0.78	1.16	0.00	3120.00	0.00	3616.94	3616.94	2833.96	44710.41	41034.90
6.00	0.75	1.19	0.00	3120.00	0.00	3725.44	3725.44	2779.98	48435.86	43814.88
7.00	0.71	1.23	0.00	3120.00	0.00	3837.21	3837.21	2727.03	52273.06	46541.91
8.00	0.68	1.27	0.00	3120.00	6740.00	12490.35	12490.35	8453.96	64763.42	54995.87
9.00	0.64	1.30	0.00	3120.00	0.00	4070.89	4070.89	2624.13	68834.31	57620.01
10.00	0.61	1.34	0.00	3120.00	0.00	4193.02	4193.02	2574.15	73027.33	60194.16
11.00	0.58	1.38	0.00	3120.00	0.00	4318.81	4318.81	2525.12	77346.14	62719.28
12.00	0.56	1.43	0.00	3120.00	6740.00	14058.00	14058.00	7828.02	91404.14	70547.30
13.00	0.53	1.47	0.00	3120.00	0.00	4581.83	4581.83	2429.84	95985.96	72977.14
14.00	0.51	1.51	0.00	3120.00	0.00	4719.28	4719.28	2383.56	100705.24	75360.69
15.00	0.48	1.56	0.00	3120.00	0.00	4860.86	4860.86	2338.16	105566.10	77698.85
16.00	0.46	1.60	0.00	3120.00	6740.00	15822.41	15822.41	7248.43	121388.51	84947.28
17.00	0.44	1.65	0.00	3120.00	0.00	5156.88	5156.88	2249.93	126545.39	87197.21
18.00	0.42	1.70	0.00	3120.00	0.00	5311.59	5311.59	2207.08	131856.98	89404.28
19.00	0.40	1.75	0.00	3120.00	0.00	5470.94	5470.94	2165.04	137327.92	91569.32
20.00	0.38	1.81	0.00	3120.00	6740.00	17808.26	17808.26	6711.74	155136.18	98281.07
21.00	0.36	1.86	0.00	3120.00	0.00	5804.12	5804.12	2083.34	160940.30	100364.41
22.00	0.34	1.92	0.00	3120.00	0.00	5978.24	5978.24	2043.66	166918.54	102408.07
23.00	0.33	1.97	0.00	3120.00	0.00	6157.59	6157.59	2004.73	173076.13	104412.81
24.00	0.31	2.03	0.00	3120.00	6740.00	20043.35	20043.35	6214.80	193119.48	110627.61
25.00	0.30	2.09	0.00	3120.00	0.00	6532.59	6532.59	1929.09	199652.07	112556.70
26.00	0.28	2.16	0.00	3120.00	0.00	6728.56	6728.56	1892.35	206380.63	114449.04
27.00	0.27	2.22	0.00	3120.00	0.00	6930.42	6930.42	1856.30	213311.05	116305.34
28.00	0.26	2.29	0.00	3120.00	6740.00	22558.97	22558.97	5754.65	235870.02	122059.99
29.00	0.24	2.36	0.00	3120.00	0.00	7352.48	7352.48	1786.26	243222.51	123846.25
30.00	0.23	2.43	0.00	3120.00	0.00	7573.06	7573.06	1752.24	250795.56	125598.49
31.00	0.22	2.50	0.00	3120.00	0.00	7800.25	7800.25	1718.86	258595.82	127317.35
32.00	0.21	2.58	0.00	3120.00	6740.00	25390.32	25390.32	5328.57	283986.13	132645.91
33.00	0.20	2.65	0.00	3120.00	0.00	8275.29	8275.29	1654.00	292261.42	134299.92
34.00	0.19	2.73	0.00	3120.00	0.00	8523.54	8523.54	1622.50	300784.96	135922.41
35.00	0.18	2.81	0.00	3120.00	0.00	8779.25	8779.25	1591.59	309564.21	137514.01
36.00	0.17	2.90	0.00	3120.00	6740.00	28577.02	28577.02	4934.04	338141.24	142448.04
37.00	0.16	2.99	0.00	3120.00	0.00	9313.91	9313.91	1531.54	347455.14	143979.58
38.00	0.16	3.07	0.00	3120.00	0.00	9593.32	9593.32	1502.37	357048.47	145481.95
39.00	0.15	3.17	0.00	3120.00	0.00	9881.12	9881.12	1473.75	366929.59	146955.70
40.00	0.14	3.26	0.00	3120.00	6740.00	32163.69	32163.69	4568.71	399093.29	151524.41
41.00	0.14	3.36	0.00	3120.00	0.00	10482.88	10482.88	1418.14	409576.17	152942.55
42.00	0.13	3.46	0.00	3120.00	0.00	10797.37	10797.37	1391.13	420373.54	154333.68
43.00	0.12	3.56	0.00	3120.00	0.00	11121.29	11121.29	1364.63	431494.83	155698.31
44.00	0.12	3.67	0.00	3120.00	6740.00	36200.52	36200.52	4230.44	467695.35	159928.75
45.00	0.11	3.78	0.00	3120.00	0.00	11798.58	11798.58	1313.14	479493.93	161241.89
46.00	0.11	3.90	0.00	3120.00	0.00	12152.54	12152.54	1288.13	491646.47	162530.02
47.00	0.10	4.01	0.00	3120.00	0.00	12517.11	12517.11	1263.59	504163.58	163793.62
48.00	0.10	4.13	0.00	3120.00	6740.00	40744.00	40744.00	3917.21	544907.58	167710.83
49.00	0.09	4.26	0.00	3120.00	0.00	13279.40	13279.40	1215.91	558186.99	168926.74
50.00	0.09	4.38	1.00	3120.00	0.00	13677.79	13677.79	1192.75	571864.78	170119.50

**Table E-24. Example whole life cost summary.**

Whole Life Cycle Costs Summary			
<b>CAPITAL COSTS</b>		<b>Total Cost</b>	
Total Facility Base Cost		\$12,882	
Total Associated Capital Costs (e.g., Engineering, Land, etc.)		\$7,181	
Capital Costs		\$20,063	
<b>REGULAR MAINTENANCE ACTIVITIES</b>		<b>Years between Events</b>	<b>Total Cost per Visit</b>
Inspection, Reporting & Information Management		0.5	\$180
Vegetation Management with Trash & Minor Debris Removal		0.5	\$1,380
add additional activities if necessary		0	\$0
add additional activities if necessary		0	\$0
Totals, Regular Maintenance Activities			\$3,120
<b>CORRECTIVE AND INFREQUENT MAINTENANCE ACTIVITIES (Unplanned and/or &gt;3yrs. betw. events)</b>		<b>Years between Events</b>	<b>Total Cost per Visit</b>
Corrective Maintenance		4	\$6,740
add additional activities if necessary		0	\$0
add additional activities if necessary		0	\$0
Totals, Corrective & Infrequent Maintenance Activities			\$1,685
<b>Capital Costing Method</b>		Line Item Engineer's Estimate	
Assumed Level of Maintenance		H	
Estimated Capital Cost, \$ (2013)		\$20,063	
Estimated NPV of Design Life Maintenance Costs, \$ (2013)		\$92,494	
Estimated NPV of Design Life Whole Life Cycle Cost, \$ (2013)		\$112,557	
Estimated Annualized Whole Life Cycle Cost, \$/yr (2013)		\$4,502	
Totals are based on design life with routine and major maintenance.			

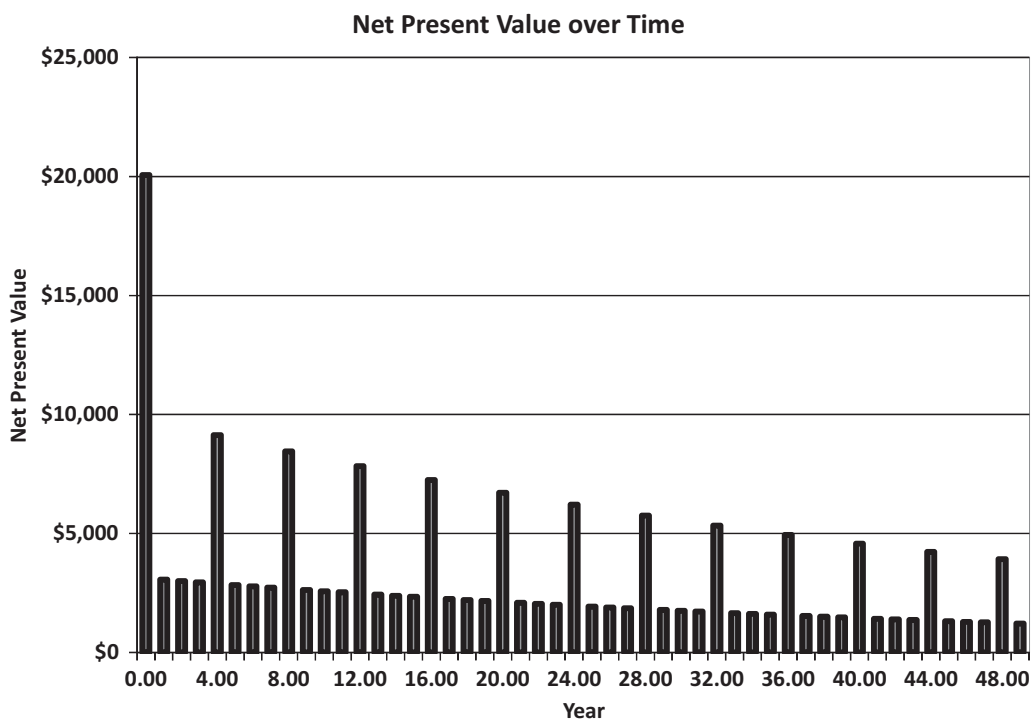

**Figure E-9. Example present value of costs graph.**



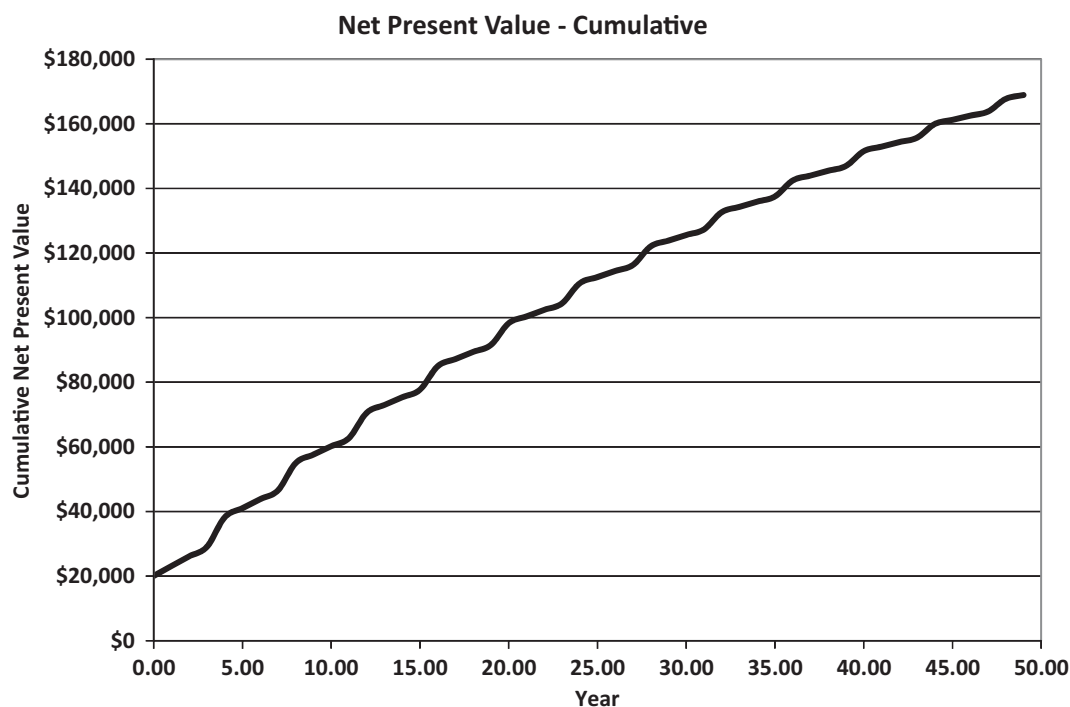

**Figure E-10. Example cumulative discounted costs graph.**

shown in Figure E-10. The WLC for a variety of BMPs can then be calculated and compared to determine the least cost alternative for a given scenario.

## References

- Efron, B. and Tibishirani, R. (1993). *An Introduction to the Bootstrap*. Chapman & Hall, New York.
- Geosyntec and Wright Water Engineers (WWE) (2012). *International Stormwater Best Management Practices (BMP) Database Pollutant Category Summary Statistical Addendum: TSS, Bacteria, Nutrients, and Metals*. Prepared for the Water Environment Research Foundation. <http://www.bmpdatabase.org/performance-summaries.html>.
- Granato, G. E. (2006). Kendall-Theil Robust Line (KTRLine—version 1.0)—A Visual Basic Program for Calculating and Graphing Robust Nonparametric Estimates of Linear-Regression Coefficients Between Two Continuous Variables, Techniques and Methods of the US Geological Survey, Book 4, Chap. A7, 31 p. <http://pubs.usgs.gov/tm/2006/tm4a7/>
- Granato, G. E., and P. A. Cazenias (2009). Highway-Runoff Database (HRDB Version 1.0)—A Data Warehouse and Preprocessor for the Stochastic Empirical Loading and Dilution Model, Washington, D.C., U.S. Department of Transportation, Federal Highway Administration, FHWA-HEP-09-004, <http://webdamr1.er.usgs.gov/g1/FHWA/SELDM.htm>
- Helsel, D. R. and Cohn, T. A. (1988). Estimation of Descriptive Statistics for Multiply Censored Water Quality Data. *Wat. Res. Research*, 24(12): 1997-2004.
- Helsel, D. R. and Hirsch, R. M. (2002). *Statistical Methods in Water Resources*. U.S. Geological Survey, Techniques of Water-Resources Investigations Book 4, Chapter A3. Water Resources Division, USGS. Reston, VA.
- Lampe, Barrett, et al. (2005). *Performance and Whole Life Costs of Best Management Practices and Sustainable Urban Drainage Systems*, Project 01-CTS-21Ta. Alexandria, VA: Water Environment Research Foundation.
- Pitt, R. (2008). *National Stormwater Quality Database (NSQD) Version 3 Spreadsheet*. [Accessed 4/25/2013] <http://rpitt.eng.ua.edu/Research/ms4/mainms4.shtml>
- Smith, K. P., and Granato, G. E. (2010). *Quality of Stormwater Runoff Discharged from Massachusetts Highways, 2005–07*, US Geological Survey Scientific Investigations Report 2009–5269. <http://pubs.usgs.gov/sir/2009/5269/>
- URS Corporation (2012). *Stormwater Runoff from Bridges: Final Report to Joint Legislation Transportation Oversight Committee*. Prepared for NC Department of Transportation (NCDOT), May.
- Weiss, P. T., Gulliver, J. S., and Erickson, A. J. (2007). Cost and Pollutant Removal of Storm-Water Treatment Practices. *Journal of Water Resources Planning and Management*.

*Abbreviations and acronyms used without definitions in TRB publications:*

A4A	Airlines for America
AAAAE	American Association of Airport Executives
AASHO	American Association of State Highway Officials
AASHTO	American Association of State Highway and Transportation Officials
ACI-NA	Airports Council International-North America
ACRP	Airport Cooperative Research Program
ADA	Americans with Disabilities Act
APTA	American Public Transportation Association
ASCE	American Society of Civil Engineers
ASME	American Society of Mechanical Engineers
ASTM	American Society for Testing and Materials
ATA	American Trucking Associations
CTAA	Community Transportation Association of America
CTBSSP	Commercial Truck and Bus Safety Synthesis Program
DHS	Department of Homeland Security
DOE	Department of Energy
EPA	Environmental Protection Agency
FAA	Federal Aviation Administration
FHWA	Federal Highway Administration
FMCSA	Federal Motor Carrier Safety Administration
FRA	Federal Railroad Administration
FTA	Federal Transit Administration
HMCRP	Hazardous Materials Cooperative Research Program
IEEE	Institute of Electrical and Electronics Engineers
ISTEA	Intermodal Surface Transportation Efficiency Act of 1991
ITE	Institute of Transportation Engineers
MAP-21	Moving Ahead for Progress in the 21st Century Act (2012)
NASA	National Aeronautics and Space Administration
NASAO	National Association of State Aviation Officials
NCFRP	National Cooperative Freight Research Program
NCHRP	National Cooperative Highway Research Program
NHTSA	National Highway Traffic Safety Administration
NTSB	National Transportation Safety Board
PHMSA	Pipeline and Hazardous Materials Safety Administration
RITA	Research and Innovative Technology Administration
SAE	Society of Automotive Engineers
SAFETEA-LU	Safe, Accountable, Flexible, Efficient Transportation Equity Act: A Legacy for Users (2005)
TCRP	Transit Cooperative Research Program
TEA-21	Transportation Equity Act for the 21st Century (1998)
TRB	Transportation Research Board
TSA	Transportation Security Administration
U.S.DOT	United States Department of Transportation