

Best Practices for Crack Treatments for Asphalt Pavements

DETAILS

37 pages | 8.5 x 11 | PAPERBACK

ISBN 978-0-309-30793-2 | DOI 10.17226/22314

AUTHORS

Dale S. Decker

BUY THIS BOOK

FIND RELATED TITLES

Visit the National Academies Press at NAP.edu and login or register to get:

- Access to free PDF downloads of thousands of scientific reports
- 10% off the price of print titles
- Email or social media notifications of new titles related to your interests
- Special offers and discounts



Distribution, posting, or copying of this PDF is strictly prohibited without written permission of the National Academies Press. (Request Permission) Unless otherwise indicated, all materials in this PDF are copyrighted by the National Academy of Sciences.

NATIONAL COOPERATIVE HIGHWAY RESEARCH PROGRAM

NCHRP REPORT 784

**Best Practices
for Crack Treatments
for Asphalt Pavements**

Dale S. Decker
DALE S. DECKER, LLC
Eagle, CO

Subscriber Categories

Construction • Maintenance and Preservation • Materials

Research sponsored by the American Association of State Highway and Transportation Officials
in cooperation with the Federal Highway Administration

TRANSPORTATION RESEARCH BOARD

WASHINGTON, D.C.
2014
www.TRB.org

NATIONAL COOPERATIVE HIGHWAY RESEARCH PROGRAM

Systematic, well-designed research provides the most effective approach to the solution of many problems facing highway administrators and engineers. Often, highway problems are of local interest and can best be studied by highway departments individually or in cooperation with their state universities and others. However, the accelerating growth of highway transportation develops increasingly complex problems of wide interest to highway authorities. These problems are best studied through a coordinated program of cooperative research.

In recognition of these needs, the highway administrators of the American Association of State Highway and Transportation Officials initiated in 1962 an objective national highway research program employing modern scientific techniques. This program is supported on a continuing basis by funds from participating member states of the Association and it receives the full cooperation and support of the Federal Highway Administration, United States Department of Transportation.

The Transportation Research Board of the National Academies was requested by the Association to administer the research program because of the Board's recognized objectivity and understanding of modern research practices. The Board is uniquely suited for this purpose as it maintains an extensive committee structure from which authorities on any highway transportation subject may be drawn; it possesses avenues of communications and cooperation with federal, state and local governmental agencies, universities, and industry; its relationship to the National Research Council is an insurance of objectivity; it maintains a full-time research correlation staff of specialists in highway transportation matters to bring the findings of research directly to those who are in a position to use them.

The program is developed on the basis of research needs identified by chief administrators of the highway and transportation departments and by committees of AASHTO. Each year, specific areas of research needs to be included in the program are proposed to the National Research Council and the Board by the American Association of State Highway and Transportation Officials. Research projects to fulfill these needs are defined by the Board, and qualified research agencies are selected from those that have submitted proposals. Administration and surveillance of research contracts are the responsibilities of the National Research Council and the Transportation Research Board.

The needs for highway research are many, and the National Cooperative Highway Research Program can make significant contributions to the solution of highway transportation problems of mutual concern to many responsible groups. The program, however, is intended to complement rather than to substitute for or duplicate other highway research programs.

NCHRP REPORT 784

Project 20-07
ISSN 0077-5614
ISBN 978-0-309-30793-2
Library of Congress Control Number 2014946941

© 2014 National Academy of Sciences. All rights reserved.

COPYRIGHT INFORMATION

Authors herein are responsible for the authenticity of their materials and for obtaining written permissions from publishers or persons who own the copyright to any previously published or copyrighted material used herein.

Cooperative Research Programs (CRP) grants permission to reproduce material in this publication for classroom and not-for-profit purposes. Permission is given with the understanding that none of the material will be used to imply TRB, AASHTO, FAA, FHWA, FMCSA, FTA, or Transit Development Corporation endorsement of a particular product, method, or practice. It is expected that those reproducing the material in this document for educational and not-for-profit uses will give appropriate acknowledgment of the source of any reprinted or reproduced material. For other uses of the material, request permission from CRP.

NOTICE

The project that is the subject of this report was a part of the National Cooperative Highway Research Program, conducted by the Transportation Research Board with the approval of the Governing Board of the National Research Council.

The members of the technical panel selected to monitor this project and to review this report were chosen for their special competencies and with regard for appropriate balance. The report was reviewed by the technical panel and accepted for publication according to procedures established and overseen by the Transportation Research Board and approved by the Governing Board of the National Research Council.

The opinions and conclusions expressed or implied in this report are those of the researchers who performed the research and are not necessarily those of the Transportation Research Board, the National Research Council, or the program sponsors.

The Transportation Research Board of the National Academies, the National Research Council, and the sponsors of the National Cooperative Highway Research Program do not endorse products or manufacturers. Trade or manufacturers' names appear herein solely because they are considered essential to the object of the report.

Published reports of the

NATIONAL COOPERATIVE HIGHWAY RESEARCH PROGRAM

are available from:

Transportation Research Board
Business Office
500 Fifth Street, NW
Washington, DC 20001

and can be ordered through the Internet at:

<http://www.national-academies.org/trb/bookstore>

Printed in the United States of America

THE NATIONAL ACADEMIES

Advisers to the Nation on Science, Engineering, and Medicine

The **National Academy of Sciences** is a private, nonprofit, self-perpetuating society of distinguished scholars engaged in scientific and engineering research, dedicated to the furtherance of science and technology and to their use for the general welfare. Upon the authority of the charter granted to it by the Congress in 1863, the Academy has a mandate that requires it to advise the federal government on scientific and technical matters. Dr. Ralph J. Cicerone is president of the National Academy of Sciences.

The **National Academy of Engineering** was established in 1964, under the charter of the National Academy of Sciences, as a parallel organization of outstanding engineers. It is autonomous in its administration and in the selection of its members, sharing with the National Academy of Sciences the responsibility for advising the federal government. The National Academy of Engineering also sponsors engineering programs aimed at meeting national needs, encourages education and research, and recognizes the superior achievements of engineers. Dr. C. D. Mote, Jr., is president of the National Academy of Engineering.

The **Institute of Medicine** was established in 1970 by the National Academy of Sciences to secure the services of eminent members of appropriate professions in the examination of policy matters pertaining to the health of the public. The Institute acts under the responsibility given to the National Academy of Sciences by its congressional charter to be an adviser to the federal government and, upon its own initiative, to identify issues of medical care, research, and education. Dr. Victor J. Dzau is president of the Institute of Medicine.

The **National Research Council** was organized by the National Academy of Sciences in 1916 to associate the broad community of science and technology with the Academy's purposes of furthering knowledge and advising the federal government. Functioning in accordance with general policies determined by the Academy, the Council has become the principal operating agency of both the National Academy of Sciences and the National Academy of Engineering in providing services to the government, the public, and the scientific and engineering communities. The Council is administered jointly by both Academies and the Institute of Medicine. Dr. Ralph J. Cicerone and Dr. C. D. Mote, Jr., are chair and vice chair, respectively, of the National Research Council.

The **Transportation Research Board** is one of six major divisions of the National Research Council. The mission of the Transportation Research Board is to provide leadership in transportation innovation and progress through research and information exchange, conducted within a setting that is objective, interdisciplinary, and multimodal. The Board's varied activities annually engage about 7,000 engineers, scientists, and other transportation researchers and practitioners from the public and private sectors and academia, all of whom contribute their expertise in the public interest. The program is supported by state transportation departments, federal agencies including the component administrations of the U.S. Department of Transportation, and other organizations and individuals interested in the development of transportation. **www.TRB.org**

www.national-academies.org

COOPERATIVE RESEARCH PROGRAMS

CRP STAFF FOR NCHRP REPORT 784

Christopher W. Jenks, *Director, Cooperative Research Programs*

Christopher Hedges, *Manager, National Cooperative Highway Research Program*

Edward T. Harrigan, *Senior Program Officer*

Anthony P. Avery, *Senior Program Assistant*

Eileen P. Delaney, *Director of Publications*

Scott E. Hitchcock, *Editor*

NCHRP PROJECT 20-07/TASK 339 PANEL

Area of Special Projects

James “Jim” McGraw, *Blaine, MN*

Randy K. Pace, *North Carolina DOT, Raleigh, NC*

William Real, *New Hampshire DOT, Concord, NH*

Stephen R. Mueller, *FHWA Liaison*

AUTHOR ACKNOWLEDGMENTS

The work reported herein was performed by Dale S. Decker, P.E. Special thanks go to the AASHTO Subcommittee on Maintenance members, National Association of County Engineers, International Slurry Surfacing Association members, and affiliates of Transportation Association of Canada for their assistance in the conduct of the State-of-the-Practice Survey. The staff of CrafcO is also acknowledged for their assistance, as well as Dr. Imad Al-Qadi and his pooled fund study team of the University of Illinois for assisting with review of the Sealant Grading portion of the report.

FOREWORD

By Edward T. Harrigan

Staff Officer

Transportation Research Board

This report presents best practices for crack treatments for asphalt pavements developed through a critical review of the current states of the art and practice. It will be of interest to engineers in public agencies and industry with responsibility for construction and maintenance of asphalt pavements.

Crack sealing and crack filling are widely used treatments for maintenance of asphalt pavements. However, successful crack sealing and crack filling applications continue to be viewed as an art. When not properly applied, these pavement preservation treatments can result in early failures and costly corrective maintenance for highway agencies. Although much research has been performed in the United States and abroad on the materials, techniques, and designs for crack sealing and crack filling, variability in the current state of the practice regarding construction techniques and the resulting effectiveness of crack sealing and crack filling have not been investigated.

The objective of NCHRP Project 20-07/Task 339 was to identify current best practices for crack sealing and crack filling of asphalt pavements. The research was performed by Dale S. Decker, LLC, Eagle, Colorado. The research included a critical review of the worldwide literature on crack sealing and filling, with emphasis on identifying current best practices. A survey of state, local, and provincial highway agencies was then conducted to fill gaps in the results of the literature review.

This report fully documents the research and includes chapters on the current states of the art and practice that support the chapter discussing the selected best practices.

CONTENTS

1	Summary
2	Chapter 1 Introduction
2	Purpose of This Report
3	Scope of Work
4	Chapter 2 State-of-the-Art in Crack Treatments
4	Summary of the Literature Review
4	General Issues/Project Selection
8	Contracting Procedures
8	Materials
10	Construction
12	Quality Control
12	Performance
13	Conclusion
14	Chapter 3 State-of-the-Practice in Crack Treatments
14	Summary of the Survey Results
14	General Issues/Project Selection
17	Contracting Procedures
17	Materials
18	Construction
20	Quality Control
20	Performance
21	Conclusion
22	Chapter 4 Best Practices for Crack Treatments
22	General Issues/Project Selection
23	Contracting Procedures
23	Materials
23	Construction
31	Quality Control
33	Conclusion
34	Bibliography

Note: Many of the photographs, figures, and tables in this report have been converted from color to grayscale for printing. The electronic version of the report (posted on the Web at www.trb.org) retains the color versions.

S U M M A R Y

Best Practices for Crack Treatments for Asphalt Pavements

Treating cracks in asphalt pavements is a major part of every maintenance engineer's work. The objective of any crack treatment is to minimize the intrusion of water into underlying layers of the pavement structure. Such water infiltrates the base layers of the pavement and may lead to pavement structural failures.

Crack treatments fall into two broad categories—crack sealing and crack filling. Crack sealing is generally performed on “working” cracks, e.g., cracks that are more than $\frac{1}{8}$ ” in the summer and significantly larger in the winter. However, crack sealing can be used for any crack treatment operation. Crack filling is generally performed on cracks that do not open and close due to environmental conditions.

Much research has been performed in the United States and abroad on the materials and designs for crack treatments for flexible pavements; however, little is known about variability in the current state-of-the-practice regarding construction techniques and the resulting effectiveness of crack sealing and crack filling.

This report summarizes the state-of-the-art and current state-of-the-practice of crack treatments and concludes with current best practices. This report is limited to crack sealing and crack filling of asphalt pavements, and does not consider joint filling on concrete pavements, reflective cracking retardation techniques, joint construction techniques, or other related issues.

As would be expected, the state-of-the-art and the state-of-the-practice do not directly correlate to one another. Based on the results of this project, areas in which improvements in the state-of-the-practice should be considered include:

- Evaluation of pavement condition prior to sealant application—i.e., what type of crack is present, how severe is the cracking, and what is the density of the cracking;
- Acceptance of the new Sealant Grade evaluation system;
- Proper preparation of the crack prior to sealant application—making sure that the crack is clean, dry, and properly configured for the application;
- Training for sealant application personnel—this is an ongoing need;
- Quality Control testing for sealant products—establishment of uniform sampling and testing protocols;
- Inspection of the crack treatment operations—many agencies do little if any inspection of crack treatment work; and
- Evaluation of sealant performance—understanding how the sealant performs enables owners to make knowledgeable decisions about materials and procedures.

CHAPTER 1

Introduction

Purpose of This Report

Reportedly the first asphalt pavement was built in about 1828—the National Road between Wheeling, West Virginia, and Zanesville, Ohio (73) {numbers in parentheses are references in the Bibliography of the report}. Although undocumented, it is likely that within a few years of construction of this first asphalt pavement, engineers began to discuss what to do about cracking in the pavements. Cracks are prevalent throughout the approximately 2.5 million miles of paved roads in the United States.

The National Cooperative Highway Research Program has published two previous documents on the subject of crack sealing, *NCHRP Report 38* by Cook and Lewis in 1967 (29) and *NCHRP Synthesis 98* by Peterson in 1982 (60). Crack sealing and crack filling are widely used maintenance activities for in-service pavements. The techniques are inexpensive, quick, and well-proven approaches to extend the life of the pavement, predicated on the use of the right materials at the right time using the right protocols.

Select the right preventative maintenance treatment at the right time for the right road.

—Jim Sorenson, quoted by Paul Fournier
in *Associated Construction Publications* (77)

In a memo from David Geiger in September 2005 (62), the Federal Highway Administration (FHWA) describes a Pavement Preservation program as consisting of Preventative Maintenance, Pavement Rehabilitation (structural and non-structural), and Routine Maintenance activities. The following definitions were quoted in the Geiger memo and were developed by the FHWA Pavement Preservation Expert Task Group (ETG), the AASHTO Standing Committee on

Highways, and the AASHTO Highway Subcommittee on Maintenance.

- *Pavement Preservation* is defined as “a program employing a network level, long-term strategy that enhances pavement performance by using an integrated, cost-effective set of practices that extend pavement life, improve safety and meet motorist expectations.”
- *Preventative Maintenance* is defined as “a planned strategy of cost-effective treatments to an existing roadway system and its appurtenances that preserves the system, retards future deterioration, and maintains or improves the functional condition of the system (without significantly increasing the structural capacity).”
- *Pavement Rehabilitation* is defined as structural and non-structural “enhancements that extend the service life of an existing pavement and/or improve its load carrying capacity.”
- *Routine Maintenance* “consists of work that is planned and performed on a routine basis to maintain and preserve the condition of the highway system or to respond to specific conditions and events that restore the highway system to an adequate level of service.”

FHWA published the guidelines presented in Table 1-1 for the determination of the type of maintenance to be performed (53). These guidelines establish criteria for when to use crack treatments.

FHWA categorizes crack sealing as Preventative Maintenance and crack filling as Routine Maintenance. Ponniah (34) also describes a crack sealing program as a preventative maintenance treatment, not a corrective maintenance measure, thereby agreeing with the FHWA definitions.

Chong and Phang (35) describe the consequences of not sealing cracks:

1. Increased maintenance costs, because deteriorated cracks are difficult and expensive to repair through corrective maintenance;

Table 1-1. Guidelines for determining the type of maintenance to be performed (53).

Crack Density	Average Level of Edge Deterioration (% of crack length)		
	Low (0-25)	Moderate (26-50)	High (51-100)
Low	Do Nothing	Do Nothing or Crack Treatment	Crack Repair
Moderate	Crack Treatment	Crack Treatment	Crack Repair
High	Surface Treatment	Surface Treatment	Rehabilitation

2. Increased user costs (vehicle repair and operation);
3. Increased rehabilitation costs, because deteriorated cracks demand special treatment from the designer when pavement rehabilitation is scheduled; and
4. Loss of serviceability and, therefore, service life.

Crack sealing and crack filling are widely used for preventative maintenance of asphalt pavements; however, successful crack sealing and crack filling applications continue to be perceived as an art. When not properly applied, these pavement preservation treatments can result in early failures and costly corrective maintenance for user agencies.

Scope of Work

The objective of any crack sealing or crack filling operation is to minimize the intrusion of water into underlying layers of the pavement structure. Such water intrusion weakens the base materials and may lead to structural pavement failures.

Much research has been performed in the United States and abroad on the materials and designs for crack sealing and crack filling for flexible pavements; however, little is known about variability in the current state-of-the-practice regarding construction techniques and the resulting effectiveness of crack sealing and crack filling. This report summarizes the state-of-the-art and state-of-the-practice of crack sealing and crack filling and concludes with current best practices. This report is limited to crack sealing and crack filling of asphalt pavements, and does not consider joint filling on concrete pavements, reflective cracking retardation techniques, joint construction techniques, or other related issues.

The 1967 *NCHRP Report 38* on crack sealing stated: “Crack sealing is receiving very little engineering attention. Most cracks are simply filled occasionally with a tar or an asphalt” (29). This statement is still true in some jurisdictions.

Nebraska Department of Roads Pavement Maintenance Manual (82):

“Crack filling and sealing is our first line of defense in roadway maintenance. Crack sealing should be done within 2 years after an asphalt overlay.”

“At a time when highway crew manpower is shrinking, along with the funds to support road maintenance, crack sealing stands out as an economical maintenance technique.”

The literature review for this project is summarized in Chapter 2: State-of-the-Art in Crack Treatments. The intent of this project was to develop a Best Practices document. As such, the goal of the literature review is primarily to establish the state-of-the-art, not to be all-inclusive on all research conducted on crack sealing and crack filling.

Chapter 3: State-of-the-Practice in Crack Treatments was developed through the use of a survey sent to maintenance engineers and material suppliers. Approximately 150 responses were received from multiple levels of agency personnel (city, county, state, federal), along with a few private-sector practitioners. The state-of-the-practice provides insight into current techniques for crack sealing and crack filling.

Finally, Chapter 4: Best Practices for Crack Treatments presents the techniques and protocols necessary to achieve good performance from crack sealing and crack filling operations. Variations between the state-of-the-art and the state-of-the-practice exist, as would be expected. The development of best practices emphasizes proper procedures in the hope of improving the state-of-the-practice.

CHAPTER 2

State-of-the-Art in Crack Treatments

Summary of the Literature Review

Scope of Work

A literature review was conducted on the state-of-the-art for crack sealing and crack filling. Approximately 115 technical publications, state specifications, and test methods were reviewed.

For ease of reference, the state-of-the-art summary and the state-of-the-practice survey are organized into the same categories. Those categories are:

- General Issues/Project Selection;
- Contracting Procedures;
- Materials;
- Construction;
- Quality Control; and
- Performance.

General Issues/Project Selection

Crack sealing and crack filling have been used as a maintenance procedure for asphalt pavements for many years. The technical literature is in general agreement with the following definitions.

Definitions

Crack sealing: Materials are placed into and/or above “working” cracks in order to prevent the intrusion of water and incompressibles into the cracks (“working” cracks refer to cracks that undergo significant amounts of movement). Crack sealing is commonly used as a transverse crack treatment (70).

Crack filling: Materials are placed into “non-working” cracks to substantially reduce water infiltration and reinforce adjacent cracks. Crack filling is commonly used as a longitudinal crack treatment (70).

Crack routing: Routing is used to open up the crack to accommodate enough sealant to provide an effective seal, even after the pavement crack opens due to contraction at low temperature during the winter months (35).

Adhesion: The binding force exerted by molecules of unlike substances when brought into contact (76).

Cohesion: That force by which molecules of the same kind or of the same body are held together so that the substance or body resists separation (76).

Working crack: Identifying whether the crack is “working” (i.e., moving as a result of contraction and expansion) or not is a challenge. In the 1999 LTPP report, FHWA defined the amount of movement for “working” classification as 2.5 mm; however, currently the value most commonly referenced is 3 mm or approximately 1/8” (23, 33, 35, 37, 70).

Masson et al. (24) present Graphic 2-1 to illustrate potential cracking conditions. Cracking illustrated in the top two line sketches is appropriate for crack treatment. The bottom sketch illustrates a branched crack condition that is not appropriate for crack treatment. Photographs 2-1 and 2-2 illustrate pavements where cracking is excessive and where crack treatments were inappropriately applied.

CalTrans (22) uses the criteria shown in Table 2-1 for crack sealing/filling. These criteria fit within the parameters previously described.

Season for Sealing

Masson et al. (24) demonstrate the effect of the time of year on sealing with Graphic 2-2.

Graphic 2-2 can be interpreted as follows:

- When sealing in the winter, the crack will be at its maximum width, as shown in the first row of the graphic. In the other seasons, the crack reduces in size and squeezes the sealer out of the reservoir.

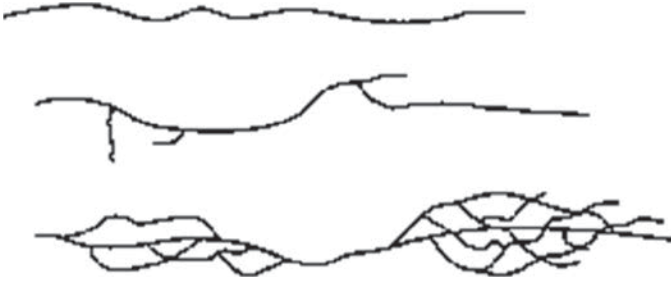

Graphic 2-1. Cracking graphic (24).

- The center image of the middle row illustrates sealing in the spring/autumn. The crack is at a “middle” size and will have less deformation of the sealant during cold and hot temperatures.
- The bottom images demonstrate that if the crack is filled in the summer when the crack is at its smallest size, extreme stresses will be induced on the sealant during the winter, potentially leading to cohesive failure.

Crack Development

Cracks initiate in asphalt pavements for multiple reasons, the discussion of which is beyond the scope of this report. After development of the crack, expansion and contraction of the pavement during hot and cold weather, respectively, causes movement in the crack. In cold weather, the crack widens as



Photograph 2-1. Wrong application (24).



Photograph 2-2. Excessive crack filling (photo by Dale Decker).

the pavement contracts. This widening allows debris to enter the crack. In hot weather, the pavement expands, thereby closing the crack. However, the debris collected in cold weather restricts closure of the crack in hot weather, resulting in deterioration of the cracked pavement. Cycles such as this cause continued deterioration of the pavement.

Masson and Lacasse (31) provide a discussion of adhesive and cohesive failures. A cohesive failure occurs in sealant that is still adhered to the crack walls. Adhesive failures occur due to debonding at or near the sealant/asphalt mixture interface. Their discussion includes precautionary comments about the compatibility of sealants and aggregates at a specific location.

Cracking Theory

- Cracks Happen
- Cracks Move
- Cracks Grow
- Cracks Get Worse
- Cracks Accelerate Pavement Deterioration

—Jim Chehovits, 2012 National Pavement Preservation Conference (79)

Crack Types

The Long-Term Pavement Performance Program (LTPP) *Distress Identification Manual* (80) identifies six primary types of cracking for asphalt pavements, namely:

- Fatigue Cracking
- Block Cracking
- Edge Cracking

Table 2-1. CalTrans cracking criteria (22).

	Crack Sealing	Crack Filling
Applicable Width	0.12"-1.00"	0.12"-1.00"
Edge Deterioration	<25%	<50%
Annual Horizontal Movement	>0.12" Working	<0.12" Non-Working
Appropriate Type of Crack	Transverse Thermal Transverse Reflective Longitudinal Reflective Longitudinal Cold Joint	Longitudinal Reflective Longitudinal Cold Joint Longitudinal Edge Block, distantly spaced

- Longitudinal Cracking (both in the wheelpath and between wheelpaths)
- Reflection Cracking at Joints
- Transverse Cracking

While treating any crack may ultimately provide some benefit to the underlying pavement structure through the reduction of moisture intrusion, the most advantageous applications for crack sealing and/or crack filling are block, longitudinal, reflection, and transverse. Unless the crack treatment is done in early-stage distress development, crack treatments for fatigue cracking do not substantially improve pavement performance; however, the treatment may reduce further deterioration of the pavement. Fatigue cracking is indicative of a structural failure in the pavement system and can only be remedied by removing and replacing the failed materials.

Many references reviewed recommend not performing crack treatments on fatigue cracks (AKA, alligator or chicken wire cracks) or edge and slippage cracking. Examples include References 3, 4, 5, 17, 22, 23, 24, 25, 33, 35, 43, 49, 72, 78, and 82.

Crack Shape Factor

In the late 1950s and early 1960s, Tons (57) and Schutz (58) established that the shape of the crack sealing material was significant. Both concluded that the crack sealing material does not change volume, just shape (cross-sectional area), during expansion and contraction. Tons showed that more shallow seals developed lower strains in the sealer. Both demonstrated that the depth-to-width proportion (so-called *shape factor*) had a critical effect on the capacity of the sealer to withstand extension and compression. Subsequent work by Khuri and Tons (64) and Wang and Weisgerber (38) determined that a rectangular shape of the sealer was preferred. Khuri and Tons recommended wide and shallow seals with a width-to-depth ratio > 1.5 to minimize strains in the sealer. Schutz recommended a width-to-depth ratio of 2 based on evaluating the strain on the sealant.

Subsequent work by Chong and Phang (35) in 1988 concluded that a 4 to 1 width-to-depth ratio performed well, particularly in cold regions, for the following reasons:

1. The strain developed in the sealant was decreased.
2. Cohesive failure in the sealant was decreased.
3. A 4:1 ratio provided greater bonding area horizontally in the crack compared to the vertical faces for square configurations.
4. Lower adhesive stress was developed on the sealant.
5. It was easier for the router operator to follow meandering cracks.
6. There was less stress on the router machine and router bits, resulting in higher productivity at lower cost.

Chong (37) further recommended that a 12 mm \times 12 mm ($\frac{1}{2}$ " \times $\frac{1}{2}$ ") rout configuration provides good performance in warmer climates and particularly for urban expressways.

Schutz noted that a bond breaker was necessary at the bottom of the crack to allow the sealer to expand and contract properly. Wang and Weisgerber further commented that bonding to the bottom of the reservoir does not have a significant effect on adhesion to the vertical walls but may lead to

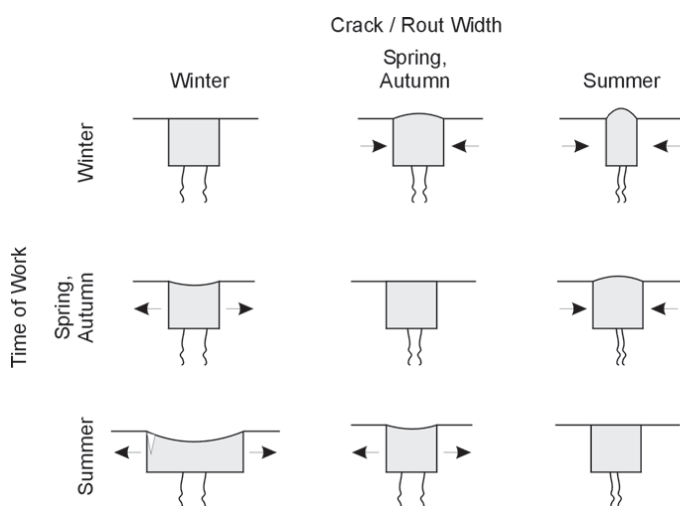

Graphic 2-2. Seasonal impact on sealing operations (24).



Graphic 2-3. Backer rod (shown as an ellipse) as a bond breaker (21).

cohesive failure in the sealant. Use of backer rod as a bond breaker is illustrated in Graphic 2-3.

Seal Geometry

Numerous crack seal configurations have been used. The following are the most common:

- Recessed Crack Seal Configuration
- Flush Fill Crack Seal Configuration with Routed Crack
- Flush Fill Crack Seal Configuration with Non-Routed Crack
- Overband Crack Seal Configuration with Routed Crack
- Overband Crack Seal Configuration with Non-Routed Crack

Graphics 2-4 to 2-6 illustrate the configurations.

The recessed crack configuration in Graphic 2-4 is commonly used when an overlay is to be placed. Flush fill, as shown in Graphic 2-5, is used in many applications and can be used prior to placement of a surface treatment. The overband is used in many applications but is commonly limited to low-speed roads.

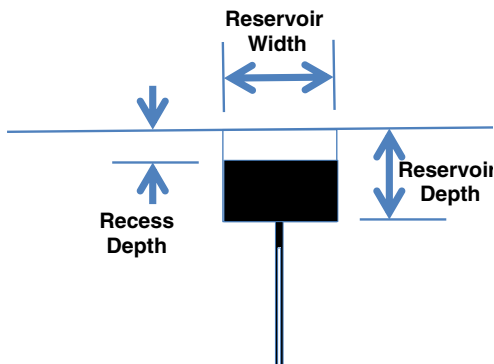

Graphic 2-4. Recessed crack seal configuration.

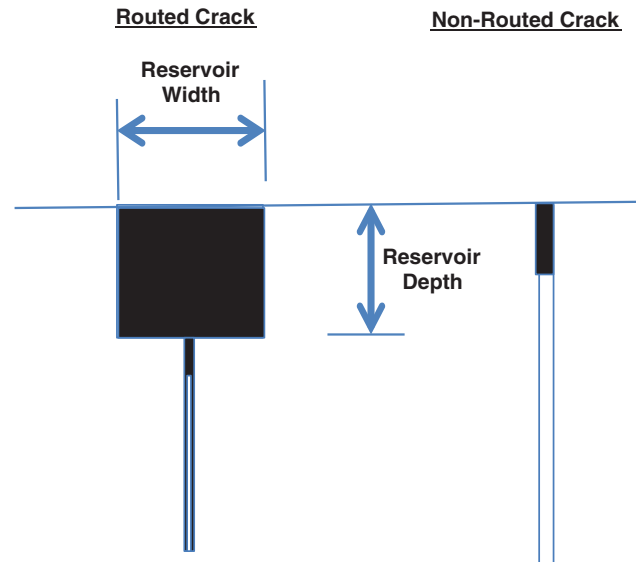

Graphic 2-5. Flush fill crack seal configuration, both routed (left) and non-routed (right).

The reservoir applications where routing is performed have the advantages of being more aesthetically acceptable, not being exposed to traffic, better adhesion to the vertical faces of the crack, and reduced tensile strains in the sealant. The only disadvantage of the reservoir configuration is the additional work and cost to the project for the routing activity. Johnson et al. (30) report that routing transverse cracks improved sealant performance, but that routing of longitudinal cracks was not necessary.

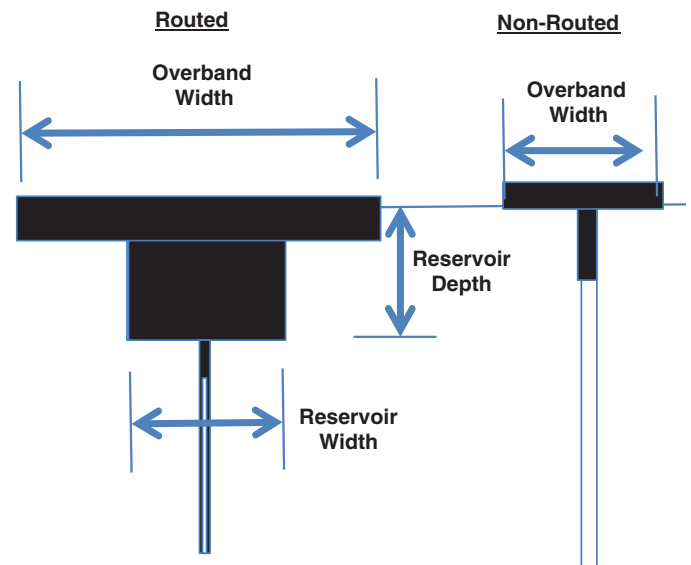

Graphic 2-6. Overband crack seal configuration, both routed (left) and non-routed (right).

Chehovits and Manning (36) describe the advantages and disadvantages of overband (also known as band-aid) versus reservoir configurations. The main advantage of the overband is the ease and speed of application. Basically, the procedure is to apply sealant into the crack and level with a squeegee. However, the disadvantages are aesthetics, exposure of the surface sealant to environmental and traffic deterioration (including snowplows), and the large and localized tensile strains that develop above the crack. Eaton and Ashcraft (23) caution that overband should not be used on city streets, parking lots, or sidewalks due to the potential for tracking. Based on a pooled fund study, Al-Qadi et al. (84) recommend the use of overband for crack filling and crack sealing.

CalTrans (22) advises against using an overband, preferring a squeegeed approach for any material left above the surface. The concerns expressed are that ride quality will suffer, with potential bumps and fat spots forming during subsequent overlays. Overbanding can be used on low-speed roads that are not slated for overlay within six months.

Filice (72) recommends a 40 mm × 10 mm (1-1/2" × 3/8") rout for transverse cracks, a 40 mm × 15 mm (1-1/2" × 5/8") rout for transverse cracks where the pavement has a chip seal, and a 19 mm × 19 mm (3/4" × 3/4") rout for longitudinal routing. {Note: Throughout this report, conversions from metric to English units are rounded to the nearest practical unit.}

Ponniah and Kennepohl (33) recommend that rout and crack sealing not be used if:

- Crack openings are less than 3 mm (1/8");
- Cracks are fatigue type;
- Crack density is high (80–100% of the pavement, or transverse cracks less than 10 m [30'] apart);
- Pavement condition is poor; or
- Overall pavement thickness is less than 50 mm (2").

Chong and Phang recommend that rout and seal treatment be accomplished within the first five years of service life of the pavement.

Contracting Procedures

Two significant schools of thought exist for the installation of crack treatments. The first is that the agency will self-perform the crack treatment installation and the second is that the agency will contract for the crack treatment services. The decision is usually based on perceived cost-effectiveness. If done in-house, oversight of the process is often not well-defined. Employees are directed to do crack sealing, the directive is followed, and little is done to verify installation quality. If contractor services are employed, owners use a variety of techniques for the purchase of crack sealing services. These techniques include:

- Unit Price—Low Bid
- Lump Sum/Firm Fixed Price
- Cost Plus
- Indefinite Delivery/Indefinite Quantity
- Warranty

As one might expect, there are advantages and disadvantages to each of the contracting approaches. The decision on how to purchase crack treatment is both an economic and political choice. This report makes no attempt to address the procedure for that decision-making process.

It is noteworthy that Michigan DOT has successfully made use of crack seal project warranties (SS-14). The warranty period chosen was two years. The warranty approach relieves the owner of future issues on sealant performance. The approach also heightens the attention-to-detail of the contractor to ensure the sealing is done properly.

Materials

The Nebraska Department of Roads Pavement Maintenance Manual (82):

"A value engineering study concluded 66% of total cost of crack sealing operations was for labor, 22% for equipment, and 12% for materials. Because crack sealing takes a lot of time, workers are exposed to traffic and motorists encounter delays. Therefore, it is safer and usually more cost-effective to use a product that will last longer, even if it is more expensive."

The materials used for crack treatments have varied widely over the years, ranging from neat liquid asphalt to asphalt emulsions to polymer and/or filler modified materials. This report does not address specific products by name but addresses material types and required properties.

The products most commonly used currently can be broadly characterized as modified asphalt products. A wide variety of modification schemes are used to satisfy the specification requirements. Discussion of the specific types of modifiers used is beyond the scope of this report.

American Society for Testing and Materials (ASTM) D6690 (TM-11) has been the reference standard for sealants for many years. Sealant manufacturers produce a variety of products that satisfy the ASTM requirements. ASTM D6690-12 identifies four different types of sealants as follows:

Type I: Sealant for moderate climates, with low-temperature performance tested at -18°C with 50% extension.

Table 2-2. ASTM tests for each sealant type (TM-11).

Test Procedure	Type I	Type II	Type III	Type IV
Cone Penetration at 25°C	<input type="checkbox"/>	<input type="checkbox"/>	<input type="checkbox"/>	<input type="checkbox"/>
Softening Point, °C	<input type="checkbox"/>	<input type="checkbox"/>	<input type="checkbox"/>	<input type="checkbox"/>
Bond, non-immersed	<input type="checkbox"/>	<input type="checkbox"/>	<input type="checkbox"/>	<input type="checkbox"/>
Bond, water-immersed			<input type="checkbox"/>	
Resilience, %		<input type="checkbox"/>	<input type="checkbox"/>	<input type="checkbox"/>
Oven Aged Resilience, %			<input type="checkbox"/>	
Asphalt Compatibility	<input type="checkbox"/>	<input type="checkbox"/>	<input type="checkbox"/>	<input type="checkbox"/>

Type II: Sealant for most climates, with low-temperature performance tested at -29°C with 50% extension.

Type III: Sealant for most climates, with low-temperature performance tested at -29°C with 50% extension—special tests are also included {ASTM notes that these specification requirements were formerly Federal Specification SS-S-1401C}.

Type IV: Sealant for very cold climates, with low-temperature performance tested at -29°C with 200% extension.

Table 2-2 indicates the tests used for each type of material. The reader is referred to ASTM D6690 (TM-11) for details of the specific test requirements and procedures.

While the ASTM procedures have been in use for many years, it is well known that fundamental engineering properties of the materials are not developed from the procedures. In addition, there is poor correlation between field performance and lab tests. As noted in Table 2-2, aging of the material is not usually evaluated. Further complicating the evaluation from a producer's perspective is the fact that many states modify the test values for local conditions (8).

Recent research by Al-Qadi et al.¹ (8) in the characterization of sealants has resulted in the development of a new grading system for sealants, loosely based on the same test methods as used for Superpave PG asphalts. The concept is to develop standard methods and procedures based on fundamental material properties. This new approach is called the Performance-Based Grading System for Hot-Poured Crack Sealant. The materials are identified by a Sealant Grade (SG) designation.

The sealant grading is identified as shown in the following example:

SG 70–16

Where

SG = Sealant Grade

70 = the high temperature performance based on tracking resistance, °C

–16 = the low temperature performance based on stiffness, adhesion, and cohesion properties, °C

As with the Superpave PG grades, the SG grades can be tailored to meet the environmental requirements for the application. The grading system is based on both a high and low temperature requirement. Any combination of high and low temperature grades shown in Table 2-3 is theoretically possible. However, it is unlikely that there will be availability of all grades in a given region. Sealant manufacturers undoubtedly produce a few products for a climatic area, but it is unlikely that all products will be available everywhere.

At low in-service temperatures, the key issues for the sealant are to achieve proper adhesion for bonding and to have adequate flexibility and extendibility to tolerate the movement of the crack. The tests used to evaluate these low-temperature

Table 2-3. Sealant Grade high and low temperatures (8).

High Temperature	Low Temperature
46	-46
52	-40
58	-34
64	-28
70	-22
76	-16
82	-10

¹ It is noted that this referenced report is an executive summary of many years of research conducted as a pooled fund program administered by FHWA. Each of the test recommendations is thoroughly evaluated in separate reports.

issues are the direct tension test, bending beam rheometer, and adhesion tests.

At high in-service temperatures, the key issues are for the sealant to have sufficient elasticity against intrusion of debris and to resist flow and softening that could result in sealant tracking. The dynamic shear rheometer test is used to evaluate these properties.

At installation temperatures, the rotational viscometer is used to evaluate the sealant properties for easy and proper installation.

In the development of the SG system, some modifications to the PG test protocols were required. The following provides a general overview of the protocol modifications to accommodate sealant products:

- *Rotational Viscometer*: Used for measuring the flow properties of the sealant; hence, upper and lower thresholds were identified as well as a change in the testing procedure. Instead of the binder hook used for conventional asphalts, a stiff metal rod replaces the wire hook and attaches to the spindle. Testing is conducted at the sealant application temperature.
- *Vacuum Oven Aging*: Used to simulate aging of the sealant during service. A modification to the shelves in the oven is required to allow a uniform temperature profile in the oven.
- *Bending Beam Rheometer*: Used to evaluate the flexibility of the sealant at low temperatures. The specimen is doubled in thickness, requiring a minor modification to the device to allow both binder and sealant testing.
- *Adhesion*: Used to evaluate the bonding between sealant and aggregate. The tests are used to ensure the sealant adheres to the crack walls and that the bond will endure the applied thermal stresses on the sealant.
- *Direct Tension*: Used to simulate field crack movements and to evaluate a sealant's ability to withstand extension. The PG test protocol is modified and the equipment has slight modifications.
- *Dynamic Shear Rheometer*: Used to evaluate tracking resistance at high temperatures. The specimen is doubled in thickness and the Multiple Stress Creep Recovery (MSCR) test is performed.

The SG system provides a set of evaluation protocols that will assist users in selecting the proper grade of sealant for a specific application. The tests are new to sealant products but are familiar in the asphalt cement testing side of the industry, albeit with minor modifications. By evaluating the rheological properties of the sealant materials, this system provides an opportunity for sealant testing to be focused on performance-based criteria.

The SG research reports provide recommendations for test criteria (8). As experience with the SG system expands, there

may be modifications to the recommendations. This same “fine tuning” approach occurred with the implementation of the PG grading system for asphalt cements.

Sampling Sealant

Many specifications have sampling requirements. Examples of the requirements can be found in References TM-11, SS-4, SS-15, SS-16, and 83. Samples may be taken: (a) from the plant or warehouse prior to delivery, (b) at the time of delivery, (c) from the melter, or (d) from the applicator nozzle. As with any sample, documenting the sample project name, date, product, and location is critical for proper record keeping. Specifications generally define the lot/sublot size and the random sampling procedure required for the product. As an example, Wyoming (SS-4) defines a lot as no more than 90,000 pounds of sealant, with sublots of 30,000 pounds each.

Construction

Even with the best of materials, improper installation of the crack sealant compromises the performance of the application. It is therefore vital to have the sealant installed in a proper manner. This section discusses research activities that have helped to establish Best Practices. Discussion of the specific Best Practices is presented in Chapter 4.

Project Design

It is critical that the condition of the existing pavement be evaluated prior to any preservation treatment. Crack treatments are no exception to that statement. It is imperative that a determination is made about potential crack movement, i.e., “working” versus “non-working” cracks, and that the pavement's past and future rehabilitation activities are understood. Currently, there is not a universally accepted standard protocol for this evaluation.

Preparation for Crack Sealing/Filling

In order for the sealant to bond, the crack must be clean and dry. Compressed air is commonly used to clean the crack.

Routing of cracks is generally performed on transverse cracks that are “working” and greater than 3 mm ($\frac{1}{8}$ ”) in width prior to crack sealing. Ponniah and Kennepohl (33) recommend routing cracks between 3 mm ($\frac{1}{8}$ ”) and 19 mm ($\frac{3}{4}$ ”) wide to a configuration of 40 mm \times 10 mm ($1\frac{1}{2}$ ” \times $\frac{3}{8}$ ”). For milder climates, Chong and Phang (35) indicate a rout of 19 mm \times 19 mm ($\frac{3}{4}$ ” \times $\frac{3}{4}$ ”) is also acceptable. Chong (37) subsequently indicates that a 12 mm \times 12 mm ($\frac{1}{2}$ ” \times $\frac{1}{2}$ ”) routing configuration works well for urban expressway applications. Eaton and Ashcraft



(A) Cutting wheel (photo by Dale Decker).



(B) Crack router (21).

Photographs 2-3. Cutting wheel router.

(23) caution that routing may be detrimental to pavements over 6 years old due to aging of the mixture.

Smith and Romine (53) recommend the use of cutter wheel routers, as shown in Photographs 2-3(A) and 2-3(B). Sharp bits are required to achieve a clean cut. Crafcro (81) further recommends that the unit be capable of following random cracks and be designed to adjust cutting widths. The unit should be equipped with a cutterhead fitted with carbide-tipped cutting tools and have variable depth control. The machine must be capable of cutting approximately 1,000 to 1,200 linear feet per hour and provide a reservoir in the pavement that meets the design for the project.

A hot air lance (HAL) (shown in Photograph 2-4) is also recommended by FHWA (53) to remove dust and moisture from the crack to ensure a better bond between the pavement and the sealant. Crafcro (81) recommends that the HAL be capable of producing air temperatures up to 750°F and be constructed of suitable hardware. The equipment should be provided with separate valves to control propane, burner air, and lance air. The fuel and the burner air should be mixed only at the point of combustion before leaving the burner tube. A separate air lance tube should pass inside the burner chamber and have a maximum orifice of ¼". At the fuel source, the propane should be controlled by a high-pressure regulator to control fuel pressure from 5 PSI to 30 PSI and to prevent flashback. Burner BTU should range from 20,000 to

500,000 BTU. A wheel kit constructed to keep the unit at the proper height and angle from the pavement, and to prevent debris from striking the operator, may also be used. Caution should be taken when using the HAL to not overheat and oxidize the pavement. A slight darkening of the pavement is acceptable.

For crack filling, generally the only preparation recommended is to clean and dry the crack. Chong and Phang (35) recommend that the maximum distance between cleaning and sealing operations be 60–80 feet.

Schutz (58) presented an argument that backer rod should be used to maintain proper shape factor for the sealant. By not having the sealant adhered to the bottom surface of the crack, the expansion and contraction of the sealant is not constrained on the horizontal surface.

Installation of Crack Sealing

For the installation to proceed, the sealant must be brought to application temperature. Crafcro (81) recommends that the melter for hot-poured applications be a self-contained double boiler device with the transmittal of heat through heat transfer oil to the sealant vessel. It must be equipped with an on-board automatic heat-controlling device to permit the attainment of a predetermined sealant temperature and, then, maintain that temperature as long as required. The



Photograph 2-4. Hot air lance (courtesy CrafcO).

melter must be capable of safely heating product to 400°F. The temperature control should not allow the heat transfer oil to exceed 525°F. There should be temperature readings of the sealant within the melting vessel and within the discharge plumbing to provide monitoring of the sealant throughout the operation. The unit shall also have a means to vigorously and continuously agitate the sealant that meets requirements of ASTM D6690. The sealant should be applied to the pavement under pressure supplied by a gear pump with a direct connecting applicator tip.

Chong (37) recommends overfilling the crack to just cover both edges of the crack and to allow for shrinkage during cooling. This approach minimizes snowplow damage for routed cracks.

Quality Control

Quality Control of a crack treatment operation consists of: (a) inspection of the operation, (b) sealant sampling and testing, (c) calibration of the equipment, and (d) inspection of the equipment. This section contains a brief discussion of each activity.

Inspection

Unfortunately, pavement preservation activities often do not command an adequate amount of attention for inspection services. With millions of dollars for a pavement reconstruction/rehabilitation project, hundreds of thousands of dollars for a

surface treatment project, and only tens of thousands of dollars for a crack treatment project, it is easy to understand how an agency will prioritize activities of limited inspection personnel with limited budget.

Likewise, training is often not a high-priority activity for crack treatment operations. Personnel need to understand the importance of their activities and the proper method of application.

Many organizations depend on on-the-job training. In some cases, this approach works well. However, it is all too easy for uniformity of on-the-job training to suffer when work needs to get done on a time schedule and manpower is limited. In addition, if bad habits are developed, generations of employees all learn the same bad habits.

Training resources on crack treatments are available, for example, through FHWA's NHI course #131110C, the National Center for Pavement Preservation, and References 3, 4, 5, 21, 22, 25, and 84.

Many states require inspectors to be certified for construction inspection. The development of an appropriately scoped certification program for crack treatment operations should be considered. As an example of one training approach, Nebraska Department of Roads (82) requires a one-hour training session prior to crack sealing activities. "Tailgate training" is an approach that has been used in a variety of situations ranging from safety training to materials handling and is an option that could be viable.

Material Sampling and Testing

When sampling any material for evaluation, it is critical that the sample truly represent the materials being evaluated. A bad sample provides bad information on the material.

Calibration of the Equipment

The key calibration component for crack sealing equipment is to ensure that the temperature control on the melter is working properly. Based on research by Masson et al. (56), overheating may cause damage to the sealant material.

Inspection of the Equipment

Equipment should be visually inspected for obvious defects prior to the start of each workday. Equipment manufacturers include maintenance recommendations with their specific equipment. These recommendations should be followed.

Performance

AASHTO's National Transportation Product Evaluation Program (NTPEP) has performed evaluations for a variety of crack treatment products and for several state agencies.

Details on these evaluations can be found at www.ntpep.org. Work done by the crack treatment pooled fund study (8, 84) also includes performance evaluations. Review of these evaluations is recommended to the reader.

Even as early as *NCHRP Report 38* in 1967, it was recognized that cold-poured materials were not performing as well as hot-poured materials (29). Yildirim et al. (21) report crack sealing without routing using cold-poured materials has a typical life cycle of 1–2 years, while hot-poured materials have a typical life cycle of 3–5 years. CalTrans (22) reports that emulsion sealants in unrouted flush fill applications have a life expectancy of 2–4 years, whereas hot-poured applications (either flush fill or overband) have a life expectancy of 6–8 years. Ponniah (34) reports that hot-poured crack treatments extend pavement life 2–5 years. Eaton and Ashcraft (23) report from their survey that emulsions for sealers (cold-poured applications) appear to only work where freeze/thaw cycles are not present for the pavement.

Cost-Effectiveness

To establish the cost-effectiveness of rout and seal maintenance treatments, Chong and Phang (35) suggest the following information is required:

1. The effectiveness of the treatment—(a) performance of sealant materials over time and (b) performance of various rout width and depth sizes over time to establish the most efficient rout configuration;

2. The extension of pavement service life—(a) retarding of additional crack development and (b) delaying the deterioration process of the existing distress; and
3. The influence of time—at which point of the pavement's life cycle the treatment is applied most cost-effectively.

While their focus was on rout and seal approaches, the suggestions for evaluation of cost-effectiveness are true for other crack treatment applications as well.

Eaton and Ashcraft (23) report that chip seal applications cost 3–14 times as much as crack sealing and that overlays cost 8–26 times as much as crack sealing. With an overlay, cracks typically reappear 1–2 years after the application, depending on the thickness of the overlay.

“No matter how expensive your sealant is, it is the least expensive part of the job.”

—Eaton and Ashcraft, 1992 (23)

Conclusion

Significant research has been conducted over many years regarding proper crack treatment materials, processes, and procedures. This literature review has documented the state-of-the-art for the processes.

CHAPTER 3

State-of-the-Practice in Crack Treatments

Summary of the Survey Results**Scope of Work**

A survey of crack sealing and crack filling procedures was developed, distributed, and analyzed. The survey was sent to state department of transportation (DOT) maintenance engineers through the American Association of State Highway and Transportation Officials Subcommittee on Maintenance. In addition, the survey was distributed to the Transportation Association of Canada, the National Association of County Engineers, and the International Slurry Surfacing Association. One-hundred fifty-seven individual responses were received, representing 28 state DOTs, 106 counties, 3 cities, 2 Federal Highway Administration (FHWA) representatives, 1 Canadian province, 2 U.S. contractors, and 1 contractor from New Zealand. Eighty-two of the 157 respondents answered all of the 71 questions. A response was received from all but nine U.S. states.

The questions in the survey were grouped into the following categories:

- Respondent Information;
- General Issues/Project Selection;
- Contracting Procedures;
- Materials;
- Construction;
- Quality Control; and
- Performance.

As would be expected, not all respondents answered every question. As a result, the number of responses varies by question and the percentages may not add up to 100%.

General Issues/Project Selection

A key issue raised in the survey is whether a distinction is made between crack sealing and crack filling. While the technical literature is quite clear regarding the need for a distinction

between crack sealing and crack filling, 62% of the survey responses indicated that no distinction is made. Whether the respondent was a state or county employee was not a clear predictor of the response. This survey response is an indication that the state-of-the-art and the state-of-the-practice are not the same.

In general, the comments were that crack sealing is used for “working” cracks that are moderate in size, in climates with significant temperature swings, and that have been routed. Crack filling is for all other applications, with a significant emphasis in warm-weather areas. Crack filling is also frequently done in preparation for a chip seal application.

Approximately 80% of the survey respondents agreed that the following are the three key criteria for determining if a pavement is a good candidate for crack sealing and/or crack filling:

- Type of crack
- Percentage of cracked area on pavement
- Crack width

About half of the respondents also indicated that crack depth was an important criterion. “Don’t wait till it’s too late” was a well-advised comment. “Almost every road is a good candidate” illustrates the pervasiveness of the cracking issue in pavement management.

How organizations specify crack sealing/filling can be summed up with one comment received: “Everyone has a different specification, which is a problem.” The specifications identified by the respondents roughly fall into one of the following categories:

- Well-defined, specific criteria (e.g., California, Michigan, Minnesota, Indiana, Texas, Montana, Wyoming, Nebraska)
- Manufacturer’s recommendations
- Anecdotal based on experience

As with most products, the DOT specification is the most commonly referenced guideline for most cities and counties.

The details of the specifications will be discussed in a later section.

Almost 90% of the respondents indicated there are some conditions for which crack sealing or crack filling is not appropriate.

- Situations where crack sealing is not appropriate:
 - Cracks are too wide, too deep, or too numerous;
 - “Non-working” cracks (filler is cheaper and quicker);
 - Pavement deterioration too severe (fatigue or alligator cracking);
 - If major surface rehabilitation/repair is scheduled within the next two years (e.g., overlay, in-place recycling, chip seal); and
 - If sealing would cover more than 25% of surface area (diminishes pavement skid safety).
- Situations where crack filling is not appropriate:
 - “Working” cracks ($\frac{1}{8}$ ” movement per year);
 - Pavement deterioration too severe (fatigue cracking);
 - If cold-in-place recycling (CIR) is scheduled in the near future; and
 - If reconstruction is scheduled within 2–3 years.

Respondents were roughly evenly split (48% yes/52% no) when asked if a specific preventative maintenance cycle was a policy of their organization. Three to six years was a typical cycle time, with many expressing that funding was the key limiting factor for the cycle time. Treating the cracks before they get too large was a common factor. Crack treatments occurring one year after an overlay or 1–2 years before a chip seal was a common theme.

Respondents were asked to estimate a typical life span for crack sealing and crack filling on both major and minor roads. Table 3-1 provides the estimated life spans for crack sealing

and crack filling by percentage of respondents. The conclusion from this information is that the majority of respondents think crack sealing on both major and minor roads can perform for 5–10 years, but that crack filling will only last 1–4 years.

Eighty-eight percent of respondents indicated that the crack sealing/filling requirements for major versus minor roads were the same. While there was agreement that cracks should be regularly treated, some respondents indicated that chip sealing for minor roads may be more cost-effective than crack treatments. Ninety-three percent of respondents indicated that the same materials are used regardless of the road type.

Organization budgets for crack sealing/filling were quite variable, ranging from \$100,000 to \$10,000,000. Eighty-six percent of the budgets reported were under \$500,000. The number of miles of crack sealing/filling per year was also quite variable, ranging from 25 to 5,000. Seventy-seven percent of the respondents indicated less than 100 miles of crack sealing per year.

Based on the survey responses, the installation of crack sealer and/or crack filler is done with in-house personnel about 60% of the time. The survey responses were frequently either 100% in-house or 0% in-house. The conclusion is that many agencies either do all of the installation or none of it.

The materials and installation specifications were the same for both in-house and contract work for 84% of respondents. Eighty-two percent of respondents indicated that their experience with in-house crack sealing/filling was good to excellent, with minor difficulties. The participants were asked to identify the primary and most common problems associated with in-house crack sealing/filling operations. Table 3-2 lists the primary problems and the most common problems in order of the importance given by the respondents.

Table 3-1. Survey responses for typical life span for crack sealing and crack filling.

	Years	Major Roads	Minor Roads
Crack Sealing	1 – 4	46%	38%
	5 – 10	54%	55%
Crack Filling	1 – 4	56%	50%
	5 – 10	36%	33%

Table 3-2. Survey responses for crack treatment problems in work done by in-house personnel.

Primary Problem	Most Common Problem
Application Equipment	Application Equipment
Overfilling Crack	Overfilling Crack
Routing Crack	Routing Crack
Drying Crack	Temperature of Application
Temperature of Application	Underfilling Crack
Underfilling Crack	Drying Crack
Handling Materials	Handling Materials

Table 3-3. Survey responses for crack treatment problems in work done by contract personnel.

Primary Problem	Most Common Problem
Underfilling Crack	Underfilling Crack
Routing Crack	Routing Crack
Drying Crack	Drying Crack
Overfilling Crack	Overfilling Crack
Temperature of Application	Temperature of Application
Application Equipment	Handling Materials
Handling Materials	Application Equipment

It is noteworthy that the first three issues in both lists in Table 3-2 are the same and in the same order. Sixty-seven percent of the respondents listed the first three as the primary problem, and 58% of the respondents listed the first three as the most common problem.

Eighty-one percent of the respondents indicated that their experience with contract crack sealing/filling was good to excellent, with minor difficulties. The participants were asked to identify the primary and most common problems associated with contract crack sealing/filling operations. Table 3-3 lists the primary problems and the most common problems in order of the importance given by the respondents.

It is noteworthy that the first five issues in both lists in Table 3-3 are the same and in the same order. Ninety percent of the respondents listed the first five as the primary problem and 92% of the respondents listed the first five as the most common problem. The most common comment regarding contract crack sealing/filling was the out-of-pocket expense to the owner. A higher level of inspection was also required for contract crack sealing/filling.

In comparing the in-house versus contract sealing responses (Table 3-2 versus Table 3-3), some observations are noteworthy:

- In-house sealing may not have good equipment available;
- Improper crack filling, routing, and drying are consistent issues for both in-house and contract sealing; and
- There appears to be a tendency for in-house sealing to overfill the crack and contract sealing operations to underfill the crack.

Overfilling/underfilling the crack is likely a reflection of a lack of training for both in-house and contract personnel. In-house personnel may believe that more is better. Contractor personnel, particularly if the project is low bid, may be underfilling to save money. In either case, personnel need to understand the potential impact of their actions on the performance of the seal treatment.

The survey queried the participants regarding the type of crack that is appropriate for both crack sealing and crack filling. Table 3-4 presents the results of those questions. Respondents commented that the severity of the cracking and the timing of the crack treatment were key determinants. Some commented that all cracks are treated. These responses are in general agreement with the state-of-the-art recommendations.

The survey asked participants to identify required climatic conditions for both crack sealing and crack filling. Table 3-5

Table 3-4. Types of cracks by treatment type—order of priority by respondents.

Type of Crack for Crack Sealing	Type of Crack for Crack Filling
Transverse Cracking	Joint Cracking
Reflective Cracking	Edge Cracking
Low Temperature Cracking	Transverse Cracking
Joint Cracking	Reflective Cracking
Edge Cracking	Fatigue Cracking
Fatigue Cracking	Low Temperature Cracking

Table 3-5. Climatic conditions required, % response.

	Crack Sealing	Crack Filling
Minimum Air Temperature	89.4	60.6
Maximum Air Temperature	80.8	61.5
Minimum Pavement Temperature	88.1	64.4
Maximum Pavement Temperature	87.0	52.2
Recent Precipitation	89.2	64.6
Forecast Precipitation	87.8	65.9
Absence of Fog/Dew	87.5	77.1
Direct Sunlight	85.7	42.9

Table 3-6. Survey responses on crack dimensions for crack sealing and crack filling.

	Percentage of Responses		Crack Dimensions, inches	
	Crack Sealing	Crack Filling	Crack Sealing	Crack Filling
Width, min	80.3	81.7	0.24	0.42
Width, max	71.1	71.7	1.01	1.66
Depth, min	51.3	58.3	0.72	1.00
Depth, max	51.3	60.0	3.00	4.14
Time since last treatment	39.5	38.3	4.5 (years)	4.75 (years)

presents the percentage of responses for each issue. From this information, it is apparent that respondents pay more attention to climatic conditions for crack sealing than for crack filling. The range of temperatures given most commonly was 40–70°F. Generally, cooler temperatures are preferred so that the crack is wider.

Participants in the survey were asked the typical crack sealing/filling season. The answers were given in months. A numerical value was assigned to each month (January = 1, February = 2, etc.), and an average value was calculated. This calculation established that the average season was from May to August. Clearly this will be variable for different regions of the country. The season for hot, southern climates is generally during the winter months.

The survey queried the participants regarding criteria for the type of crack for both sealing and filling. Table 3-6 presents the percentage of responses for both crack treatments and the numerical values reported for each type of treatment.

The interpretation of Table 3-6 is that about 80% of the respondents indicated minimum crack width was a criterion for both crack sealing and crack filling (80.3% and 81.7%, respectively). The respondents reported a minimum crack width of 0.24" for crack sealing and 0.42" for crack filling. The data show that both minimum and maximum crack width are the two most important criteria. As expected, the crack dimension criteria for crack sealing are smaller than for crack filling. The time since the last treatment is seen to be a low priority criterion but, for the few responses, does indicate an average time between treatments of 4–5 years.

Contracting Procedures

The manner in which agencies purchase goods and services is important regardless of the type of product. This section of the survey questioned participants about the process through which crack sealing/filling materials and services are obtained.

Seventy-eight percent of the respondents did not have a prequalified contractor list for their organization. Remember that 60% of sealing is done with in-house personnel. The type of contract and percentage of use are shown in Table 3-7. (Note: Respondents could check multiple contract types, so the values do not add up to 100%.)

Table 3-7. Types of contracts used by respondents.

Contract Type	Percentage Use
Unit Price – Low Bid	90.0
Lump Sum/Firm Fixed Price	20.0
Cost Plus	6.7
Indefinite Delivery/Indefinite Quantity	6.7
Warranty	11.7

Two interesting comments were generated relating to the contract type. One was that warranty projects generally have better performance. The second comment described a modified unit price approach. The agency (in this case, a county in Texas) provided the contractor with material for the crack treatment, thereby removing the risk to the contractor on quantity of material. The contractor then bid the cost of a crew (including equipment) as defined in the contract.

Participants in the survey were asked how crack sealing/filling is measured. Fifty-three percent of respondents indicated the measurement was by weight of material applied, 46% by linear feet of cracking, and 33% by quantity of crack sealer applied. Respondents could check multiple measurement methods, so the values don't add up to 100%. Some comments were made about using centerline miles of roadway as the measurement method. This would require an established percentage of cracking in order for the arrangement to be equitable to both the owner and the contractor.

Seventy-six percent of the respondents indicated that a warranty was required for crack sealing/filling projects. The average length of warranty was 1.4 years.

Materials

Selection and approval of materials is an important effort for any pavement owner. Generally materials are specified using standard generic requirements. This section of the survey focused on requirements for proper materials for crack sealing and crack filling. This survey did not address specific crack sealing/filling products by name in order to avoid any proprietary issues.

Often agencies have an approved list of materials for the products used in highway construction. For crack sealing/

filling, 64% of the respondents indicated that their organization had an approved list of materials. As is often the case, most local agencies reference the state DOT specifications.

Material handling safety is an integral part of any construction project. The survey results indicated that 64% of respondents required safety training for employees. Forty-one percent required annual safety training. Some respondents indicated that the contractor might require safety training even though the agency may not.

Seventy-seven percent of the agencies responding required Personal Protective Equipment (PPE) for workers applying crack sealing/filling materials. Typical PPE required are: long pants (97%), gloves (89%), safety shoes (85%), face/eye protection (78%), and long sleeves (68%). Appropriate safety vests are of course required on all construction projects and, in some cases, so are hardhats.

Construction

If the construction process is not completed correctly, the best design and materials will make no difference. This section of the survey focused on requirements for proper construction of the crack sealer/filler. Traffic control requirements are not included in this discussion.

The typical road preparation methods prior to crack sealing/filling are to sweep the pavement (77% of responses) and to dry the pavement (63% of responses). Stated objectives are to ensure that the cracks are clean and dry using either air blowing or a hot air lance.

Cleaning of the cracks prior to sealing/filling is a critical element in good performance of the crack treatment. Table 3-8 presents the cleaning methods used by respondents.

Backer rod is seldom used for rout and seal applications—just 19% of respondents indicated use. The primary uses are for very large cracks and for concrete joint sealing.

The issue of whether or not to rout cracks is a contentious matter. There were 52 responses to the survey question, with 50% reporting they never rout a crack, 35% reporting they rout in areas of high thermal movement, and 31% reporting they rout in areas of high-performance applications. Out of the 52 responses, 27% of the respondents indicated they rout all cracks prior to treatment.

Table 3-8. Crack cleaning methods.

Cleaning Method	Percentage of Respondents
Compressed Air	89.5
Routing of Crack	42.1
Hot Air Lance	35.5
Sawing	7.9
Wire Brush	5.3
Pressurized Water	1.3
Sand Blasting	1.3

Fifty-six percent of the survey participants indicated that the surface of the sealer is squeegeed after application of the sealer/filler. Another 16% stated it was done sometimes.

Five different crack seal configurations were presented to the survey participants, with a series of questions relating to the use of each configuration. The configurations identified were as follows:

- Recessed Crack Treatment Configuration
- Flush Fill Crack Treatment Configuration with Routed Crack
- Flush Fill Crack Treatment Configuration with Non-Routed Crack
- Overband Crack Treatment Configuration with Routed Crack
- Overband Crack Treatment Configuration with Non-Routed Crack

Graphics 3-1 to 3-3 illustrate these configurations. For each of the configurations, the survey participants were asked about the conditions for use, the typical dimensions, and the typical procedures.

Table 3-9 provides a summary of the responses regarding crack configurations. As noted in Table 3-9, 35% of respondents always use the recessed crack configuration, but 65% of respondents never do. The recessed crack seal configuration was used prior to same-season overlay, for construction joints, for wider cracks where rout and seal is done, for thermal moving cracks, and for wide longitudinal crack filling. The average dimensions reported by respondents were a reservoir width of 0.83", a reservoir depth of 0.82", and a recess depth of 0.29".

Forty-eight percent of respondents always or most of the time use a flush fill crack seal configuration, while 21% never use this configuration. Average dimensions for the flush fill routed crack were 0.86" × 0.84" for reservoir width and depth, respectively.

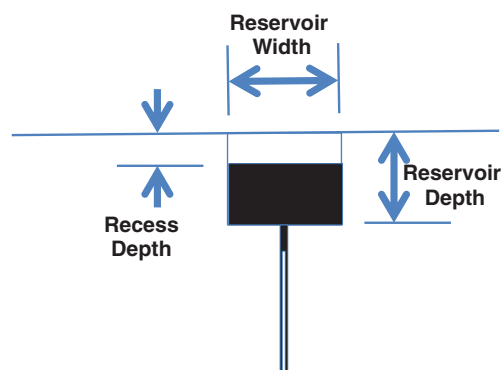

Graphic 3-1. Recessed crack treatment configuration.

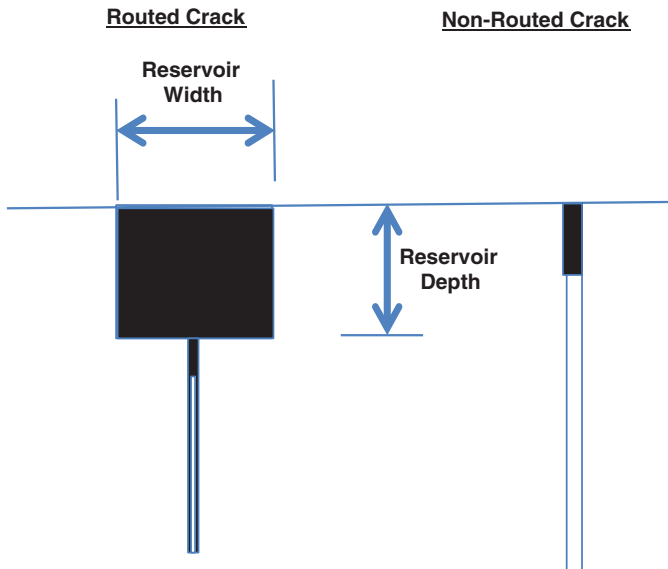

Graphic 3-2. Flush fill crack treatment configuration, both routed (left) and non-routed (right).

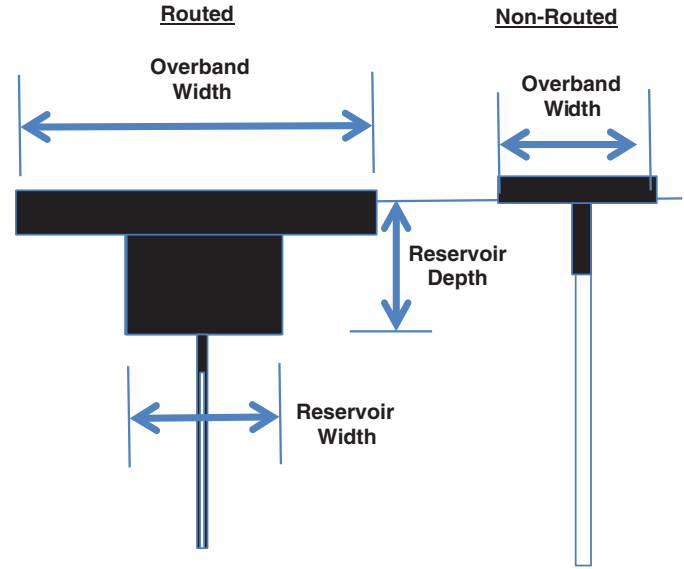

Graphic 3-3. Overband crack treatment configuration, both routed (left) and non-routed (right).

Forty-three percent of respondents always use an overband crack seal configuration (with an additional 8% using it most of the time), while 28% never use this configuration. Average dimensions for the overband routed crack were 1.18" × 0.94" for reservoir width and depth, respectively. The average reported overband widths for routed and non-routed cracks were 2.49" and 3.28", respectively.

Survey participants were asked about three different anti-tracking mechanisms: blotter sand, release agent, and plastic/paper. All of these are used in different areas of the country to prevent tracking of newly placed crack sealer/filler by traffic. The predominant response is that blotting materials are not used—75% do not use blotter sand, 62% do not use release agent, and 70% do not use plastic or paper on the crack sealer/filler after application. General responses were that if

tracking becomes a problem on a specific project, consideration would be given to one of these techniques as a solution. Two creative approaches are to (1) use dishwashing soap and (2) use toilet paper. Anti-tracking products are available from some manufacturers.

The survey asked about possible changes in preparation, materials, configuration, or placement of crack sealant prior to an overlay or prior to placement of a surface treatment. The overwhelming response (92%) for the overlay scenario indicated the primary issue is the time between the crack sealing technique and the overlay construction. For crack sealing/filling prior to a surface treatment, the response was just as strong, with 94% indicating that the time between activities is the principal issue. The preparation, materials, and configuration were considered incidental to the time between activities.

Table 3-9. Summary of crack configuration responses from survey.

Configuration Type	Recessed (Graphic 3-1)	Flush Routed (Graphic 3-2[left])	Flush Non-Routed (Graphic 3-2[right])	Overband Routed (Graphic 3-3[left])	Overband Non-Routed (Graphic 3-3[right])
Percent Usage*	35/65	48/21	48/21	43/28	43/28
Reservoir Width, in	0.83	0.86	-----	1.18	-----
Reservoir Depth, in	0.82	0.84	-----	0.94	-----
Recess Depth, in	0.29	-----	-----	-----	-----
Overband Width, in	-----	-----	-----	2.49	3.28

*Always Use/Never Use

For sealant placed prior to an asphalt overlay, 54% of the participants indicated that no changes were made to crack sealing/filling operations. The time to complete crack treatments prior to overlay varied from one to three years, with a one-year wait being a common response. If a same-season overlay is to be done, respondents believed that the configuration should be of the recessed type.

For sealant placed prior to an asphalt surface treatment, 47% of the participants indicated that no changes were made to crack sealing/filling operations. The time to complete crack treatments prior to surface treatment is recommended to be one season before the surface treatment. If a same-season surface treatment is to be done, the crack treatment should be performed at least one month prior to the surface treatment—the longer time available, the better. Seventy-seven percent of respondents indicated that the crack sealing procedures do not vary depending on the type of surface treatment planned. Comments of note:

- Do not rout cracks if microsurfacing is to be applied.
- Create a test strip to validate compatibility of the crack seal with surface treatment, especially if any solvents are used.
- Do not perform Hot-In-Place recycling over crack seal material—there is a fire danger.

Quality Control

For each element of the highway construction process, it is important to ensure the quality of the products and processes. It is generally understood in the highway construction industry that the contractor is responsible for Quality Control while the owner is responsible for Quality Assurance. These activities define the seller's and buyer's risk for the materials and processes used in highway construction. This section of the survey focused on requirements for Quality Control of the crack sealer/filler materials and application processes.

Participants in the survey were asked if an inspector is on-site during the crack sealing/filling operation. The responses were 36% yes, 38.7% no, and 25.3% sometimes. The “sometimes” generally depended on whether the work was being done by in-house staff or a contractor and on the availability of personnel for the inspection. While staffing is a challenge for most agencies, the comment was made that there is generally better performance of the crack sealing/filling if an inspector is present during construction activities. From a performance perspective, the inspector primarily checks for application techniques and that the crack is clean and dry. Other issues included in the inspection are the material temperature, quantities, approvals, traffic control, and safety.

Agency personnel perform 75% of the inspection activities, with 11% done by a private consultant and 6% by the contractor. Seventy-one percent of respondents indicated

that a final inspection is performed on the crack sealing/filling operations. The final inspections are performed by agency personnel (39%), agency inspectors (32%), and roadway superintendents (29%). Sixty-seven percent of respondents indicated that no training and/or certification program exists for crack sealing/filling. Several participants mentioned on-the-job training as the key training approach.

It is interesting to note that the 1967 NCHRP report on crack sealing recommended an education program to alleviate the problem of inadequate performance of sealing efforts (29). Not much has changed in that regard in an almost 50-year time span. In a 2008 document, Minnesota DOT further recommended training, stating that improvements in crack sealing installation procedures are needed (43). The results of this survey demonstrate that the recommendations are currently valid.

Seventy-seven percent of participants indicated that no sampling and testing of the crack seal/fill material is done during the construction process. There is a wide range of sampling and testing approaches: some agencies pre-test material; some have approved supplier certifications; some sample from melters; some job sample and test later. Many commented that they only test when they think there is a problem. Ninety-four percent of respondents indicated that no field acceptance tests are performed. The foundation for most testing is the ASTM requirements.

Eighty-four percent of participants indicated that no calibration or inspection of the application equipment is performed. Reference is made to state DOT specifications and daily “walk-arounds” but no specific calibration or inspection program.

Performance

The most important part of any material application is the final performance of the product. This section of the survey focused on requirements for performance measurement of the crack sealer/filler materials and application processes.

Seventy-four percent of the respondents indicated that no performance measurement for crack sealing/filling is conducted. Comments indicated that qualitative evaluations are conducted (e.g., visual examination), but there is no quantitative performance measurement (e.g., test results).

Participants were asked to identify common distresses in crack sealing/filling and to indicate which was the most common problem. Table 3-10 presents the results of these questions. The responses clearly show that lack of bond is the largest source of failure for crack treatments, with cohesive failure being the second most common distress type. In addition to those distress types, respondents also identified oxidation of the crack sealer/filler and construction-related issues that impact performance of the crack sealer/filler.

Table 3-10. Distresses noted by survey participants.

Distress Type	Distress Observed, %	Most Common Distress, %
Lack of Bond	78.9	57.5
Cohesive Failure	48.1	20.0
Raveling of Crack	25.0	10.0
Spalling of Crack	17.3	12.5

Eighty-one percent of the participants indicated that deicer applications do not affect sealant performance. The only situation in which deicer was noted to have an impact on sealant performance is if the sealant is applied shortly after a deicer application. Time between deicer and sealant applications appears to reduce any potential effect. Routing of the crack also removes some of the material that may be contaminated by deicer products.

Ninety percent of the respondents indicated that they do not quantify the effect of sealant on pavement life. Research activities on this issue were discussed previously in this report.

The final survey question asked the participants to rank factors in order of importance in minimizing defects in crack treatments. Table 3-11 presents the results. Clearly, cleaning the crack is considered to be the most important issue by all respondents. The second grouping of ranking values (4.21 and 4.68) includes the sealant used and precipitation at the time of installation, which were strongly considered to be of importance. The third grouping (3.33 to 3.75) includes construction procedures, temperature at installation, and crack routing. The participants did not consider the equipment used to be as important as the other factors.

Conclusion

The response to the survey was excellent. Participants were willing to share their experience with crack sealing/filling through the extensive survey questions. The survey clearly indicates differences between the state-of-the-art and state-of-the-practice. These differences will be discussed in Chapter 4.

Table 3-11. Ranking of factors important to minimize defects in crack treatments.

Factors to Minimize Defects	Average Ranking Value	Order of Importance
Proper Crack Cleaning	5.61	1
Sealant Used	4.68	2
Precipitation at Installation	4.21	3
Construction Procedures/Techniques	3.75	4
Temperature at Installation	3.71	5
Proper Crack Routing	3.33	6
Equipment Used for Installation	2.71	7

CHAPTER 4

Best Practices for Crack Treatments

It is well established that crack sealing and crack filling are cost-effective pavement maintenance techniques. As with any other activity, it is imperative that the work be done with appropriate equipment and in the best manner possible in order to get good performance. Many organizations have maintenance manuals that include Best Practices for crack sealing and crack filling. Examples can be found in References 3, 4, 5, 7, 14, 16, 22, 24, 25, 43, 44, 49, 53, 82, and SS-3. Based on review of the State-of-the-Art and State-of-the-Practice, this chapter synthesizes the Best Practice requirements to achieve a long-lasting crack treatment.

General Issues/Project Selection

FHWA describes the steps in a crack treatment program as follows:

1. Obtain and review construction and maintenance records. This includes determination of the pavement age, design, repairs done to date, etc.
2. Perform a pavement crack survey. Record the distress types present, the amount of distress, and the severity of distress.
3. Determine the appropriate type of maintenance for the cracked pavement based on the density and condition of cracks.
 - a. A pavement surface treatment is appropriate for a pavement with high density of cracks that have moderate to no crack edge deterioration.
 - b. A crack treatment is proper for a pavement with moderate density of cracks that have moderate to no crack edge deterioration.
 - c. A crack repair is necessary for pavements with moderate density of cracks that have a high level of crack edge deterioration.
4. For crack treatment, determine whether cracks should be sealed or filled.

- a. Cracks with significant annual horizontal movement (“working” cracks) should have a crack sealing treatment.
- b. Cracks with little annual horizontal movement (“non-working” cracks) should have a crack filling treatment.
5. Select materials and procedures for the crack treatment operation based on environmental, equipment, personnel, and cost-effectiveness considerations.
6. Acquire materials and equipment to perform the work.
7. Conduct and inspect the crack treatment operation.
8. Periodically evaluate treatment performance. (53)

The first three steps are contained within a typical pavement management system. The remaining steps will be discussed in the following sections.

The definitions for crack sealing and crack filling presented in Chapter 2 are considered as the Best Practice for evaluation of pavement cracking. It is widely accepted that crack sealing is for “working” cracks with an opening greater than $\frac{1}{8}$ ” (3 mm) in the summer and with minimal crack edge deterioration. The opening will be much greater in the winter. The cracks will often be uniformly spaced along the pavement and have limited edge deterioration. Often these cracks are routed prior to sealant installation.

Crack filling is applicable for “non-working” cracks that show little movement over time and have low to moderate crack edge deterioration. “Non-working” cracks are not typically routed. These definitions generally lead to transverse cracks receiving a crack seal treatment and longitudinal cracks receiving a crack filling treatment. Both crack sealing and crack filling can be performed at the same time in different areas of a given project.

It is noted that crack sealing techniques and products can be effectively used for both “working” and “non-working” cracks.

Michigan DOT (16) recommends the evaluation of crack density as shown in Table 4-1.

These recommendations roughly translate into the requirement of two or three full-width transverse cracks in the 328 ft

Table 4-1. Evaluation of crack density (16).

Linear Crack Length per 100m (328ft) pavement section	Density Definition
< 10 m (33ft)	Low
10m (33ft) to 135m (443ft)	Moderate
>135m (443ft)	High

evaluation section for crack treatment to be justified (16). These guidelines of course require good engineering judgment to ensure appropriate work is performed.

In order to differentiate between a “working” and “non-working” crack, an owner must evaluate the pavement over a period of time to determine the extent of the crack movement. Unfortunately, proper evaluation of pavement cracking condition is often not performed prior to crack treatment operations.

As a generality, crack sealing is typically performed in cold weather climates and crack filling is performed in warm weather climates. As noted in Chapter 3, many agencies do not differentiate between crack sealing and crack filling. This likely precipitates some of the performance issues experienced by some agencies.

Contracting Procedures

The manner in which an owner specifies and pays for crack treatment services is not the primary determinant for the performance of the treatment. The work may be done in-house or by contract personnel. Whether a low bid, lump sum, cost plus, indefinite delivery/indefinite quantity, or warranty contracting approach is used is not the key crack treatment performance predictor. Any of these approaches have the possibility of producing a crack treatment with good performance. Consideration must be given to what works best for a specific owner, what works best for the project, and what fits within the economic and political environment of the project. The deciding factors, as Jim Sorenson said, are using the right materials at the right time for the right conditions. This author adds that these activities must be coupled with the right people with the right training to perform the work.

Materials

The materials used for crack treatments vary in different regions of the country. States with extensive freeze/thaw activity need sealants with more ductility, while warmer areas require sealants with less flow in hot weather (23).

The materials used for crack sealing are generally polymer modified asphalt based materials and are applied at high temperature (hot-poured sealants). The materials used for crack filling can be either hot-poured or cold-applied

materials and are often asphalt emulsions. It has been shown that cold-applied materials, while easily penetrating into the crack, do not perform nearly as well as hot-poured sealants. However, the emulsion products are typically significantly less expensive.

The materials used for any crack treatment project must be decided by the project engineer. This report makes no attempt to recommend or evaluate specific commercially available products. There are many products available with each having advantages and disadvantages. The purchaser of the sealant must make the product determination based on local experience and knowledge. It is noted that NTPEP is a good resource for materials evaluation information. In addition, many agencies have an Approved Products List.

Sealants are selected in a given region based on the manufacturer’s test results for the product. A prudent owner should verify the manufacturer’s results. The Federal Highway Administration’s (FHWA) LTPP Bind software provides guidance to the user for determination of pavement temperatures for a specific sealant grade.

ASTM D977 (Standard Specification for Emulsified Asphalt [TM-12]) and D2397 (Standard Specification for Cationic Emulsified Asphalt [TM-13]) are used to evaluate cold-applied emulsion products. The emulsion specifications are focused on the emulsion product and not on the crack fill application.

ASTM D6690 (TM-11) is used to evaluate hot-poured materials. These ASTM sealant specifications have been in use for many years. A new SG system has been developed to better address environmental variables that impact the performance of hot-poured materials, as discussed in Chapter 2. It is expected that sealant purchasers and manufacturers will adopt the SG system at some time in the future.

Construction

This section of the Best Practices will discuss the following issues:

- Climatic conditions
- Crack configurations
- Crack preparation
- Crack cleaning
- Material preparation
- Sealant installation
- Safety

Climatic Conditions

The environmental conditions at the time of sealant placement have a significant impact on the performance of the sealant. Typically the temperature should be between 40°F

and 70°F for both crack sealing and crack filling. Al-Qadi et al. (84) recommend a range of 40–80°F.

Montana DOT (5) has requirements for the following weather considerations:

- Temperature of the roadway surface should be 35°F and rising.
- Humidity should be 50% or lower. High humidity may reduce adhesion of the sealant to the crack edges. Excess moisture can be observed as small bubbles forming in the sealant.
- Wind may be a friend or a foe. A gentle wind can help to cool the sealant more quickly, minimizing sealant tracking issues. However, wind can also cause problems when cleaning the cracks, with the potential for flying debris. Cold winds will increase the melter heating time.
- Rain is cause for immediate shutdown of the crack treatment operation. If an unexpected shower occurs, any crack that has been cleaned and dried must be re-evaluated for proper conditions.

Crack Configurations

From the survey, there was no single crack treatment configuration that was overwhelmingly favored. Rather, different applications call for different treatment configurations. Reservoir configurations are commonly used when crack sealing will occur. The reservoir provides a mechanism for expansion and contraction during which adhesion of the sealant to the crack edges remains intact. Reservoirs are not typically used for crack filling operations. Each of the configurations has advantages and disadvantages. A discussion of each configuration follows.

Recessed Crack Treatment Configuration

The recessed crack treatment configuration (Graphic 4-1) is often used when an overlay is to be placed. The recess mini-

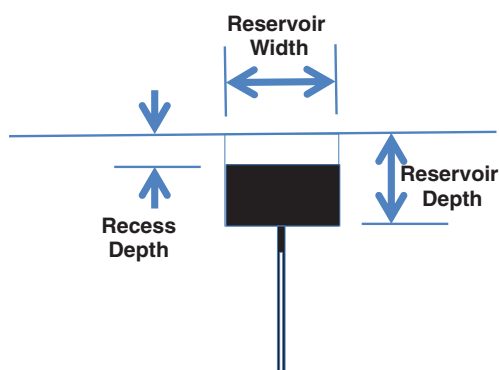

Graphic 4-1. Recessed crack treatment configuration.

mizes the potential for a bump to form in the overlay, which can occur when the hot overlay comes in contact with the sealant. A recess depth of approximately $\frac{3}{8}$ " is commonly used. The sealant should be placed 6–12 months prior to the overlay to minimize potential for bumps. Survey results indicated that the recessed crack treatment configuration is not commonly used (35% usage).

Flush Fill Crack Treatment Configurations

Approximately 50% of the survey respondents use flush fill configurations all the time. The configuration can be used with either a routed (Graphic 4-2[left]) or non-routed approach (Graphic 4-2[right]). The flush fill is commonly used when a chip seal or microsurfacing is to be applied on the pavement. Because of the lower temperature of the surface treatment, there should be no concern about bump formation. The non-routed flush fill is commonly utilized with crack filling using an emulsion. The emulsion will readily flow into the crack.

Photographs 4-1 illustrate squeegee operations to smooth the surface of the treated crack. The type of squeegee is determined by the sealant used. A hot sealant uses the all-metal squeegee shown on the left, while cold-poured materials have a rubber-faced squeegee as shown on the right.

Overband Crack Treatment Configurations

Overband crack treatment configurations (Graphic 4-3) are used when traffic will be on the treatment soon after placement. Low-traffic roadways are good candidates for this type of treatment. Care must be taken to avoid excess sealant on the surface from a traffic safety perspective and from a sealant

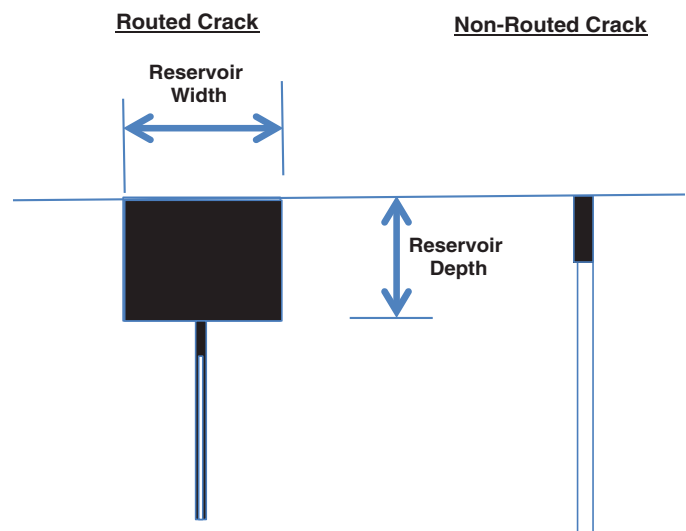

Graphic 4-2. Flush fill crack treatment configurations.



Photographs 4-1. Squeegee for sealant (hot-poured sealant on left, cold-poured sealant on right) (21).

integrity perspective. If the sealant sticks to vehicle tires, it can be pulled out of the crack, resulting in a failure of the crack sealant. This application should not be used if an overlay is planned as the potential for a bump in the overlay is high. The non-routed application is often used for crack filling. The surface may be squeegeed to smooth the overband.

Installation of an overband application is shown in Photograph 4-2. The overband material may be squeegeed flat or may be left as a “cap.” The overband should be no more than 3” wide. Photograph 4-3 illustrates the condition of a pavement with excessive sealant overband application.

Chong (37) recommends overfilling the crack to just cover both edges of the crack and to allow for shrinkage during cooling. This approach minimizes snowplow damage for routed cracks.



Photograph 4-2. Overbanding (22).

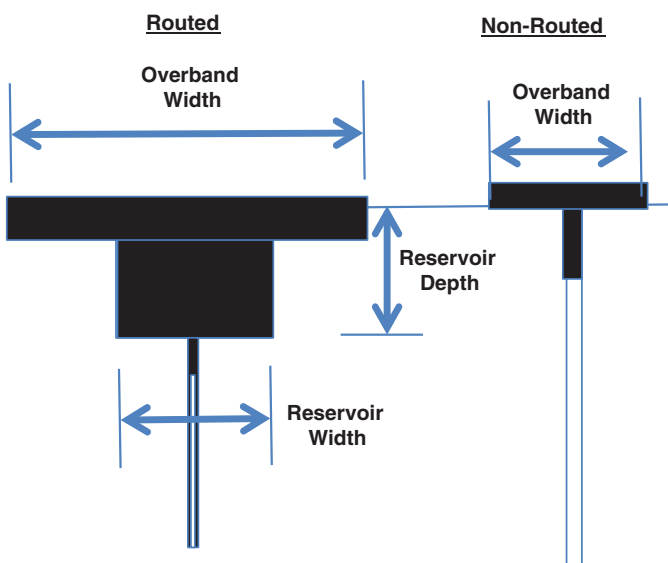

Graphic 4-3. Overband crack treatment configurations.



Photograph 4-3. Excessive overbanding (22).

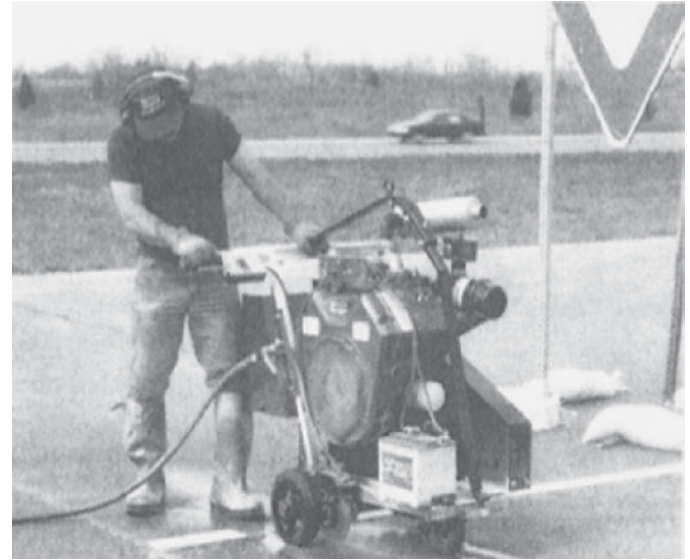
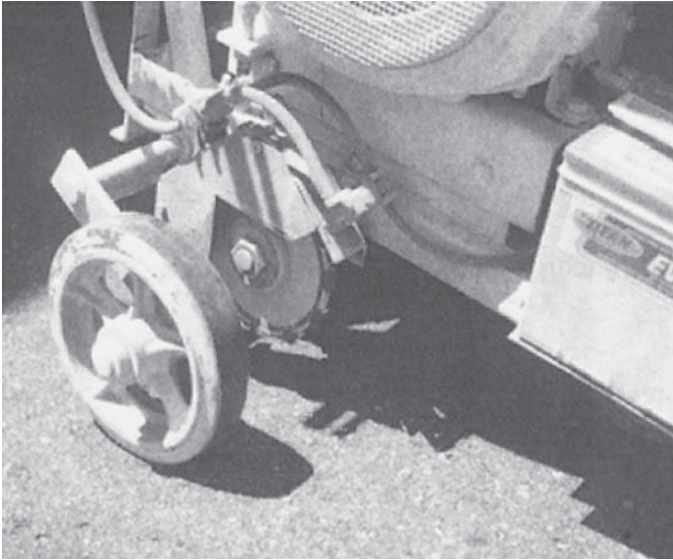

Photographs 4-4. Diamond saw crack cutting (16).

Crack Preparation

A controversial subject is whether to cut the crack prior to the treatment. Crack cutting can be performed either by a diamond saw or a rotary impact router, shown in Photographs 4-4 and 4-5, respectively. Table 4-2 provides an overview of the advantages and disadvantages of the saw and router. As a result of the productivity advantage and the ability to follow the crack more closely, the router is the most commonly used cutting procedure. However, less than half of respondents in the survey routinely rout

cracks (recessed routed 35%, flush routed 48%, and over-band routed 43%). Routing is a process that should be evaluated by agencies in more detail—it is a good tool for the toolbox.

Filice (72) provides recommendations for routing selection:

Do Rout:

- crack opening 3 mm to 12 mm ($\frac{1}{8}$ " to $\frac{1}{2}$ ")
- cracks 12 mm to 20 mm ($\frac{1}{2}$ " to $\frac{3}{4}$ ") shall be evaluated to determine appropriateness
- cracks greater than 19 mm ($\frac{3}{4}$ ") shall be cleaned and filled

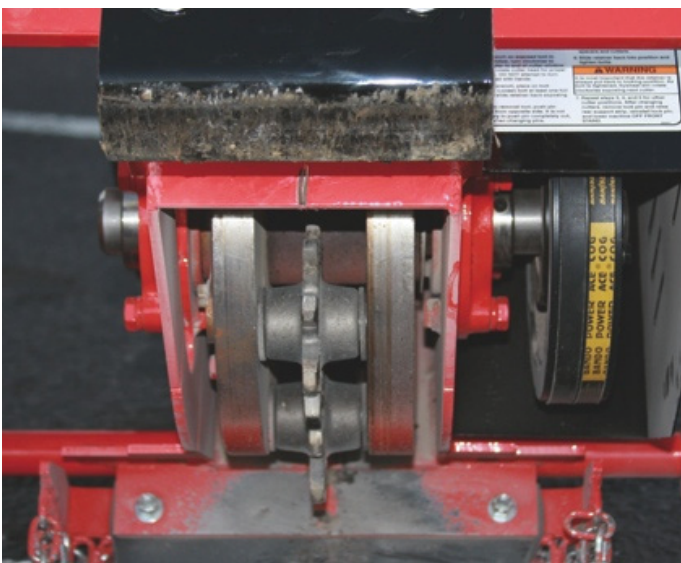

Photographs 4-5. Router head (left: courtesy Crafcro) and machine (right: courtesy Marathon Mfg.).

Table 4-2. Sawing versus routing (16).

	Diamond Saw	Rotary Impact Router
Operation	Small wide-diameter blade	Multiple impacting cutting heads
Cut Description	Smooth-walled reservoir	Rougher surface
Reservoir Description	More rectangular Higher % aggregate surface area	More maneuverable Follows cracks more closely
Production	Low 1.2 to 2.1 m/min	High 3.6 to 4.6 m/min
Maintenance		Faster blade wear

- types of cracks for consideration
 - longitudinal cracks
 - transverse cracks
 - edge cracks

Do Not Rout:

- crack opening less than 3 mm ($\frac{1}{8}$ ")
- fatigue cracks
- pavements with high-density cracking
- pavements being considered for rehabilitation

The router or saw width must touch both sides of the crack for proper cutting. It is recommended that the router remove $\frac{1}{8}$ " from each side of the crack and cut back to sound pavement. The minimum and maximum widths of the cut are recommended as $\frac{1}{2}$ " and 1- $\frac{1}{2}$ ", respectively, with a recommended cut depth of $\frac{3}{4}$ ". The pavement should not spall during the routing in order to obtain the best adhesion of the sealant to the crack edges (78).

When treating large cracks, backer rod is used to eliminate drainage of the sealant to the bottom of the crack. This allows better expansion and contraction of the sealant during cooling and heating and reduces the amount of sealant required, as shown in Graphic 4-4. If the sealant is placed too deep in the crack, the potential for cohesive failure is high. Almost 50% of the participants in the survey indicated that cohesive failure was frequently observed.



Graphic 4-4. Installation of backer rod (shown as an ellipse).

Crack Cleaning

The crack must be clean and dry prior to the placement of any sealant material. If this is not completed correctly, the sealant will not adhere to the sides of the crack and performance will be poor (adhesive failure). Lack of bond was the most common source of failure identified in the State-of-the-Practice Survey.

Best Practice suggests that the pavement should be swept to remove dirt and debris prior to starting crack treatment operations. A power sweeper or vacuum cleaner should be used, as shown in Photograph 4-6.

High-pressure air blasting should be used to remove dust, debris, and loose pavement fragments for both crack sealing and crack filling operations, as shown in Photograph 4-7. To accomplish this the compressor should have a minimum pressure of 100psi and a minimum blast flow



Photograph 4-6. Pavement sweeping (photo by Dale Decker).



Photograph 4-7. Compressed air cleaning of crack (courtesy Crafcfo).

of 150cfm (16, 21, 22). The compressed air must be free of oil and moisture to ensure that the sealant will adhere to the crack edges. A backpack blower (leaf blower) should not be used for crack cleaning. Almost 90% of the survey participants indicated that compressed air was used for crack cleaning. The compressed air cleaning should be directed away from passing traffic and should not blow debris into an already cleaned crack.

Crack vacuuming can also be performed to clean the crack. Photograph 4-8 shows a vacuum system cleaning the crack.

For crack filling, use of compressed air and/or vacuuming may be adequate, particularly if a cold-poured asphalt emulsion is to be used as the sealant. However, if crack sealing is to be done or if a hot-poured product is to be used for crack filling, the crack must be dried prior to sealant placement.



Photograph 4-8. Crack vacuum (courtesy Crafcfo).

Hot air lances are used to dry the crack, as shown in Photographs 4-9. Not only does the hot air lance dry the pavement, but it also warms the surface of the crack to enhance bonding of the sealant. A significant challenge for the hot air lance operator is to avoid overheating the asphalt mixture. Overheating can damage the asphalt binder and potentially weaken the crack edge.

There is no agreement in the technical literature regarding the temperature and velocity of the hot air lance, as are shown in Table 4-3. Temperatures range from about 1,000°F to 2,500°F, and velocities range from approximately 2,000 fps to 3,000 fps.

While there is disagreement about the specific operational characteristics, there is no disagreement that the hot air lance



Photographs 4-9. Hot air lances (left: courtesy Crafcfo, right: courtesy Lab Mfg.).

Table 4-3. Hot air lance temperature and velocity.

Agency	Hot Air Lance Temperature, °F	Hot Air Lance Air Velocity, fps
Michigan DOT (16)	2,500	1,970
Minnesota DOT (43)	1,800	3,000
Canadian Research Council (24)	932	(not specified)

is a valuable tool for crack sealing and should be used cautiously to avoid damage to the existing pavement. Appropriate safety gear should always be used.

Sandblasting has also been used to clean cracks. However, clean-up and environmental issues can be problematic. While sandblasting is effective, the cost is usually high so the process is seldom used.

Material Preparation

The manufacturer of every sealant provides handling and heating recommendations for the specific product. The recommendations must be followed. Issues such as melting recommendations, minimum placement temperature, heating temperatures, and guidelines for length of heating time to avoid overheating will typically be included in the recommendations. Improperly handling the material, particularly overheating, may result in significantly different material properties for some sealants, affecting both application and performance of the material. The user must know and follow the recommendations from the manufacturer. In addition, the manufacturer is required to provide Material Safety Data Sheets (MSDS) for each product. All personnel should be familiar with the MSDS requirements for safe handling.

For crack sealing installation to proceed, the sealant must be brought to application temperature. For hot-poured sealant, the material must be heated to proper application temperature. For cold-poured sealant, the sealant will have minimal if any heat applied to the material.

It is recommended that the melter for hot-poured applications be a self-contained double boiler device with the transmittal of heat through heat transfer oil to the sealant vessel. Direct-fired melters are used in some areas, but with the sealants commonly used today, there is a considerable concern for damage to the sealant. Direct-fired melters are not considered Best Practice for polymer modified crack sealants.

The melter equipment from three manufacturers is illustrated in Photographs 4-10 to 4-12. The melter must be equipped with an on-board automatic heat-controlling device to achieve and maintain the proper sealant temperature for the proper installation of material. The melter must be capable of safely heating product to 400°F. The temperature control should not allow the heat transfer oil to exceed 525°F. There should be temperature readings of the sealant within the melting vessel and



Photograph 4-10. SealMaster melter (courtesy SealMaster).



Photograph 4-11. Marathon melter (courtesy Marathon Manufacturing).



Photograph 4-12. Loading Crafcro melter (courtesy Crafcro).

within the discharge plumbing to provide monitoring of the sealant throughout the operation (81).

The unit shall also have a means to vigorously and continuously agitate the sealant that meets requirements of ASTM D6690. Extreme caution must be used when charging the sealant into the melter to avoid injury to the operator. The sealant should be applied to the pavement under pressure supplied by a gear pump with a direct connecting applicator tip (81).

The melters are manufactured with different size melting chambers for use on jobs of different sizes. Some melter models allow two operators to be working at the same time, thereby greatly increasing productivity.

Sealant Installation

For cold-poured crack filling applications, if the sealant is an emulsion, it can be placed in the crack using a gravity feed system or something as simple as a cone, as shown in Photograph 4-13. Gravity feed systems are used in some areas but are not considered Best Practice. It is difficult to get the sealant into the crack, and a significant amount of sealant is wasted on the surface (82).

After installation of the crack treatment, it may be necessary to apply a blotter material to minimize tracking by traffic. Sand, toilet paper, and commercial products have all been used as blotting material. Photograph 4-14 (a) illustrates a sand blotter being applied, (b) illustrates use of toilet paper, and (c) illustrates a spray-on application of anti-tracking solution (sprayer on right side of photo). While the sand and paper will serve as a blotter, there is debris created because of the residue generated. There is also a potential for the toilet paper to be mistaken for lane markings on longitudinal cracks.

For hot-poured applications, the conditions at the time of installation are critical to the success of the treatment. Graphic 4-5 illustrates the wrong times for crack sealing (SS-1). If sealant is applied in the winter when the crack is wide, the sealant will be squeezed out of the crack in the summer when the crack is narrower, as shown in row one of the graphic. The middle row of the graphic demonstrates that if

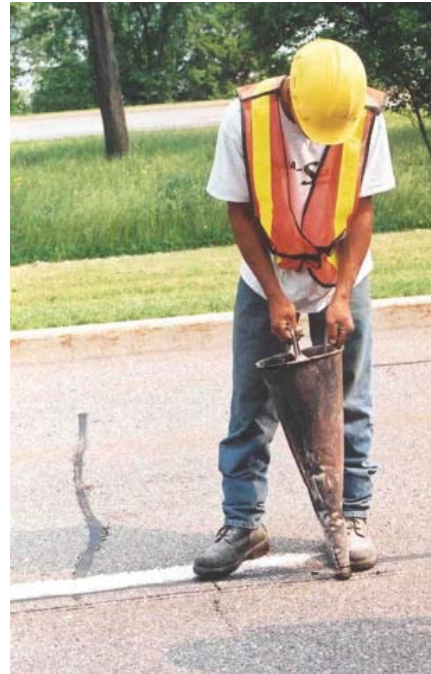

Photograph 4-13. Application of emulsion crack treatment (24).

the crack is sealed in the summer, there is a risk for cohesive failure in the sealant during the winter when the crack width is at its highest value. The final row of the graphic illustrates that spring and fall are optimum times for crack sealing in order to get best performance of the sealant.

It is noted that the survey respondents indicated the average crack sealing season is May to August, which for many areas in North America may not be considered optimum timing for crack treatment installation. Since a significant percentage of crack treatment is done with agency personnel, the decision on timing possibly depends on availability of personnel rather than on performance of the crack treatment.

It is not recommended to apply hot-poured sealants over cold patches (22). The sealant may cause failure of the cold patch.



Photographs 4-14. Blotter applications: (a) Sand blotter (16), (b) Toilet paper (16), (c) Anti-tracking solution (photo by Dale Decker).

Winter & Summer NOT the Right Time for Joint and Crack Sealing

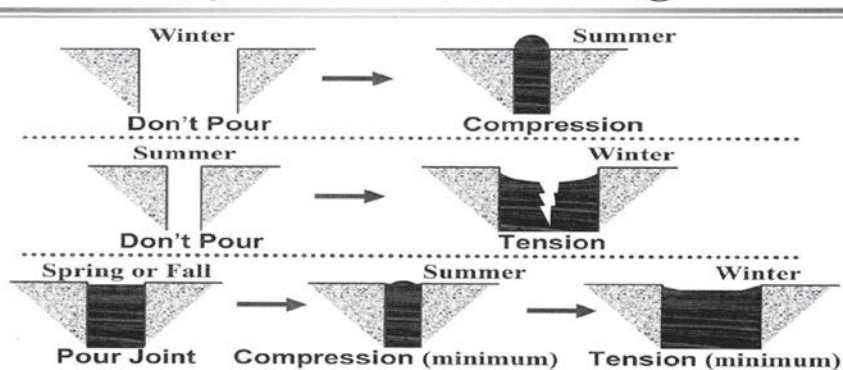

Graphic 4-5. Not the right time for crack treatment (SS-1).

Safety

It is important for all sealant crewmembers to understand safety requirements for handling the sealants and the equipment being used. Sealant and equipment manufacturers provide recommended safe operating procedures for their products. The following PPE is recommended for application of sealants:

- Long pants;
- Long-sleeved shirt buttoned at the wrists;
- Heat-resistant gloves;
- Eye protection (safety glasses or face shield);
- Hard-soled work shoes; and
- Traffic safety vests and hard hats (when exposed to traffic).

Photograph 4-15 illustrates proper protection for workers involved in crack treatment applications. Basically, all skin should be covered to prevent a potential burn from skin contact with the hot sealant. If skin contact does occur, cool



Photograph 4-15. Crack treatment operations (21).

the affected area with cool water or compounds specifically designed for asphalt removal—do not attempt to remove the material from skin either mechanically or with solvents. Once cool, the sealant will fall off the affected skin in a few days. In addition, good safety practices include the availability of a fire extinguisher, a first aid kit, and burn packs.

Quality Control

For most construction operations, inspection of the work performed is an integral part of the construction process. The survey responses indicated that inspection is generally not performed during crack sealing operations even though participants reported better performance of the crack treatment if an inspector is present. Inspection of the crack treatment installation is important regardless of the personnel performing the work. In order to optimize performance of the sealant, verification of the quality of the work is critical.

Some agencies have used warranty contracts to relieve the owner of inspection responsibility. Since 60% of the survey respondents indicated that crack treatments are performed with in-house personnel, a warranty contract model cannot be used effectively for a substantial portion of the crack treatments installed under current practices.

Masson et al. (24) discussed an inspection method for evaluating the efficiency of the routing procedure. A metal die was developed (Graphic 4-6) that enables the inspector to measure the rout depth and width. Minnesota DOT (43) uses a square die to inspect routed cracks.

Included in the inspector's duties are verification of:

- Proper sealant for the project;
- Proper equipment for the project;
- Inspection of the equipment to be used;
- Proper equipment operation;
- Equipment calibration;

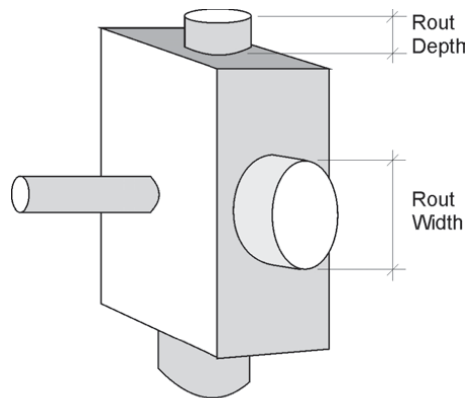

Graphic 4-6. Metal die for QC of routing depth and width (24).

- Temperature of the melter;
- Sample sealant for specification testing;
- Proper crack cleaning and routing (if used);
- Proper sealant installation;
- Usage of proper PPE; and
- Safe workzone.

In addition, the inspector can maintain a professional diary of project activities.

Inspection of the work performed is a critical need for crack treatment operations.

Montana DOT published the Troubleshooting guide found in Table 4-4 (5). This guide provides good insight into issues that may be encountered.

Table 4-4. Troubleshooting crack treatment issues (5).

Problem Encountered	Possible Causes	Possible Solutions
Bubbles in Sealant	Damaged backer rod	Change backer rod installation method or rod diameter
	Wrong backer rod	Use proper backer rod for hot-poured sealants
	Moisture in crack Grass or weeds in crack	Dry reservoir
	Bubbles in melter	Add sealant Reduce agitator speed
	Moisture present	Slowly heat to evaporate water
	Air trapped by sealant	Fill reservoir from bottom
Sealant is deeply sunken in reservoir	Crack is underfilled Rod is slipping into crack No rod present	Use proper sealant volume Use proper rod diameter
Sealant surface is not consistent	Operator control is poor Operator movement is uneven Reservoir width/depth is variable Inconsistent material temperature	Use nozzle with depth control plate Use wand with shutoff at nozzle Use an experienced operator
Sealant not sticking to routed reservoir walls	Reservoir walls are not clean	Remove all contaminants
	Moisture on walls from rain, dew, or condensation	Wait for pavement to dry Use hot air lance Use compressor with moisture trap
	Sealant temperature too low	Maintain recommended sealant temperature
	Pavement temperature too low	Wait until it warms up
	Incompatibility of sealant and asphalt mix	Use proper formulation
Sealant remains tacky after installation	Melter is contaminated with heat transfer oil, solvent, or other sealant	Empty and clean melter
	Sealant has been overheated or heated too long	Empty melter and replace with fresh sealant Check melter temperature regularly

Conclusion

The primary focus of crack treatments is to achieve a pavement maintenance application that will perform well under a variety of environmental and traffic conditions. As with most pavement construction activities, there are many, many details that must be given attention. Crack treatments are no exception to that statement.

The state-of-the-art review highlighted areas in which the state-of-the-practice has not kept up with current technology. This is all too easy to happen. People applying crack treatments have learned how to do the job mainly by experience. As a result, it is often challenging to implement new technology.

Based on the results of this project, areas in which improvements in the state-of-the-practice should be considered include:

- Evaluation of pavement condition prior to sealant application—i.e., what type of crack is present, how severe is the cracking, and what is the density of the cracking;
 - Acceptance of the new SG evaluation system;
 - Proper preparation of the crack prior to sealant application—making sure that the crack is clean, dry, and properly configured for the application;
 - Training for sealant application personnel—this is an ongoing need;
 - Quality Control testing for sealant products—establishment of uniform sampling and testing protocols;
 - Inspection of the crack treatment operations—many agencies do little if any inspection of the treatment work; and
 - Evaluation of sealant performance—understanding how the sealant performs enables the owner to make knowledgeable decisions about materials and procedures.
-

Bibliography

1. McDonald, T., and McDonald, P., "How to Crackseal Effectively," for Construction Pros.com, February 2012.
2. Zubeck, H., Liu, J., and Mullin, A., "Pavement Preservation Practices in Cold Regions," University of Alaska Anchorage and University of Alaska Fairbanks, FHWA-AK-RD-12-17, 2012.
3. Orr, D. P., "Pavement Maintenance," Cornell Local Roads Program, Ithaca, NY, CLRP No. 06-5, 2006.
4. Best Practices Handbook on Asphalt Pavement Maintenance, Chapter 4: Crack Treatments, Minnesota T²/LTAP, Minnesota Department of Transportation, and Minnesota Local Road Research Board, Manual 2000-04, 2000.
5. Crack Seal Manual, Montana Department of Transportation.
6. Technical Circular T-1-99, Crack Sealing Asphalt Pavements, British Columbia Ministry of Transport, 1999.
7. Project Scoping Manual, Chapter 5: Signs of Pavement Distress and Fix Selection Guidelines, Michigan Department of Transportation, 2013.
8. Al-Qadi, I. L., Masson, J. F., Yand, S. H., Fini, E., and McGhee, K. K., "Development of Performance-Based Guidelines for Selection of Bituminous-Based Hot-Poured Pavement Crack Sealant: An Executive Summary Report," Virginia Transportation Research Council, FHWA-VTRC 09-CR7, 2009.
9. Walubita, L. F., Faruk, A. N. M., Alvarez, A. E., Izzo, R., Haggerty, B., and Scullion, T., "Laboratory HMA Cracking Testing: Evaluation of Three Repeated Loading Crack Tests," Transportation Research Board, 2013.
10. Amador-Jimenez, L., "Pavement Management: Capturing Surface Treatment Effectiveness," Transportation Research Board, 2013.
11. Yi, J., Feng, D., Yang, S.-H., and Yu, F., "A Preliminary Analysis on Determination of Optimum Crack Sealing Time for Asphalt Pavement," Transportation Research Board, 2013.
12. Shuler, S., "Short-Term Crack Sealant Performance and Reducing Bumps and Transverse Cracking in New Hot Mix Asphalt Overlays over Crack Sealants," Final Report, CDOT-2009-9, Colorado Department of Transportation, 2009.
13. Lynch, L. N., Chehovits, J. G., Luders, D. G., and Belangie, M., "Twenty One Year Field Performance of Joint Resealing Project at Fairchild AFB," Transportation Research Board, 2013.
14. Crack Sealing and/or Crack Filling Project Selection Guide, Connecticut Department of Transportation, 2011.
15. Al-Qadi, I. L., Loulizi, A., Aref, S., Masson, J.-F., and McGhee, K. M., "Modification of Bending Beam Rheometer Specimen for Low-Temperature Evaluation of Bituminous Crack Sealants," Transportation Research Board, 2005.
16. Reay, S., Appleyard, M., Van Dam, T., and Sandberg, L. B., "Sealing and Filling of Cracks for Bituminous Concrete Pavements: Selection and Installation Procedures," Michigan Technological University in cooperation with Michigan Department of Transportation, 1999.
17. Symons, M., "Sealing and Filling Cracks in Asphalt Pavements," TechBrief, Federal Highway Administration, Washington, D.C., 1999.
18. Chehovits, J., and Galehouse, L., "Energy Usage and Greenhouse Gas Emissions of Pavement Preservation Processes for Asphalt Concrete Pavements," First International Conference on Pavement Preservation, Chapter 1: Paper 65, Institute of Transportation Studies, University of California, Richmond, CA, 2010.
19. Brown, E. R., "Preventative Maintenance of Asphalt Concrete Pavements," Transportation Research Board, 1988.
20. Li, F., Shi, X., Zeng, W., and Xu, J., "Laboratory Evaluation and Field Investigation of Asphalt Pavement Crack Seal Band," Transportation Research Board, 2013.
21. Yildirim, Y., Qatan, A., and Prozzi, J., "Field Manual For Crack Sealing in Asphalt Pavements," Research Project 0-4061-P3, Center for Transportation Research, University of Texas at Austin, 2006.
22. Crack Treatment, Chapter 4, Maintenance Technical Advisory Guide, California Department of Transportation, Sacramento, California, 2009.
23. Eaton, R. A., and Ashcraft, J., "State-of-the-Art Survey of Flexible Pavement Crack Sealing Procedures in the United States," Cold Regions Research and Engineering Laboratory Report 92-18, Hanover, New Hampshire, 1992.
24. Masson, J.-F., Boudreau, S., and Girard, C., "Guidelines for Sealing and Filling Cracks in Asphalt Concrete Pavement: A Best Practice by the National Guide to Sustainable Municipal Infrastructure," Federation of Canadian Municipalities and National Research Council, Canada, 2003.
25. Recommended Performance Guideline for Crack Treatment, ISSA A175, International Slurry Surfacing Association, Annapolis, MD, 2012.
26. Hicks, R. G., Dunn, K., and Moulthrop, J. S., "Framework for Selecting Effective Preventative Maintenance Treatments for Flexible Pavements," Transportation Research Record 1597, Transportation Research Board, Washington, D.C., 1997.
27. Carter, S., Ksaibati, K., and Huntington, G., "Field and Laboratory Evaluations of Hot-Poured Thermoelastic Bituminous Crack Sealing of Asphalt Pavements," Transportation Research Record 1933, Transportation Research Board, Washington, D.C., 2005, pp. 113–120.
28. Eltahan, A. A., Daleiden, J. F., and Simpson, A. L., "Effectiveness of Maintenance Treatments of Flexible Pavements," Transportation

- Research Record 1680, Transportation Research Board, Washington, D.C., 1999, pp. 18–24.
29. Cook, J. P., and Lewis, R. M., “Evaluation of Pavement Joint and Crack Sealing Materials and Practices,” National Cooperative Highway Research Program Report 38, Transportation Research Board, Washington, D.C., 1967.
 30. Johnson, D. R., Freeman, R. B., and Stevenson, J. R., “Cost-Effectiveness of Crack Sealing Materials and Techniques for Asphalt Pavements,” Transportation Research Record 1697, Transportation Research Board, Washington, D.C., 2000.
 31. Masson, J. F., and Lacasse, M. A., “A Review of Adhesion Mechanisms at the Crack Sealant/Asphalt Concrete Interface,” Durability of Building and Construction Sealants, National Research Council of Canada, Canada, 2000, pp. 259–274.
 32. Tighe, S. L., and Gransberg, D., “Sustainable Pavement Maintenance and Preservation Practices: A Review of Current Practice,” Transportation Research Board, Washington, D.C., 2013.
 33. Ponniah, J., and Kennepohl, G. J., “Crack Sealing in Flexible Pavements: A Life-Cycle Cost Analysis,” Transportation Research Record 1529, Transportation Research Board, Washington, D.C., 2007.
 34. Ponniah, J., “Crack Sealing in Flexible Pavements: A Life-Cycle Cost Analysis,” Report PAV-92-04, Ontario Ministry of Transport, Downsview, Ontario, Canada, 1992.
 35. Chong, G. J., and Phang, W. A., “Improved Preventative Maintenance: Sealing Cracks in Flexible Pavements in Cold Regions,” Transportation Research Record 1205, Transportation Research Board, Washington, D.C., 1988.
 36. Chehovits, J., and Manning, M., “Materials and Methods for Sealing Cracks in Asphalt Concrete Pavements,” Transportation Research Record 990, Transportation Research Board, Washington, D.C., 1984.
 37. Chong, G. J., “Rout and Seal Cracks in Flexible Pavement—A Cost-Effective Preventative Maintenance Procedure,” Transportation Research Record 1268, Transportation Research Board, Washington, D.C., 1990.
 38. Wang, C.-P., and Weisgerber, F. E., “Effects of Seal Geometry on Adhesive Stresses in Pavement Joint Seals,” Transportation Research Record 1392, Transportation Research Board, Washington, D.C., 1993.
 39. Masson, J. F., and Lacasse, M. A., “Effect of Hot-Air Lance on Crack Sealant Adhesion,” *Journal of Transportation Engineering*, Vol. 125, No. 4, 1999, pp. 357–363.
 40. Masson, J. F., Lauzier, C., Collins, P., and Lacasse, M. A., “Sealant Degradation during Crack Sealing of Pavements,” *Journal of Materials in Civil Engineering*, 1998, pp. 250–255.
 41. Smith, K. L., Peshkin, D. G., Rmeili, E. H., Van Dam, T., and Darter, M. I., “Innovative Materials and Equipment for Pavement Surface Repairs, Volume 1: Summary of Material Performance and Experimental Plans,” SHRP-M/UFR-91-504, Strategic Highway Research Program, National Research Council, Washington, D.C., 1991.
 42. Hand, A. J., Galal, K. A., Ward, D. R., and Fang, C., “Cost-Effectiveness of Joint and Crack Sealing: Synthesis of Practice,” *Journal of Transportation Engineering*, Vol. 126, No. 6, pp. 521–529, 2000.
 43. Recommended Practices for Crack Sealing HMA Pavement, LRRB 822 Project 822, Minnesota Department of Transportation, 2008.
 44. “Use of Crack Sealing Prior to Placement of Hot Mix Asphalt,” Technical Bulletin, Flexible Pavements of Ohio, Columbus, OH.
 45. Yildirim, Y., Qatun, A., and Kennedy, T. W., “Performance Evaluation of Hot and Cold Pour Crack Sealing Treatments,” FHWA/TX-03-4061-2, Center for Transportation Research, University of Texas at Austin, 2004.
 46. Yildirim, Y., Korkmaz, A., and Prozzi, J., “Performance Comparison of Hot Rubber Crack Sealants to Emulsified Asphalt Crack Sealants,” FHWA/TX-06/0-4061-3, Center for Transportation Research, University of Texas at Austin, 2006.
 47. Ram, P. V., and Peshkin, D. G., “Performance and Benefits of Michigan DOT’s Capital Preventive Maintenance Program,” Submitted for publication, Transportation Research Board, Washington, D.C., 2014.
 48. Abernathy, C., “Evaluation of Crack-Sealing Milled Pavement in the Effort to Reduce Transverse Cracking,” Annual Report 2013, Montana Department of Transportation, 2013.
 49. Crack Seal Application, Pavement Preservation Checklist Series, FHWA-IF-02-005, Federal Highway Administration and Foundation for Pavement Preservation, Washington, D.C., 2001.
 50. Application Note: Using LTPPbind V.2.1 to Improve Crack Sealing in Asphalt Concrete Pavements, FHWA-RD-03-080, Federal Highway Administration, Washington, D.C., 2003.
 51. Farrar, M. J., Hajj, E. Y., Planche, J. P., and Alavi, M. Z., “A Method to Estimate the Thermal Stress Build-up in an Asphalt Mixture from a Single-Cooling Event,” *Road Materials and Pavement Design*, Vol. 14, No. S1, pp. 201–211, Taylor and Francis, London, England, 2013.
 52. TechBrief: 4-mm DSR, Western Research Institute, Laramie, Wyoming.
 53. Smith, K. L., and Romine, A. R., “Materials and Procedures for Sealing and Filling Cracks in Asphalt-Surfaced Pavements—Manual of Practice,” FHWA Report No. FHWA-RD-99-147, Federal Highway Administration, Washington, D.C., 1999.
 54. Peshkin, D. G., Hoerner, T. E., and Zimmerman, K. A., “Optimal Timing of Pavement Preventative Maintenance Applications,” Report 523, National Cooperative Highway Research Program, Transportation Research Board, Washington, D.C., 2004.
 55. Chan, S., Lane, B., and Kazmierowski, T., “Pavement Preservation—A Solution for Sustainability,” Proceedings, Annual Conference of Transportation Association of Canada, 2010.
 56. Masson, J. F., Woods, J. R., Collins, P., and Al-Qadi, I. L., “Accelerated Aging of Bituminous Sealants: Small Kettle Aging,” *International Journal of Pavement Engineering*, Volume 9, #5, 2008, pp. 365–371.
 57. Tons, E., “A Theoretical Approach to Design of a Road Joint Seal,” HRB 229, Highway Research Board (now Transportation Research Board), Washington, D.C., 1959, pp. 20–53.
 58. Schutz, R. J., “Shape Factor in Joint Design,” *Civil Engineering Magazine*, SF 232, October 1962.
 59. Galehouse, L., Moulthrop, J. S., and Hicks, R. G., “Principles of Pavement Preservation: Definitions, Benefits, Issues, and Barriers,” TRNews 228, Transportation Research Board, Washington, D.C., 2003.
 60. Peterson, D. E., “Resealing Joints and Cracks in Rigid and Flexible Pavements,” Synthesis 98, National Cooperative Highway Research Program, Transportation Research Board, Washington, D.C., 1982.
 61. Gee, K. W., Preventative Maintenance Eligibility Memorandum, Federal Highway Administration, Washington, D.C., 2004.
 62. Geiger, D. R., Action Pavement Preservation Definitions Memorandum, Federal Highway Administration, Washington, D.C., 2005.
 63. Ponniah, J., “Field Evaluation of Rout and Seal Crack Treatment in Flexible Pavements,” Report PAV-90-03, Ontario Ministry of Transport, Downsview, Ontario, Canada, 1990.
 64. Khuri, M. F., and Tons, E., “Comparing Rectangular and Trapezoidal Seals Using the Finite Element Method,” Transportation

- Research Record 1334, Transportation Research Board, Washington, D.C., 1992, pp. 25–37.
65. Wilde, W. J., and Johnson, E. N., “Effect of Crack Sealant Material and Reservoir Geometry on Surface Roughness of Bituminous Overlays,” Submitted to Transportation Research Board for 2009 Annual Meeting, Washington, D.C.
 66. Marquart, M., “Evaluation of Crafcro Crack Sealant on Asphalt Pavements,” First Annual Report, Project H-5-085(004)041, North Dakota Department of Transportation, 1997.
 67. Hozayen, H., Ponniah, J., and Svec, O., “Laboratory Evaluation of Pavement Crack Routing and Sealing Preventative Maintenance,” Transportation Research Board, Washington, D.C., 1995.
 68. Halayko, L. B., “A Comparative Study of the Effects of Runway De-Icers on Crack Sealants,” Project Report, University of Manitoba, Department of Civil and Geological Engineering, 1994.
 69. Fer, E., and Kavanagh, L., “2004–2006 Joint and Crack Sealant Evaluation Report,” Manitoba Transportation and Government Service, 2006.
 70. Smith, K. L., and Romine, A. R., “LTPP Pavement Maintenance Materials: SHRP Crack Treatment Experiment, Final Report,” FHWA-RD-99-143, Federal Highway Administration, Washington, D.C., 1999.
 71. Harder, I., “Rubberized Crack Seal Performance in North Peace District,” British Columbia Ministry of Transportation and Highways, 1997.
 72. Filice, J., “Study of Crack Sealant Products (Routing and Sealing),” ABRT/RD/TM-05/02, Alberta Transportation, Edmonton, Alberta, Canada, 2003.
 73. McNichol, D., “Paving the Way: Asphalt in America,” National Asphalt Pavement Association, Lanham, Maryland, 2005.
 74. Al-Qadi, I. L., Ozer, H., and Yousefi, S. S., “Performance-Based Grading System for Hot-Poured Crack Sealant,” Webinar, Transportation Research Board, Washington, D.C., 23 October 2012.
 75. Equipment Operations Safety Manual, Crafcro, Inc., Chandler, Arizona, 2003.
 76. Funk and Wagnalls Standard Dictionary, J. G. Ferguson Publishing Company, Chicago, Illinois, 1978.
 77. Fournier, P., “Feds Push More Use of Pavement Preservation,” Associated Construction Publications, February 2009.
 78. Application Instructions: Hot-Applied Roadsaver, Polyflex, Parking Lot and Asphalt Rubber Products, Crafcro, Inc., Chandler, Arizona, 2002.
 79. Chehovits, J. G., “Cracks in AC Pavements,” Presentation at National Pavement Preservation Conference, Nashville, Tennessee, 2012.
 80. Miller, J. S., and Bellinger, W. Y., “Distress Identification Manual for the Long-Term Pavement Performance Program” (Fourth Revised Edition), FHWA-RD-03-031, Federal Highway Administration, Washington, D.C., 2003.
 81. Kelly, N. T., Personal Communication with Dale S. Decker regarding equipment requirements for crack sealing operations, Crafcro, Inc., 2013.
 82. Pavement Maintenance Manual, Nebraska Department of Roads.
 83. Field Sampling from Melters Procedure, Crafcro, Inc., Chandler, Arizona, 2008.
 84. Al-Qadi, I. I., Ozer, H., Yousefi, S. S., and McGhee, K. K., “Validation of Hot-Poured Crack Sealant Performance-Based Guidelines,” Illinois Center for Transportation Research, 2014.
 2. Work Performance Standard: Mainline Crack Filling, Code 2070, Indiana Department of Transportation, Division of Maintenance, 2013.
 3. Standard Operating Guideline (SOG 402-1), Tennessee Department of Transportation Division of Maintenance, 2010.
 4. Plant Mix Pavement Crack Sealing, Section 403, Standard Specifications, Wyoming Department of Transportation.
 5. Crack Sealing Hot-Mix Asphalt Pavement, Section 451, Standard Specifications, Illinois Department of Transportation.
 6. Peoria County, Illinois, Request for Quotations for Crack Sealing, 2013.
 7. Crack Sealing for Roadways, Section 02501, Martin County, Florida, 2012.
 8. Joint Repair and Crack Filling Maintenance Standard, Arkansas State Highway and Transportation Department, 2007.
 9. Master Agreement for Polymer Asphalt Cracksealing, Commonwealth of Kentucky, 2011.
 10. Project Provisions and Specifications for Supply or Supply and Deliver Crack Fill Material in Yavapai County, Arizona, 2013.
 11. Project Provisions and Specifications for Contract for Crack Sealing in Yavapai County, Arizona, 2013.
 12. HMA Crack Treatment, Section 502, Standard Specifications, Michigan Department of Transportation.
 13. HMA Crack Treatment and Overband Crack Fill, Special Provision 12SP502(B), Michigan Department of Transportation.
 14. Warranty Work Requirements for HMA Crack Treatment (Capital Preventative Maintenance), Special Provision 12SP502(A), Michigan Department of Transportation.
 15. Bituminous Pavement Crack Treatment, Special Provision SP2005 S-136, Minnesota Department of Transportation, 2008.
 16. Bituminous Pavement Crack Treatment Clean and Seal, Special Provision SP2005 S-137, Minnesota Department of Transportation, 2008.
 17. Pavement Crack Sealing, Section 536, Standard Specifications for Highway Construction, British Columbia Highways, Canada, 2004.
 18. Crack and Joint Cleaning and Sealing (HMA Surfaces), Section 2541, Iowa Department of Transportation.
 19. Cleaning and Filling Cracks for HMA Surfaces, Section 2544, Iowa Department of Transportation.

Test Methods (TM)

1. Standard Method of Test for Accelerated Aging of Bituminous Sealants and Fillers with a Vacuum Oven, AASHTO TP 86-10, American Association of State Highway and Transportation Officials, Washington, D.C.
2. Standard Method of Test for Evaluation of the Low-Temperature Tensile Property of Bituminous Sealants by Direct Tension Test, AASHTO TP 88-10, American Association of State Highway and Transportation Officials, Washington, D.C.
3. Standard Method of Test for Measuring Interfacial Fracture Energy of Hot-Poured Crack Sealant Using a Blister Test, AASHTO TP 90-10, American Association of State Highway and Transportation Officials, Washington, D.C.
4. Standard Method of Test for Measure Low Temperature Flexural Creep Stiffness of Bituminous Sealants and Fillers by Bending Beam Rheometer (BBR), AASHTO TP 87-10, American Association of State Highway and Transportation Officials, Washington, D.C.
5. Standard Adhesion of Hot-Poured Crack Sealant Using Direct Adhesion Tester, AASHTO TP 89-10, American Association of State Highway and Transportation Officials, Washington, D.C.
6. Standard Practice for Evaluating the Performance of Crack Sealing Treatments on Asphalt Surfaced Pavement, PP20-95, American

State Specifications (SS)

1. Work Performance Standard: Mainline Crack Route and Seal, Code 2090, Indiana Department of Transportation, Division of Maintenance, 2013.

- Association of State Highway and Transportation Officials, Washington, D.C., reconfirmed 2000.
7. Standard Method of Test for Apparent Viscosity of Hot-Poured Crack Sealant Using Brookfield Rotational Viscometer RV Series Instrument, AASHTO TP 85-10, American Association of State Highway and Transportation Officials, Washington, D.C.
 8. Standard Practice for Melting of Hot-Applied Joint and Crack Sealant and Filler for Evaluation, ASTM D5167-13, Volume 04.03, American Society for Testing and Materials, West Conshohocken, Pennsylvania, 2013.
 9. Standard Specification for Backer Material for Use with Cold- and Hot-Applied Joint Sealants in Portland-Cement Concrete and Asphalt Joints, ASTM D5249-10, Volume 04.03, American Society for Testing and Materials, West Conshohocken, Pennsylvania, 2013.
 10. Standard Test Methods for Sealants and Fillers, Hot-Applied, for Joints and Cracks in Asphaltic and Portland Cement Concrete Pavements, ASTM D5329-09, Volume 04.03, American Society for Testing and Materials, West Conshohocken, Pennsylvania, 2013.
 11. Standard Specification for Joint and Crack Sealants, Hot Applied, for Concrete and Asphalt Pavements, ASTM D6690-12, Volume 04.03, American Society for Testing and Materials, West Conshohocken, Pennsylvania, 2013.
 12. Standard Specification for Emulsified Asphalt, ASTM D977-12b, Volume 04.03, American Society for Testing and Materials, West Conshohocken, Pennsylvania, 2013.
 13. Standard Specification for Cationic Emulsified Asphalt, ASTM D2397-12, Volume 04.03, American Society for Testing and Materials, West Conshohocken, Pennsylvania, 2013.
-

Abbreviations and acronyms used without definitions in TRB publications:

A4A	Airlines for America
AAAAE	American Association of Airport Executives
AASHO	American Association of State Highway Officials
AASHTO	American Association of State Highway and Transportation Officials
ACI-NA	Airports Council International-North America
ACRP	Airport Cooperative Research Program
ADA	Americans with Disabilities Act
APTA	American Public Transportation Association
ASCE	American Society of Civil Engineers
ASME	American Society of Mechanical Engineers
ASTM	American Society for Testing and Materials
ATA	American Trucking Associations
CTAA	Community Transportation Association of America
CTBSSP	Commercial Truck and Bus Safety Synthesis Program
DHS	Department of Homeland Security
DOE	Department of Energy
EPA	Environmental Protection Agency
FAA	Federal Aviation Administration
FHWA	Federal Highway Administration
FMCSA	Federal Motor Carrier Safety Administration
FRA	Federal Railroad Administration
FTA	Federal Transit Administration
HMCRP	Hazardous Materials Cooperative Research Program
IEEE	Institute of Electrical and Electronics Engineers
ISTEA	Intermodal Surface Transportation Efficiency Act of 1991
ITE	Institute of Transportation Engineers
MAP-21	Moving Ahead for Progress in the 21st Century Act (2012)
NASA	National Aeronautics and Space Administration
NASAO	National Association of State Aviation Officials
NCFRP	National Cooperative Freight Research Program
NCHRP	National Cooperative Highway Research Program
NHTSA	National Highway Traffic Safety Administration
NTSB	National Transportation Safety Board
PHMSA	Pipeline and Hazardous Materials Safety Administration
RITA	Research and Innovative Technology Administration
SAE	Society of Automotive Engineers
SAFETEA-LU	Safe, Accountable, Flexible, Efficient Transportation Equity Act: A Legacy for Users (2005)
TCRP	Transit Cooperative Research Program
TEA-21	Transportation Equity Act for the 21st Century (1998)
TRB	Transportation Research Board
TSA	Transportation Security Administration
U.S.DOT	United States Department of Transportation