

## Cost-Effective and Sustainable Road Slope Stabilization and Erosion Control

### DETAILS

---

70 pages | 8.5 x 11 | PAPERBACK

ISBN 978-0-309-22362-1 | DOI 10.17226/22776

### AUTHORS

---

Fay, Laura; Akin, Michelle; and Shi, Xianming

BUY THIS BOOK

FIND RELATED TITLES

### Visit the National Academies Press at [NAP.edu](http://NAP.edu) and login or register to get:

---

- Access to free PDF downloads of thousands of scientific reports
- 10% off the price of print titles
- Email or social media notifications of new titles related to your interests
- Special offers and discounts



Distribution, posting, or copying of this PDF is strictly prohibited without written permission of the National Academies Press. (Request Permission) Unless otherwise indicated, all materials in this PDF are copyrighted by the National Academy of Sciences.

**NATIONAL COOPERATIVE HIGHWAY RESEARCH PROGRAM**

---

---

**NCHRP SYNTHESIS 430**

---

---

**Cost-Effective and Sustainable Road Slope  
Stabilization and Erosion Control**

***A Synthesis of Highway Practice***

**CONSULTANTS**

LAURA FAY

MICHELLE AKIN

and

XIANMING SHI

Western Transportation Institute

Montana State University

Bozeman, Montana

**SUBSCRIBER CATEGORIES**

Environment • Highways • Maintenance and Preservation

---

Research Sponsored by the American Association of State Highway and Transportation Officials  
in Cooperation with the Federal Highway Administration

---

**TRANSPORTATION RESEARCH BOARD**

WASHINGTON, D.C.

2012

[www.TRB.org](http://www.TRB.org)

## NATIONAL COOPERATIVE HIGHWAY RESEARCH PROGRAM

Systematic, well-designed research provides the most effective approach to the solution of many problems facing highway administrators and engineers. Often, highway problems are of local interest and can best be studied by highway departments individually or in cooperation with their state universities and others. However, the accelerating growth of highway transportation develops increasingly complex problems of wide interest to highway authorities. These problems are best studied through a coordinated program of cooperative research.

In recognition of these needs, the highway administrators of the American Association of State Highway and Transportation Officials initiated in 1962 an objective national highway research program employing modern scientific techniques. This program is supported on a continuing basis by funds from participating member states of the Association and it receives the full cooperation and support of the Federal Highway Administration, United States Department of Transportation.

The Transportation Research Board of the National Research Council was requested by the Association to administer the research program because of the Board's recognized objectivity and understanding of modern research practices. The Board is uniquely suited for this purpose as it maintains an extensive committee structure from which authorities on any highway transportation subject may be drawn; it possesses avenues of communication and cooperation with federal, state, and local governmental agencies, universities, and industry; its relationship to the National Research Council is an insurance of objectivity; it maintains a full-time research correlation staff of specialists in highway transportation matters to bring the findings of research directly to those who are in a position to use them.

The program is developed on the basis of research needs identified by chief administrators of the highway and transportation departments and by committees of AASHTO. Each year, specific areas of research needs to be included in the program are proposed to the National Research Council and the Board by the American Association of State Highway and Transportation Officials. Research projects to fulfill these needs are defined by the Board, and qualified research agencies are selected from those that have submitted proposals. Administration and surveillance of research contracts are the responsibilities of the National Research Council and the Transportation Research Board.

The needs for highway research are many, and the National Cooperative Highway Research Program can make significant contributions to the solution of highway transportation problems of mutual concern to many responsible groups. The program, however, is intended to complement rather than to substitute for or duplicate other highway research programs.

---

**NOTE:** The Transportation Research Board of the National Academies, the National Research Council, the Federal Highway Administration, the American Association of State Highway and Transportation Officials, and the individual states participating in the National Cooperative Highway Research Program do not endorse products or manufacturers. Trade or manufacturers' names appear herein solely because they are considered essential to the object of this report.

## NCHRP SYNTHESIS 430

Project 20-05 (Topic 42-09)

ISSN 0547-5570

ISBN 978-0-309-22362-1

Library of Congress Control No. 2012934386

© 2012 National Academy of Sciences. All rights reserved.

## COPYRIGHT INFORMATION

Authors herein are responsible for the authenticity of their manuscripts and for obtaining written permissions from publishers or persons who own the copyright to any previously published or copyrighted material used herein.

Cooperative Research Programs (CRP) grants permission to reproduce material in this publication for classroom and not-for-profit purposes. Permission is given with the understanding that none of the material will be used to imply TRB, AASHTO, FAA, FHWA, FMSCA, FTA, or Transit development Corporation endorsement of a particular product, method, or practice. It is expected that those reproducing the material in this document for educational and not-for-profit uses will give appropriate acknowledgment of the source of any development or reproduced material. For other uses of the material, request permission from CRP.

## NOTICE

The project that is the subject of this report was a part of the National Cooperative Highway Research Program conducted by the Transportation Research Board with the approval of the Governing Board of the National Research Council. Such approval reflects the Governing Board's judgment that the program concerned is of national importance and appropriate with respect to both the purposes and resources of the National Research Council.

The members of the technical committee selected to monitor this project and to review this report were chosen for recognized scholarly competence and with due consideration for the balance of disciplines appropriate to the project. The opinions and conclusions expressed or implied are those of the research agency that performed the research, and, while they have been accepted as appropriate by the technical committee, they are not necessarily those of the Transportation Research Board, the National Research Council, the American Association of State Highway and Transportation Officials, or the Federal Highway Administration of the U.S. Department of Transportation.

Each report is reviewed and accepted for publication by the technical committee according to procedures established and monitored by the Transportation Research Board Executive Committee and the Governing Board of the National Research Council.

*Published reports of the*

## NATIONAL COOPERATIVE HIGHWAY RESEARCH PROGRAM

*are available from:*

Transportation Research Board  
Business Office  
500 Fifth Street, NW  
Washington, DC 20001

*and can be ordered through the Internet at:*  
<http://www.national-academies.org/trb/bookstore>

Printed in the United States of America

# THE NATIONAL ACADEMIES

## *Advisers to the Nation on Science, Engineering, and Medicine*

The **National Academy of Sciences** is a private, nonprofit, self-perpetuating society of distinguished scholars engaged in scientific and engineering research, dedicated to the furtherance of science and technology and to their use for the general welfare. On the authority of the charter granted to it by the Congress in 1863, the Academy has a mandate that requires it to advise the federal government on scientific and technical matters. Dr. Ralph J. Cicerone is president of the National Academy of Sciences.

The **National Academy of Engineering** was established in 1964, under the charter of the National Academy of Sciences, as a parallel organization of outstanding engineers. It is autonomous in its administration and in the selection of its members, sharing with the National Academy of Sciences the responsibility for advising the federal government. The National Academy of Engineering also sponsors engineering programs aimed at meeting national needs, encourages education and research, and recognizes the superior achievements of engineers. Dr. Charles M. Vest is president of the National Academy of Engineering.

The **Institute of Medicine** was established in 1970 by the National Academy of Sciences to secure the services of eminent members of appropriate professions in the examination of policy matters pertaining to the health of the public. The Institute acts under the responsibility given to the National Academy of Sciences by its congressional charter to be an adviser to the federal government and, on its own initiative, to identify issues of medical care, research, and education. Dr. Harvey V. Fineberg is president of the Institute of Medicine.

The **National Research Council** was organized by the National Academy of Sciences in 1916 to associate the broad community of science and technology with the Academy's purposes of furthering knowledge and advising the federal government. Functioning in accordance with general policies determined by the Academy, the Council has become the principal operating agency of both the National Academy of Sciences and the National Academy of Engineering in providing services to the government, the public, and the scientific and engineering communities. The Council is administered jointly by both Academies and the Institute of Medicine. Dr. Ralph J. Cicerone and Dr. Charles M. Vest are chair and vice chair, respectively, of the National Research Council.

The **Transportation Research Board** is one of six major divisions of the National Research Council. The mission of the Transportation Research Board is to provide leadership in transportation innovation and progress through research and information exchange, conducted within a setting that is objective, interdisciplinary, and multimodal. The Board's varied activities annually engage about 7,000 engineers, scientists, and other transportation researchers and practitioners from the public and private sectors and academia, all of whom contribute their expertise in the public interest. The program is supported by state transportation departments, federal agencies including the component administrations of the U.S. Department of Transportation, and other organizations and individuals interested in the development of transportation. [www.TRB.org](http://www.TRB.org)

[www.national-academies.org](http://www.national-academies.org)

## NCHRP COMMITTEE FOR PROJECT 20-05

### CHAIR

CATHERINE NELSON  
*Oregon DOT*

### MEMBERS

KATHLEEN S. AMES

*Michael Baker, Jr., Inc.*

STUART D. ANDERSON

*Texas A&M University*

BRIAN A. BLANCHARD

*Florida DOT*

CYNTHIA J. BURBANK

*PB Americas*

LISA FREESE

*Scott County (MN) Community Services Division*

MALCOLM T. KERLEY

*Virginia DOT*

RICHARD D. LAND

*California DOT*

JOHN M. MASON JR.

*Auburn University*

ROGER C. OLSON

*Minnesota DOT*

ROBERT L. SACK

*New York State DOT*

FRANCINE SHAW-WHITSON

*Federal Highway Administration*

LARRY VELASQUEZ

*JAVEL Engineering, Inc.*

### FHWA LIAISONS

JACK JERNIGAN

MARY LYNN TISCHER

### TRB LIAISON

STEPHEN F. MAHER

**Cover figure:** A road shoulder shallow slope stabilization project using the “deep patch” treatment with several layers of Geogrid reinforcement. A joint project of the U.S. Forest Service and the Plumas County, California, Road Department (*courtesy:* G. Keller).

### ACKNOWLEDGMENTS

This report would not have been possible without the help of Gail Staba, and the input and guidance from project panel members. We would like to thank everyone who responded to our survey as well as those who participated in follow-up interviews and provided photographs, including Tiffany Allen, Vickie Bender, Chris Bennett, Pete Bolander, Jianje Chen, Xueping Chen, Paul Clark, Jeff Currey, Dr. Donald Gray, Jim Haang, Stuart Jennings, Byron Johnson, Kathy Kinsella, Chris Marr, Khalid Mohamed, David Orr, Dave Polster, Skip Ragsdale, Steve Romero, Warren Schlatter, Roger Skirrow, Robbin Sotir, David Steinfeld, Bob Vitale, and Stan Vitton. We would also like to thank the staff at the Western Transportation Institute for support on this project, specifically Andy Scott.

## COOPERATIVE RESEARCH PROGRAMS STAFF

CHRISTOPHER W. JENKS, *Director, Cooperative Research Programs*

CRAWFORD F. JENCKS, *Deputy Director, Cooperative Research Programs*

NANDA SRINIVASAN, *Senior Program Officer*

EILEEN P. DELANEY, *Director of Publications*

## SYNTHESIS STUDIES STAFF

STEPHEN R. GODWIN, *Director for Studies and Special Programs*

JON M. WILLIAMS, *Program Director, IDEA and Synthesis Studies*

JO ALLEN GAUSE, *Senior Program Officer*

GAIL R. STABA, *Senior Program Officer*

DONNA L. VLASAK, *Senior Program Officer*

TANYA M. ZWAHLEN, *Consultant*

DON TIPPMAN, *Senior Editor*

CHERYL KEITH, *Senior Program Assistant*

DEMISHA WILLIAMS, *Senior Program Assistant*

DEBBIE IRVIN, *Program Associate*

## TOPIC PANEL

ROBERT A. DOUGLAS, *Golder Associates, Inc., Mississauga, Ontario*

ASIF FAIZ, *World Bank (retired)*

ANTHONY R. GIANCOLA, *Washington, DC*

G.P. JAYAPRAKASH, *Transportation Research Board*

MICHAEL T. LONG, *Oregon Department of Transportation*

DAVID P. ORR, *Cornell University*

PATRICIA A. CAZENAS, *Federal Highway Administration, (Liaison)*

BEN RIVERS, *Federal Highway Administration, Atlanta (Liaison)*

GORDON KELLER, *Taylorsville, CA (Liaison)*

## FOREWORD

Highway administrators, engineers, and researchers often face problems for which information already exists, either in documented form or as undocumented experience and practice. This information may be fragmented, scattered, and unevaluated. As a consequence, full knowledge of what has been learned about a problem may not be brought to bear on its solution. Costly research findings may go unused, valuable experience may be overlooked, and due consideration may not be given to recommended practices for solving or alleviating the problem.

There is information on nearly every subject of concern to highway administrators and engineers. Much of it derives from research or from the work of practitioners faced with problems in their day-to-day work. To provide a systematic means for assembling and evaluating such useful information and to make it available to the entire highway community, the American Association of State Highway and Transportation Officials—through the mechanism of the National Cooperative Highway Research Program—authorized the Transportation Research Board to undertake a continuing study. This study, NCHRP Project 20–5, “Synthesis of Information Related to Highway Problems,” searches out and synthesizes useful knowledge from all available sources and prepares concise, documented reports on specific topics. Reports from this endeavor constitute an NCHRP report series, *Synthesis of Highway Practice*.

This synthesis series reports on current knowledge and practice, in a compact format, without the detailed directions usually found in handbooks or design manuals. Each report in the series provides a compendium of the best knowledge available on those measures found to be the most successful in resolving specific problems.

## PREFACE

*By Gail R. Staba,  
Senior Program  
Officer, Transportation  
Research Board*

In the United States it is estimated that 75% of all roads are low-volume roads maintained by some 35,000 local agencies. Low-volume roads often omit surface slope protection, and this can lead to slope failure, erosion, and maintenance, safety, and ecological issues. This report presents information on cost-effective and sustainable road slope stabilization techniques, with a focus on shallow or near-surface slope stabilization and related erosion control methods used on low-volume roads. To fully address this, topic planning and site investigation are discussed, as well as erosion control techniques, soil bioengineering and biotechnical techniques, mechanical stabilization, and earthwork techniques.

Information presented in this report was obtained through an extensive literature review, and from survey and interview responses. From the survey responses, 30 individuals were interviewed based on the information they made available in the survey. A total of 25 interviews were conducted over the phone, and in two cases written responses were received.

Laura Fay, Michelle Akin, and Xianming Shi, Western Transportation Institute, Montana State University, Bozeman, Montana, collected and synthesized the information and wrote the report. The members of the topic panel are acknowledged on the preceding page. This synthesis is an immediately useful document that records the practices that were acceptable within the limitations of the knowledge available at the time of its preparation. As progress in research and practice continues, new knowledge will be added to that now at hand.



## CONTENTS

- 1 SUMMARY
  
- 3 CHAPTER ONE INTRODUCTION
  - What Is Road Slope Stabilization?, 3
  - What Causes Instabilities?, 4
  - How Are Road Slopes Stabilized?, 4
  - How Is a Treatment Determined to Be Cost-Effective or Sustainable?, 5
  - Methods, 6
  
- 8 CHAPTER TWO THE BASICS
  - Planning and Site Investigation, 8
  - Soil Types and Soil Mechanics, 9
  - Water Management, 12
  - Drainage Measures, 12
  
- 19 CHAPTER THREE EROSION CONTROL TECHNIQUES
  - Types of Erosion, 19
  - Grass Seeding, 20
  - Mulch and Compost, 22
  - Erosion-Control Geotextiles, 23
  - Check Dams, 25
  - Wattles or Fiber Rolls, 27
  - Straw Bale Barriers, 27
  - Silt Fences, 28
  - Chemical Soil Stabilizers, 28
  
- 30 CHAPTER FOUR SOIL BIOENGINEERING AND BIOTECHNICAL TECHNIQUES
  - Planning for Soil Bioengineering, 30
  - Live Stakes, 32
  - Live Fascines, 33
  - Brush Layering and Palisades, 33
  - Branch Packing, 34
  - Rock Joint Planting, 35
  - Live and Timber Crib Walls, 36
  - Vegetated Rock Gabions, 37
  - Vegetated Rock Walls, 39
  
- 41 CHAPTER FIVE MECHANICAL STABILIZATION TECHNIQUES
  - Retaining Walls, 41
  - Mechanically Stabilized Earth/Geosynthetic Reinforced Soil Systems, 43
  - In-Situ Soil Reinforcement, 46
  
- 49 CHAPTER SIX EARTHWORK TECHNIQUES
  - Implementing Earthwork Techniques, 49
  - Benched Slopes, 49
  - Soil Roughening, 51
  - Extreme Roughening, 51



Flattening Slopes, 52

Landforming, Geomorphic Modification, 52

54 CHAPTER SEVEN CONCLUSIONS AND KNOWLEDGE GAPS

Conclusions, 54

Knowledge Gaps, 56

58 REFERENCES

65 APPENDIX A SURVEY QUESTIONS

68 APPENDIX B INTERVIEW QUESTIONS AND RESPONDENTS

70 APPENDIX C SLOPE RATIO VERSUS PERCENT SLOPE DIAGRAM

*Note:* Many of the photographs, figures, and tables in this report have been converted from color to grayscale for printing. The electronic version of the report (posted on the web at [www.trb.org](http://www.trb.org)) retains the color versions.

# COST-EFFECTIVE AND SUSTAINABLE ROAD SLOPE STABILIZATION AND EROSION CONTROL

**SUMMARY** In the United States and internationally, most roads are located in rural areas and have low traffic volumes. Worldwide, it is estimated that 88% of miles of road are low volume. In the United States it is estimated that 75% of miles of road are low volume, maintained by some 35,000 federal, state, and local agencies. Because low-volume roads often omit surface slope protection, they may be vulnerable to slope failure; erosion; and maintenance, safety, and ecological issues. This report presents information on cost-effective and sustainable road slope stabilization techniques, with a focus on shallow or near-surface slope stabilization and related erosion control methods used on low-volume roads. To fully address this topic, planning and site investigation are discussed along with erosion control techniques, soil bioengineering and biotechnical techniques, and mechanical stabilization and earthwork techniques.

The information presented in this report was obtained through an extensive literature review, and from survey and interview responses. Information gained from the literature review was used to develop a survey that gathered additional information from practitioners, scientists, contractors, and vendors on the current practices, effective practices, and emerging solutions being used regionally, nationally, or internationally. The survey was distributed by e-mail. Eighty-one survey responses were received. From the survey responses, 30 individuals were asked to be interviewed based on the information they made available in the survey. A total of 25 interviews were conducted over the phone, and in two cases written responses were received. Information gained from the literature review and the survey and interview responses was incorporated into this report as the body of the text, additional resources, references, erosion control and slope stabilization techniques and tools, current and effective management practices, useful points, photographs, and knowledge and research gaps.

Many techniques can be used to stabilize slopes, including several cost-effective and sustainable options. Every worksite is unique, and it is critical to understand the site-water, soil, and topography, as well as the user needs, before selecting an appropriate slope stabilization technique. To accomplish this, a full site assessment should be completed, one that provides information on the soil types and characteristics and surface and subsurface water conditions, and also takes into consideration short- and long-term planning. Developers should consider using a multidisciplinary team with a diverse knowledge and experience base. Techniques that are used frequently in planning for cost-effective roadway erosion control and soil stabilization include studying flora and fauna issues in the planning phase, considering the use of specific products, and clearly marking areas where the soil can be disturbed.

Appropriate water management through the development of a water management plan may be the key to preventing slope failures. Vegetation and mechanical structures can be used alone or in conjunction to stabilize slopes. When using vegetation to stabilize slopes, mulch and soil amendments can aid in on-site vegetation establishment. Saving and reusing topsoil and mulching with on-site materials are cost-effective and sustainable practices. Erosion control products could be considered for use at every site on any disturbed soil surface, as it is much easier to prevent erosion than to fix an already eroded slope. Methods

used to control surface erosion or stabilize slopes can be used alone or as components of a system. Mechanical slope stabilization methods can also be used alone or in conjunction with plants (biotechnical stabilization). Earthwork techniques can be used to make slope surface less likely to erode and more stable. (The conclusion provides tabular summaries of soil bioengineering and biotechnical, erosion control, mechanical, and earthworks stabilization techniques.)

The literature review, survey, and interviews identified the following knowledge and research gaps:

- A better understanding of erosion control and slope stabilization products' purpose and capabilities, and
- Cost-benefit analyses of products and techniques.

## CHAPTER ONE

**INTRODUCTION**

This report presents information on cost-effective and sustainable road slope stabilization techniques, with a focus on shallow or near-surface slope stabilization and related erosion control methods used on low-volume roads. Many of the identified solutions apply to higher volume roads as well. Specific items discussed in this report include the importance of soil and compost, the importance of having a surface and subsurface water management plan, soil bioengineering/biotechnical solutions, reinforced soil solutions, other vegetative and earthwork solutions, and appropriate erosion control measures to maximize the slope stabilization for a specific treatment.

In the United States and internationally, most roads are located in rural areas and have low traffic volumes. Worldwide, there are an estimated 21 million miles (33.8 million km) of roads, of which 18.6 million miles (30 million km) are rural, low-volume roads (Faiz 2011). In the United States, there are approximately 4 million miles (6.4 million km) in the road system, of which 3 million miles (4.8 million km) are rural, low-volume roads maintained by some 35,000 federal, state, and local agencies.

Low-volume roads often omit surface slope protection. This can lead to slope failure, erosion, and sedimentation, which contribute to water quality degradation and increased road maintenance demands, traffic delays, safety problems, damage to other resources, and, in the long term, reduction in the service life of roads. Soil erosion can cause flooding, increased water treatment costs, siltation of harbors and channels, loss of wildlife habitat, disruption of stream ecology, reduced recreational value, and adverse aesthetic impacts (Gray and Sotir 1996).

Erosion is the process of separating and transporting sediment by water, wind, or gravity. Removal of vegetation, disturbance of topsoil, compaction, and creation of steep slopes are among the many causes of erosion (Hayman and Vary 1999). Water erosion is the most damaging type of erosion, especially in developing areas, and erosion control is thus a particular concern for new construction. Erosion and the sedimentation it causes during and after highway construction can result in an unhealthy growing environment for vegetation, have negative impacts on adjacent waterways, and in the long run require additional maintenance (Johnson et al. 2003). In addition to reducing life-cycle repair and road maintenance costs,

other benefits of slope stabilization and erosion control are not always recognized. Those benefits include the following:

- Rural employment opportunities involving both skilled and unskilled labor;
- Low energy inputs;
- Protection of land and water resources;
- Preservation of local biodiversity (as native grass and plant species are used in bioremediation applications); and
- Aesthetically pleasing road sights.

Many slope stabilization solutions being implemented around the world by low-volume road engineers and managers are successful and cost-effective, but relevant information on methods and techniques is not well disseminated or widely used. In this context, a synthesis of effective practices is warranted. This work aims to compile available knowledge relevant to roadway slope stabilization and erosion control, with the primary audience being public road engineers and managers.

**WHAT IS ROAD SLOPE STABILIZATION?**

Road slope stabilization is the practice of stabilizing slopes adjacent to roads. Hundreds of effective road slope stabilization methods have been developed and used around the world. Road slope stabilization can range from allowing native grass to re-establish on a disturbed slope to building an engineered wall. The treatment measure depends on the affected area, cost, and feasibility. Royster (1982) found that treatment of one landslide may require extensive and immediate correction, while another slide may only require minimal control with periodic monitoring to achieve a similar level of service. Slope stabilization or erosion control requires a toolbox approach that considers the level of effectiveness and acceptability of the treatment. Site conditions and constraints can vary greatly, and a “one-size-fits-all” approach is unlikely to work. Instead, the right tools have to be selected for the specific project in light of its unique erosion and slope stabilization problems. Although seeding and constructing a rock wall are drastically different in terms of cost and sustainability, they are two tools in the toolbox and each has its place in road slope stabilization. The cost of slope stabilization and erosion control can range from minimal to astronomical. Field studies have shown that the

combined use of structural and vegetative slope protection systems is more cost-effective than the use of either method alone (Gray and Leiser 1982; Xu et al. 2006).

**WHAT CAUSES INSTABILITIES?**

Common causes and trigger events for erosion or soil instability include excessive slope angle or height, poor drainage, low-strength foundation, removal of vegetation that anchors soil, increased loading, environmental factors, poor handling of fill materials, high groundwater table, unsuitable geologic features, liquefaction, and wildfires (Shah 2008). Types of slope instabilities that can cause erosion include creep, fall or topple, slides, flow and spread, and settlement (Collin et al. 2008). Although triggers for landslides in transportation projects are often related to water (including intense rainfall, rapid snowmelt, water level changes, or stream erosion), slides can also be triggered by earthquakes, human activity, or volcanic eruptions (Collin et al. 2008).

Improper road construction techniques, including improper selection of equipment, are a common cause of slope instabilities (Shah 2008). One technique often used in mountainous regions is known as cut and cast, cut and fill, or side-cast construction. Side-cast fills are typically not compacted and not draining, and are oversteepened. Picture a road in a mountainous or hilly region where material has to be cut from the uphill side and cast onto the downhill side to create the road bench—the horizontal plane on which the road will be constructed. Figure 1 shows an idealized cross section of this technique in which the exact volume that was cut is perfectly cast adjacent to the cut. In reality, material is moved around to accommodate the actual shape of the hill or knob. For these roads, the cut-and-fill faces and fill portion, which are now steeper and disturbed, are areas of potential instability that could be treated. On flat ground, a raised road is often built with ditches to improve the drainage of water from the road (Figure 2). The created embankment may be prone to surface erosion if soil is left exposed.

Slope failures are the movement of soil, and they occur on both man-made and natural slopes. Potential causes for slope instability range from deep-seated failures (such as with landslides) to surface erosion (such as when steep slopes cause water to travel in concentrated flows, eroding a series of gullies). There are many types of slope failures, including rockfalls/rockslides, debris avalanches/debris flows, and slumps/earth flows (MSE 1997). Human-induced modifications that may adversely affect external loads to slopes include grading of the existing slope or adjacent slopes, construction adjacent to the slope, construction damage caused by blasting, and vibrations of passing vehicles (Turner and Schuster 1996). Slope regrading can create an oversteep toe, or base of the slope, or an accumulation of material at the crest, which can lead to erosion (Turner and Schuster 1996).

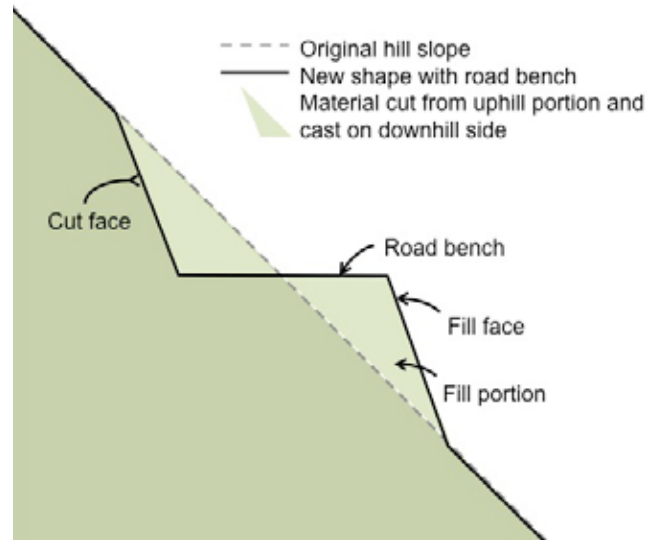

FIGURE 1 Cross section of typical (idealized) cut and fill construction with sidecast fill technique.

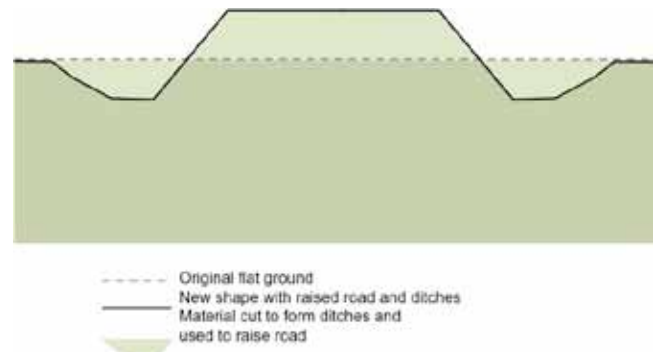

FIGURE 2 Cross section of a typical raised road with ditches created on both sides for drainage.

The shape of the slope can be a defining factor in its stability. Natural slopes are generally concave, which is the most stable type of slope and experiences the least erosion (Schor and Gray 2007). Many man-made slopes are linear (Schor and Gray 2007), and research has found that in many cases a linear slope will erode until it becomes concave (Gyasi-Agyei et al. 1996). Linear slopes created with benches are frequently used on larger slopes to reduce erosion potential, but modeling has found that linear slopes with contour benches tend to channel water in concentrated flow paths, causing severe gullying over time (Schor and Gray 2007).

**HOW ARE ROAD SLOPES STABILIZED?**

Consideration of surface slope protection and addressing surface water and groundwater issues during road construction and maintenance activities can reduce erosion and enhance the long-term performance of slopes and embankments. A combination of adequate drainage, installation of protective devices and elements, and establishment of desirable vegetation offers the best means for soil conservation.

For instance, seeding disturbed soil as areas of a project are completed can reduce erosion by 90% (Johnson et al. 2003).

There are dozens of techniques to stabilize road slopes and prevent surface erosion. *Erosion control* techniques generally protect the surface from being eroded by water and wind: examples include vegetative cover, crushed stone cover, mats, and blankets. The guiding principles are minimizing the exposed and disturbed areas and exposure time, managing on-site stormwater by reducing velocity and volume, installing erosion and sediment control measures early in the construction phase and during structural maintenance, and keeping sediment on site (Johnson et al. 2003). Temporary erosion control measures should be used during construction, especially when the construction occurs in steep rolling topography, in cases where most of the drainage enters directly into adjacent water bodies or wetlands, or where the subsoils are erosive (Alberta Transportation 2003). After projects are completed and vegetation is established, permanent measures should be implemented. Common devices for permanent erosion control include design elements, ditches and liners, riprap, soil bioengineering and biotechnical stabilization, and vegetation establishment. Many erosion problems could be avoided altogether with good design practices (Alberta Transportation 2003).

*Soil bioengineering* techniques utilize plant parts such as roots and stems to serve as structural and mechanical elements in slope protection systems (Gray and Sotir 1996; Sotir and McCaffrey 1997; Grace 2002; Fox et al. 2010). The plants act as soil reinforcement, aid in water drainage, or serve as barriers to earth movement (Gray and Sotir 1996). The use of sod, or native grass sod, as a best management practice (BMP) is compatible with highway revegetation prescriptions and is employed in several states (Dollhopf et al. 2008). Similarly, *biotechnical stabilization* utilizes structures in combination with plants to arrest and prevent slope failures and erosion with biological and mechanical elements functioning together in an integrated and complementary manner (Gray and Sotir 1996). Biotechnical stabilization applies to retaining structures, revetments, and ground cover systems (e.g., sod grass reinforced with netting) (Gray and Sotir 1996). Retaining structures to help hold back the slope include walls of various shapes and materials. The combined use of structural and vegetative elements (e.g., contour wattling, willow cuttings, conventional slope planting combined with low gabion walls, bench structures constructed at the toe of a slope, vegetation growth in the voids of structural walls) has been reported to be an attractive and cost-effective method to hold soil and prevent slope failures and erosion (Gray and Leiser 1980). Other options for stabilizing weak soils include stabilizing vegetation and structures, erosion control mats and mesh, and earthwork (e.g., terracing, anchoring, effective site drainage, slope modification), as well as the use of lime piles (Rogers et al. 2000), fibers and chemicals (RITA 2011), and electrochemical techniques (Wan and Mitchell 1976; Johnson and Butterfield 1977; Casagrande 1983; Alshahabkeh et al. 2004; Paczkowska

2005). Slope reinforcement can utilize vegetation, concrete, polymers, and other materials. Natural materials such as soil, rock, and timber are more environmentally compatible and are better suited to vegetative treatments or slight modification than are manufactured materials (USDA 1992). They may also be available on-site at no cost (USDA 1992).

*Mechanical stabilization techniques* utilize nonvegetative or nonliving components such as rock, gabion baskets, concrete, geosynthetics, and steel pins to reinforce slopes. These techniques can provide stability to both cut and fill slopes. Structures are generally capable of resisting much higher lateral earth pressures and shear stresses than vegetation (USDA 1992). Mechanical stabilization techniques include retaining walls, mechanically stabilized earth, geosynthetically reinforced soil, and other in-situ reinforcement techniques. For anchoring shallow soils, use of in-situ earth reinforcements and recycled plastic pins has been reported in slope stabilization (Pearlman et al. 1992; Loehr et al. 2000).

*Earthwork techniques* involve the physical movement of soil, rock, and/or vegetation for the purpose of erosion control and slope stabilization. This involves reshaping the surface slope by methods such as creating terraces or benches, flattening oversteepened slopes, soil roughening, or land forming. Earthwork techniques can be used to control surface runoff and erosion and sedimentation during and after construction (EPA 2008). Land grading can be used at sites with uneven or steep topography or on easily eroded soils to stabilize slopes, and terraces can be used to reduce sediment-laden runoff by slowing water flow down the slope, collecting and redistributing surface runoff into designed drainage channels (EPA 2008).

To effectively control soil instabilities and erosion, a systematic approach is needed that takes into account government regulations and permitting requirements; design, construction, and maintenance issues; various temporary and permanent control methods; and new technologies (Johnson et al. 2003). Although every slope stabilization treatment method can be considered a tool in the toolbox, some treatments may be more appropriate for a site. The current state of the practice has matured in such a way that practitioners no longer view specific slope stabilization treatments as good or bad, working or ineffective. Instead, a multidisciplinary approach that combines knowledge from multiple fields of study—including geology, hydrology, engineering, and landscape architecture—and combines treatment measures to create site-specific slope stabilization treatments is used to solve slope stabilization issues.

#### **HOW IS A TREATMENT DETERMINED TO BE COST-EFFECTIVE OR SUSTAINABLE?**

When considering road slope stabilization techniques for a site, there are generally many options. For example, on an

exposed road cut the treatment options may be (1) to build a retaining wall, (2) to build a vegetated crib wall, or (3) to add topsoil or compost to the eroding surface, hand seed the slope, and lay down erosion-control blankets. Any of these options could work well, but which one will be most cost-effective and sustainable?

The answer will depend on what is available on site, how much space is available to work with, and how much it costs to bring materials into the site.

When selecting a cost-effective, sustainable treatment for road slope stabilization, both the short- and long-term costs need to be considered. One way to ensure that a project is low cost and sustainable is to use local or on-site materials. Reusing on-site soil, rocks, tree stumps, downed trees, live vegetation, leaf litter, and the like can be very cost-effective. Use of on-site materials ensures that the project is sustainable by reducing fuel and transportation costs that would accrue if these materials needed to be brought to the site. Native seed stock present in the local soil is another benefit. In a survey conducted to gain information for this project, survey respondents stated that short- and long-term costs are considered important in deciding on a road slope stabilization and/or erosion control measure, and are frequently considered together.

A sustainable road slope stabilization treatment is one that disturbs the least amount of soil, keeps topsoil on site, reuses on-site vegetation to strengthen the slope, incorporates native plants, and poses minimal disturbance to the ecosystem. In a survey conducted to gain information for this project, 76% of survey respondents stated that they *always* or *frequently* consider how environmentally friendly or sustainable a road slope stabilization measure will be. Although many respondents stated that a strong sense of environmental stewardship has led them to make sustainable decisions, an equal number of respondents stated that local and state mandates, federal laws, and permit requirements weigh heavily in making a sustainable road slope stabilization treatment choice.

Aesthetic considerations are also often appropriate when choosing the stabilization technique. It is a common belief that created slope stabilization structures should fit with the natural landscape, and once the project is completed it is important that the site be restored as close to its previous condition as possible (Schiechl and Stern 1996). Issues include the balance and distribution of cut and fill material, the use of local building materials, the avoidance of deep and steep cuts into slopes wherever possible, and maintenance of the natural landscape.

## METHODS

This synthesis focuses on cost-effective and sustainable shallow (less than 10 ft) or near-surface slope stabilization

and related erosion-control treatments used on low-volume roads. An extensive literature review was conducted to gather information on cost-effective and sustainable near-surface slope stabilization techniques used on low-volume roads. Technical documents, government reports, journal publications, conference presentations and proceedings, and textbooks were used initially to identify pertinent information. Information was also sought from local, state, federal, and international governments and organizations; departments of transportation; manuals, field guides, and reports; published specifications; and organizations and companies that work to promote erosion control and slope stabilization. Information from the literature review was used to create the body of the report and the survey questions, and identify individuals and organizations for participation in the survey.

Based on information gained from the literature review, a survey was developed to gather additional information from practitioners, scientists, contractors, and vendors on current practices, effective practices, and emerging solutions that are used regionally, nationally, or internationally. The survey asked participants to provide identifying information, followed by seven questions requesting information on the respondents' direct experience with erosion control and slope stabilization techniques (Appendix A). The survey was distributed by e-mail to individuals identified in the literature review and by project panel members. The survey was available online for 2 months, and 81 responses were received. Survey responses were processed and summarized. Information identified in the survey that was incorporated into this report includes resources, references, erosion control and slope stabilization techniques and tools, best management practices, useful points, and photographs. Survey responses aided in focusing the synthesis on the most frequently used road slope stabilization techniques that are cost-effective and sustainable.

A list was compiled of survey respondents who indicated they were willing to participate in follow-up interviews. Thirty individuals were selected to be interviewed based on the information they made available in the survey. A total of 25 interviews were conducted, providing an 83% interview response rate. Interviews were conducted over the phone with the exception of two responses received through e-mail, owing to interviewees' location and language differences. Interviewees were asked 16 questions and instructed to provide responses based only on their direct experience (Appendix B). Interview responses were recorded with a digital recorder and then transcribed or recorded by hand during the interview process. Information gained from the interviews that was incorporated into this report includes additional resources, references, erosion control and slope stabilization techniques and tools, best management practices, useful points, photographs, knowledge gaps, and research needs.

The report begins with an introduction to the topic of cost-effective and sustainable road slope stabilization techniques. It defines road slope stabilization, identifies general techniques used to stabilize roads, and provides a discussion of the terms cost-effective and sustainable and how they relate to road slope stabilization treatments. This chapter also includes the methodology section, which outlines how the literature review, survey and interviews were conducted and provides an outline of the report. The following section on the basics provides information on planning and site investigation, soil type and mechanics, and water management including surface and subsurface drainage options. The next section, Erosion Control Techniques, defines erosion, outlines general causes, and provides examples of erosion control treatments and techniques, including seeding, mulching, the use of blankets, mats and geotextiles, check dams, wattles, silt fences, and chemical soil stabilizers. The Soil Bioengineering and Bio-technical Techniques section defines these two techniques and provides a review of treatments on the topic, including

the use of live stakes, fascines, crib walls, gabions, and rock walls in a combination of vegetation and structures to stabilize slopes. The next section, Mechanical Stabilization Techniques, defines this topic and provides information on retaining walls, mechanically stabilized earth and geosynthetically reinforced soil systems, geotextile walls, deep patch repairs, and in-situ soil reinforcement techniques. The Earthwork Techniques section defines this topic and provides information on benches, terraces, soil roughening, flattening over-steepened slopes, and land-forming. The report closes with a summary of findings from each section and a discussion of knowledge gaps and areas for future research.

The report resembles a guide in structure, but it is more appropriate to use it as a reference document. Each section highlights current cost-effective and sustainable practices in road slope stabilization. Each topic has an Additional Resources section that provides references from which more information can be gathered.



CHAPTER TWO

## THE BASICS

Good slope stabilization has three essential elements: proper planning and site investigation, understanding the soil, and knowing the surface and subsurface water conditions. This chapter summarizes literature and interview results on all three topics and provides additional resources for follow-up information.

### PLANNING AND SITE INVESTIGATION

When conducting slope stabilization work, it is more cost-effective to proactively apply appropriate techniques to control erosion, stabilize slopes, and maintain the site than to repair them after they have failed. A full assessment of the site should be completed before a slope stabilization technique is selected. The project plan developed by Howell (1999) for *Roadside Bio-engineering: Site Handbook* is a good example of how to develop a successful slope stabilization implementation plan (Table 1). Howell (1999) suggests that planning occur over at least 1 year, if possible, and that time be allowed in the second year following construction for site monitoring and maintenance.

It is widely recognized that the more front-end work one can do to understand the site, the more likely it is that the best possible treatment will be selected. During the initial planning stages, one should think broadly at the watershed level and consider topography, geography, geology, and so on. It may be helpful to consult historical rainfall and snowfall records for the site, geologic maps, nearby slope stability, records on previous work completed at the site, and previous work above and below the slope. Changes to construction practices may be necessary to allow for longer maintenance periods. Consider using a multidisciplinary team of soil scientists, botanists, geologists, hydrologists, ecologists, landscape architects, and

geotechnical engineers to gain further information about the site characteristics. The aim of the site investigation is to (1) recognize actual or potential slope movements and (2) identify the type and cause of the movement (Turner and Schuster 1996). This information will help in selecting the most appropriate prevention and correction strategy.

When starting a site investigation, the following five items need to be defined:

- **Purpose** of the site or road;
- **Scope** of the site, including topography, geology, ground-water, weather, and slope history;
- Extent of the project or **area** of the work site;
- **Depth** of the instability and/or stable support layer; and
- **Duration** of the project (Turner and Schuster 1996).

Signs of slope instability may include slumped soil (Figure 3); tension cracks; eroded material at the base of the slope (Figure 4); hummocky and broken or uneven terrain; leaning trees (Figure 5); water seeps, ponds, or channels; or other signs of surface erosion.

### Useful Points

- In the planning phase, consider the timing of each project component (S. Jennings, personal communication, April 12, 2011).
- At the planning level, consider all options and keep a broad focus (S. Romero, personal communication, May 11, 2011).
- Consider using experienced engineers and contractors (B. Johnson, personal communication, April 18, 2011).
- Know the areas of expertise of potential contractors (S. Romero, personal communication, May 11, 2011).

TABLE 1  
STEPS TO IMPLEMENT BIOENGINEERING

Planning	Design	Implementation	Maintenance
<ul style="list-style-type: none"> <li>• Initial work plan</li> <li>• Prioritize work</li> <li>• Divide site into segments and assess</li> <li>• Determine engineering and bioengineering techniques to be used</li> </ul>	<ul style="list-style-type: none"> <li>• Design engineering and bioengineering techniques</li> <li>• Select species</li> <li>• Calculate quantities, rates, and finalize budget</li> <li>• Plan for plant needs</li> <li>• Arrange for implementation and required documents/permits</li> </ul>	<ul style="list-style-type: none"> <li>• Prepare for plant propagation</li> <li>• Make site arrangements</li> <li>• Implement engineering and bioengineering techniques</li> <li>• Monitor work</li> </ul>	<ul style="list-style-type: none"> <li>• Maintain site</li> </ul>

Source: Howell (1999).

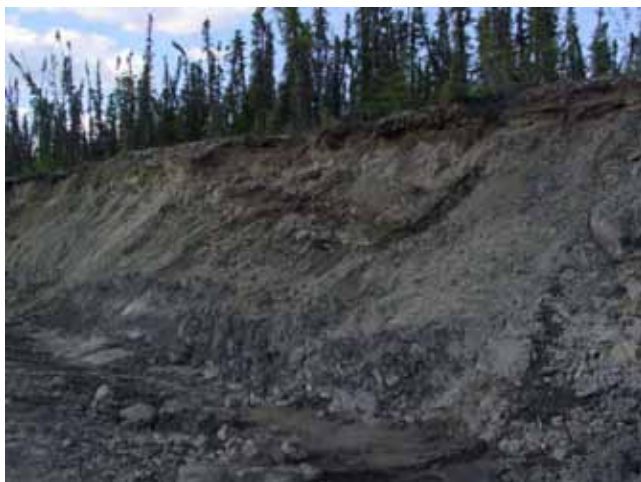

FIGURE 3 Unstable slope caused by freeze–thaw cycles in Alaska (Courtesy: J. Currey).



FIGURE 4 Shallow cut failure just below grass root depth. Use deep-rooted vegetation for slope stabilization (Courtesy: G. Keller).



FIGURE 5 Slumped slope with leaning trees (Courtesy: G. Keller).

- Consider using an experienced project manager on site who can coordinate efforts and operations for all

aspects of the project (K. Mohamed, personal communication, April 26, 2011).

- Consider conducting a life cycle analysis for all treatments before they are used (A. Faiz, personal communication, May 6, 2011).
- Every project is unique, and each treatment needs to be tailored to the site (A. Faiz, personal communication, May 6, 2011).
- Talk with knowledgeable local personnel to understand the types and nature of problems in that area (G. Keller, personal communication, April 26, 2011).

#### Additional Resources for Planning and Site Investigation

Adams, P.W. and C.W. Andrus, “Planning Secondary Roads to Reduce Erosion and Sedimentation in Humid Tropic Steeplands,” In *Proceedings of Research Needs and Applications to Reduce Erosion and Sedimentation in Tropical Steeplands, Fiji Symposium*, IAHS-AISH Publ. No. 192, June 1990.

Clayton, C.R.I., N.E. Simons, and M.C. Matthews, *Site Investigation: A Handbook for Engineers*, Halsted Press, New York, N.Y., 1982.

Ethiopia Roads Authority, *Design Manual for Low Volume Roads Part A, B and C*, Final Draft, Apr. 2011 [Online]. Available: <http://www.dfid.gov.uk/r4d/PDF/Outputs/AfCap/Design-Manual-for-Low-Volume-Roads-Part-A.pdf>.

Howell, J., *Roadside Bio-engineering: Site Handbook*, His Majesty’s Government of Nepal, Ganabahal, Kathmandu, 1999 [Online]. Available: <http://onlinepubs.trb.org/Onlinepubs/sp/Airport/RoadsideBioengineering.pdf>.

Hunt, R.E., *Geotechnical Engineering Investigation Handbook*, CRC Press, LLC, Boca Raton, Fla., 2005.

Hearn, G.J. and R.W. Weeks, *Principles of Low Cost Road Engineering in Mountainous Regions*, with special reference to Nepal, Himalaya, C.J. Lawrence, Ed., Transportation Research Library Overseas Road Note 16, Berkshire, United Kingdom, 1997.

Sara, M.N., *Site Assessment and Remediation Handbook*, CRC Press, LLC, Boca Raton, Fla., 2003.

Turner, K.A. and R.L. Schuster, Eds., *Special Report 247: Landslides Investigation and Mitigation*, National Academy Press, Washington, D.C., 1996.

#### SOIL TYPES AND SOIL MECHANICS

Soil mechanics is the study of the engineering behavior of soil under different stress conditions. The basic components of soil are soil particles (grains), water, and air. The rela-

tionship among these components provides several important index properties, such as density, moisture content, and degree of saturation. Other characteristics that are important for classifying the soil and engineering soil structures (including slopes) are index properties, such as grain size distribution, Atterberg limits (particularly the plastic and liquid limits), and soil shear strength.

Soil classification systems provide a means of grouping and identifying the expected behavior of soils. Laboratory tests for the grain size distribution, plastic limit, and liquid limit of a soil are used for classification within the Unified Soil Classification System (USCS), which is the most widely used system. The AASHTO soil classification system was originally developed to classify soils for assessing their suitability as a subgrade or pavement layer. There are significant differences between the USCS and AASHTO systems, but the AASHTO system is still commonly used by departments of transportation (DOTs) and pavement engineers (Holtz et al. 2011). Grain size distribution is determined by a sieve analysis for the coarse-grained fraction of soils (above No. 200 sieve with 0.075 mm opening size). If the size distribution of the fine-grained portion of soil is desired, a hydrometer is used. However, the more relevant property of the finer fraction of soils is plasticity index (PI). The plasticity index is the range in water content at which the soil behaves as a plastic solid. The PI is calculated from results of tests for the liquid limit and plastic limit of the finer portion (smaller than No. 40 sieve with 0.425 mm opening size) of the soil. Once the grain size distribution, plastic limit, and liquid

limit are known, the soil can be classified by USCS using ASTM 2487, Holtz and Kovacs (1981), Das (2007), Holtz et al. (2011), or any introductory geotechnical engineering or soil mechanics book. Figure 6 shows a few typical grain size distributions, and Table 2 provides typical compaction and drainage characteristics for USCS soil groups.

Soils fail in shear. If the shear stress is greater than the shear strength of the soil, it will fail. Thus, it is important to know the shear strength of soil. The strength properties of soil are described in terms of friction ( $\phi$ ) and cohesion ( $c$ ). These properties are determined from laboratory tests, such as the direct shear test and triaxial test. The triaxial laboratory test can be conducted under a variety of drainage conditions to provide parameters appropriate for drained and undrained analyses. Whether loading on soil could be thought of in terms of “drained” or “undrained” conditions depends on the permeability of the soil, the rate at which the load is applied, and the time period of interest (short or long term) after the load is applied (Holtz and Kovacs 1981; Duncan and Wright 2005).

- “Undrained signifies a condition where changes in loads occur more rapidly than water can flow in or out of the soil. The pore pressures increase or decrease in response to the changes in loads.
- Drained signifies a condition where changes in load are slow enough, or remain in place long enough, so that water is able to flow in or out of the soil, permitting the soil to reach a state of equilibrium with regard to water flow. The

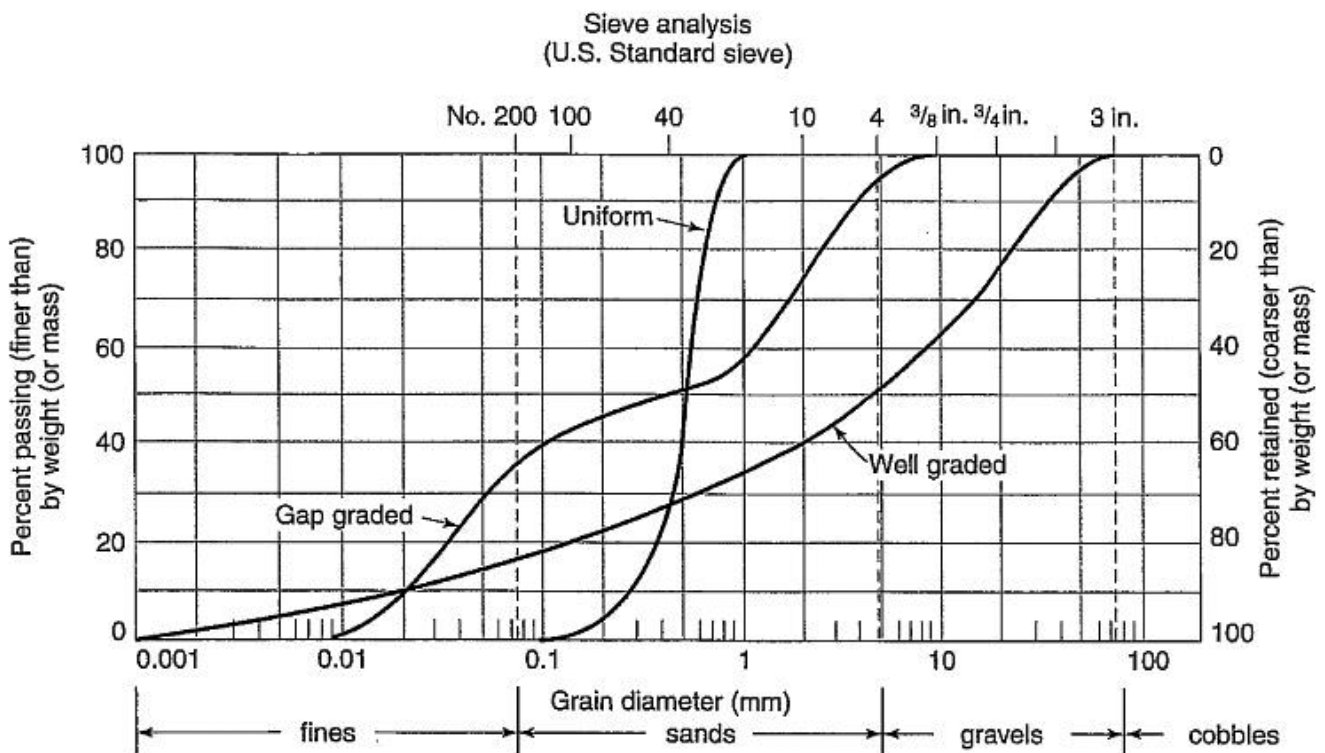

FIGURE 6 Three typical grain size distributions (Holtz et al. 2011).

TABLE 2  
USCS SOIL CLASSIFICATION AND TYPICAL PROPERTIES

USCS Soil Classification		Compaction Characteristics and Recommended Equipment	Drainage and Permeability	Value as an Embankment Material
Group Symbol	Group Name			
GW	Well-graded gravel	Good: tractor, rubber-tired, steel wheel, or vibratory roller	Good drainage, pervious	Very stable
GP	Poorly graded gravel	Good: tractor, rubber-tired, steel wheel, or vibratory roller	Good drainage, pervious	Reasonably stable
GM	Silty gravel	Good: rubber-tired or light sheep's foot roller	Poor drainage, semipervious	Reasonably stable
GC	Clayey gravel	Good to fair: rubber-tired or sheep's foot roller	Poor drainage, impervious	Reasonably stable
SW	Well-graded sand	Good: tractor, rubber-tired or vibratory roller	Good drainage, pervious	Very stable
SP	Poorly graded sand	Good: tractor, rubber-tired or vibratory roller	Good drainage, pervious	Reasonably stable when dense
SM	Silty sand	Good: rubber-tired or sheep's foot roller	Poor drainage, impervious	Reasonably stable when dense
SC	Clayey sand	Good to fair: rubber-tired or sheep's foot roller	Poor drainage, impervious	Reasonably stable
ML	Silt	Good to poor: rubber-tired or sheep's foot roller	Poor drainage, impervious	Fair stability, good compaction required
CL	Lean clay	Good to fair: sheep's foot or rubber-tired roller	No drainage, impervious	Good stability
OL	Organic silt, Organic clay	Fair to poor: sheep's foot or rubber-tired roller	Poor drainage, impervious	Unstable, should not be used
MH	Elastic silt	Fair to poor: sheep's foot or rubber-tired roller	Poor drainage, impervious	Fair to poor stability, good compaction required
CH	Fat clay	Fair to poor: sheep's foot roller	No drainage, impervious	Fair stability, expands, weakens, shrinks, cracks
OH	Organic silt, Organic clay	Fair to poor: sheep's foot roller	No drainage, impervious	Unstable, should not be used
Pt	Peat	Not suitable	Should not be used	Should not be used

Source: NAVFAC (1986).

pore pressures in the drained condition are controlled by the hydraulic boundary conditions, and are unaffected by the changes in load” (Duncan and Wright 2005).

The fundamental requirement for a stable slope is that “the shear strength of the soil must be greater than the shear stress required for equilibrium” (Duncan and Wright 2005). Thus, factors that contribute to slope instabilities could be linked to decreases in shear strength and/or increases in shear stress. Duncan and Wright (2005) list the following processes responsible for these changes:

- Decreases in Shear Strength
  - Increased pore pressure (reduced effective stress)
  - Cracking
  - Swelling (increase in void ratio)
  - Development of slickensides
  - Decomposition of clayey rock fills
  - Creep under sustained loads
  - Leaching
  - Strain softening

- Weathering
- Cyclic loading.
- Increases in Shear Stress
  - Loads at the top of the slope
  - Water pressure in cracks at the top of the slope
  - Increase in soil weight resulting from increased water content
  - Excavation at the bottom of the slope
  - Drop in water level at the base of a slope
  - Earthquake shaking.

Geotechnical failures based on loss of shear strength are complex. For this reason, strongly encourage use of supplemental material referenced in the *Additional Resources for Soil Types and Mechanics*.

Water and the presence of clay minerals play a significant role in many of these processes, particularly those associated with decreases in shear strength.

The percentage of clay in a soil and the activity of clay minerals are reflected qualitatively by the value of the

plasticity index. For that reason PI affords a useful first indication of the potential for problems that a clayey soil poses: The higher the PI, the greater the potential for problems (Duncan and Wright 2005).

In addition to water, soil erosion may also be caused by wind. He et al. (2007) found that there is a linear relationship between the logarithm of the wind velocity and the intensity of resulting erosion. They also reported on the effectiveness of three practices in preventing wind erosion of highway slopes. In descending order of effectiveness, they were hexagonal bricks, arched frame beams, and mechanical compaction, with the relative soil loss ratio of such treated slopes at 0.35, 0.55, and 0.91, respectively.

In practical terms, the following conditions lead to instability:

- Slopes that are excessively steep or that have been undercut,
- Slopes that are wet or saturated,
- Poorly compacted fill slopes, and
- Steep slopes with shallow-rooted grasses that can be surcharged when saturated.

#### **Additional Resources for Soil Types and Mechanics**

Das, B.M., *Principles of Foundation Engineering*, 6th ed., Cengage Learning, Stamford, Conn., 2007.

Duncan, J.M. and S.G. Wright, *Soil Strength and Slope Stability*, John Wiley & Sons, Hoboken, N.J., 2005.

Holtz, R.D. and W.D. Kovacs, *An Introduction to Geotechnical Engineering*, Prentice-Hall, Inc., Upper Saddle River, N.J., 1981.

Holtz, R.D., W.D. Kovacs, and T.C. Sheahan, *An Introduction to Geotechnical Engineering*, 2nd ed., Pearson Education, Inc., Upper Saddle River, N.J., 2011.

#### **WATER MANAGEMENT**

“If you only look superficially, and don’t address the water problem by considering the overall site hydrology, you can miss finding an appropriate solution” (A. Faiz, personal communication, May 6, 2011).

Water management, in both cut and fill slopes, is important to protect the slopes from erosion and shallow depth instabilities resulting from increases in pore water pressure (GSPW 2003). Water may enter the roadway through cracks or surface defects on the road surface, or water can infiltrate through cuts and fills (Orr 1998). Capillary action may also draw moisture up from the water table, causing the road base to become satu-

rated and weakened. Construction of roads may also modify the surface and subsurface flow pattern of water, causing no flow or reduced flow in some natural channels but concentrated flow in others (Shrestha and Manandhar 2010).

In general, water management measures in slopes consist of surface and subsurface drainages that transport water to natural drainages safely and as quickly as possible (GSPW 2003). Roadway drainage is the control of water within the road, including moving water off the road surface and removing excess subsurface water that would infiltrate the road base and subgrade (Orr 1998). To understand how to manage water at each site rainfall, topography, catchment area, ground surface conditions, soil parameters, groundwater conditions, and existing natural and artificial drainage systems should be studied and assessed to determine the required drainage solution (Turner and Schuster 1996). If necessary, a combination of both surface and subsurface drains can be used to manage surface and groundwater conditions (GSPW 2003).

For each site, a water management plan should answer the following questions:

- Where is the water source?
- Where does the water come to the surface?
- How is the water interacting with the different soil and rock types?
- Is an artificial drainage system needed for the slope?
- Can vegetation alter the hydrology and improve slope stability?

A good water management plan will include conservation of natural systems that interact with the road, which can be considered in the design and construction phases (Shrestha and Manandhar 2010). Examples include adding rolling dips and low-water fords that follow natural topography, and using bridges and surface stabilization as needed (Adams and Andrus 1990).

#### **DRAINAGE MEASURES**

Drainage of water from the road surface has significant implications for slope stability and can affect water quality, erosion, and road costs (Keller and Sherar 2003). Poorly drained pavements and slopes adjacent to roads can cause premature deterioration and lead to costly repairs and replacements (Cedergren 1989). The following drainage issues should be addressed in road design and construction:

- Roadway surface drainage;
- Control of water in ditches and at pipe inlets and outlets;
- Crossings of natural stream channels;
- Wet area crossings;
- Subsurface drainage; and



- Selection and design of culverts, low-water crossings, and bridges.

Before surface and subsurface drainage measures are installed, drainage conditions and patterns should be studied. Specific observation could be made during rainy periods to monitor flow patterns, identify areas where ponding occurs, assess potential damage, and determine preventive measures that can be used to minimize damage and to keep the drainage system functioning properly (McCuen et al. 2002).

Good water drainage begins in the design and construction phases of road building. Road surfaces should be shaped appropriately to keep water from accumulating on the road surface. Standing water should be avoided, as it often creates or worsens potholes, ruts, and sags (Keller and Sherar 2003). Drainage ditches should be constructed only when necessary. For example, a road graded away from a cut slope (an outsloped road) without ditches disturbs less ground and is less expensive to construct than an insloped or crowned road with drainage ditches, although the fill slope may require explicit erosion control measures (Moll et al. 1997). Keep water drainage from roads and streams disconnected by using water retention basins. When installing drainage structures, make sure that there is some rational or statistical assessment of the expected flow.

Howell (1999) offers the following advice for drainage design:

- Always design drainage systems to run along natural drainage lines.
- Choose locations for the drain so that the maximum effect can be achieved using the least amount of construction.
- Always ensure that the drain outlets are protected against erosion.
- Ensure that the foundation is sound, as with all civil structures.
- A flexible design is usually an advantage (e.g., concrete masonry, a rigid design, can be easily cracked by the slightest movement in the slope, resulting in leakage problems).
- Compact the backfill material thoroughly during construction.
- Apply appropriate bioengineering measures to enhance the effectiveness of the drain.

#### Useful Points

- On steep road grades, for example, greater than 12% to 15% (about 8:1), water becomes very difficult to control (Keller and Sherar 2003).

#### Surface Drainage

Surface drainage is most commonly accomplished by proper grading of the road surface or the use of structures to chan-

nel water from the road surface in a manner that minimizes effects to adjacent areas (Copstead et al. 1989). Surface drainage systems include drains, berm drains, toe drains, drainage channels, and cascades. U-shaped gutters (Figure 7), reinforced concrete (Figure 8), and corrugated half-pipe drains can also be used to construct drainage ditches (GSPW 2003). Surface water drains often use a combination of bioengineering and civil engineering structures (Howell 1999). Armor roadway ditches and leadoff ditches with rock riprap (Figure 9), masonry, concrete lining, geotextiles, and/or grasses to protect highly erosive soils (Keller and Sherar 2003). Ditch dike structures can also be used to dissipate energy and control ditch erosion. If ditch erosion is occurring, the best solution may be to place additional cross-drains to disperse and reduce the amount of water that is causing the erosion.

There are three main ditch shapes: V, U, and trapezoid. Each can be filled or lined (Orr 1998). V-shaped ditches are the easiest to construct; however, the bottom of the V is prone to erosion and can be difficult to maintain. U-shaped or rounded ditches are more efficient hydraulically than V-shaped ditches, are more desirable for erosion control, and are easy to maintain. Trapezoid, or flat-bottomed, ditches are the most efficient hydraulically and can be used for ditches that carry heavier flows. The flat bottom of the trapezoid ditch helps reduce erosion problems and spread water flow. Ditches may be filled or lined and will act similarly to trench drains. An example of a filled ditch that behaves as a trench drain would be lining a ditch with large stone and placing a perforated pipe at the bottom of the ditch. Ditches can be lined with native earth, geotextiles, grass, stone, and/or concrete. (Orr 1998). Lining the roadside ditch with geotextiles can reduce erosion rates. Ditches require cleaning, which entails the removal of sediment and vegetation from the bottom of the ditch.



FIGURE 7 Down-drain (Courtesy: G. Keller).

#### Useful Points

- Place erosion protection or seeding before rainfalls on all newly exposed surfaces.

- Have erosion materials ready before starting a job, in the event of rain (Orr 1998).



FIGURE 8 Concrete surface drainage (Courtesy: G. Keller).



FIGURE 9 Geotextile- and rock-lined ditch example of surface drainage (Courtesy: C. Gillies).

Rolling dip cross-drains, or broad-base dips, are designed for dispersing surface water on roads with slower traffic (Keller and Sherar 2003) (Figure 10). Relative to culvert pipes, rolling dips usually cost less, require less maintenance, and are less likely to plug and fail. Rolling dips are

ideal for low-volume roads with low to moderate traffic speeds [less than 30 mph (or 50 kph)] and low average daily traffic. Consider constructing rolling dips rather than ditches with culvert cross-drains on roads with grades less than 5:1 (H:V), or 20% to 10:1 (10%) (Copstead et al. 1989; Keller and Sherar 2003). It is important that rolling dips be deep enough to provide adequate drainage, perpendicular to the road or angled 25 degrees or less, outsloped 3% to 5%, and long enough [50 to 200 ft (15 to 60 m)] to allow vehicles and equipment to pass. In soft soils, it is important to armor the mound and dip with gravel or rock. Ideal spacing of rolling dip cross-drains is a function of the road grade and soil type (see Keller and Sherar 2003, p. 55, Table 7.1, for recommended spacing).

Use roadway cross-drain structures (e.g., rolling dips, culverts, open-top culverts, or flumes) to move water across the road from the inside ditch to the fill slope below the road (Keller and Sherar 2003). Space the cross-drain structures close enough to remove all surface water (see Keller and Sherar 2003, p. 55, Table 7.2, for recommended cross-drain spacing, or Copstead et al. 1989, pp. 9–11, Tables 3 and 4). Surface cross-drains not only provide effective cross drainage, but also reduce the risk associated with plugged drain inlets, which can divert water over the road (Copstead et al. 1989). In areas of cut slope instability, frost-heave slough, or erodible ditches, properly located and constructed surface cross-drains can result in less erosion and disturbance to the surrounding watershed. Use a 3% to 5% cross-slope if creating an insloped road in areas with steep natural slopes, erodible soils, or on sharp turns. Provide cross drainage with culverts, pipes or rolling dips and provide filter strip areas for infiltration and to trap sediment between drain outlets and waterways (Keller and Sherar 2003).

In Table 3, Howell (1999) provides bioengineering solutions to go with specific surface drainage treatments.

Culverts are commonly used as cross drains for ditch relief and to pass water under a road along a natural drainage (Orr 1998; Keller and Sherar 2003). Culverts need to be properly sized, installed, and protected from erosion and scour. Culverts are most commonly made of concrete or corrugated metal, plastic pipe, and occasionally wood or

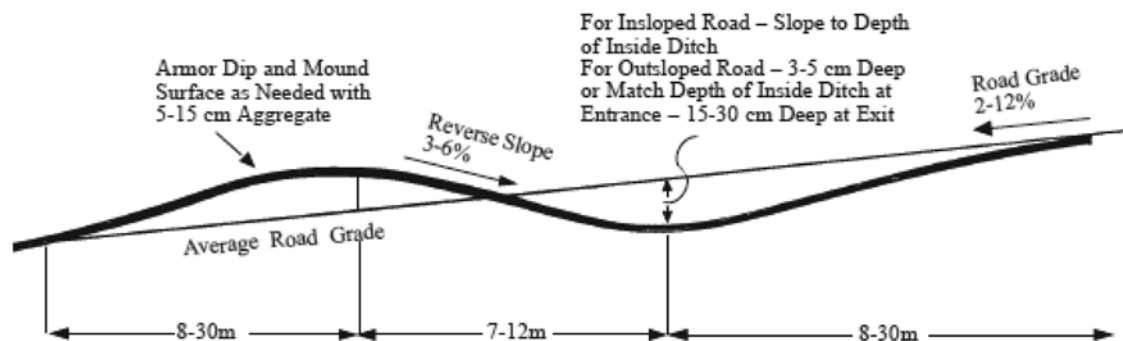

FIGURE 10 Rolling dip profile (Keller and Sherar 2003).

TABLE 3  
SURFACE DRAIN OPTIONS

Structure	Bioengineering	Main Sites	Advantages	Limitations
Unlined natural drainage system (rills, gullies)	Grasses in the rills, and grasses and other plants on the sides	Existing landslide scars and debris masses	An inexpensive form of surface drain. Allows for rapid drainage	There is a risk of renewed erosion from heavy rain on weak materials
Unlined earth ditches	Grasses and other plants on sides and between feeder arms	Slumping debris masses on slopes up to 1:1 (H:V) (45°), where the continued loss of material is not a problem	An inexpensive form of surface drainage	There is serious erosion hazard on steep main drains. Should be used only where further erosion is not a problem. Leakage into the ground may also occur
Unbound rock-lined ditches	Grasses between stones, and grasses and other plants on sides and between feeder arms	Can be used at almost any site, however unstable, where the ground is firm enough to hold rock and water flow is not excessive	A low-cost drain. Strong and flexible	A membrane of polyethylene may be required to stop leakage back into the ground. Somewhat expensive to clean and maintain
Bound cement masonry ditches	Grasses and other plants on sides and between feeder arms	For use on stable slopes with suitable material for good foundations	A strong structure for heavy water discharge	Relatively high cost. Very inflexible, high risk of cracking and failure due to subsidence and undermining
Open gabion ditches	Grasses and other plants on sides and between feeder arms	Can be used at almost any site, where the ground is firm enough to hold structure, and with heavy water discharge	A large and high cost type of drain. Very strong and flexible	A member of polyethylene may be required to stop infiltration of collected water

Source: Adapted from Howell (1999).

masonry (Keller and Sherar 2003). It is important that culverts have adequate flow capacity for the site, that the culvert size and shape match the needs of the site (e.g., fish passage), and that installation be cost-effective.

There is a need to dissipate the energy of surface runoff as it is concentrated in natural and man-made channels. Drain outlets can be armored to dissipate energy and prevent erosion using rock, brush, logging slash, non-erosive soils, rock, and/or vegetation (Keller and Sherar 2003). If heavier water discharge is anticipated, check dams, interceptor drains, benches, and contour terracing can be effective countermeasures.

**Useful Points**

- Use closely spaced leadoff ditches to prevent accumulation of excessive water in roadway ditches (Keller and Sherar 2003).
- Consider using a filter layer under or behind a selected treatment, such as riprap or a gabion structure. A filter can be made of small gravel or a geotextile placed between a structure and the underlying soil (Keller and Sherar 2003).

**Subsurface Drainage**

Subsurface drains are used to drain shallow groundwater, less than 15 ft (5 m) below the ground surface (GSPW 2003). This includes water within the road surface, base, and subgrade materials (Orr 1998). Subsurface drains, including underdrains and French drains, serve three functions: (1) intercept

water before it gets to the road, (2) lower the water table, and (3) remove excess free moisture (Orr 1998). Subsurface drains also collect seepage water from surface runoff and prevent it from raising the groundwater table (GSPW 2003).

Underdrains are usually very narrow and have some form of pipe in them. They are installed by a special machine, and they may or may not be wrapped in geotextile (Orr 1998). The geotextile filters out fine-grained soils that would otherwise accumulate and plug the pipe. One common way to backfill the underdrain trench is placing a layer of geotextile in the trench and then placing pipe, followed by clean stone around the pipe. The other option is to fill the trench with washed concrete sand.

Trench drains, or French drains, are usually installed with a backhoe or excavator, are fairly wide compared with underdrains, and may or may not have a pipe at the bottom (Orr 1998) (Figure 11). Using a pipe will greatly increase the life of the drain and help remove excess water. The trench can be lined with geotextile, then the pipe is placed, and then backfilled with clean stone ½ to ¼ in. in size.

When installing subsurface drains, always use filter protection such as a geotextile or properly sized sand or gravel. The purpose of the filter is to prevent migration of fine soil particles into underdrains, thereby allowing groundwater to drain from the soil without building up pressure. Even with a filter, subsurface drain pipes require periodic cleaning, which can be done using a sewer cleaner (Orr 1998). Deeper cleaning may be required if the pipe becomes completely plugged. Inlets and outlets should be cleared of debris and



flow maintained, animal guards should be installed over them, and mowing crews should be careful to not crush or damage them.

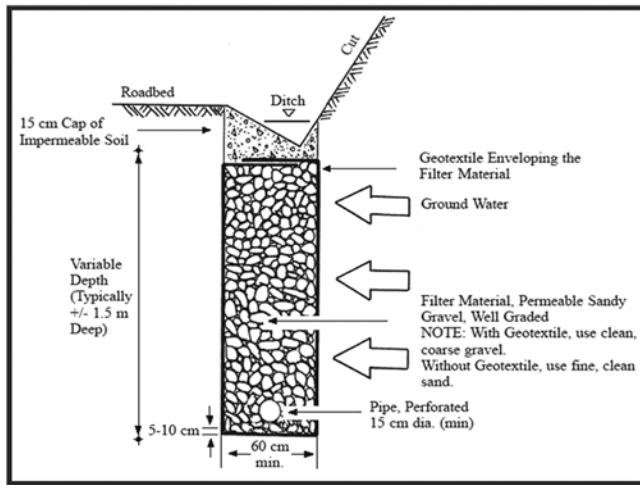

FIGURE 11 Subsurface drainage (Photo and drawing courtesy of G. Keller) .

Cross-drain pipes are used to pass water under a roadway from a ditch on the cut-slope side of the road to the fill-slope side of the road. The pipe is to be placed at the bottom of the fill (Figure 12). The inlet should be protected with a drop inlet structure or catch basin, and the outlet armored against erosion (Keller and Sherar 2003). Bedding and back-fill materials should be high quality, granular, non-cohesive,

less than 3 in. (7.5 cm) in diameter, well compacted, and skewed 0 to 30 degrees (preferably 30 degrees) from perpendicular to the road (Keller and Sherar 2003).

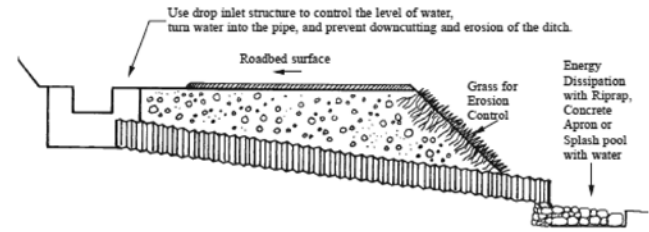

FIGURE 12 Typical drop inlet structure with culvert cross-drain (Keller and Sherar 2003).

Horizontal drains have been used historically for landslide correction, but can also be used generally for slope stabilization. Horizontal drains are installed to reduce excess pore-water pressure, thereby increasing slope stability (Long 1994) (Figure 13). Horizontal drains are drill-in drains that are inclined to match the subsurface geology. Horizontal drains have been shown to be a cost-effective alternative to major slope stabilization repairs, such as buttressing, when subsurface water is involved in the mechanics of failure.



FIGURE 13 Outlet of horizontal subsurface slope drainage (Courtesy: M. Long) .

Consider having a geotechnical expert perform a subsurface investigation of the soil and rock characteristics in the design phase (Long 1994). If economically feasible, the following techniques are suggested: area reconnaissance, ground survey, subsurface exploration for rock and soil type and water concentration, permeability testing, and ground and surface water mapping. Test drains should be installed to confirm final drain locations. Following installation, the site should be visited to ensure that proper drainage is occurring (see Long 1994, pp. 788–796, for design calculations).

Subsurface drains are usually civil engineering structures and do not normally use bioengineering measures (Howell 1999); however, bioengineering techniques can be

used to strengthen the slope around the drain or outlet. In Table 4, Howell (1999) provides some examples of how this can be done.

**Additional Resources for Water Management and Drainage**

Anderson, M.G., D.M. Lloyd, and M.J. Kemp, *Hydrological Design Manual for Slope Stability in the Tropics*, Transport Research Laboratory, Overseas Road Note 14, Berkshire, United Kingdom, 1997.

Cedergren, H., *Seepage, Drainage, and Flow Nets*, 3rd ed., John Wiley and Sons, New York, N.Y., 1989.

Copstead, R., K. Johansen, and J. Moll, Water/Road Interaction: Introduction to Surface Cross Drains, Water/Road Interaction Technology Series, Res. Rep. 9877 1806—SDTDC, Sep. 1998 [Online]. Available: <http://www.stream.fs.fed.us/water-road/w-r-pdf/crossdrains.pdf>.

FHWA, *Best Management Practices for Erosion and Sediment Control*, FHWA-SLP-94-005, FHWA, Sterling, Va., 1995.

Guide to Slope Protection Works (GSPW), His Majesty’s Government of Nepal. Ganabahal, Kathmandu, 2003.

Hearn, G.J. and R.W. Weeks, *Principles of Low Cost Road Engineering in Mountainous Regions, with Special Reference to Nepal, Himalaya*, C.J. Lawrence, Ed., Transport Research Laboratory, Overseas Road Note 16, Berkshire, United Kingdom, 1997.

Howell, J., *Roadside Bio-engineering: Site Handbook*, His Majesty’s Government of Nepal, Ganabahal, Kathmandu, 1999 [Online]. Available: <http://onlinepubs.trb.org/Onlinepubs/sp/Airport/RoadsideBioengineering.pdf>.

Keller, G. and J. Sherar, *Low-Volume Roads Engineering—Best Management Practices Field Guide*, Office of International Programs and U.S. Agency for International Development, USDA Forest Service, Washington, D.C., 2003 [Online]. Available: <http://www.fs.fed.us/global/topic/welcome.htm#12>.

Long, M.T., “Horizontal Drains: An Update on Methods and Procedures for Exploration, Design, and Construction of Drain Systems, Fifth International Conference on Low Volume Roads, May 19–23, 1991, Raleigh, N.C., *Transportation Research Record 1291*, Transportation Research Board, National Research Council, Washington, D.C., 1991, pp. 166–172.

Long, M.T., “Horizontal Drains, Application and Design,” Section 6D, In *The Slope Stability Reference Guide for National Forests in the United States*, Engineering Staff, Forest Service, USDA, Washington D.C., Dec. 1993 [Online]. Available: [http://www.fs.fed.us/rm/pubs\\_other/wo\\_em7170\\_13/wo\\_em7170\\_13\\_vol3.pdf](http://www.fs.fed.us/rm/pubs_other/wo_em7170_13/wo_em7170_13_vol3.pdf).

McCuen, R., P. Johnson, and R. Regan, *Highway Hydrology*, Hydraulic Design Series No. 2, 2nd ed., FHWA-NHI-02-001, National Highway Institute, Federal Highway Administration, Arlington, Va., 2002 [Online]. Available: <http://isddc.dot.gov/OLPFiles/FHWA/013248.pdf>.

Moll, J., R. Copstead, and D.K. Johansen, *Traveled Way Surface Shape*, San Dimas Technology and Development Center, Forest Service, U.S. Department of Agriculture, Washington, D.C., Oct. 1997 [Online]. Available: <http://www.stream.fs.fed.us/water-road/w-r-pdf/surfaceshape.pdf>.

Normann, J., R. Houghtalen, and W. Johnston, *Hydraulic Design of Highway Culverts*, Hydraulic Design Series (HDS) No. 5, FHWA-NHI-01-020, Federal Highway Administration and National Highway Institute, Washington, D.C., 2001 (rev.

TABLE 4  
SUBSURFACE DRAIN OPTIONS

Structure	Bioengineering	Main Sites	Advantages	Limitations
French drain* or underdrain with pipe	Grasses and other plants along the sides and between feeder arms	Almost any site where the ground is firm enough to hold the structure and the flow of water is not too heavy for this construction technique	A relatively low-cost and common subsurface type of drain. Very flexible. A good option for unstable slopes	A membrane of permeable geotextile should be used. If the water flow is heavy, piping may occur under ground. The outlet should be monitored periodically
Site-specific design of drain to pick up seepage water. An open ditch or a drain with a flexible gabion lining is preferred	Planted grasses and other species along the sides	Any slope with obvious seepage lines	Specific drains can be designed for any site, for optimum water collection	Great care is needed to ensure that all seepage water is trapped by the drain. Movement in the slope may affect this
Horizontal drains	Plant grasses at the pipe outlet	Moderate to deep-seated slides	Can lower the groundwater level in the slope	May or may not intercept and drain all of the groundwater

Source: Adapted from Howell (1999).

\*Perforated pipe of durable, high-grade black polyethylene, 6 in. (150 mm) diameter with approximately 40 holes of 0.2 in. (5 mm) per 3.28 ft (or 1 m) in drainage composed of medium aggregate. Drain can be made more resistant to disruption by building it in a wire gabion casing.

2005) [Online]. Available: [http://www.fhwa.dot.gov/engineering/hydraulics/library\\_arc.cfm?pub\\_number=7&id=13](http://www.fhwa.dot.gov/engineering/hydraulics/library_arc.cfm?pub_number=7&id=13).

Orr, D., *Roadway and Roadside Drainage*, CLRP Publication No. 98-5, Cornell Local Roads Program and New York LTAP Center, Ithaca, N.Y., 1998 (updated 2003) [Online].

Available: [http://www.clrp.cornell.edu/workshops/pdf/drainage\\_08\\_reprint-web.pdf](http://www.clrp.cornell.edu/workshops/pdf/drainage_08_reprint-web.pdf).

Shah, B.H., *Field Manual on Slope Stabilization*, United Nations Development Program, Pakistan, Sep. 2008 [Online]. Available: <http://www.preventionweb.net/english/professional/publications/v.php?id=13232>.

## CHAPTER THREE

**EROSION CONTROL TECHNIQUES**

This section summarizes literature and interview results on erosion control techniques. Erosion is the process of separating and transporting sediment by water, wind, gravity, or other geologic processes (Atkins et al. 2001). It is a natural process that can be accelerated by vegetation removal, top-soil disturbance or compaction, or creation of steep slopes. (Hyman and Vary 1999). It has been reported that the logarithm of sediment yield (in kg/km<sup>2</sup>) features a positive linear relationship with the logarithm of runoff depth (in mm), based on a field study of embankment slopes along the Qinghai–Tibet highway in China (Xu et al. 2005). The same study also confirmed that there is a positive linear relationship between the runoff depth and the product of rain intensity (in millimeters/hour) and rain precipitation (in millimeters).

**TYPES OF EROSION**

Three types of erosion are common: surface, rill, and gully (Orr 1998) (Figure 14). Surface, or sheet, erosion occurs when rainfall dislodges soil on the surface of material, and the water and soil flow down a slope in sheets. Rill erosion occurs when the velocity of the water flow is great enough to dislodge soil in addition to that dislodged by rainfall. Typical rill erosion has small, narrow channels that form in banks and on slopes not protected from erosion. Gully erosion occurs when rill erosion combines and concentrates the flow of runoff into gullies. Although soils erode differently, for most road materials it can be assumed that exposed soils will erode and cause sedimentation. Generally speaking, the flatter the slope, the fewer erosion problems occur.

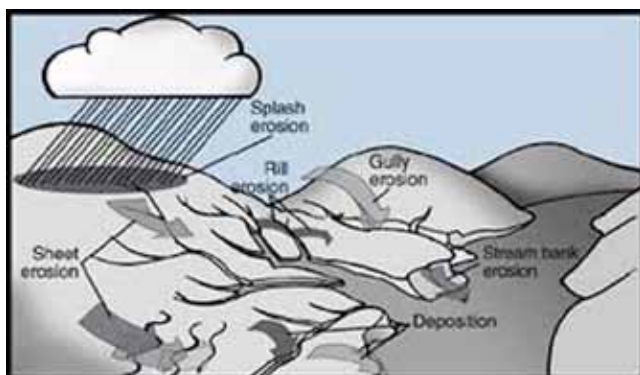

FIGURE 14 Types of soil erosion by water (from [www.extension.missouri.edu](http://www.extension.missouri.edu)).

Erosion control is the proactive prevention of the loss of surface soil. Erosion control has been shown to have a higher level of effectiveness than sediment control—trying to catch the soil once it has eroded away (Atkins et al. 2001). The main goals of erosion control are to minimize potential erosion from disturbed sites and to then limit the transport of sediment from these sites.

For effective erosion control, consider a systematic approach that includes design, construction, and maintenance issues; various temporary and permanent erosion control methods; and new technologies (Johnson et al. 2003). Also take into account government regulations and permitting requirements. It is important to consider erosion control in the design stage of a project, and a detailed erosion control plan should be developed before construction begins to identify the erosion problem areas and to devise effective and economical measures to prevent or, at the least, control erosion (SDDOT 2004).

General practices that can aid in erosion control include confining operations to periods of dry weather, minimizing traffic through areas, selecting equipment that will create less soil disturbance, and minimizing the area of disturbance at any one time (Atkins et al. 2001).

It is important that temporary erosion control measures be used during construction, especially when the construction occurs in steep, rolling topography; where most of the drainage enters directly into adjacent water bodies or wetlands; or where the subsoils are erosive. In selecting such measures, consider the following factors: purpose, grade or slope, amount of on-site water flow, length of time the treatment will be effective, ease of construction, maintenance requirements, and cost. Common devices for temporary erosion control include earth diversions and swales, erosion control blankets and stabilization mats, mulching and turf establishment, ditch checks, sandbag barriers, silt fences, soil berms, temporary slope stabilization and pipe down-drains, and triangle silt dikes. Note that temporary sediment control measures (e.g., biorolls, drainage swales, inlet protection, perimeter control, sediment basins, sediment traps, silt curtains, silt fences, standpipes, treatment basins) are also needed during construction to prevent off-site damage from sediment flowing into lakes, rivers, streams, and adjacent lands.

After projects are completed and vegetation is established, permanent measures are to be implemented for erosion control purposes. Common devices for permanent erosion control include ditches and liners, riprap, runoff spreaders, soil bioengineering, and turf establishment. Detention ponds can be used to trap eroded material and control water flow. It has been reported that engineering measures (e.g., concrete pre-fabricated panes, Lattice, or runoff interception and drainage) can quickly reduce runoff and soil loss from road sideslopes, whereas revegetation has great potential once the vegetation cover is well established. The findings were based on a field evaluation of various erosion control measures along the Qinghai–Tibet highway in China, an area that features “high altitude, low summer rainfall and permanently poor vegetation cover” (Xu et al. 2006). A combined measure (Lattice plus Common Seedling) was found to be most effective in both short-term and long-term erosion control (Xu et al. 2005).

Many erosion control methods are frequently used alone or in conjunction with soil stabilization. This section presents some examples of cost-effective and sustainable erosion control treatments most frequently used in conjunction with soil stabilization techniques.

#### Useful Points

- Consider erosion control/stabilization work as quickly and early in the project as you can (J. Haag, personal communication, April 19, 2011).
- When working on slopes steeper than 3:1 (H:V), consider using soil stabilization blankets that can be pinned down or used in conjunction with mulch. It appears to save time and money in the long run (B. Johnson, personal communication, April 18, 2011).
- Consider putting in place interim erosion control measures during seasonal shutdowns (Keller and Sherar 2003).

#### Additional Resources for Erosion Control

American Association of State Highway and Transportation Officials (AASHTO), Washington, D.C. [Online]. Available: <http://transportation.org/>.

Atkins, R.J., M.R. Leslie, D.F. Polster, M.P. Wise, and R.H. Wong, *Best Management Practices Handbook: Hill-slope Restoration in British Columbia*, Resource Tenures and Engineering Branch, BC Watershed Restoration Program, BC Ministry of Forests, Victoria, Canada, 2001. [Online]. Available: <http://www.ieca.org/resources/federal-statewebsites.asp>.

CDM, Inc., *Erosion and Sediment Control Best Management Practices: Report*, Revised May 2004 [Online]. Available: <http://www.mdt.state.mt.us/research/projects/env/erosion.shtml>.

California Department of Transportation (Caltrans), *Stormwater and Water Pollution Control*, Caltrans Division of Construction, Sacramento, 2011 [Online]. Available: <http://www.dot.ca.gov/hq/construc/stormwater/stormwater1.htm>.

Environmental Protection Agency (EPA), *National Pollutant Discharge Elimination System: National Menu of Stormwater Best Management Practices*, EPA, Washington, D.C., 2008 [Online]. Available: <http://cfpubl.epa.gov/npdes/stormwater/menuofbmps/index.cfm>.

FHWA, *Best Management Practices for Erosion and Sediment Control*, FHWA-SLP-94-005, FHWA, Sterling, Va., 1995.

Gillies, F., *Erosion and Sediment Control Practices for Forest Roads and Stream Crossings – A Practical Operations Guide*, Advantage Vol. 9, No. 9, FP Innovations, FERIC Division, Forest Engineering Research Institute of Canada, Western Region, BC, Canada, 2007.

International Erosion Control Association (IECA), Denver, Colo. [Online]. Available: [www.ieca.org](http://www.ieca.org).

Johnson, A., A. Moffatt, and E. Slattery, *Erosion Control Handbook for Local Roads*, Minnesota Local Road Research Board (LRRB) Manual Number 2003-08, Minnesota Department of Transportation, St. Paul, 2003.

Local Soil and Water Conservation Districts, Natural Resources Conservation Service (NRCS), Washington, D.C. [Online]. Available: [www.nrcs.usda.gov](http://www.nrcs.usda.gov).

Orr, D., *Roadway and Roadside Drainage*, CLRP Publication No. 98-5, Cornell Local Roads Program and New York LTAP Center, Ithaca, N.Y., 104 pp., 1998 (Updated 2003) [Online]. Available: [http://www.clrp.cornell.edu/workshops/pdf/drainage\\_08\\_reprint-web.pdf](http://www.clrp.cornell.edu/workshops/pdf/drainage_08_reprint-web.pdf).

Rivas, T., *Erosion Control Treatment Selection Guide*, Gen. Tech Rep. 0677 1203—SDDOT, San Dimas Technology and Development Center, USDA Forest Service, San Dimas, Calif., 2006 [Online]. Available: [http://www.fs.fed.us/eng/pubs/pdf/hi\\_res/06771203hi.pdf](http://www.fs.fed.us/eng/pubs/pdf/hi_res/06771203hi.pdf).

South Dakota Department of Transportation (SDDOT), “Roadside Development” *Road Design Manual*, SDDOT, Pierre, 2004 [Online]. Available: <http://www.sddot.com/pe/roaddesign/docs/rdmanual/rdmch14.pdf>.

#### GRASS SEEDING

Seeding with grasses is one of the most common methods used to protect soils, and in many states and countries it



is a standard specification. Grass is very effective at covering soil and protecting soil from wind and water erosion (Shah 2008). When seeding with grasses, it is ideal to use a mixture of creeping and clumping types. Creeping grasses form a continuous root system, or mat. Clumping grasses leave gaps between the plants that can be vulnerable to erosion, but they can grow large with deep roots (Hearn and Weeks 1997). Seed mixtures normally include grasses that germinate rapidly—such as rye or annual grass—to provide immediate short-term protection, and slower-growing perennial grasses that provide long-term protection. The optimum seed mix depends on the soil, site, and climatic conditions (Schor and Gray 2007). It is also very important to consider use of native seed varieties at each site. With the help of a botanist, horticulturalist, ecologist, or a local conservation agency, the appropriate seed varieties can be chosen for each site.

To ensure the highest success rate, always scarify, or loosen, the surface soil (Howell 1999). Once the seed has been sown, apply mulch, netting, or sheeting to protect the seeds and to keep the moisture in. If grass seeds are sown on steep angled slopes (greater than 30 degrees), consider netting the mulch (Howell 1999). Maintenance may include protection from grazing animals, weeding, and possible thinning of shrubs if included in the seed mix. The timing of planting is critical. For example, seeds should be sown in the late fall, winter, or spring (USDA 1992). In temperate zones, watering may be necessary initially to ensure that the seeds are established if they are sown at other times. At each site, seeds should be matched to the site conditions.

Grasses can be established by manual or hand seeding, hydro-seeding, or with turf or sod (Hearn and Weeks 1997). Use of turf and/or sod is not discussed in this section because of the high cost compared with hand or hydro-seeding. It is sometimes possible to get local sod farms to grow native grass sod (Dollhopf et al. 2008). If this is the best treatment option for the site, contact local sod farms directly to check on the availability of native grass sod or the option to grow a test plot.

“A low-cost technique that is highly effective and underutilized is native-grass-sod-lined ditches. Several companies are developing native grass sod in rolls up to 4 ft wide. It can easily be installed in ditches or in areas of concentrated flow around culverts, bridge abutments, etc. Sod is ‘expensive’ compared to seed, but it is inexpensive compared to fabric-lined channels and much more effective” (S. Jennings, personal communication, April 12, 2011).

#### Hand Seeding

Hand seeding is accomplished by throwing seed by hand directly onto a site. The use of grass seed allows for easy veg-

etative coverage of large areas (Howell 1999). Grass seeding is often used in conjunction with mulching and netting to aid in grass establishment. Initially, the grass armors against erosion, and later, as roots develop, it also acts to reinforce shallow soil (Howell 1999). Grass seed should be sown on soils that drain well.

#### Hydro-seeding

Hydro-seeding utilizes high-pressure pumps to apply a slurry of water, wood fiber mulch, seed, and fertilizer onto a slope (NRCS 2011) (Figure 15). Hydro-mulching is the application of a slurry of water, wood fiber mulch, and often a tackifier. The terms hydro-seeding and hydro-mulching are often used interchangeably. The benefits are the same as hand seeding; initially, the grass armors the soil against erosion, and then once the roots are established, it reinforces shallow soil. The benefit of hydro-seeding is that it can be used on just about any site (Howell 1999) and has a high success rate (Hearn and Weeks 1997). Often the limiting factor is the length of the hose used for spraying the hydro-seed, or how far the pumps can spray the materials [approximately 300 ft (100 m) or less] (Howell 1999). Grass seed should be sown on soils that drain well.



FIGURE 15 Hydro seeding of a slope (Courtesy: M. Long).

#### Grass Slips

Grass slips, or small clumps of grass pulled from a larger mass, can be planted horizontally, vertically, diagonally, in a random pattern, or for full coverage (Hearn and Weeks 1997). The varying planting patterns can help create contours to the slope and channel or slow the surface flow of water, depending on site needs (Hearn and Weeks 1997).

#### Deeply Rooted Grasses

Another category of grasses that have been used to stabilize structures, including earth embankments and road cuts, water and drainage ways, and at building sites, are

deeply rooted grasses such as vetiver (Grimshaw and Faiz 1995). Vetiver grass (*Vetiveria zizanioides*) is a densely tufted perennial grass that grows in large clumps with very branched and spongy root mass (World Bank 1990). Vetiver grass has been proven to aid in soil and moisture conservation and has a wide geographic and ecological area of adoption. Vetiver has been shown to decrease water runoff by up to 57% and reduce soil loss by more than 80% compared with stone barriers, other vegetation, and bare ground (Rao et al. 1992). Over time, as the hedge grows larger and the vegetation becomes denser, these numbers further improve (Rao et al. 1993).

Vetiver grass has not been observed to be an invasive species; generally it produces no seeds, but if seeds are produced they tend to be sterile (Grimshaw and Faiz 1995). Vetiver hedges can take 2 months to 4 years to establish. Vetiver can grow in a wide range of soil types and pH levels, but it will not survive prolonged exposure to subzero temperatures typically seen in the continental Northern Hemisphere. Vetiver grass can be planted horizontally across slopes to create a bench, slow the migration of water, and trap sediment; in gullies to slow water flow; or around engineered structures to stabilize soil (Grimshaw and Faiz 1995). It has been used for slope stabilization in Bangladesh, Brazil, China, and Thailand for decades, and is an inexpensive slope stabilization tool that improves performance with time.

#### Useful Points

- When there isn't a mixture of shallow and deep-rooted vegetation you can end up with the sod looking like a bunch of carpet at the bottom of the slope. Grass and legume seed roots only stabilize the surface; you need woody species (or plants with deeper) roots to stabilize at depth (D. Polster, personal communication, April 29, 2011).
- You can never put too much grass seed down (D. Orr, personal communication, May 3, 2011).

#### Additional Resources for Grass Seeding

Andreu, V., et al., "Ecotechnological Solutions for Unstable Slopes: Ground Bio- and Eco-Engineering Techniques and Strategies," In *Slope Stability and Erosion Control: Ecotechnological Solutions*, J.E. Norris, et al., Eds., Springer, Dordrecht, the Netherlands, 2008.

Caltrans, *Statewide Stormwater Quality Practice Guidelines*, CTSW-RT-02-009, Caltrans, Sacramento, 2003.

FHWA, *Best Management Practices for Erosion and Sediment Control*, FHWA-SLP-94-005, FHWA, Sterling, Va., 1995.

Grimshaw, R.G. and A. Faiz, "Vetiver Grass: Application for Stabilization of Structures," In *Proceedings of the Sixth*

*International Conference on Low-Volume Roads*, Minneapolis, Minn., June 25–29, 1995.

Goldman, S., K. Jackson, and T.A. Bursztynsky, *Erosion and Sediment Control Handbook*, McGraw Hill, New York, N.Y., 1986.

Hearn, G.J. and R.W. Weeks, *Principles of Low Cost Road Engineering in Mountainous Regions, with special reference to Nepal*, Himalaya, C.J. Lawrence, Ed., Transportation Research Library Overseas Road Note 16, Berkshire, United Kingdom, 1997.

Howell, J., *Roadside Bio-engineering: Site Handbook*, His Majesty's Government of Nepal, Ganabahal, Kathmandu, 1999 [Online]. Available: <http://onlinepubs.trb.org/Onlinepubs/sp/Airport/RoadsideBioengineering.pdf>.

Natural Resources Conservation Service (NRCS), Washington, D.C., 2011 [Online]. Available: <http://www.wy.nrcs.usda.gov/technical/ewpfactsheets/hydroseed.html>.

Shah, B.H., *Field Manual on Slope Stabilization*, United Nations Development Program, Pakistan, Sep. 2008 [Online]. Available: <http://www.preventionweb.net/english/professional/publications/v.php?id=13232>.

World Bank, *Vetiver Grass—The Hedge Against Erosion*, 3rd ed., Washington, D.C., 1990.

#### MULCH AND COMPOST

Mulch is used as a temporary measure to help with the establishment and growth of vegetation, but mulch alone will not protect a slope from eroding or establish vegetative cover (Howell, 1999). Mulch can be organic (e.g., compost, grass clippings, straw, bark, leaf litter) or inorganic (e.g., stone) (Sotir and Gray 2011). Mulch can be applied in various ways, including spreading it over the entire slope, over sown seeds, or around individual plants (Howell 1999). Mulch helps to keep soil cool and moist and enhances growth and early establishment of shrub and tree seedlings (Howell 1999). A good option for armoring sown grass seed is to mulch the entire site with chopped plant material or brushwood cleared from the site (Howell 1999).

Mulching is suitable for any site with slopes up to 45 degrees and with well-draining materials (Howell 1999). For slopes greater than 45 degrees, erosion-control netting or blankets may be necessary to keep the mulch in place. Because mulching is a temporary measure, no maintenance is required (Howell 1999).

Compost is decomposed or aged organic matter. It can be used as mulch or added to the soil as an amendment, and

can be used to create a berm or dike to control erosion (EPA 2008). Compost berms can be placed perpendicular to sheet flow and are generally trapezoidal in cross section. Compost filter berms are generally placed along the perimeter of a site or at intervals on a slope, reducing the speed of sheet flow and retaining sediment and pollutants. They can be used in place of silt fences, and do not need to be removed from the site once work is completed. Compost can also be used to fill wattles or fiber rolls, check dams, or be vegetated. The quality of the compost is important to consider [see the National Menu of Stormwater Best Management Practices (EPA 2008) for additional information].

Research has shown that compost can improve vegetation establishment and density. Test sections in arid southwest Montana monitored by Ament et al. (2011) demonstrated that 0.5–1 in. of compost was sufficient to establish 16% to 25% vegetation density at a cost of \$16,000–\$33,000 (using a blower truck to place the material similar to hydro-mulch) for this site. The same study demonstrated that coconut fiber and thin plastic netting were more effective at retaining compost than soil tackifiers. Field studies in Washington (in both the wetter western and drier eastern parts of the state) also showed that compost improved vegetation establishment and density while reducing weeds and erosion (Lewis et al. 2001). The researchers found better results when the compost was incorporated (raked) into the soil, including enhanced grass growth, increased soil workability, and a more diverse grass community.

“Compost blanket application of 1–3 cm is very environmentally friendly in terms of reusing waste, aids in erosion control and vegetation establishment. The costs associated with these treatments range from low to high depending on the site-specific characteristics such as procurement cost, transportation cost, method of application, etc. Compost can be considered high cost compared to leaving bare soil in an eroded condition, but I take the position that bare and erosive transportation corridors are unacceptable” (S. Jennings, personal communication, April 12, 2011).

#### Additional Resources for Mulch and Compost

Caltrans, *Statewide Stormwater Quality Practice Guidelines*, CTSW-RT-02-009, Sacramento, 2003.

EPA, *National Pollutant Discharge Elimination System: National Menu of Stormwater Best Management Practices*, EPA, Washington, D.C., 2008 [Online]. Available: <http://cfpub1.epa.gov/npdes/stormwater/menuofbmps/index.cfm>.

FHWA, *Best Management Practices for Erosion and Sediment Control*, FHWA-SLP-94-005, FHWA, Sterling, Va., 1995.

Howell, J., *Roadside Bio-engineering: Site Handbook*, His Majesty's Government of Nepal, Ganabahal, Kathmandu, 1999 [Online]. Available: <http://onlinepubs.trb.org/Onlinepubs/sp/Airport/RoadsideBioengineering.pdf>.

#### EROSION-CONTROL GEOTEXTILES

Erosion-control geotextiles, including blankets and mats, are generic terms given to woven or bonded fabrics that are placed directly on soil for temporary erosion control (TIRRS 2001; EPA 2008). Erosion-control blankets and mats protect the surface from raindrop impact (TIRRS 2001), wind and stormwater erosion, and they allow vegetation to grow (EPA 2008). Geotextiles can be biodegradable, such as jute, wood fiber, paper or cotton, or synthetic and made of plastic.

Geotextiles can be used to stabilize the flow of water in channels or swales, to protect seedlings or vegetation, to protect exposed soil, or to separate soil from other slope stabilization treatments such as riprap (EPA 2008). Lay the geotextile so it has continuous contact with the soil surface, or erosion can occur. Geotextiles should also be pinned in place. This can be done with stakes made of wood, metal, corn plastic, or live cuttings (NRCS 2007).

Plastic geotextiles can trap and harm small animals (Figure 16), even if the material is photodegradable. This issue is to be considered in advance; if possible, more easily biodegradable fiber materials should be used to minimize potential disturbance to wildlife (TIRRS 2001).

#### Additional Resources for Erosion-Control Geotextiles

Caltrans, *Statewide Stormwater Quality Practice Guidelines*, CTSW-RT-02-009, Sacramento, 2003.

EPA, *National Pollutant Discharge Elimination System: National Menu of Stormwater Best Management Practices*, EPA, Washington, D.C., 2008 [Online]. Available: <http://cfpub1.epa.gov/npdes/stormwater/menuofbmps/index.cfm>.

FHWA, *Best Management Practices for Erosion and Sediment Control*, FHWA-SLP-94-005, FHWA, Sterling, Va., 1995.

NRCS, “Temporary Erosion Control Around the Home Following a Fire: Jute Netting,” *NRCS Fact Sheet*, California FS-54, 2007 [Online]. Available: <ftp://ftp-fc.sc.egov.usda.gov/CA/programs/EWP/2007/FS54.pdf>.

Orr, D., *Roadway and Roadside Drainage*, CLRP Publication No. 98-5, Cornell Local Roads Program and New York LTAP Center, Ithaca, N.Y., 1998 (updated 2003), 104 pp. [Online]. Available: [http://www.clrp.cornell.edu/workshops/pdf/drainage\\_08\\_reprint-web.pdf](http://www.clrp.cornell.edu/workshops/pdf/drainage_08_reprint-web.pdf).



Tahoe Interagency Roadway Runoff Subcommittee (TIRRS), *Planning Guidance for Implementing Permanent Storm Water Best Management Practices in the Lake Tahoe Basin*, Chapter 6, “Slope Stabilization Techniques,” 2001.



FIGURE 16 Eastern racer (*Coluber constrictor*) caught in highway right-of-way, Montana (Courtesy: T. Allen).

### Jute and Other Biodegradable Netting

Jute is a rough fiber that is woven to create an organic and biodegradable net. Jute netting protects the soil surface, armoring against erosion and catching small debris, allows seeds to hold and germinate, and improves the microclimate on the slope surface by holding moisture and increasing infiltration. As it decays, it acts as a mulch for the growing vegetation (Howell 1999) (Figure 17). Any use of jute netting is a temporary measure designed to enhance vegetation establishment.

It is sometimes possible to have netting made locally from jute grown in the region (Hearn and Weeks 1997). In Brazil, low-cost biotextiles made from native palms for use as biodegradable erosion control mats proved successful at reducing soil loss while maintaining soil moisture and anchoring seeds.

Other common materials used are coir fiber, excelsior mats, and straw. Coir is made from the husks of coconuts. Coir can be woven into mesh or net, or made into blankets (Coir Institute 2011). Excelsior mats are composed of dried, shredded wood and covered with a fine paper net (Goldman et al. 1986).



FIGURE 17 Biodegradable netting with planted vegetation, Floras Creek, Oregon (Courtesy: M. Long).

Standard netting is used on steep, hard slopes where conditions are too harsh for vegetation to establish itself without assistance (Howell 1999). Normal use is on slope angles of 45 to 60 degrees (Howell 1999). Netting is best used on well-drained materials that are too hard to allow vegetation to become established unaided, or on slopes exposed to hot sun and where extreme drought would otherwise be a problem (Howell 1999). It should not be used on soft or poorly drained soils, and never used on soils with a high rate of shallow slumping (Howell, 1999). Jute netting should be anchored in place with pins or staples (NRCS 2007). Jute netting can be easily integrated with soil bioengineering by planting grass slips through the holes in the netting in a random pattern fairly close together. If deeper reinforcement is required, the surface can be seeded with shrubs or small trees before the netting is laid down (Howell 1999).

Jute netting does not protect a surface if used alone. No maintenance is necessary for jute netting; it will rot away over time (Howell 1999). It has been found to last for two or three seasons of rains before it degrades (Howell 1999), but it may last longer in less extreme climates.

### Additional Resources for Jute and Other Biodegradable Netting

Goldman, S., K. Jackson, and T. A. Bursztynsky, *Erosion and Sediment Control Handbook*, McGraw Hill, New York, N.Y., 1986.

Howell, J., *Roadside Bio-engineering: Site Handbook*, His Majesty's Government of Nepal, Ganabahal, Kath-

mandu, 1999 [Online]. Available: <http://onlinepubs.trb.org/Onlinepubs/sp/Airport/RoadsideBioengineering.pdf>.

Orr, D., *Roadway and Roadside Drainage*, CLRP Publication No. 98-5, Cornell Local Roads Program and New York LTAP Center, Ithaca, N.Y., 1998 (updated 2003), 104 pp. [Online]. Available: [http://www.clrp.cornell.edu/workshops/pdf/drainage\\_08\\_reprint-web.pdf](http://www.clrp.cornell.edu/workshops/pdf/drainage_08_reprint-web.pdf).

### Other Netting

There are many other erosion-control netting options. Many are made of nonbiodegradable materials and therefore persist in the environment. Use of these products is not as sustainable a practice as using biodegradable products, and additional time for cleaning up the product once it has served its purpose may be necessary. Note that nonbiodegradable netting is also used to reinforce sod and encase wattles, and for many other purposes.

### Rock Blankets or Riprap

Rock blankets are created by placing a layer of loose rock or aggregate over an erodible soil surface (TIRRS 2001) (Figure 18). Rock blankets can be used with a variety of other techniques, such as seeding or planting of cuttings, or between other erosion-control measures to break up a slope. Ideally, rock would be available locally or on site and would match the surrounding landscape. Rock blankets are best used in areas where revegetation is difficult, and are often used on steep slopes above retaining walls. This technique should not be used on slopes greater than 2:1 (EPA 2008).



FIGURE 18 Rock blanket on a cut slope for erosion control, Lake Tahoe (Courtesy: G. Keller).

To install a rock blanket, excavate out the loose material or clear the slope if necessary, if seeding, then broadcast the seed (TIRRS 2001). Then place rock or aggregate. Geotextiles can be placed over the soil before the rock is placed to reduce soil erosion. Rock joint planting can also be used to further stabilize the slope.

It is important that rock blankets not be used where they would pose a public safety hazard. They require little to no maintenance. Follow-up maintenance may include periodic inspection to see if rocks have dislodged (TIRRS 2001).

### Additional Resources for Rock Blankets or Riprap

EPA, *National Pollutant Discharge Elimination System: National Menu of Stormwater Best Management Practices*, EPA, Washington, D.C., 2008 [Online]. Available: <http://cfpub1.epa.gov/npdes/stormwater/menuofbmps/index.cfm>.

Goldman, S., K. Jackson, and T. A. Bursztynsky, *Erosion and Sediment Control Handbook*, McGraw Hill, New York, N.Y., 1986.

Orr, D., *Roadway and Roadside Drainage*, CLRP Publication No. 98-5, Cornell Local Roads Program and New York LTAP Center, Ithaca, N.Y., 1998 (updated 2003), 104 pp. [Online]. Available: [http://www.clrp.cornell.edu/workshops/pdf/drainage\\_08\\_reprint-web.pdf](http://www.clrp.cornell.edu/workshops/pdf/drainage_08_reprint-web.pdf).

Tahoe Interagency Roadway Runoff Subcommittee (TIRRS), *Planning Guidance for Implementing Permanent Storm Water Best Management Practices in the Lake Tahoe Basin*, Chapter 6, "Slope Stabilization Techniques," 2001.

### CHECK DAMS

Check dams are a physical construction that prevents down-cutting of water in gullies (Howell 1999). Check dams reduce the gradient of a gully by providing periodic steps that trap the water, and safely discharge the water at a lower velocity to the next step. By trapping sediment on their upstream side, check dams create a stepped channel bed profile, thus reducing velocities and channel down-cutting, and ultimately halting the progression of erosion (Hearn and Weeks 1997). Check dams can be used in any type of gully or rill that is in danger of enlarging or on any slope where there is a danger of water scour (Howell 1999). There are many ways to construct check dams, including loose stone, gabion baskets, concrete, stone masonry, live brushwood, palisades, and vegetated poles (Shah 2008) (Figures 19–21). The selection of materials to be used may be based on what is available on site, and whether vegetation is desired as a permanent measure.

It is important to consider the location, spacing, and size of the check dams. The check dam location should be selected to achieve the maximum effect with the minimum amount of construction (Howell 1999). Check dams are normally placed where they can protect weak parts of a gully from scour, utilizing natural topography such as natural nick points, debris piles or foundations, or bedrock anchor points. In situations where the gully is too steep or irregular,



the check dams should be placed where a stable cross section is available with strong points for keying-in the structure (Hearn and Weeks 1997).



FIGURE 19 Wooden check dams with rock reinforcement (Courtesy: D. Orr).



FIGURE 20 Stone check dams (Courtesy: D. Orr).



FIGURE 21 Rock pile check dams (Courtesy: G. Keller).

The following are key design points for gully stabilization in check dams are (G. Keller, personal communication, Nov. 22, 2011):

1. Remove the source of water to the gully if at all possible.
2. Have a weir over the top of the check dam to keep the flow in the middle of the channel (as shown in Figure 19).
3. Key the check dam into the sides of the gully and compact the soil well around the structure.
4. Protect the outfall from the structure to prevent undermining of the structure. Use riprap, gabions, or other energy dissipation, or drop into the pool of the next downstream structure.

#### Live Check Dams or Vegetated Pole Check Dams

To create live or vegetated pole check dams, large woody cuttings are planted across a gully, usually following the contour, forming a strong barrier and trapping material moving down-slope (Howell 1999). Over time, a small step will form in the gully floor.

This technique can be used in gullies with slopes up to 2:1 (27 degrees) (Howell 1999). It should not be used in areas with high rates of slumping. Spacing of live check dams varies with slope steepness and profile, normally 9 to 16 ft (3 to 5 m) apart is sufficient. Within the live check dam, spacing of the cuttings can be very close (less than an inch apart), but on gentle slopes spacing can be wider. Planting a double, offset line of cuttings will make a much stronger live check dam. Generally, little to no maintenance is needed, with the exception of replacing failed sections or thinning established vegetation (Howell 1999).

#### Useful Points

- The size of the check dams may need to be increased down-slope to accommodate additional water drainage from the watershed (S. Jennings, personal communication, April, 12, 2011).

#### Additional Resources for Check Dams

Caltrans, *Statewide Stormwater Quality Practice Guidelines*, CTSW-RT-02-009, Caltrans, Sacramento, 2003.

FHWA, *Best Management Practices for Erosion and Sediment Control*, FHWA-SLP-94-005, FHWA, Sterling, Va., 1995.

Goldman, S., K. Jackson, and T. A. Bursztynsky, *Erosion and Sediment Control Handbook*, McGraw Hill, New York, N.Y., 1986.

Grimshaw, R.G. and A. Faiz, “Vetiver Grass: Application for Stabilization of Structures,” In *Proceedings of the Sixth International Conference on Low-Volume Roads*, Minneapolis, Minn., June 25–29, 1995.

Hearn, G.J. and R.W. Weeks, *Principles of Low Cost Road Engineering in Mountainous Regions*, with special reference to Nepal, Himalaya, C.J. Lawrence, Ed., Transportation Research Library Overseas Road Note 16, Berkshire, United Kingdom, 1997.

Howell, J., *Roadside Bio-engineering: Site Handbook*, His Majesty’s Government of Nepal, Ganabahal, Kathmandu, 1999 [Online]. Available: <http://onlinepubs.trb.org/Onlinepubs/sp/Airport/RoadsideBioengineering.pdf>.

Shah, B.H., *Field Manual of Slope Stabilization*, United Nations Development Program, Pakistan, Sep. 2008 [Online]. Available: <http://www.preventionweb.net/english/professional/publications/v.php?id=13232>.

## WATTLES OR FIBER ROLLS

Wattles, or fiber rolls, are tube-shaped erosion control devices that are filled with straw, rice husks, flax, coconut fiber, or composting material that is wrapped in netting (Caltrans 2003; SWS 2008). The netting can be made of biodegradable materials such as jute, coir, or burlap, or nonbiodegradable polypropylene (SWS 2008). Live fascines—bundles of live plant material planted partially in the ground—can also serve the same purpose. Wattles can be made to varying diameters and lengths (Etra 2011). Wattles are used to break up slopes and reduce water velocity on the slope, protecting against sheet flow and concentrated water flow (Caltrans 2003; SWS 2008). They also help to reduce sediment loss by trapping water long enough for the sediment to settle out (SQH 2000). All slope stabilization work is to be completed before application of wattles and fascines, which are surface treatments for surface water and erosion control (Figure 22).



Wattles should be used immediately after grading and before seeding or mulching (SWS 2008). To install, dig a trench approximately half the diameter of the roll, place the roll in the trench, and use wooden stakes (SQH 2000) or live cuttings to anchor the roll. Anchors should be placed 2–3 ft apart (SQH 2000). Maintenance may include removing sediment built up on the upslope side, re-anchoring, or repairing or replacing split, torn, or unraveling rolls (Caltrans 2003; SWS 2008).

## Additional Resources for Wattles or Fiber Rolls

*California Stormwater BMP Handbook*, California Stormwater Quality Association, Menlo Park, 2003 [Online]. Available: [www.cabmphandbooks.com/Documents/Construction/SE-5.pdf](http://www.cabmphandbooks.com/Documents/Construction/SE-5.pdf).

Caltrans, *Statewide Stormwater Quality Practice Guidelines*, CTSW-RT-02-009, Sacramento, 2003.

Etra, J., 2011, “Fiber Roles or Sediment Logs: The Rest of the Story,” *Environmental Connection*, Vol. 5, No. 2, 2011, pp. 20–21.

Storm Water Services (SWS), Runoff Management, Fiber rolls/wattles (RM-10), Springfield, Mo., 2008 [Online]. Available: [www.sprfieldmo.gov/stormwater/pdfs/BMP%20PDFs/RM%20BMPs/FIBER%20ROLLS-WATTLES.pdf](http://www.sprfieldmo.gov/stormwater/pdfs/BMP%20PDFs/RM%20BMPs/FIBER%20ROLLS-WATTLES.pdf).

Stormwater Quality Handbooks (SQH), *Construction Site Best Management Practices (BMPs) Manual*, California Department of Transportation (Caltrans), Sacramento, Nov. 2000.

## STRAW BALE BARRIERS

A straw bale barrier is a linear sediment barrier consisting of straw bales designed to intercept and slow the flow of water and filter sediment-laden sheet flow runoff. Straw bale barriers allow sediment to settle from runoff before water leaves



FIGURE 22 A successful application of wattles on a stable cut slope (left); A failed application of wattles that were placed over an unstable, over-steep fill slope (right) (Courtesy: G. Keller).

a disturbed area. Straw bales are readily available in most locations. One disadvantage is that they are bulky and heavy when wet (Caltrans 2003).

Straw bale barriers are short-term erosion control measures that are best used at the base of a slope or down-slope of disturbed soil. Straw bale barriers can be placed around stockpiles, such as a stockpile of topsoil that will be used again later in the project, and can be used to protect drain inlets and ditch lines (Caltrans 2003).

Straw bale barrier maintenance may include replacing damaged straw bales, repairing washouts, or removing accumulated sediment behind the straw bale. The straw bales should be removed and accumulated sediment redistributed once work is complete (Caltrans 2003).

#### **Additional Resources for Straw Bale Barriers**

Caltrans, *Statewide Stormwater Quality Practice Guidelines*, CTSW-RT-02-009, Sacramento, 2003.

FHWA, *Best Management Practices for Erosion and Sediment Control*, FHWA-SLP-94-005, FHWA, Sterling, Va., 1995.

Goldman, S., K. Jackson, and T.A. Bursztynsky, *Erosion and Sediment Control Handbook*, McGraw Hill, New York, N.Y., 1986.

Keller, G. and J. Sherar, *Low-Volume Roads Engineering—Best Management Practices Field Guide*, Office of International Programs and U.S. Agency for International Development, USDA Forest Service, Washington, D.C., 2003 [Online]. Available: <http://www.fs.fed.us/global/topic/welcome.htm#12>.

#### **SILT FENCES**

Silt fences are a linear barrier of permeable fabric designed to intercept and slow the flow of sediment-laden runoff, allowing sediment to settle from the runoff before water leaves the site (Caltrans 2003). Silt fences are difficult to construct and maintain, and their use is for short-term maintenance only (Caltrans 2003). Although silt fences are widely used, they are often not installed correctly, not maintained, or not removed once the work is complete. Additionally, silt fences are made of nonbiodegradable materials.

Erosion control professionals have recently called for more stringent specifications to be placed on silt fence installation techniques (Sprague and Carpenter 2011). Currently two techniques, static slicing and trench-based installations, can be used to achieve maximum silt fence performance. Static slicing requires the insertion of a

narrow custom-shaped blade into the ground, while silt fence fabric is simultaneously pulled into the opening that is created. Four passes of a tractor tire are used to achieve appropriate compaction. Static slicing was pioneered by Iowa DOT in the 1990s and has been adopted by other midwestern states. Trench-based installation of silt fences requires that a trench be dug and cleaned out, fabric placed in the trench, and then the fabric buried and the trench compacted.

#### **Additional Resources for Silt Fences**

Caltrans, *Statewide Stormwater Quality Practice Guidelines*, CTSW-RT-02-009, Sacramento, 2003.

FHWA, *Best Management Practices for Erosion and Sediment Control*, FHWA-SLP-94-005, FHWA, Sterling, Va., 1995.

Goldman, S., K. Jackson, and T.A. Bursztynsky, *Erosion and Sediment Control Handbook*, McGraw Hill, New York, N.Y., 1986.

Keller, G. and J. Sherar, *Low-Volume Roads Engineering—Best Management Practices Field Guide*, Office of International Programs and U.S. Agency for International Development, USDA Forest Service, Washington, D.C., 2003 [Online]. Available: <http://www.fs.fed.us/global/topic/welcome.htm#12>.

Sprague, J. and T. Carpenter, “Silt Fence Installation Efficacy: Definitive Research Call for Toughening Specifications and Introducing New Technology,” International Erosion Control Association, Denver, Colo., 2011 [Online]. Available: [www.ieca.org/resources/documents/Article/ArticleSFInstallationEfficacy.asp](http://www.ieca.org/resources/documents/Article/ArticleSFInstallationEfficacy.asp)

#### **CHEMICAL SOIL STABILIZERS**

Chemical stabilization is an effective tool for temporary stabilization of surface soil. Vinyl, asphalt, rubber, anionic and nonionic polyacrylamide (PAM), and biopolymers are examples of chemical stabilizers that can be sprayed onto an exposed soil surface to hold the soil in place and minimize erosion from runoff and wind (EPA 2008). Chemical soil stabilizers can be used in areas where vegetation cannot be established, or on rough grading, cut and fill areas, temporary stockpiles, temporary or permanent seeding, or for site winterization, dormant seeding in the fall, staging areas, or other disturbed soils (IUM 2011).

When asked to provide an example of an underutilized tool, technique or method of erosion control, one respondent (Skip Ragsdale, personal communication, April 18, 2011) said,

Anionic polyacrylamide. There was a new Interstate project in which the sculpted road was going to sit unpaved from November through May. Usually they put three inches of gravel down for erosion control (estimated cost \$400,000) but instead they sprayed anionic PAM (cost \$3500) and they had no erosion issues at the site. [PAM is] very underutilized for short-term bare soil treatment.

PAM creates an electrochemical reaction that draws fine particles close together, making larger particles that are more resistant to erosion and large enough to settle from suspension (Cohn 2001). Historically, PAM has been used in agriculture to reduce soil loss in irrigation channels. When used for slope stabilization, PAM is only to be used where sheet flow is present. PAM is not to be used on slopes greater than 4:1 unless additional erosion-control measures such as mulch, geotextiles, or mats are used (IUM 2011). PAM should not be applied to frozen soil or where ice is present. It works best in soils with significant amounts of fine silts, clays, and colloidal particles, although overapplication can reduce soil infiltration rates. PAM breaks down over time, and areas of application need to be inspected regularly for signs of erosion. When applied to a soil surface for erosion control, PAM has been shown to reduce runoff volumes by 10% to 15%, further enhancing seed germination from additional water and aeration of soil.

Biopolymers that chemically stabilize soil include chitosan, cellulose and starch xanthates, and cellulose microfibrils (Orts et al. 2000). Chitosan, a naturally occurring polysaccharide, is derived from chitin in shellfish. Chitosan's ability to work is dependent on the pH of the water. Tests have shown optimal flocculation of suspended river silt and kaolinite at pH 7–7.5 (Divakaran and Sivasankara Pillai 2002). Historically, cellulose and xanthates have been used as soil stabilizers. Cotton microfibrils are a new product that shows potential for soil stabilization.

The U.S. Environmental Protection Agency (EPA) currently allows the use of PAM in water treatment. Some countries, including Japan, Germany, and the Netherlands, have banned or highly restricted its use in drinking water treatment. The EPA permits chitosan use in drinking water, waste water, and industrial water.

#### **Additional Resources for Chemical Soil Stabilizers**

Cohn, W., "Polyacrylamide (PAM) for Erosion Control Applications," presented at the Southeastern Pennsylvania Stormwater Management Symposium, 2001.

Divakaran, R. and V.N. Sivasankara Pillai, "Flocculation of River Silt Using Chitosan," *Water Research*, Vol. 36, 2002, pp. 2414–2418.

Illinois Urban Manual (IUM), Practice Standard, Polyacrylamide (PAM) for Temporary Soil Stabilization (no.) Code 893, 2011 [Online]. Available: <http://aiswcd.org/IUM/standards/urbst893.html>.

Nichols, E., Synthetic and Natural Cationic Polymers for Clarification of Environmental Water and the Significance of Cationicity, White paper, Scientific Director of Water Treatment Technologies.

Orts, W.J., R.E. Sojka, and G.M. Glenn, "Biopolymer Additives to Reduce Erosion-induced Soil Losses During Irrigation," *Industrial Crops and Products*, Vol. 11, No. 1, 2000, pp. 19–29.

Sojka, R.E., D.L. Bjorneberg, J.A. Entry, R.D. Lentz, and W.J. Orts, "Polyacrylamide in Agriculture and Environmental Land Management," *Advances in Agronomy*, Vol. 92, 2007, pp. 75–162.



## CHAPTER FOUR

**SOIL BIOENGINEERING AND BIOTECHNICAL TECHNIQUES**

This section summarizes literature and interview results on soil bioengineering and biotechnical stabilization techniques. Soil bioengineering is a technique that uses plants and plant material alone, whereas biotechnical techniques use plants in conjunction with more traditional engineering measures and structures to stabilize slopes (Gray and Sotir 1996; Schiechl and Stern 1996) and alleviate shallow, rapid landslides and eroding stream banks (Lewis et al. 2001). Both soil bioengineering and biotechnical techniques contribute to sustainable development practices, as they enhance the aesthetics of the highway environment and reduce the ecological impacts of highway construction, maintenance, and operations. In soil bioengineering systems, plants (grasses and shrubs, especially deep-rooted species) are an important structural component in reducing the risk of slope erosion (Jiang et al. 2004). Soil bioengineering measures are designed to aid or enhance the reestablishment of vegetation (USDA 1992). Properly designed and installed vegetative portions of systems should become self-repairing, with only minor maintenance to maintain healthy and vigorous vegetation. Soil bioengineering frequently mimics nature by using locally available materials and a minimum of heavy equipment, and is an inexpensive way to treat slope stabilization (Lewis et al. 2001).

“[Soil] bioengineering is a technique that has been used for decades in countries such as Nepal, or in other cases (e.g., in Pakistan) has been recently adopted as a viable soil stabilization method” (A. Faiz, personal communication, May 6, 2011).

Soil bioengineering has six main functions:

1. To *catch* eroded materials with physical barriers (e.g., walls, vegetation);
2. To *armor* the slope from erosion caused by runoff or rain splash using vegetative cover, partial armoring using lines of vegetation;
3. To *reinforce* soil physically with plant roots;
4. To *anchor* surface material to deeper layers using large vegetation with deep roots or rock bolts;
5. To *support* soil by buttressing with retaining walls or large vegetation; and
6. To *drain* excess water from the slope through the use of drains and vegetation (Howell 1999; Schor and Gray 2007).

When using soil bioengineering and biotechnical stabilization practices on slopes, consider a partnership among many disciplines, including soil scientists, hydrologists, botanists, engineering geologists, maintenance personnel, civil engineers, and landscape architects (Lewis et al. 2001). The following basic concepts will aid in selection of soil bioengineering and biotechnical treatments:

- Fit the system to the site. Consider topography, geology, soils, vegetation, and hydrology. Avoid extensive grading and earthwork in critical areas.
- Test soils to determine if amendments are necessary.
- Use on-site vegetation whenever possible.
- Limit the amount of disturbed areas at each site. Any materials removed from the site are to be kept on site and reused if possible.
- Clear sites during times of low precipitation.
- Stockpile or protect the topsoil and reuse during planting.
- Utilize temporary erosion and sediment control measures.
- Divert, drain, and/or store excess water (USDA 1992).

**PLANNING FOR SOIL BIOENGINEERING**

When *planning* to use soil bioengineering or biotechnical treatments for soil stabilization, the following design measures need to be considered: earthwork required to prepare the site, scheduling and timing of the work to ensure optimal timing for site construction and planting, appropriate use of vegetation to avoid damaging structures, and appropriate content and property of fill material to ensure that mechanical and hydraulic properties are met while supporting plant life. Soil bioengineering systems generally require minimal access for equipment and cause relatively minor site disturbance during installation (USDA 1992).

The *timing* of implementation of a soil bioengineered and biotechnical treatments is an important part of planning. Consider planting during the dormant season, usually

late fall, winter in temperate zones, or early spring (USDA 1992). Installation of live cuttings should begin concurrently with earthmoving operations if they are carried out during the dormant season. All construction operations are to be phased together when possible.

The selection of *plant species* is also important. First, the architectural features of plant root systems play a significant role in the effectiveness of plants in shallow slope stabilization and/or erosion control (Reubens et al. 2007). Second, wherever possible, native plant species (e.g., native multi-species grass sod) are preferred because they tend to tolerate drought; need little irrigation, fertilizer, pesticides, or herbicides; and demand less mowing (Dollhopf et al. 2008). Over time, highway agencies could see significant savings in labor, fuel, maintenance equipment costs, and reduced chemical use. Chen et al. (2009) reported that the use of native shrubs and grass species along with micro-environment improvements ensured the long-term viability of hydro-seeded vegetation along slopes in the arid Loess Plateau of China. Finally, mixture seeding is a desirable method of establishing a viable plant community for roadside slope protection. Chen et al. (2011) systematically evaluated 19 woody plants and 8 herbaceous plants in terms of their early growth ability, stress resistance, and growth potential once introduced to mild slopes along a freeway segment in Hubei, China. For this specific region, the field results indicated that the *Indigofera pseudotinctoria* and *Pinus massoniana* ranked the best and the worst, respectively. The authors suggested that the mixture seeding utilize woody plants featuring high stress resistance and outstanding growth potential as target species in conjunction with herbaceous plants featuring high early growth ability as protective species.

Soil bioengineering and biotechnical projects ideally use on-site stockpiled topsoil as the planting medium (USDA 1992). Soil bioengineering and biotechnical systems need to be installed in a planting medium that includes fines and organic material and is capable of supporting plant growth. It has been reported that “amendment of soils through the addition of topsoil is an important technique in roadfill revegetation in (semiarid) Mediterranean environments” (Tormo et al. 2007). Similarly, for slopes along the Qinghai–Tibet highway in the permafrost region of China, the vegetation established by local-topsoil-amended spray seeding was much better than that of ordinary spray seeding (Chen et al. 2009). The same study also found that the addition of more water retainer and soil stabilizer (instead of mulch) improved the performance of ordinary spray seeding. The selected soil backfill does not need to be organic topsoil, but enough organic material needs to be present to support plant growth. On-site soil should be tested for nutrient content, metals, and pH before the vegetation is installed. Soil around the vegetation should be compacted to densities approximating the surrounding natural soil densities, and soil around plants should be free of voids (USDA 1992).

“Initial failures of a small portion of a system normally can be repaired easily and inexpensively. Neglect of small failures, however, can result in the failure of large portions of a system” (USDA 1992).

Vegetation alone plays an important role in stabilizing slopes by intercepting and absorbing water, retaining soil below ground with roots and above ground with stems, retarding runoff velocity by providing a break in the path of the water and increasing surface roughness, and increasing water infiltration rates, soil porosity, and permeability (Schor and Gray 2007). Each type of vegetation serves a critical function. Grasses, or herbaceous cover, protects sloped surfaces from rain and wind erosion. Shrubs, trees, and other vegetation with deeper roots are more effective at preventing shallow soil failures, as they provide mechanical reinforcement and restraint with the roots and stems and modify the slope hydrology by root uptake and foliage interception (Schor and Gray 2007). Where the main function of structural elements is to allow vegetation to become established and take over the role of slope stabilization, the eventual deterioration of the structures is not a cause for concern (USDA 1992).

Field studies have shown instances where combined slope protection systems have proven to be more cost-effective than the use of vegetative treatments or structural solutions alone (USDA 1992). Lewis et al. (2001) found that where technically feasible, soil bioengineering alternatives can be adopted to produce equal or better economic and environmental results than the traditional geotechnical solutions alone. The average benefit-to-cost ratio in this study was 2.41, demonstrating that soil bioengineering can be a favorable economic alternative in roadside management. The cost of soil bioengineering at three sites in Washington State ranged from \$1.50 to \$3.50 per square foot (Lewis et al. 2001). Many interviewees stated that on slope stabilization projects in which they have participated, the overall cost of the soil bioengineering or biotechnical component represented about 1% of the total project budget.

Soil bioengineering and biotechnical treatments should not be considered the solution to every slope failure and surface erosion problem (USDA 1992). At some sites, hand seeding with grass seed will be the most cost-effective solution for the site, while at other sites a better solution may be an engineered retaining wall, with or without a vegetative component.

#### **Additional Resources for Soil Bioengineering and Biotechnical Techniques**

Andreu, V., et al., “Ecotechnological Solutions for Unstable Slopes: Ground Bio- and Eco-Engineering Techniques and Strategies,” In *Slope Stability and Erosion Con-*



*trol: Ecotechnological Solutions*, J.E. Norris, et al., Eds., Springer, Dordrecht, the Netherlands, 2008.

Atkins, R.J., M.R. Leslie, D.F. Polster, M.P. Wise, and R.H. Wong, *Best Management Practices Handbook: Hill-slope Restoration in British Columbia*, Resource Tenures and Engineering Branch, Victoria, BC Watershed Restoration Program, BC Ministry of Forests, 2001 [Online]. Available: <http://www.ieca.org/resources/federalstatewebsites.asp>.

Fox, P.J., T.H. Wu, and B. Trenner, *Bio-Engineering for Land Stabilization*, Final report prepared for the Ohio Department of Transportation, Columbus, 2010.

Gray, D.H. and R.B. Sotir, *Biotechnical and Soil Bioengineering Slope Stabilization: A Practical Guide for Erosion Control*, John Wiley & Sons, New York, N.Y., 1996.

Howell, J., *Roadside Bio-engineering: Site Handbook*, His Majesty's Government of Nepal. Ganabahal, Kathmandu, 1999 [Online]. Available: <http://onlinepubs.trb.org/Onlinepubs/sp/Airport/RoadsideBioengineering.pdf>.

Howell, J.H., S.C. Sandhu, N. Vyas, R. Sheikh, and S.S. Rana, *Introducing Bio-engineering to the Road Network of Himachal Pradesh*, The World Bank [Online]. Available: <http://himachal.gov.in/hpridc/RandD.pdf>.

Lewis, L., *Soil Bioengineering: An Alternative for Roadside Management A Practical Guide*, USDA-FS, T&DP, 0077 1801-SDTDC, U.S. Department of Agriculture, Washington, D.C., 2000.

Lewis, L., S.L. Salisbury, and S. Hagen, *Soil Bioengineering for Upland Slope Stabilization*, Report WA-RD 491.1, Washington State Department of Transportation, Olympia, 2001.

Ramakrishna, A.S., and D. Sapzova, *Using Bioengineering to Stabilize Landslide-Prone Hill Slides. Innovations in Development*, Mizoram Roads Project, The World Bank, India, 2011.

Schiechtl, H.M. and R. Stern, *Ground Bioengineering Techniques for Slope Protection and Erosion Control*, David H. Baker, U.K. Ed., translated by L. Jaklitsch, Wiley-Blackwell, Oxford, U.K., 1966.

Schiechtl, H., *Bioengineering for Land Reclamation and Conservation*, The University of Alberta Press, Edmonton, AB, Canada, 1980.

Schor, B. and D.H. Gray, *Landforming: An Environmental Approach to Hillside Development, Mine Reclamation and Watershed Restoration*, John Wiley & Sons, Hoboken, N.J., 2007.

USDA, *Natural Resources Conservation Service, National Engineering Handbook, Part 650, Engineering Field Handbook*, Chapter 18, "Soil Bioengineering for Upland Slope Protection and Erosion Reduction," USDA, Washington, D.C., 1992.

## LIVE STAKES

Live staking involves the insertion and tamping of live, rootable, vegetative cuttings into the ground (Figure 23) (USDA 1992). When correctly prepared and planted, or placed, the live stakes will root and grow. A system of stakes creates a living root mat that stabilizes the soil by reinforcing and binding soil particles together and by extracting excess soil moisture. In the United States, willow is a good woody plant that roots rapidly and begins to dry out a slope soon after installation (USDA 1992). Live stakes are an appropriate technique for repair of small earth slips and slumps that are frequently wet.



FIGURE 23 Live stake used to pin down matting (Courtesy: R. Sotir).

Live staking is a technique for relatively uncomplicated site conditions when construction time is limited and an inexpensive method is necessary (USDA 1992). Live staking can also be used to pin down, or anchor, erosion control materials on the surface. Live stakes are also well suited for stabilizing intervening areas between other soil bioengineering techniques, such as live fascines.

Live cuttings should be 0.5–1.5 in. in diameter (1.3–4 cm) and 2–3 ft long (0.6–1 m) (USDA 1992). Side branches are to be cleanly removed with bark intact. Basal ends are to be cut at a 45-degree angle for easy insertion into soil and the top is to be cut square. It is important that cuttings be installed as

soon as possible, ideally on the same day they are prepared. Spacing of cuttings should be 2–3 ft (0.6–1 m) apart in a triangular pattern with 2–4 per square yard (or meter), buds facing up (USDA 1992). Four-fifths of the length of the live stake should be installed in the ground and soil compacted around it after installation, with care taken not to split the stakes.

#### Additional Resources for Live Stakes

Shah, B.H., *Field Manual of Slope Stabilization*, United Nations Development Program, Pakistan, Sep. 2008 [Online]. Available: <http://www.preventionweb.net/english/professional/publications/v.php?id=13232>.

USDA, *Natural Resources Conservation Service, National Engineering Handbook*, Part 650, Engineering Field Handbook, Chapter 18, “Soil Bioengineering for Upland Slope Protection and Erosion Reduction,” USDA, Washington, D.C., 1992.

#### LIVE FASCINES

The word “fascine” means a bundle of sticks (Howell 1999). In this technique, bundles of live branches are laid in shallow trenches and partially buried. After burial in the trenches, they put out roots and shoots, forming a strong line of vegetation, also called live contour wattling. Live fascines mechanically reinforce the soil with roots, deplete soil water through transpiration and interception, and buttress the soil with the embedded stems (USDA 1992; Howell 1999). Live fascines also dissipate the energy of downward-moving water by trapping debris and providing a series of benches on which grasses, seedlings, and transplants establish more easily (USDA 1992). In certain locations, fascines can be angled to provide drainage (Howell 1999). Fascines immediately reduce surface erosion or rilling and are well suited for steep, rocky slopes where digging is difficult (USDA 1992).

Woody species, such as shrub willow or dogwood, are made into sausage-like bundles, which are generally oriented parallel to the slope contour (USDA 1992) (Figure 24). Portions of fascines will root and become part of the stabilizing cover. Live fascines provide an immediate increase in surface stability and can further improve soil stability to a depth of 1–3 ft (0.3–1 m) as the roots develop.

Fascines are best used on consolidated debris and fill slopes or soft cut slopes (Howell 1999). If the soil material is too hard, growth will be unacceptably slow. When time is an issue, brush layering may be a more appropriate option, as it establishes more quickly than fascines. Fascines can be used on slopes up to 45 degrees, whereas wattle fences can be used on slopes up to 30 degrees (Howell 1999). Contour fascines work well in well-draining materials; for poor-draining materials a herringbone pattern is suggested, as this pattern aids in drainage.



FIGURE 24 Live fascines (Courtesy: G. Keller).

The spacing of the fascines depends on slope steepness, but the following guidelines can be used generally:

Slopes less than 30 degrees	10–15 ft (3–4.5 m) intervals
Slopes 30 to 45 degrees	5–8 ft (1.5–2.5 m) intervals (Howell 1999).

Little or no maintenance is expected to be necessary for fascines with the exception of thinning established vegetation as needed over time (Howell 1999). Wattle fences are often too weak to support the volume of debris that is caught in them; fascines have been shown to be more effective (Howell 1999).

#### Additional Resources for Live Fascines

Howell, J., *Roadside Bio-engineering: Site Handbook*, His Majesty’s Government of Nepal. Ganabahal, Kathmandu, 1999 [Online]. Available: <http://onlinepubs.trb.org/Onlinepubs/sp/Airport/RoadsideBioengineering.pdf>.

Shah, B.H., *Field Manual of Slope Stabilization*, United Nations Development Program, Pakistan, Sep. 2008 [Online]. Available: <http://www.preventionweb.net/english/professional/publications/v.php?id=13232>.

USDA, *Natural Resources Conservation Service, National Engineering Handbook, Part 650, Engineering Field Handbook*, Chapter 18, “Soil Bioengineering for Upland Slope Protection and Erosion Reduction,” USDA, Washington, D.C., 1992.

#### BRUSH LAYERING AND PALISADES

To build brush layering systems, woody cuttings are laid in lines across the slope, generally following natural or



created contours (Howell 1999) (Figure 25). Brush layers form a barrier and prevent the development of rills, and trap sediment and debris moving down-slope. Brush layering is somewhat similar to live fascine systems in that both involve the cutting and placement of live branch cuttings on slopes, but the two techniques differ in the orientation of the branches and the depth to which they are placed in the slope (USDA 1992). In brush layering, the cuttings are oriented more or less perpendicular to the slope contour, similar to live stakes. The brush branches reinforce the slope, and the portions of the brush that protrude from the slope face assist in retarding runoff and reducing surface erosion (USDA 1992). The main function of brush layering is to catch debris and to armor and reinforce the slope (Howell 1999). After installation, over time a terrace or bench will develop. In certain locations, brush layers can be angled to create a drainage channel.



FIGURE 25 Brush layering with live stakes (Courtesy: R. Sotir).

Brush layering consists of placing live branch cuttings in small 2–3 ft (0.6–1 m) benches that have been excavated from the slope (USDA 1992). Bench excavation should start at the toe of the slope. The surface of the bench should be sloped so that the outside edge is higher than the inside. Live branch cuttings should be placed on the bench in a criss-cross or overlapping configuration with the brush growing

tips aligned toward the outside of the bench. Backfill is then placed on top of the branches and compacted to eliminate air spaces, with brush tips extending beyond the compacted fill. Each lower bench is backfilled with soil from excavating the bench above. Consider brush layering on slopes up to 2:1 in steepness and no greater than 15 ft (4.5 m) in vertical height (USDA 1992). Mulching between benches is suggested.

This technique can be used on a wide range of sites up to 45 degrees (Howell 1999). It is particularly effective on debris piles, fill slopes, and high embankments. Avoid using this technique on soils that drain poorly or that frequently slump.

Spacing between brush layering depends on the steepness of the slope (Howell 1999). The following guidelines can be used generally:

Slope less than 30 degrees	5–7 ft (1.5–2 m) intervals
Slope 30 to 45 degrees	3 ft (1 m) intervals
Slopes 30 to 60 degrees	3 ft (1 m) intervals (palisades only) (Howell 1999).

There is generally no need for maintenance except to replace failures if they occur, or to thin vegetation once it is established (Howell 1999). Brush layering can be complex, and careful tailoring to specific site and soil conditions may be needed (USDA 1992).

**Additional Resources for Brush Layering and Palisades**

Howell, J., *Roadside Bio-engineering: Site Handbook*, His Majesty’s Government of Nepal. Ganabahal, Kathmandu, 1999 [Online]. Available: <http://onlinepubs.trb.org/Onlinepubs/sp/Airport/RoadsideBioengineering.pdf>.

Shah, B.H., *Field Manual of Slope Stabilization*, United Nations Development Program, Pakistan, Sep. 2008 [Online]. Available: <http://www.preventionweb.net/english/professional/publications/v.php?id=13232>.

USDA, *Natural Resources Conservation Service, National Engineering Handbook, Part 650, Engineering Field Handbook*, Chapter 18, “Soil Bioengineering for Upland Slope Protection and Erosion Reduction,” USDA, Washington, D.C., 1992.

**BRANCH PACKING**

Branch packing consists of alternating layers of live branch cuttings and compacted backfill to repair small localized slumps and holes in slopes (USDA 1992) (Figure 26). This method is very similar to brush layering. The main differences between brush layering and branch packing is that

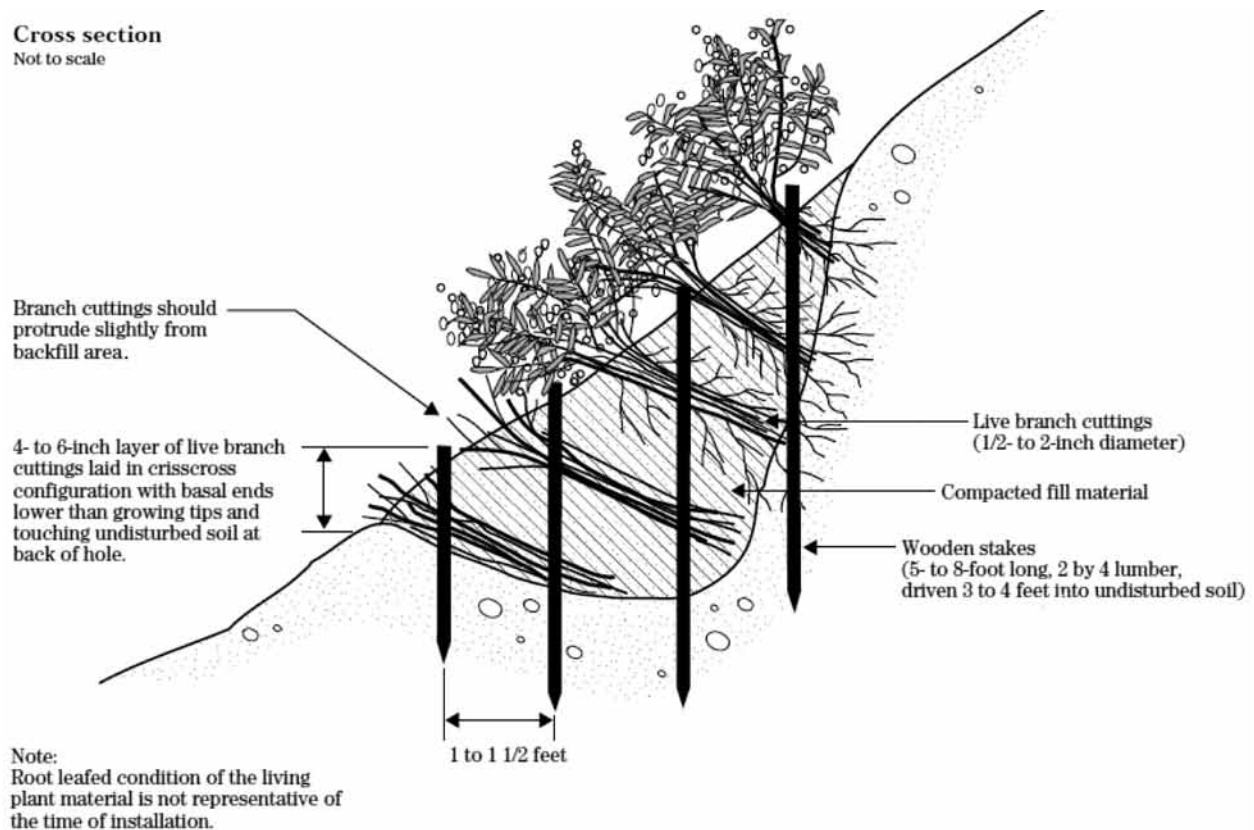

FIGURE 26 Cross section of branch packing (USDA 1992).

branch packing uses live material placed horizontally and inert material placed vertically into the slope and is better at repairing holes in embankments or small slumps.

Live brush cuttings should be 0.5–2 in. (1.3–5 cm) in diameter and long enough to reach the back of the trench and extend slightly from the slope surface (USDA 1992). Wooden stakes, the inert material, should be 5–8 ft (1.5–2.5 m) long poles that are 3–4 in. (7.5–10 cm) in diameter, or 2-by-4 lumber.

To install, start at the lowest point in the trench and drive the wooden stakes vertically 3–4 ft (1–1.5 m) into the ground, and set 1–1.5 ft (0.3–0.5 m) apart (USDA 1992). A layer of living branches 4–6 in. (10–15 cm) thick is placed in the bottom of the trench between the vertical stakes in a crisscross pattern with the growing tips pointing out. Each layer of branches is followed by a layer of compacted soil (USDA 1992). Soil should be moist or moistened to ensure that the live branches do not dry out. Branch packing is not effective in areas where slumping is greater than 4 ft (1.2 m) deep or 5 ft (1.5 m) wide (USDA 1992).

Another method, called live gully repair (Sotir and Gray 1992, p. 28), is a combination of brush layering and branch packing. Live gully repair utilizes alternating layers of live branch cuttings and compacted soil to repair small rills and gullies (USDA 1992). For additional information on this

technique, see Natural Resources Conservation Service, *Engineering Field Handbook*, page 28 (USDA 1992).

#### Additional Resources for Branch Packing

Shah, B.H., *Field Manual of Slope Stabilization*, United Nations Development Program, Pakistan, Sep. 2008 [Online]. Available: <http://www.preventionweb.net/english/professional/publications/v.php?id=13232>.

USDA, *Natural Resources Conservation Service, National Engineering Handbook, Part 650, Engineering Field Handbook*, Chapter 18, “Soil Bioengineering for Upland Slope Protection and Erosion Reduction,” USDA, Washington, D.C., 1992.

#### ROCK JOINT PLANTING

Joint planting or vegetative riprap involves planting live cuttings into soil between the joints or open spaces between rocks that have been placed on a slope (Figure 27) (USDA 1992). Joint planting works well with rock blankets and rock walls. This technique is very similar to live stakes. A steel rod or pry bar is used to open up a hole in the rock. Then the live stake is placed into the hole and driven into the ground. This will also punch a hole through any geotextile filter layer behind the rock.





FIGURE 27 Rock joint planting (Courtesy: R. Sotir).

Roots from the plants will improve drainage by removing soil moisture, and over time create a living root mat in the soil base and around rocks (USDA 1992). The root system of the mat will help to bind or reinforce the soil and to prevent loss of fines between and below the rocks (USDA 1992).

The live cuttings should be 0.5–1.5 in. (1.2–4 cm) in diameter, long enough to extend into the soil behind the rock surface, and have the branches removed (USDA 1992). To install, plant live branch cuttings into the openings of the rock during or after construction by tamping them with a soft mallet or by hand. Orient the live cuttings perpendicular to the slope with growing tips protruding slightly from the finished face of the rock.

**Additional Resources for Rock Joint Planting**

Kling, P., M. Pyles, D. Hibbs, and B. Kauffman, *The Role of Vegetated Riprap in Highway Applications*, Final Report SPR 324, Federal Highway Administration. Washington, D.C., 2001.

USDA, *Natural Resources Conservation Service, National Engineering Handbook, Part 650, Engineering Field Handbook*, Chapter 18, “Soil Bioengineering for Upland Slope Protection and Erosion Reduction,” USDA, Washington, D.C., 1992.



**LIVE AND TIMBER CRIB WALLS**

A live crib wall consists of a hollow, boxlike interlocking arrangement of untreated log or timber members (Figure 28) (USDA 1992). The structure is filled with suitable backfill material and layers of live branch cuttings, which root inside the crib structure and extend into the slope (NRCS 1992). Once the live cuttings root and become established, the resulting vegetation gradually takes over the structural function of the wood members (USDA 1992). Crib walls provide immediate erosion protection, while the established vegetation provides long-term stability.

The technique is appropriate at the base of a slope where a low wall may be needed to stabilize the toe of the slope, to prevent small failures, and to reduce its steepness (USDA 1992). Crib walls are useful where space is limited and a more vertical structure is needed (USDA 1992). Timber crib walls cost less to construct than concrete crib walls, especially when timber can be harvested or gathered from the site (Shah 2008). Crib walls are not designed or intended to resist large, lateral earth stresses (USDA 1992).



FIGURE 28 Live crib wall, from a distance (left) and close up (right) (Courtesy: G. Keller).

To install a crib wall, start at the lowest point and excavate loose material down 2–3 ft (0.6–1 m) until the foundation is stable (USDA 1992). Excavate the back of the stable foundation, at the slope, slightly deeper than the front; this will add stability to the structure. Crib walls are to be built with round or square timbers, 4–10 in. (10–25 cm) in diameter (USDA 1992; Shah 2008). Place the first course of logs or timber at the front and back about 4–5 ft (1.2–1.5 m) apart and parallel to the slope contour (USDA 1992). Place the next course of logs or timbers at right angles, or perpendicular, to the slope on top of the previous course, allowing 3–6 in. (7.5–15 cm) of overhang. Repeat these steps for each additional course of crib wall, securing each course with nails or rebar.

As the crib wall structure is built up, beginning at ground level, place live branch cuttings on the backfill perpendicular to the slope, cover the cuttings with backfill, and compact it (USDA 1992). Live branch cuttings should be 0.5–2 in. (1.2–5 cm) in diameter and long enough to reach the back of the wooden crib structure, with less than 10 in. (25 cm) protruding from the wall (USDA 1992; Shah 2008). Live branch cuttings should be placed on each course to the top of the crib wall with growing tips coming out of the face of the crib wall (USDA 1992). When the fill material is tamped into openings between the poles, large hollow spaces should be avoided to ensure that the branches will root properly (Shah 2008). Vegetation should be planted at a density of 10 live stakes per 3 ft (0.9 m) or as necessary. This may vary with the type of vegetation used for cuttings and the slope steepness.

The constructed crib wall should be tilted back, or battered, if the system is built on a smooth, evenly sloped surface (USDA 1992). Crib walls can also be constructed in a stair-step fashion so that each successive level of timber is set back 6–10 in. (15–25 cm) toward the slope face at a 1:10 angle toward the slope, but never placed vertically (USDA 1992; Shah 2008). Crib walls are to be constructed to a maximum height of 6–10 ft (2–3 m).

Live crib walls can be complex, and careful tailoring to specific site and soil conditions may need to be considered (USDA 1992).

#### Vegetated Concrete Crib Walls

Another option is a vegetated concrete crib wall (Figure 29). Prefabricated concrete slabs or hollow bricks are used to create the wall (Shah 2008; Zhang and Chen 2008). There are different types of concrete crib walls, but generally 4-ft-long (1.2-m-long) concrete slabs are prepared that are 6 in. (15 cm) thick and 1 ft (30 cm) thick at both ends (Shah 2008). The footer slabs have sockets on both sides and the header slabs have convex ends on both sides (Shah 2008).



FIGURE 29 Post-earthquake (2005) slope stabilization using a masonry crib wall and layered planting of native trees and bushes, Balakot-Kaghan Road (N-15), Pakistan (Courtesy: A. Faiz).

To build a vegetated concrete crib wall:

- Clear and excavate material from the site to create a solid base.
- Place concrete slabs to create a solid foundation.
- Place the concrete slabs at a 1:5 slope gradient, sloping back toward the slope face.
- Build up the wall by placing the footers parallel to the slope with 2-ft (0.6-m) gaps between each concrete slab.
- Place headers over footers.
- Fill soil in the gaps between the concrete slabs.
- Plant cuttings in the gaps between the concrete slabs.
- Drainage should be considered at the base of the wall (Shah 2008).

#### Additional Resources for Live and Timber Crib Walls

Shah, B.H., *Field Manual of Slope Stabilization*, United Nations Development Program, Pakistan, Sep. 2008 [Online]. Available: <http://www.preventionweb.net/english/professional/publications/v.php?id=13232>.

USDA, *Natural Resources Conservation Service, National Engineering Handbook, Part 650, Engineering Field Handbook*, Chapter 18, “Soil Bioengineering for Upland Slope Protection and Erosion Reduction,” USDA, Washington, D.C., 1992.

#### VEGETATED ROCK GABIONS

Vegetated gabions begin as rectangular containers fabricated from a triple-twisted, hexagonal mesh of heavily galvanized steel wire (USDA 1992). Empty gabions are placed in position, wired to adjoining gabions, filled with stones, and then folded shut and wired at the ends and sides. Live branches



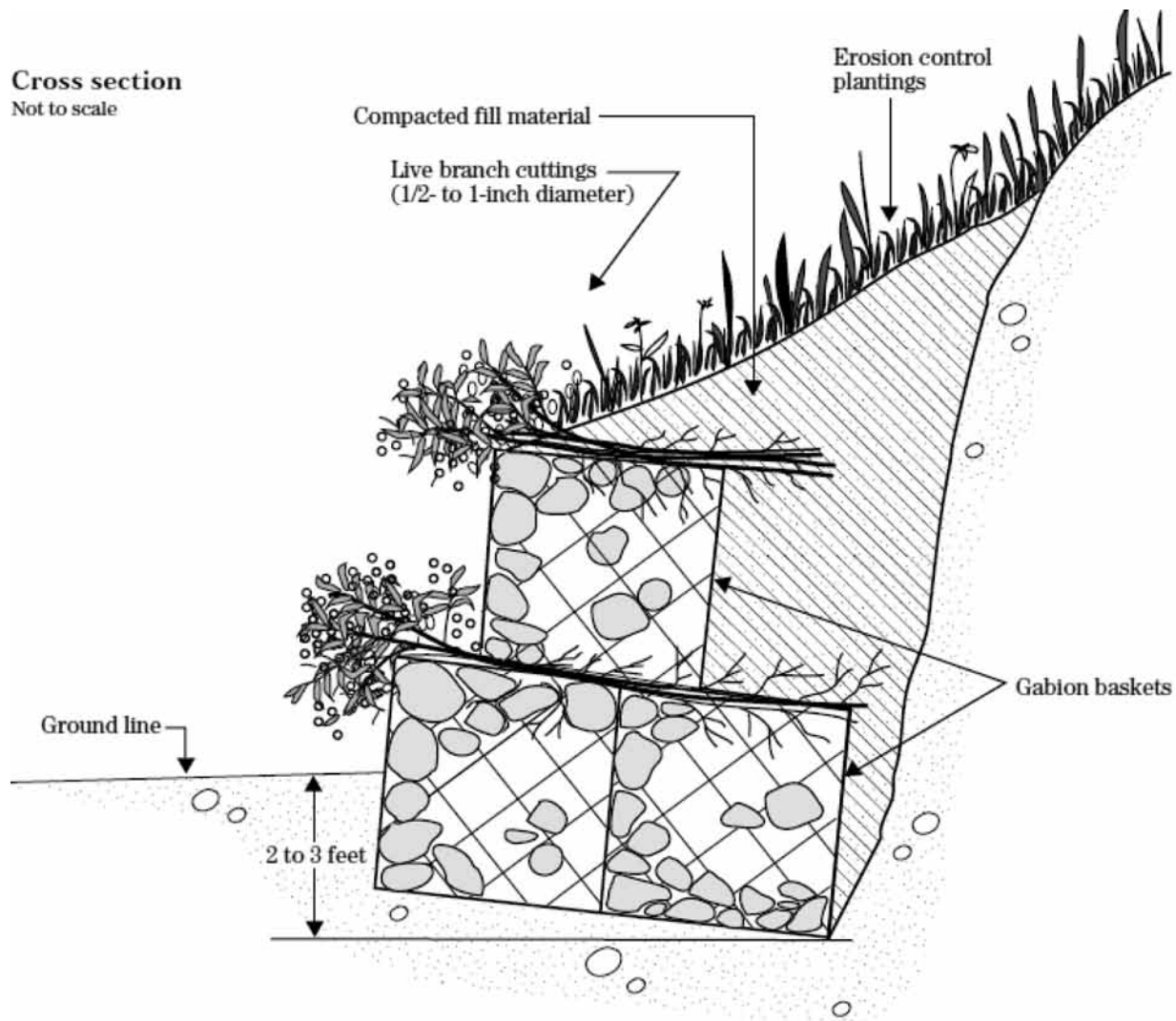

**Note:**  
 Rooted/leafed condition of the living plant material is not representative of the time of installation.

FIGURE 30 Cross section of a vegetated gabion wall (USDA 1992).

are placed on each consecutive layer between the rock-filled baskets (Figure 30). These will take root inside the gabion baskets and in the soil behind the structures (USDA 1992). In time, roots consolidate the structure and bind it to the slope.

The technique is appropriate for the base of a slope where a low wall may be necessary to stabilize the toes of the slope and reduce its steepness (USDA 1992). This technique is not designed or intended to resist large, lateral earth stresses. It is important that the gabion wall be constructed to a maximum height of 5 ft (1.5 m), including the excavated foundation. This technique is used where space is limited and a more vertical structure is required. Cuttings used should be 0.5–1 in. (1.3–2.5 cm) in diameter and long enough to reach beyond the back of the rock basket structure into the backfill (USDA 1992).

To install, start at the lowest point of the slope and excavate loose material 2–3 ft (0.6–0.9 m) below the ground surface to create a stable foundation (USDA 1992). Excavate the back of the stable foundation, closest to the slope, slightly deeper than the front to add stability to the structure. Place gabion wire baskets in the bottom of the excavation pit and fill with rock. Place backfill between and behind the wire baskets. Place live branch cuttings on the wire baskets perpendicular to the slope with the growing tips oriented away from the slope extending slightly beyond the gabion baskets (USDA 1992). Extend the live cuttings beyond the backs of the wire baskets into the fill material. Place soil over the cuttings and compact it. Repeat this sequence until the structure reaches the appropriate height (USDA 1992) (Figure 30).



Gabion walls are strengthened by trees growing on them (Howell 1999). There are two types of gabions: stone-filled and earth-filled. Vegetated stone gabions tend to come about naturally where trees have seeded existing gabion walls, although they could be seeded artificially. There is little concern for distortion of the wire gabion boxes (Howell 1999). The benefit is that the trees will provide flexible binding to the structure once the wire has corroded. For stone-filled gabions, trees are unlikely to contribute much to the strength of the structure until the wire has become seriously corroded.

Vegetated earth-filled gabions are a lower-cost alternative to stone-filled gabions (Howell 1999). They are created by placing a fill of in-situ earth behind a single layer of dry stone within the gabion basket (Howell 1999). Tree seedlings are then planted on the gabion (Howell 1999). Plants should be spaced 1.5 ft (0.5 m) in a random pattern (Howell 1999). Maintenance may include thinning of vegetation to maintain the site. This technique is not widely studied or implemented.

**Vegetated Soft Gabion Wall**

Another technique, called vegetated soft gabion walls, has been used successfully in Pakistan (Figure 31) (Shah 2008). Soft gabions are made of jute or synthetic fiber bags, originally used for fertilizer or sugar, which are filled with soil or aggregate and placed to create a soft retaining wall. This technique can be used where stones are not available for gabion construction.



FIGURE 31 Vegetated soft gabion wall (Shah 2008).

The steps to create a vegetated soft gabion wall are as follows (Shah 2008):

- Clear the area where the wall will be built and excavate the base to a solid soil layer.
- Fill the empty bags with soil or aggregate, and place the filled bags side by side with their open ends directed toward the cut slope.

- Push soil from slope onto the bags and cover them fully.
- Place a layer of fresh cuttings on the soil surface with ends directed toward the slope.
- Cover the cuttings with another layer of soil from the slope.
- Place another layer of soil-filled bags lengthwise over the buried cuttings set back 6 in. (15 cm) from the front of the first layer of bags.
- Place another layer of soil over the bags and put down another layer of cuttings, bury with soil, and repeat this process until the wall height is achieved.
- Establish proper drainage at the base of the wall.

Maintenance may include cutting back or pruning the established plants.

**Additional Resources for Vegetated Rock Gabions**

Howell, J., *Roadside Bio-engineering: Site Handbook*, His Majesty’s Government of Nepal. Ganabahal, Kathmandu, 1999 [Online]. Available: <http://onlinepubs.trb.org/Onlinepubs/sp/Airport/RoadsideBioengineering.pdf>.

USDA, *Natural Resources Conservation Service, National Engineering Handbook*, Part 650, Engineering Field Handbook, Chapter 18, “Soil Bioengineering for Upland Slope Protection and Erosion Reduction,” USDA, Washington, D.C., 1992.

**VEGETATED ROCK WALLS**

A vegetated rock wall is a combination of rock and live branch cuttings used to stabilize and protect the toe of steep slopes (USDA 1992) (Figure 32). Vegetated rock walls differ from conventional retaining structures in that they are placed against relatively undisturbed earth and are not intended to resist large lateral pressures.

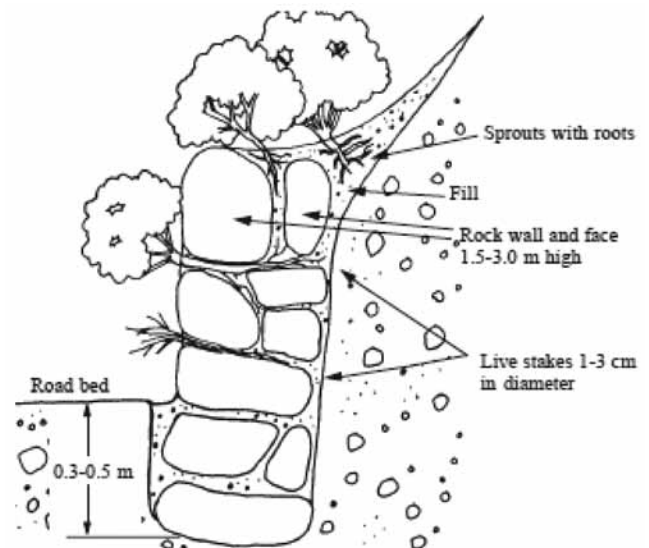

FIGURE 32 Cross section of a vegetated rock wall (Keller and Sherar 2003).

Vegetated rock walls are appropriate where a low wall may be needed to stabilize the toe of the slope and reduce its steepness. Vegetated rock walls are useful where space is limited and natural rock is available (USDA 1992).

To build a vegetated rock wall, live cuttings should be 0.5–1 in. (1.2–2.5 cm) in diameter and long enough to reach beyond the rock structure into the fill or undisturbed soil behind the structure (USDA 1992). Rocks used should be 8–24 in. (20–60 cm) in diameter, with larger boulders used at the base.

To install, start at the lowest point of the slope, and remove loose soil until a stable base is reached, generally 2–3 ft (0.6–1 m) below the ground elevation (USDA 1992). Excavate the back of the stable foundation, closest to the slope, slightly deeper than the front to add stability to the structure. Excavate the minimum amount from the existing slope to provide a suitable recess for the wall. Well-draining base material needs to be used if deep frost penetration may be an issue. Place rocks with at least three load-bearing points contacting the foundation material or underlying rock course (USDA 1992). They should also be placed so that their center of gravity is as low as possible, with the long axis slanting inward toward the slope

if possible. When a rock wall is constructed adjacent to an impervious structure, place a drainage system at the back of the foundation and outside the toe of the wall to provide an appropriate drainage outlet (USDA 1992). The overall height of the rock wall including the excavated base should not exceed 5 ft (1.5 m).

A wall can be constructed with a sloping bench behind it to provide a base on which live branch cuttings can be placed during construction (USDA 1992). Live cuttings should be tamped or placed into the openings of the rock wall during or after construction. The base ends of the branches should extend into the backfill or undisturbed soil behind the wall. Live cuttings should be oriented perpendicular to the slope contour with growing tips protruding slightly from the finished wall face (USDA 1992).

#### **Additional Resources for Vegetated Rock Walls**

USDA, *Natural Resources Conservation Service, National Engineering Handbook*, Part 650, Engineering Field Handbook, Chapter 18, “Soil Bioengineering for Upland Slope Protection and Erosion Reduction,” USDA, Washington, D.C., 1992.

## CHAPTER FIVE

**MECHANICAL STABILIZATION TECHNIQUES**

This section summarizes literature and interview results on mechanical stabilization techniques. This chapter provides information about techniques that use nonvegetative or nonliving components such as rock, concrete, geosynthetics, and steel pins to reinforce slopes. These techniques can provide stability to both cut and fill slopes. Structures are generally capable of resisting much higher lateral earth pressures and shear stresses than vegetation (USDA 1992). Similarly, as demonstrated by nonlinear finite element analysis, polymeric reinforcement within a soil slope can alter the probable failure mechanism within the slope, significantly reducing the shearing, horizontal, and vertical strains and greatly reducing slope movements (Chalaturnyk et al. 1990). It is important to note that multiple failure mechanisms are possible. When designing a structural wall and determining reinforcement lengths, care must be taken to check other failure surfaces and modes (B. River, personal communication, Nov. 7, 2011). Depending on the soil type, tensile strength and aspect ratio of fibers, volumetric fiber content, and so on, the inclusion of fiber reinforcement in soil can induce distributed tension within the soil, and the soil failure can be governed by pullout or breakage of individual fibers (Zornberg 2002). Including anchors in slopes can enhance the safety factor by providing an additional shearing resistance on the slip surface, which is a function of the orientation, position, and spacing of anchors (Cai 2003). Depending on the slope to be stabilized, reinforced soil slope techniques would be tailored to address the specific site challenges. To implement reinforced soil slope techniques, one can first assess the additional shear force needed for slope stability (indicated by the design safety factor) and then analyze the available forces provided by the reinforcement layers or anchors, followed by the selection of the type, number, location, or spacing of the reinforcement within the slope. The life cycle performance of the reinforcement materials has to be considered at the design stage, as such materials may deteriorate over time in the soil owing to exposure to environmental and mechanical loadings (Jewell and Greenwood 1988).

The following sections describe various reinforced soil slope techniques, which may be used individually or in combination for slope stabilization.

**RETAINING WALLS**

Retaining structures are used to hold back (retain) material at a steep angle and are very useful when space (or right-of-

way) is limited. Low retaining structures at the toe of a slope make it possible to grade the slope back to a more stable angle that can be successfully revegetated without loss of land at the crest (USDA 1992). Such structures can also protect the toe against scour and prevent undermining of the cut slope (Gray and Sotir 1996). Short structures at the top of a fill slope can provide a more stable road bench or extra width to accommodate a road shoulder.

Retaining structures can be built external to the slope (such as a concrete or masonry retaining wall), or utilize reinforced soil (such as a burrito wall or deep patch). Although some of these techniques can apply to large failures, the focus of this synthesis is on shallow instabilities and appropriate low-cost, sustainable solutions, and so this section will focus on smaller applications.

**Low Masonry or Concrete Walls (With Slope Planting)**

Masonry or poured concrete retaining walls are rigid structures that do not tolerate differential settlement or movement and are appropriate only at sites where little additional movement is expected. Because of this limitation, their use is more restricted than gabion walls or reinforced soil systems. Masonry or concrete walls can have various cross sections (Figure 33). Gravity walls can be constructed with plain concrete, stone masonry, or concrete with reinforcing bar. Masonry walls that incorporate mortar and stone are easier to construct and stronger than dry stone masonry walls, but they do not drain as well (Hearn and Weeks 1997). Cantilever walls use reinforced concrete and have a stem connected to a base slab (Das 2007).



FIGURE 33 Cross section of gravity (left) and cantilever (right) retaining walls (Adapted from Das 2007).

Figure 34 shows a schematic of a low cantilever retaining wall used to flatten a slope and establish vegetation. Retain-

**Cross section**  
Not to scale

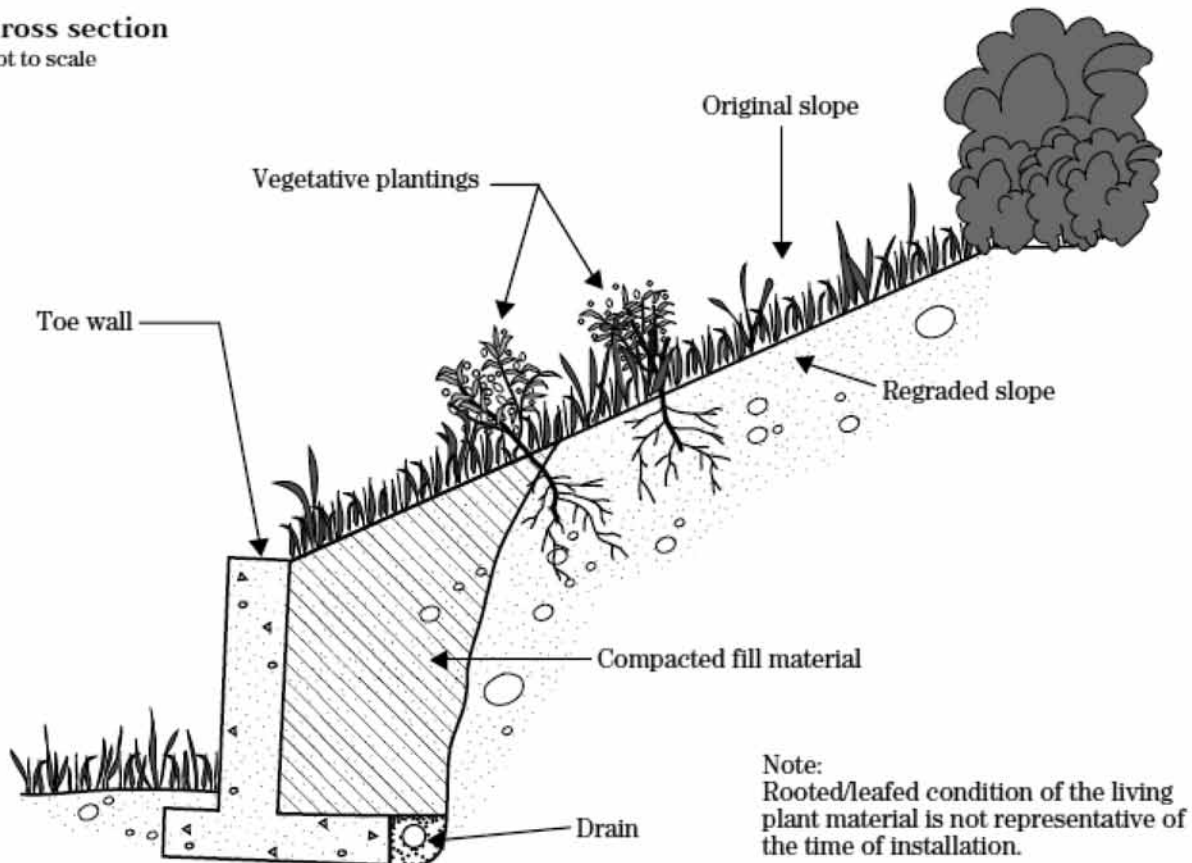

FIGURE 34 Cross section of a low wall with vegetation planted on the slope for stabilization (USDA 1992).

ing walls with free-draining compacted backfill can be designed and constructed more efficiently than those using poor-quality, cohesive backfill soils. In either case, a drainage system should be installed behind the wall (Anderson et al. 1997; Das 2007; Shah 2008).

The decision to use a dry masonry, mortared masonry, or concrete retaining wall will be greatly influenced by the familiarity and experience of local practitioners. Reinforced concrete is very common in the United States, and there is no shortage of engineers or contractors with adequate experience to design and construct concrete retaining walls. In developing countries with larger labor pools and experienced masons, dry masonry or mortared masonry structures are more common (Anderson et al. 1997; Shah 2008).

**Additional Resources for Retaining Walls**

Das, B.M., *Principles of Foundation Engineering*, 6th ed., Cengage Learning, Stamford, Conn., 2007, 750 pp.

Hearn, G.J. and R.W. Weeks, *Principles of Low Cost Road Engineering in Mountainous Regions*, with special reference to Nepal, Himalaya, C.J. Lawrence, Ed., Transportation Research Library Overseas Road Note 16, Berkshire, United Kingdom, 1997.

Keller, G. and J. Sherar, *Low-Volume Roads Engineering—Best Management Practices Field Guide*, Office of International Programs and U.S. Agency for International Development, USDA Forest Service, Washington, D.C., 2003 [Online]. Available: <http://www.fs.fed.us/global/topic/welcome.htm#12>.

Mohoney, J., et al., *Retaining Wall Design Guide*, Publication No. FHWA-FLP-94-006, Federal Lands Highway Technology Implementation Program. Washington, D.C., Sep. 1994.

Shah, B.H., *Field Manual of Slope Stabilization*, United Nations Development Program, Pakistan, Sep. 2008 [Online]. Available: <http://www.preventionweb.net/english/professional/publications/v.php?id=13232>.

Sotir, R.B. and M.A. McCaffrey, “Stabilization of High Soil and Rock Cut Slope by Soil Bioengineering and Conventional Engineering,” *Transportation Research Record 1589*, Transportation Research Board, National Research Council, Washington, D.C., 1997, pp. 92–98.

**Gabion Walls**

Gabion baskets are made of heavy wire mesh and assembled on site, set in place, then filled with rock. Once the rock has

been placed inside the gabion basket, horizontal and vertical wire support ties are used to achieve the reported strength. Gabion walls are composed of stacked gabion baskets and are considered unbound structures. Their strength comes from the mechanical interlock between the stones or rocks (Hearn and Weeks 1997). To achieve the maximum level of strength in the gabion wall, the baskets are to be filled to the greatest possible density, which is generally achieved by hand packing rather than mechanically packing. Packing of the gabion baskets is a skill that is learned through practice. For specific information about how to pack rock, rock types to be used, and wire mesh gauges and tying (see Hearn and Weeks 1997, pp. 121–122).

Gabion basket manufacturers have a wealth of standard designs for various wall heights and soil types that ensure stability against overturning, sliding, bearing-capacity failure, and deep-seated slope failure (Kandaris 1999). Gabion walls can be used at the toe of a cut slope or the top of a fill slope (Figure 35). The walls can be vertical or stepped and are adaptable to a wide range of slope geometries (Kandaris 1999). Gabion walls can accommodate settlement without rupture and provide free drainage through the wall. They are usually preferred at sites with poor foundations, wet soils, high groundwater, or slope movement caused by creep, sliding, and seismicity (Hearn and Weeks 1997).

#### Useful Points

- We have had issues with contractors not knowing how to load gabion baskets or not installing gabion basket cross ties. Cross ties should be installed every foot in both directions; otherwise the gabion basket will not achieve the design strength (B. Johnson, personal communication, April 18, 2011).



FIGURE 35 Low gabion wall and gabion wall stabilization at top of fill slope in Timor (Courtesy: G. Keller and C. Bennett).

#### Additional Resources for Retaining Walls

Hearn, G.J. and R.W. Weeks, *Principles of Low Cost Road Engineering in Mountainous Regions*, with special ref-

erence to Nepal, Himalaya, C.J. Lawrence, Ed., Transportation Research Library Overseas Road Note 16, Berkshire, United Kingdom, 1997.

Keller, G. and J. Sherar, *Low-Volume Roads Engineering—Best Management Practices Field Guide*, Office of International Programs and U.S. Agency for International Development, USDA Forest Service, Washington, D.C., 2003 [Online]. Available: <http://www.fs.fed.us/global/topic/welcome.htm#12>.

Shah, B.H., *Field Manual of Slope Stabilization*, United Nations Development Program, Pakistan, Sep. 2008 [Online]. Available: <http://www.preventionweb.net/english/professional/publications/v.php?id=13232>.

### MECHANICALLY STABILIZED EARTH/GEOSYNTHETIC REINFORCED SOIL SYSTEMS

Retaining walls can also be built with reinforced soil. These are commonly referred to as mechanically stabilized earth (MSE) walls. MSE walls can use different reinforcing elements (e.g., strips of metal, sheets of geosynthetics) and different facing systems (e.g., concrete panels, modular blocks, shotcrete). Geosynthetic reinforced slopes can also retain soil to, for example, support a road bench. The technology has been around long enough to be thoroughly studied with computer models (e.g., Karpurapu and Bathurst 1995, Vulova and Leshchinsky 2003; Hatami and Bathurst 2005); laboratory experiments (e.g., Helwany 1994; Zornberg et al. 1998; Wu and Helwany 2001), and field studies (Tatsuoka et al. 1992; Liang and Almoh'd 2004; Abele 2006).

There is still some debate in the geotechnical engineering community about the fundamental theory of the behavior of MSE walls and reinforced soil slopes (VanBuskirk 2010, Adams et al. 2011). In any case, several techniques have been shown over the years to be cost-effective and sustainable solutions to slope instabilities. The following specific techniques are presented in more detail: shallow MSE walls, geotextile walls, reinforced soil slopes, and deep patch embankment repair.

#### Shallow Mechanically Stabilized Earth Walls

MSE walls are constructed with reinforced soil (Figure 36). The reinforcement can be metal strips (galvanized or epoxy-coated steel), welded wire steel grids, or geogrids. The walls have a vertical or near-vertical face and include a facing system to prevent raveling and erosion. The facing elements could be precast concrete panels, modular concrete blocks, metal sheets, gabions, welded wire mesh, shotcrete, or wood lagging and panels. Hybrid systems are common; for example, a geogrid-reinforced MSE wall with gabion-basket facing was used at several locations along a new highway in



Nantahala National Forest in North Carolina (Simac et al. 1997). A variety of proprietary facing reinforcement systems exist, but because most process patents for MSE walls have expired, many options exist for contractors to purchase and erect them. MSE walls can be designed and built to accommodate complex geometries and to heights greater than 80 ft. They offer several advantages over gravity and cantilever concrete retaining walls: simpler and faster construction, less site preparation, lower cost, more tolerance for differential settlement, and reduced right-of-way acquisition (Elias et al. 2001).

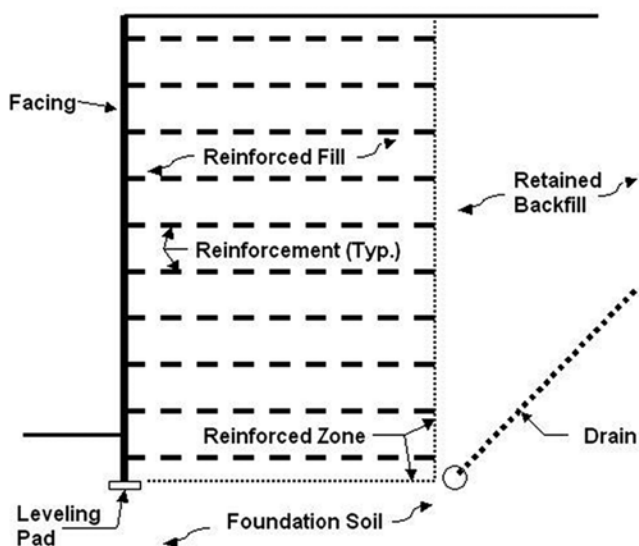

FIGURE 36 Schematic of a generic mechanically stabilized earth wall (Berg et al. 2009).

Although the economic savings of MSE walls compared with traditional concrete retaining walls are significantly better at heights greater than 10 ft, even short MSE walls can be constructed economically. For shallow walls, the less expensive option is usually modular block facing, as opposed to precast concrete or metal sheet (Elias et al. 2001). Consider using good-quality backfill material, especially for high walls and bridge abutments, although shorter walls can more easily tolerate poorer quality soils.

“[The most cost-effective road slope stabilization technique is] shallow MSE walls, by far and away, because you use native materials and you don’t need specialized contractors to do it. We got away from steel strip reinforcement a long time ago. Now we mostly use welded wire because it’s easy to install” (S. Romero, personal communication, May 11, 2011).

#### Additional Resources for MSE Walls

Berg, R., B. Christopher, and N. Samtani, *Design of Mechanically Stabilized Earth Walls and Reinforced Soil Slopes*, Volumes 1 and 2, FHWA-NHI-10-024 and 025, Fed-

eral Highway Administration, U.S. Department of Transportation, Washington, D.C., 2009.

Elias, V., B. Christopher, and R. Berg, *Mechanically Stabilized Earth Walls and Reinforced Soil Slopes Design and Construction Guidelines*, Report FHWA-NHI-00-043, Federal Highway Administration, Washington, D.C., 2001.

#### Geotextile Walls

Geotextile-wrapped walls, sometimes called burrito walls, were developed by the U.S. Forest Service in the Pacific Northwest as a low-cost alternative to walls requiring facing elements. Geotextile walls are used to stabilize the fill slope by placing sheets of geotextile between layers of soil (pit run or road base) that are usually 6–18 in. (15–50 cm) thick (Figure 37). The geotextile is wrapped at the face; temporary forms or careful compaction can be used before flipping the geotextile over the soil (Powell et al. 1999). Figure 37 shows two examples of geotextile walls. Because the geotextile face can degrade from sunlight and ultraviolet radiation, consider protecting the geotextile unless the wall is constructed as a temporary structure (service life of about 3 years or less). A layer of gunite (cement, sand, and water mixture) or asphalt emulsion can provide adequate protection (Powell et al. 1999). Vegetation can also shade the geotextile sufficiently. To vegetate a geotextile wall, seeds are sown on the outer face of the soil before wrapping the front with the geotextile; cuttings are also placed in the thin soil layer between sheets of reinforcement (Shah 2008).

#### Useful Points

- There is a learning curve to creating these the first time and without forms. Using a contractor who has experience in the technique of building a geotextile wall will help (J. Currey, personal communication, April, 15, 2011).

#### Additional Resources for Geotextile Walls

Elias, V., B. Christopher, and R. Berg, *Mechanically Stabilized Earth Walls and Reinforced Soil Slopes Design and Construction Guidelines*, Report FHWA-NHI-00-043, Federal Highway Administration, Washington, D.C., 2001.

Keller, G. and J. Sherar, *Low-Volume Roads Engineering—Best Management Practices Field Guide*, Office of International Programs and U.S. Agency for International Development, USDA Forest Service, Washington, D.C., 2003 [Online]. Available: <http://www.fs.fed.us/global/topic/welcome.htm#12>.

Powell, W., G.R. Keller, and B. Brunette, “Applications for Geosynthetics on Forest Service Low-Volume Roads,” *Transportation Research Record 1652*, Transportation Research Board of the National Academies, 1999, pp. 113–120.



Shah, B.H., *Field Manual of Slope Stabilization*, United Nations Development Program, Pakistan, Sep. 2008 [Online]. Available: <http://www.preventionweb.net/english/professional/publications/v.php?id=13232>.

### Reinforced Soil Slopes

Reinforced soil slopes (RSS) can generally be steeper than conventional unreinforced slopes because geosynthetics (geogrids and geotextiles are both common) provide tensile reinforcement that allows slopes to be stable at steeper inclinations. The design methods for RSSs are conservative, so they are more stable than flatter slopes designed to the same safety factor (Elias et al. 2001). RSSs offer several advantages over MSE walls: backfill soil requirements are usually less restrictive, the structure is more tolerant of differential settlement, no facing element is required so they are typically less costly, and erosion protection vegetation can be incorporated into the face of the slope.

### Useful Points

- When using geosynthetics for reinforced soil slopes you need to match the type with the site-specific parameters (K. Mohamed, personal communication, April 26, 2011).

### Additional Resources for Reinforced Soil Slopes

Berg, R.R., B.R. Christopher, and N.C. Samtani, *Design of Mechanically Stabilized Earth Walls and Reinforced Soil Slopes*, Volume II, Report FHWA-NHI-10-025, Federal Highway Administration, Washington, D.C., 2009.

Berg, R., B. Christopher, and N. Samtani, *FHWA Geotechnical Engineering Circular No. 11: Design and Construction of Mechanically Stabilized Earth Walls and Reinforced Soil Slopes*, Volumes I and II, Reports FHWA-NHI-10-024 and FHWA-NHI-10-025, Federal Highway Administration, Washington, D.C., 2010.

Elias, V., B. Christopher, and R. Berg, *Mechanically Stabilized Earth Walls and Reinforced Soil Slopes Design and Construction Guidelines*, Report FHWA-NHI-00-043, Federal Highway Administration, Washington, D.C., 2001.

### Deep Patch Embankment Repair

The deep patch embankment repair is similar to a reinforced soil slope, except the repair is limited to the top of the fill slope instead of reinforcing the entire slope. It is commonly used on paved forest roads with recurring cracks and settlement in the outer portion of road. A deep patch repair involves excavating 3–8 ft (1–2.5 m) deep and reconstructing with compacted, granular soil and geogrids. Drainage is usually incorporated in the repair. Vertical spacing for the geogrid is 1 ft (30 cm), so a 6-ft-deep (2 m) repair would need six layers of geogrid. The depth, width, and length of the deep patch depend on the location of the cracks. For cracks near the outer edge of the road, a 3-ft-deep (1 m) repair is usually fine. For cracks near the centerline, especially with greater settlement (vertical displacement), a deeper repair is needed. The length of the repair should extend at least 5 ft (1.5 m) beyond the ends of the crack. Deep patches have been as short as 20 ft (6 m) and as long as 800 ft (250 m), although repairs 50–150 ft (15–45 m) long are more common. The width of the deep patch needs to extend beyond the crack so the repair is “anchored” into the stable portion of the slope. A good rule of thumb is to extend the patch 5 ft (1.5 m) behind the crack, although an analysis of pullout failure could be performed. Figure 38 shows photos of a deep patch in Gifford Pinchot National Forest in Washington during and after construction.

### Additional Resources for Deep Patch Embankment Repair

Cuelho, E.V., S. Perkins, and M.R. Akin, *Evaluation and Revision of Deep Patch Design Method*, Western Federal Lands Highway Division Report FHWA-WFL, Vancouver, Wash., 2011.



FIGURE 37 Early work by a contractor creating a geotextile wall in Alaska, and geotextile wall on fill slope of road in Klamath National Forest in California (Courtesy: J. Currey and G. Keller).

Wilson-Musser, S. and C. Denning, *Deep Patch Road Embankment Repair Application Guide*, USDA Forest Service, Washington, D.C., Oct. 2005 [Online]. Available: <http://www.fs.fed.us/t-d/pubs/pdf/05771204.pdf>.

### Tire Walls

Tire walls have been used as retaining structures, for erosion control, and to stabilize slopes (Steward 1992; Retterer 2000) (Figure 39). The tires can be used as facing or to reinforce backfill soil. Tire reinforced walls can be made from whole tires or bales of compressed tires (Retterer 2000). Tire walls can be constructed up to 10 ft in height. There are many ways to construct tire walls using varying soil and rock fill types and geosynthetics (Garga and O'Shaughnessy 2000a; Retterer 2000). To ensure tire wall strength and stability, connect the tires together appropriately (Garga and O'Shaughnessy 2000b).

Significant settlement of tire walls has been observed in field applications (Steward 1992). Some users consider tire walls to be visually unappealing. Vegetation, geotextile, shotcrete, concrete blocks, and the like can be used to cover the tire wall surface. Tire walls can be less costly than other retaining wall structures, but cost savings will vary depending on location and availability of materials. In general, tire walls can be constructed without skilled labor or special equipment (Retterer 2000).

### Additional Resources for Tire Walls

Garga, V.K. and V. O'Shaughnessy, "Tire-reinforced Earthfill. Part 1: Construction of a Test Fill, Performance, and Retaining Wall Design," *Canadian Geotechnical Journal*, Vol. 37, No. 1, 2000a, pp. 75–79.

Garga, V.K. and V. O'Shaughnessy, "Tire-reinforced Earthfill. Part 2: Pull-out Behavior and Reinforced Slope Design," *Canadian Geotechnical Journal*, Vol. 37, No. 1, 2000b, pp. 97–116.



Garga, V.K. and V. O'Shaughnessy, "Tire-reinforced Earthfill. Part 3: Environmental Assessment," *Canadian Geotechnical Journal*, Vol. 37, No. 1, 2000c, pp. 117–131.

Keller, G. and O. Cummins, "Tire Retaining Structures," *Engineering Field Notes*, Vol. 22, Mar./Apr., pp. 15–24, Forest Service, U.S. Department of Agriculture, Washington, D.C., 1990.

Setterer, T.A., "Gravity and Mechanically Stabilized Earth Walls Using Whole Scrap Tires," Master's thesis, Texas Tech University, Dallas, May 2000.

Steward, J.E., "History of Reinforced Walls in the USDA Forest Service Engineering Field Notes," *Engineering Technical Information System*, Vol. 24, Washington, D.C., Sep.–Oct. 1992.

### IN-SITU SOIL REINFORCEMENT

In-situ soil reinforcement involves repairing instabilities with minimal to no excavation by inserting reinforcing elements into the soil. Although fibers can be used as soil reinforcement (Park and Tan 2005), they are currently considered too expensive unless more low-cost fibers (e.g., recycled fibers) of high quality become available for slope stabilization applications. Similarly, the use of lime piles ("holes in the ground filled with lime") has been reported to be successful for "in situ treatment of failing clay slopes" (Rogers and Glendinning 1996) but not widely implemented for roadside slope stabilization, likely for cost reasons. Three cost-effective techniques were identified: launched soil nails, pin piles, and plate piles.

### Launched Soil Nails

Shallow instabilities can be repaired by launching an array of soil nails (also referred to as ballistic soil nailing) through



FIGURE 38 Deep patch during and after construction in Gifford Pinchot National Forest in Washington (Courtesy: B. Collins).



the ground surface deep enough to penetrate into a stable region. The technique was developed in the United Kingdom to avoid the need to excavate and construct a working platform from which traditional soil nails could be drilled and grouted in place. As illustrated in Figure 40, an excavator with a hydraulic boom is used to install soil nails between 5 and 35 ft (1.5 and 10 m) above and below its position on the road. This technique can be used for instabilities as deep as 15 ft (4.5 m) from the surface, in which case 20-ft-long (6 m) nails with a diameter of 1.5 in. (3.8 cm) would be used. For shallower instabilities, shorter nails are used and/or the portion of the nail protruding from the ground is cut off at the ground surface (USDA Forest Service 1994). Originally solid nails were used, but now hollow galvanized steel or fiberglass tubes are much more common (Barrett and Devin 2011). This technique can be used in sands, gravels, silts, clays, and soils with only a few cobbles and boulders. Too many cobbles or boulders would reduce the penetration depth of the nails. Design charts and design examples are available in a USDA Forest Service application guide (1994).

#### Additional Resources for Launched Soil Nails

*Application Guide for Launched Soil Nails*, USDA Forest Service. Report EM 7170-12A, Washington, D.C., 1994 [Online]. Available: [www.fs.fed.us/eng/pubs/pdf/em7170\\_12a.pdf](http://www.fs.fed.us/eng/pubs/pdf/em7170_12a.pdf).



FIGURE 39 Tire wall and construction (Courtesy: G. Keller).

Barrett, C.E. and S.C. Devin, “Shallow Landslide Repair Analysis Using Ballistic Soil Nails: Translating Simple Sliding Wedge Analysis into PC-Based Limit Equilibrium Models.” In *The Proceedings Geo-Frontiers 2011 Conference*, 2011.

Steward, J.E. and J.M. Ribera, “Launched Soil Nails: New Method for Rapid Low-impact Slope Repairs,” In *Proceeding of the Sixth International Conference on Low-Volume Roads*, Minneapolis, Minn., June 25–29, 1995.

#### Pin Piles (Micropiles)

Pin piles (also known as micropiles) are more commonly used for foundations than slope stabilization (Tarquinio and Pearlman 1999; Pearlman 2001). In 2000, when FHWA published design and construction guidelines for micropiles, the chapter devoted to applications for slope stabilization was left out because of a lack of consensus on design procedures. Even in 2008, use of the technique was noted to be limited (Loehr and Brown 2008). Most references to pin piles or micropiles for slope stabilization are for repairs to deep-seated failures and involve driving (or drilling and casting) long piles at various angles to form “a monolithic block of reinforced soil” (Holtz and Schuster 1996). However, anecdotal evidence of shallow repair failures 5–10 ft deep (1.5 to 3 m) using recycled railroad rails was found during the interviews, although performance and design information was not identified. When asked to provide an example of an underutilized tool, technique, or method (P. Bolander, personal communication, May 2, 2011) replied,

Possibly the use of pin piles to stabilize shallow fill slope failures, some forests in Idaho and Montana have been using railroad rails (steel, long rectangular cross section) as pin piles and have had some success. There are a couple (of) techniques. In the east coast they’ve taken these piles (steel or wood) and driven them in the top of the fill slope to reduce the fill slope settlement—intended to be a shallow repair (maybe anywhere from 5 to 10 ft deep).



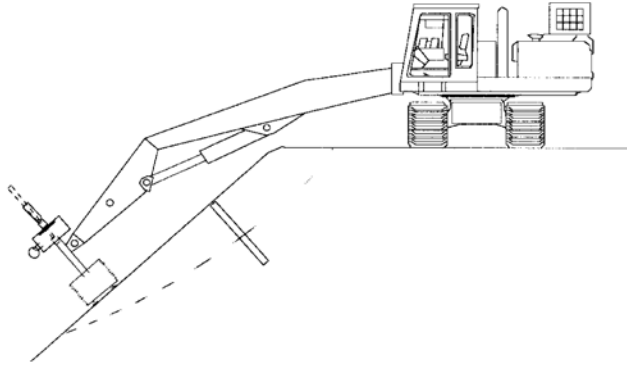

FIGURE 40 A soil nail launcher mounted on an excavator installing nails on an unstable fill slope below a road (USDA Forest Service 1994).

**Plate Piles**

Plate piles are a relatively new slope stabilization technology; the method and device were patented in 2006. As illustrated in Figure 41, an array of plate piles is driven into the soil to prevent shallow slope creep or landslides. A typical galvanized steel plate pile consists of a 2.5-in. (6 cm) L-shaped stem that is 6 ft (1.8 m) long with a 2-ft-by-1-ft (30 by 60 cm) rectangular plate attached near the top. Typical spacing is 4 ft (1.2 m) between piles within a row and 10 ft (3 m) between rows (Figure 41). Other sizes are available depending on site requirements. Successful full-scale field tests and demonstration projects have been reported (McCormick and Short 2006; Short and Collins

2006; Y. Prashar, personal communication). Ideally, the plate piles would be driven through shallow, unstable fill 2–3 ft thick (0.6–1 m) and into a more competent stratum (e.g., claystone, weak sandstone).

**Additional Resources for Plate Piles**

McCormick, W., “Platepiles: Caltrans Experiments with the Next Generation Slope Repair Alternative,” *AEG News*, Vol. 54, No. 1, Mar. 2011.

McCormick, W. and R. Short, “Cost-Effective Stabilization of Clay Slopes and Failures Using Plate Piles,” In *Proceedings of the 10th IAEG International Congress*, Nottingham, United Kingdom, Sep. 6–10, 2006.

Platepile Slope Stabilization Design Guidelines, 2nd ed., 2011. Slope Reinforcement Technology, LLC, Danille, Calif., 2011.

Short, R.D. and Y. Prashar, “Modeling a Full Scale Slide Test,” In *Proceedings of Geo-Frontiers 2011 Conference*, Dallas, Tex., Mar. 13–16, 2011.

Titi, H. and S. Helwany, *Investigation of Vertical Members to Resist Surficial Slope Instabilities*, SPR# 0092-05-09, Wisconsin Highway Research Program, Madison, 2007 [Online]. Available: <http://minds.wisconsin.edu/handle/1793/53953>.



FIGURE 41 Six-foot plate piles (left) and plate pile installation (right) using an excavator with a hydraulic hammer (Courtesy: Y. Prashar).

## CHAPTER SIX

**EARTHWORK TECHNIQUES**

This section summarizes literature and interview results on earthwork techniques. Earthwork techniques involve the physical movement of soil, rock, and/or vegetation for the purpose of erosion control and slope stabilization. As part of construction site planning and management, earthwork techniques can be employed to reshape the ground surface to planned grades and to “control surface runoff, soil erosion, and sedimentation during and after construction” (EPA 2008). For instance, land grading can be used to treat sites with uneven or steep topography or easily erodible soils so as to stabilize slopes, whereas gradient terraces can be used to reduce sediment-laden runoff by “slowing, collecting and redistributing surface runoff to stable outlets” (EPA 2008).

**IMPLEMENTING EARTHWORK TECHNIQUES**

Similar to other slope stabilization techniques, the implementation of earthwork techniques can benefit greatly from good planning that tailors the solution(s) to specific site challenges and constraints. The planning could consider whether a specific tool is suitable for the site (e.g., “gradient terraces are inappropriate for use on sandy or shallow soils, or on steep slopes”), the proper selection of site areas to be graded, the proper spacing and grading of slopes or terraces, the drainage patterns, acceptable outlets of redirected runoff, the timing of earthwork, the handling of excess or borrowed materials, and maintenance considerations (e.g., inspection after heavy rainfalls) (EPA 2008). For instance, in the early stages of design to minimize the risk of plane failure conduct engineering geological mapping when man-made cut slopes are to be constructed (Yue and Lee 2002). Existing drainage patterns are to be maintained wherever possible and measures are to be taken to minimize disturbed areas and exposed soils and to minimize possible erosion, sedimentation, and dust from exposed soils (EPA 2008).

**Useful Points**

- Avoid burying stumps, logs, slash, or organic debris in the fill material or in the road prism (Keller and Sherar 2003).

**Additional Resources for Earthwork Techniques**

Boaze, P. and B. Wiggins, “Building a Major Highway in Mountainous East Tennessee: Environmental Impacts,” *Land and Water*, Vol. 44, No. 4, 2000, pp. 20–23.

EPA, *Guidance Specifying Management Measures for Sources of Nonpoint Pollution in Coastal Waters*, EPA 840-B-92-002, Office of Water, EPA, Washington, D.C., 1993.

EPA, *Development Document for Final Action for Effluent Guidelines and Standards for the Construction and Development Category*, EPA-821-B-04-001, EPA, Washington, D.C., 2004.

EPA, *National Pollutant Discharge Elimination System: National Menu of Stormwater Best Management Practices*, Stormwater Best Management Practices, EPA, Washington, D.C., 2008 [Online]. Available: <http://cfpubl.epa.gov/npdes/stormwater/menuofbmps/index.cfm>.

EPA, *Stormwater Management for Industrial Activities: Developing Pollution Prevention Plans and Best Management Practices*, Office of Water, EPA, Washington, D.C., 1992.

Keller, G. and J. Sherar, *Low-Volume Roads Engineering—Best Management Practices Field Guide*, USDA Forest Service, Office of International Programs, and U.S. Agency for International Development, Washington, D.C., 2003 [Online]. Available: <http://www.fs.fed.us/global/topic/welcome.htm#12>.

Long, M.T., “Horizontal Drains, Application and Design,” Section 6D, In *The Slope Stability Reference Guide for National Forests in the United States*, Engineering Staff, Forest Service, USDA, Washington D.C., Dec. 1993 [Online]. Available: [http://www.fs.fed.us/rm/pubs\\_other/wo\\_em7170\\_13/wo\\_em7170\\_13\\_vol3.pdf](http://www.fs.fed.us/rm/pubs_other/wo_em7170_13/wo_em7170_13_vol3.pdf).

State of Delaware, *Delaware Erosion and Sediment Control Handbook for Development*, Division of Water Conservation, Department of Natural Resources and Environmental Control, Dover, 1989.

State of North Carolina, *Erosion and Sediment Control Planning and Design Manual*, North Carolina Sedimentation Control Commission and North Carolina Department of Natural Resources and Community Development, Raleigh, 1988.

**BENCHED SLOPES**

Many types of slope modifications include terraces, benches, steps, and serrations that are used to minimize erosion and con-





FIGURE 42 Constructed terraces on an exposed slope, taken after construction (left); Taken 6 months later after a heavy monsoon season (right), Jhelum Valley Road, Pakistan. (Courtesy: A. Faiz).

runoff (TIRRS 2001) (Figures 42 and 43). Slope shaping can also provide sites for vegetation to establish. Benches, terraces, steps, or serrations are mainly distinguished by size (TIRRS 2001). Slope shaping is well suited for large cut-and-fill slopes. The size of the bench to be installed is determined by the length and degree of the slope (Table 5). For example, long or steep slopes may require many short benches, while less steep slopes may be stabilized with steps or serrations (TIRRS 2001). When creating these feature on a slope, it is important not to leave the surface too smooth but to allow for microtopography—small uneven bumps and ridges that will collect moisture and seeds and improve chances for successful vegetation (Goldman et al. 1986, TIRRS 2001). Serrated slopes generally do not work well in erodible soils and result in further erosion of serrations. Large benches or terraces are generally more effective in erodible soils (G. Keller, personal communication, Nov. 22, 2011).

Two main advantages of benched cut slopes, from a stability point of view, is their ability to slow down the rate of surface runoff, and the fact that shallow failures are usually limited to one bench at a time (Hearn and Weeks 1997). The steps on a benched cut slope should slope into the hillside and have a drainage system installed. Vegetation is more difficult to establish on the steeper riser slopes than on a uniform slope profile. Benches provide an area for vegetation to grow, catch falling material, break up the areas of drainage, and the like (Hearn and Weekes 1997).

Maintenance of benches includes periodic inspection for damage from runoff (TIRRS 2001). If not repaired, rills and gullies may develop. Accumulated sediment may also need to be removed to prevent blockage of drains. Maintenance activities have potential for increasing erosion; therefore, limit site disturbances as much as possible.

Building terraces does not work well on decomposed granitic soils or in areas with high groundwater tables (TIRRS 2001).



FIGURE 43 Constructed terraces on exposed slopes, Asmara-Assab Road, Eritrea (Courtesy: A. Faiz).

TABLE 5  
EXAMPLES OF SLOPE MODIFICATION TECHNIQUES AND THE GENERAL PARAMETERS USED TO CREATE THEM

Slope Modification Techniques	Design Parameters
Benches or Terraces	4 to 10 ft (1.2 to 3 m) wide horizontally, level or slightly sloping toward the slope (reverse sloping)
Steps	1 to 4 ft (0.3 to 1.2 m) wide, usually horizontal
Serrations	~ 10 in. (25 cm) wide, cut by a serrated wing blade

Source: TIRRS (2001).

**Additional Resources for Benched Slopes**

Abramson, L.W., T.S. Lee, S. Sharma, and G.M. Boyce, *Slope Stability and Stabilization Methods*, John Wiley & Sons, New York, N.Y., 2002.



Goldman, S., K. Jackson, and T.A. Bursztynsky, *Erosion and Sediment Control Handbook*, McGraw Hill, New York, N.Y., 1986.

Hearn, G.J. and R.W. Weeks, *Principles of Low Cost Road Engineering in Mountainous Regions*, with special reference to Nepal, Himalaya, C.J. Lawrence, Ed., Transportation Research Library Overseas Road Note 16, Berkshire, United Kingdom, 1997.

Tahoe Interagency Roadway Runoff Subcommittee (TIRRS), *Planning Guidance for Implementing Permanent Storm Water Best Management Practices in the Lake Tahoe Basin*, Chapter 6, "Slope Stabilization Techniques," 2001.

## SOIL ROUGHENING

Soil roughening is a temporary erosion control measure that is often performed in conjunction with grading of slopes (EPA 2008). Soil roughening involves increasing the relief of a bare soil surface with horizontal grooves by either running a piece of equipment parallel to the contour of the slope or using equipment to track the surface, such as a sheep's foot attachment. As a general practice, slopes are not finely graded, but instead left in a roughened condition (Figure 44). Avoid compacting the soil with heavy equipment, specifically on clay-rich soils.



FIGURE 44 Roughened soil and trackwalking with heavy equipment (Courtesy: G. Keller).

Soil roughening reduces runoff velocity, increases infiltration rates, reduces erosion, traps sediment, and prepares soil for seeding and planting by giving seeds an opportunity to take hold and grow. Soil roughening is inexpensive, but heavy equipment is needed.

Soil roughening can be used on all graded slopes; specifically, slopes greater than 3:1, excavated soils, and highly erodible soils (EPA 2008). Soil roughening could occur as soon as vegetation has been removed, or as soon as grading

work is completed. Seeding, planting, or mulching can then be used to further stabilize the slope.

Soil roughening does not work well on rocky slopes and is only effective under moderate to light precipitation events. If heavy precipitation occurs, retracking may be needed. Roughened slopes should be monitored for rills and, if found, the slope section should be regraded and reseeded.

## Additional Resources for Soil Roughening

EPA, *Guidance Specifying Management Measures for Sources of Nonpoint Pollution in Coastal Waters*, EPA 840-B-92-002, Office of Water, U.S. Environmental Protection Agency, Office of Water, Washington, D.C., 1993.

EPA, *National Pollutant Discharge Elimination System: National Menu of Stormwater Best Management Practices*, EPA, Washington, D.C., 2008 [Online]. Available: <http://cfpub1.epa.gov/npdes/stormwater/menuofbmps/index.cfm>.

EPA, *Stormwater Management for Industrial Activities: Developing Pollution Prevention Plans and Best Management Practices*, Office of Water, EPA, Washington, D.C., 1992.

Goldman, S., K. Jackson, and T.A. Bursztynsky, *Erosion and Sediment Control Handbook*, McGraw Hill, New York, N.Y., 1986.

Smolen, M.D., D.W. Miller, L.C. Wyatt, J. Lichthardt, and A.L. Lanier, *Erosion and Sediment Control Planning and Design Manual*, North Carolina Sedimentation Control Commission; North Carolina Department of Environment, Health, and Natural Resources; and Division of Land Resources, Land Quality Section, Raleigh, 1988.

## EXTREME ROUGHENING

Extreme soil roughening is similar to soil roughening, except that it creates basins instead of microtopography. A backhoe or trackhoe shovel is used to create basins for extreme surface roughening. The trackhoe shovel is used to dig, poke, or push basins with a minimum depth of 18 in. (0.5 m). These basins should be 1.5–2 ft (0.5 m) deep and the width of the bucket, up to 4 ft (1.2 m) wide. The most common construction method is to dig a bucket load of soil and then drop it 2–3 ft (0.6–1 m) above the excavated soil surface. Repeat this process in a random and overlapping pattern, making it impossible for water to flow down-slope. Finished roughened soils should be difficult to walk over. On poor, rocky sites, basins can fill with soil relatively quickly; for this reason, the basins are to be made as large as possible. Conversely, on sites with adhesive soils, the basins should not be too large because they do not fill in with sediment over time. Surface erosion control measures

should be used. For example, straw can be spread during roughening and anchored to the soil surface by jabbing the materials into the soil surface or tacking them with hydro-mulch slurry.

Consider broadcast seeding on extreme roughened slopes. In areas with extremely dry and loose soil, it may be advantageous to wait until the soil has settled before starting the seeding process. One method is to broadcast half the seed immediately and half after the soil settles.

Problems may occur if—

- Basins are made when the soil is wet, causing hard, compacted soils to form in the depressions when dry.
- There is too much space between basins. Basins need to be overlapping.
- Basins are not large enough, making them susceptible to filling in with sediment prior to vegetation establishment.

Soil roughening is a temporary erosion control measure.

#### Additional Resources

Wright, A., Ed., *The Practical Guide to Reclamation in Utah*, Utah Division of Oil, Gas and Mining, Salt Lake City [Online]. Available: [https://fs.ogm.utah.gov/PUB/MINES/Coal\\_Related/RecMan/Reclamation\\_Manual.pdf](https://fs.ogm.utah.gov/PUB/MINES/Coal_Related/RecMan/Reclamation_Manual.pdf).

#### Ripping of Soil Surface

Ripping breaks up compacted layers of soil. Ripping is used as a soil-roughening technique in areas too large to economically roughen with a backhoe. Seed can be simultaneously spread with the ripping operation if a broadcast seeder is attached to the ripping equipment. Soil amendments or surface mulch are to be incorporated into the soil during the ripping operation or anchored with non-surface-disturbing methods such as tackifier or netting. Rip soils when they are dry to permit shattering beneath the surface.

Ripping guidelines are as follows:

- Rip to a depth of 2–3 ft (0.6–1 m) and at similar intervals.
- Rip on contour to the slope.
- Rip 10–20 ft (3–6 m) and then start again; this will reduce long water pathways.

#### Additional Resources for Ripping of Soil Surface

Wright, A., Ed., *The Practical Guide to Reclamation in Utah*, Utah Division of Oil, Gas and Mining, Salt Lake City [Online]. Available: [https://fs.ogm.utah.gov/PUB/MINES/Coal\\_Related/RecMan/Reclamation\\_Manual.pdf](https://fs.ogm.utah.gov/PUB/MINES/Coal_Related/RecMan/Reclamation_Manual.pdf).

#### FLATTENING SLOPES

Flattening oversteep slopes or slope reprofiling is a technique used to trim slopes back to a gentler slope angle (Hearn and Weekes 1997). To reprofile the slope, material is unloaded from the head or top of the slope, and/or material is placed at the base of the slope (also called toe weighting). Slope reprofiling generally increases slope stability, but is not feasible to do over large areas. Other disadvantages of flattening slopes are that acquiring additional right-of-way may be necessary, there may be a need to dispose of excess soil (often more is removed than replaced), and it can be difficult to “[find] a practical place to start the excavation” (Abramson et al. 1996). Nevertheless, slope reprofiling is one of the most widely applied and economical methods for improving slope stability (Lee et al. 2002).

#### Additional Resources for Flattening Slopes

Abramson, L.W., T.S. Lee, S. Sharma, and G.M. Boyce, *Slope Stability and Stabilization Methods*, John Wiley & Sons, New York, N.Y., 2002.

Hearn, G.J. and R.W. Weeks, *Principles of Low Cost Road Engineering in Mountainous Regions*, with special reference to Nepal, Himalaya, C.J. Lawrence, Ed., Transportation Research Library Overseas Road Note 16, Berkshire, United Kingdom, 1997.

#### LANDFORMING, GEOMORPHIC MODIFICATION

Landforming, or landform grading, aims to preserve the underlying landform through replication of geomorphology and associated vegetation, and to recreate or mimic stable natural slopes using a wide variety of slope elements and forms (Schor and Gray 2007) (Figure 45). This method differs greatly from the traditional methods of slope grading used in housing developments where linear flat pads and slopes are created. Although landform grading by itself will not prevent all erosion from occurring, the technique creates slope shapes that are less likely to suffer erosion and are more stable overall.

“Landform grading provides a cost-effective, attractive, and environmentally compatible way to construct slopes and landforms that are superior in the long run in terms of resistance to surficial erosion and mass wasting” (Schor and Gray 2007).

The traditional, “engineered” approach to slope design is characterized by linear, horizontal alignments; planar surfaces of a uniform slope ratio with a sheet flow runoff pattern and uniform plantings; and often an abrupt transition between man-made and natural slopes. The shape of traditionally engineered slopes and other man-made creations

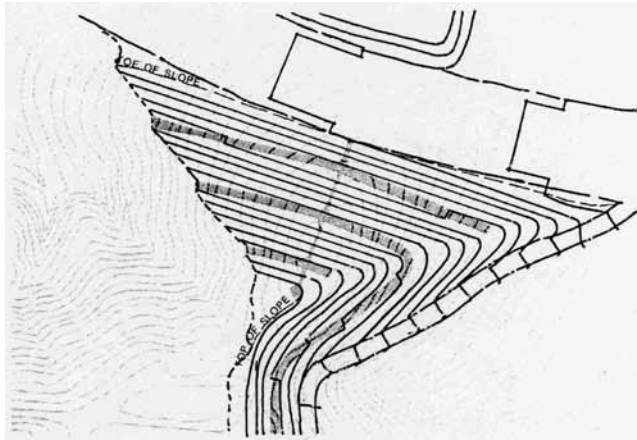

**TRADITIONAL GRADING**

*Straight angular forms and visible bench and down drains  
Slope follows roadway with a constant slope ratio*

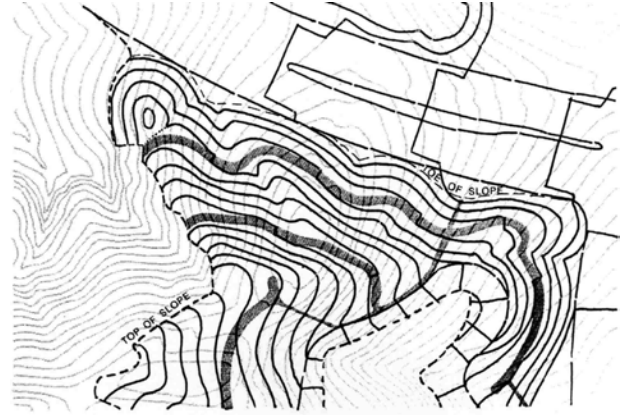

**LANDFORM GRADING**

*Area graded is increased by rounding slopes, creating swales and knolls and hiding bench and down drains  
Hillside is molded to appear natural*

FIGURE 45 Traditional grading versus landform grading (Courtesy: D. Gray).

does not typically exist in the natural topography. Landform slope design is based on the various typical natural slope elements identified and is characterized by concave and convex shapes, variable slope ratios, and diverse runoff patterns that encourage diverse revegetation patterns, as well as a more gentle transition between man-made and natural slopes (B. Schor, personal communication, June 5, 2011).

Although it is believed that landforming techniques will translate to roadway environments, landforming may not be feasible in all highway situations because of restrictions or creative limitations presented in typical linear right-of-ways adjacent to roads (B. Schor, personal communication, June 5, 2011).

Landform grading was originally developed as an alternative to traditional grading; it has been used in many other applications since its inception, such as watershed restora-

tion and mine reclamation. In a project conducted in 2004, landform grading was used in conjunction with traditional low-cost and environmentally friendly slope stabilization techniques at Nichols Arboretum in School Girl's Glen in Ann Arbor, Michigan (Gray et al. 2004). Landform grading was used to create stepped pools to handle unmitigated on-site water flow. Traditional slope stabilization techniques used were stone weirs, live staking and native plants, gabion check dams and root-wad revetment, and boulder cascades.

**Additional Resources for Landforming, Geomorphic Modification**

Schor, B. and D.H. Gray, *Landforming: An Environmental Approach to Hillside Development, Mine Reclamation and Watershed Restoration*, John Wiley & Sons, Hoboken, N.J., 2007.

CHAPTER SEVEN

## CONCLUSIONS AND KNOWLEDGE GAPS

### CONCLUSIONS

This report presented information on cost-effective and sustainable road slope stabilization techniques, with a focus on shallow or near-surface slope stabilization and related erosion control methods used on low-volume roads. To document the state of the practice, a comprehensive literature review was conducted, followed by a survey and interviews.

Information was presented on how to plan for success, including the importance of creating a work plan, project

timing, identifying necessary preliminary work, using a multidisciplinary approach, and, once completed, how to perform a site assessment and/or necessary maintenance.

The role of soil type and soil mechanics in slope stability was reviewed, including the importance of understanding what soil types are present, how they will behave under stress or saturated with water, and the mechanism by which they could fail. Understanding these concepts will aid in the selection of appropriate slope stabilization techniques and vegetation to stabilize the slope.

TABLE 6  
SUMMARY OF EROSION CONTROL TECHNIQUES

Treatment Component		Stabilization Method or Depth	Pros	Cons
Grass	Hand seeding	Shallow	No equipment required	
	Hydroseeding	Shallow	High success rate	Lack of available of equipment, limited application distance
	Sod	Shallow	High success rate	
	Slips	Shallow	Can be used to create drainage channels	Hand planting takes time
Mulching	Wood, leaf litter, straw, bark, stone	Surface	Keeps soil moist and cool, protects surface from erosion	If mulching with wood chips, nutrients may be removed from soil
Blankets and Mats	Jute, geosynthetics, rock	Surface	Keep soil moist and cool, protect surface from erosion. Aid in revegetation of steep slopes and where revegetation may be difficult	Nonbiodegradable products should be cleaned from the site
Check Dams	Inert (stone, wood, concrete)	Concentrate and control surface water flow	Reduce suspended solids in runoff	Maintenance may be required to clean out deposited sediment
	Live (vegetated)	Concentrate and control surface water flow	Reduce suspended solids in runoff; roots increase slope stabilization; modify shallow slope hydrology	Maintenance may be required to clean out deposited sediment
Wattles and Rolls	Inert (geosynthetic, straw, coir, pine needle)	Protect against sheet flow, reduce surface water velocity by breaking up the slope	Reduce suspended solids in runoff	Maintenance may be required to clean out deposited sediment, restake and replacement may be necessary; nonbiodegradable products need to be cleaned from the site
	Live (vegetated)	Protect against sheet flow, reduce surface water velocity by breaking up the slope	Reduce suspended solids in runoff; modify shallow slope hydrology	Maintenance may be required to clean out deposited sediment, restaking and replacement may be necessary
Straw Bale Barriers		Slow surface flow	Reduce suspended solids in runoff; can be used at base of slopes and around drains	Wet bales can be heavy and difficult to move; baling material may need to be removed from site if nonbiodegradable
Silt Fences		Reduce surface flow	Reduce suspended solids in runoff; can be used at base of slopes and around drains	Difficult to construct and maintain; need to be removed from the site

Appropriate water management may be the key to preventing slope failures. It is critical to develop a water management plan that identifies where the water is coming from, how the water interacts with the soil and topography of the site, where the water will go, and how much water is on site. When designing and building roads, using well-draining materials and incorporating surface and subsurface drainage where appropriate is critical.

Use of mulch and soil amendments (e.g., compost) can help on-site vegetation to stabilize a slope. In many cases, the soil exposed when cut-and-fill slopes are created along roadways is not suitable for plant growth. Soil amendments with fertilizer, compost, mulch, or additional topsoil may be necessary. Sustainable practices include saving and reusing topsoil and mulching with on-site materials.

Erosion control is the proactive use of products and techniques to prevent soil from eroding from slopes. Table 6 summarizes cost-effective and sustainable erosion control products and techniques. Erosion control products should be considered for use at every site on any disturbed soil surface. It is much easier to prevent erosion than to fix a slope that has eroded. Methods used to control surface erosion can be used alone or as components of a system. This is also true of the other slope stabilization techniques presented in this synthesis. Users of these techniques should pay close attention to ecological issues in order to minimize any possible disturbance to the local ecosystem.

Soil bioengineering and biotechnical slope stabilization is the use of vegetation and structural elements to stabilize slopes and can be both cost-effective and sustainable. Table 7 summarizes soil bioengineering and biotechnical slope stabilization techniques.

TABLE 7  
SUMMARY OF SOIL BIOENGINEERING AND BIOTECHNICAL STABILIZATION TECHNIQUES

Treatment Component	Stabilization Method or Depth	Pros	Cons	
Crib Walls	Inert (wood, concrete)	Shallow; used at base of slope	Reduce steepness, prevent shallow slope failures, work where space is limited	Do not work for large lateral stresses; maximum height 6–10 ft (2–3 m)
	Live (vegetated)	Shallow; used at base of slope	Modify shallow slope hydrology; reduce steepness, prevent shallow slope failures, work where space is limited; vegetation provides flexible binding	Do not work for large lateral stresses; maximum height 6–10 ft (2–3 m)
Stakes	Shallow, slump, or slips	Work well for projects with limited construction time; can be used to pin or anchor erosion control materials; modify shallow slope hydrology	Cuttings should be harvested within a day of planting	
Fascines	Shallow; protect against sheet flow, reduce surface water velocity by breaking up the slope	Modify shallow slope hydrology; reduce suspended solids in runoff; well suited for steep, rocky slopes; can be used to create drainage channels	Maintenance may include thinning vegetation	
Brush Layering and Palisades	Shallow; protect against sheet flow, reduce surface water velocity by breaking up the slope; armor the slope	Modify shallow slope hydrology; reduce suspended solids in runoff; can be used to create drainage channels	Maintenance may include thinning of vegetation	
Branch Packing	Shallow; used for small localized slumps, embankments, or holes.	Modifies shallow slope hydrology	Does not work on slumps greater than 4 ft (1.2 m) deep or 5 ft (1.5 m) wide; maintenance may include thinning of vegetation	
Rock Joint Planting	Shallow	Modifies shallow slope hydrology	Maintenance may include thinning of vegetation	
Gabion	Rock or earth filled, vegetated	Shallow; used at base of slope	Modifies shallow slope hydrology; reduces steepness, prevents shallow slope failures, works where space is limited; vegetation provides flexible binding	Maintenance may include thinning of vegetation
	Soft, vegetated	Shallow; used at base of slope	Modifies shallow slope hydrology; reduces steepness, prevents shallow slope failures, works where space is limited; vegetation provides flexible binding; can be used when rock is not available	Maintenance may include thinning of vegetation
Rock Wall	Vegetated	Shallow; used at base of slope	Modifies shallow slope hydrology; reduces steepness, prevents shallow slope failures, works where space is limited; vegetation provides flexible binding; can be built against undisturbed slopes	Maintenance may include thinning of vegetation; boulders or large rock are required



In addition to soil bioengineering, there are many other cost-effective and sustainable slope stabilization techniques that do not necessarily incorporate vegetation; these are grouped in the reinforced soil slope section. This section covers the use of retaining walls, geosynthetics, and other artificial and/or nonbiodegradable slope stabilizers. Table 8 summarizes these slope stabilization techniques and products.

Earthwork techniques involve the physical movement of soil, rock, and/or vegetation for the purpose of erosion control and slope stabilization. Grading work is done as part of the original road building project but can also be used to prepare a slope for a stabilization treatment. Table 9 summarizes different earthwork techniques.

The following are a few key findings to consider when planning a road slope stabilization project:

- Plan ahead.
- Know the site conditions—water, soil, topography.
- Consider current and future user needs of a road.
- Consider using cost-effective and sustainable treatments.

**KNOWLEDGE GAPS**

A significant body of information about erosion control and near-surface slope stabilization is available in the literature and in the experiences of practitioners. Knowledge gaps that still remain were compiled from review of the literature and the results of the interviews. Further research areas include the following points:

**Developing and Conducting Laboratory and Field Testing**

- Independent testing of the effectiveness of erosion-control products

TABLE 8  
SUMMARY OF MECHANICAL STABILIZATION TECHNIQUES

Treatment Component	Stabilization Method or Depth	Pros	Cons	
Walls	Masonry (rock, concrete)	Shallow to deep; protect against toe scour and undermining of cut slopes	Reduce steepness above wall, prevent shallow slope failures, work where space is limited; provide extra space for a road shoulder; built external to slope; easily conform to slope shape	Do not tolerate settlement or movement; require a drainage system behind the wall
	Gabion	Shallow to deep; at base of slope	Reduce steepness, prevent shallow slope failures, work where space is limited; provide extra space for a road shoulder; can accommodate slope movement; allow for water drainage	May require the use of an experienced contractor; baskets are rigid and can be restrictive in building
Mechanically Stabilized Earth and Geosynthetic Reinforced Soil	MSE walls (reinforcement: metal strips, welded wire, or geosynthetic facing; concrete panels, concrete blocks, metal sheets, gabion baskets, etc.)	Shallow to deep	Reduce steepness, prevent shallow slope failures, work where space is limited; provide extra space for a road shoulder; easily conform to slope shape; can accommodate complex geometries; simple and fast construction; somewhat tolerant of settlement	Good-quality backfill should be used
	Geotextile Walls	Shallow to deep; protect against toe scour and undermining of cut slopes	Reduce steepness, prevent shallow slope failures, work where space is limited; provide extra space for a road shoulder; built within the slope; tolerant of settlement; can incorporate vegetation	May require the use of an experienced contractor; geotextile surface must be protected from ultraviolet light
	Reinforced Soil Slopes	Shallow to deep	Can provide extra space for a road shoulder; tolerant of differential settling; less restrictive soil type criteria; can incorporate vegetation	Require extensive excavation for deeper instabilities
	Deep Patch Embankment Repair	Shallow	Less excavation than if repairing full depth of slope	Only applicable to failures in fill slope
	Tire Walls	Shallow	No skilled labor or special equipment required	Settlement occurs; visually unappealing
In Situ Reinforcement	Launched Soil Nails	Shallow	Little to no excavation required and little disturbance to existing vegetation	Need to catch problem before slope has failed
	Pin Piles (Micropiles)	Shallow or deep	Work with shallow and deep instabilities	No accepted standard design; more difficult installation than launched soil nails
	Plate Piles	Shallow	Promising new technique	New technique; more case studies need to be documented

- Independent testing of the effectiveness and appropriate applications for geogrids and geotextiles
- Development of a suite of standard test methods for erosion-control products
- Methods to determine when a slope is on the verge of failure, and preventive actions (which are more cost-effective than reactive measures)
- Cost-benefit analysis, predictive models, and performance evaluation criteria for each technique
- Definition of the life expectancy of each technique and actual capability of products
- Analysis techniques and understanding of pin piles
- Effects of overdigging
- Behavior of cut slopes in frozen soils and freeze/thaw issues on new slopes
- Evaluation of erosion prediction models

**Vegetation and Ecology**

- A complete record of root establishment timing, spatial distribution, and contribution to slope stability for different climates and soil compositions. Some of this information is available, but the record is incomplete.
- Identification of the current knowledge base of vegetation root behavior, which may be expanded with laboratory and field studies.
- Understanding of how soils develop on overdisturbed sites.

- The carbon sequestration potential of vegetative solutions and the contribution of these techniques to soil and water conservation.
- Highway slopes viewed as part of an ecosystem that may require restoration based on the need for increased safety, stability, and/or maintaining roadside ecology.
- Compatibility between mechanical and vegetative components of slope stabilization techniques.
- Implementation of site-specific warning systems for domestic and international travelers.

**Training and Resources**

- Greater dissemination of information and training.
- Development of a single source of good information—a one-stop-shop toolbox and/or a glove box field guide.
- Definitive standards or specifications for civil engineers who have little knowledge and training in soil science and plant science.
- Solution tailoring for specific sites. Too often, the chosen technique is based on a narrow field of candidates and without considering all possible alternatives.
- More widespread practice of proper soil analyses in the planning stages of projects.
- Mandates for the inclusion of erosion control and slope stabilization on all projects.
- Implementation of site-specific warning systems for domestic and international travelers.

TABLE 9  
SUMMARY OF EARTHWORK TECHNIQUES

Treatment Component	Stabilization Method or Depth	Pros	Cons
Benched Slopes	Benches, terraces, steps, serrations Surface to shallow; reduce surface water velocity by breaking up the slope	Shallow failures are limited to one bench at a time; reduce suspended solids in runoff	Do not work well on decomposed granite or slopes with high water tables; maintenance may include removal of accumulated sediment
Soil Roughening	Microtopography, ripping, extreme roughening Surface to shallow; reduces surface water velocity by breaking up the slope	Increases infiltration rates; reduces sediment loss	Temporary; requires the use of heavy equipment; does not work well on rocky slopes; regrading may be necessary if heavy precipitation occurs
Flattening Oversteepened Slopes	Shallow to deep	Increases slope stability	Additional right-of-way may be required; need to find a location for soil disposal; need to determine a practical place to start excavating
Landforming or Geomorphic Modification	Shallow to deep	Slopes less likely to erode; overall slopes are more stable; can be used over large or small areas	Requires the use of heavy equipment

## REFERENCES

- Abramson, L.W., T.S. Lee, S. Sharma, and G.M. Boyce, *Slope Stability and Stabilization Methods*, John Wiley & Sons, New York, N.Y., 2002.
- Adams, P.W. and C.W. Andrus, "Planning Secondary Roads to Reduce Erosion and Sedimentation in Humid Tropic Steeplands," In *Proceedings of Research Needs and Applications to Reduce Erosion and Sedimentation in Tropical Steeplands, Fiji Symposium*, IAHS-AISH Publ. No. 192, June 1990.
- Alberta Transportation, "Erosion and Sediment Control Methods," In *Design Guidelines for Erosion and Sediment Control for Highways*, Alberta Transportation, Edmonton, AB, Canada, 2003.
- Alshawabkeh, A.N., T.C. Sheahan, and X. Wu, "Coupling of Electrochemical and Mechanical Processes in Soils under DC Fields," *Mechanics of Materials*, Vol. 36, 2004, pp. 453–465.
- Ament, R., S. Jennings, and P. Bliker, *Steep Cut Slope Composting: Field Trials and Evaluation*, Final Report prepared for Montana Department of Transportation, Helena, FHWA/MT-10-008/8196 2011.
- American Association of State Highway and Transportation Officials (AASHTO), Washington, D.C. [Online]. Available: <http://transportation.org/>.
- Anderson, M.G., D.M. Lloyd, and M.J. Kemp, *Hydrological Design Manual for Slope Stability in the Tropics*, Transport Research Laboratory, Overseas Road Note 14, Berkshire, United Kingdom, 1997.
- Andreu, V., et al., "Ecotechnological Solutions for Unstable Slopes: Ground Bio- and Eco-Engineering Techniques and Strategies," In *Slope Stability and Erosion Control: Ecotechnological Solutions*, J.E. Norris, et al., Eds., Springer, Dordrecht, the Netherlands, 2008.
- Application Guide for Launched Soil Nails*, USDA Forest Service. Report EM 7170-12A, Washington, D.C., 1994 [Online]. Available: [www.fs.fed.us/eng/pubs/pdf/em7170\\_12a.pdf](http://www.fs.fed.us/eng/pubs/pdf/em7170_12a.pdf).
- Atkins, R.J., M.R. Leslie, D.F. Polster, M.P. Wise, and R.H. Wong, *Best Management Practices Handbook: Hillslope Restoration in British Columbia*, Resource Tenures and Engineering Branch, Victoria, BC Watershed Restoration Program, BC Ministry of Forests, 2001 [Online]. Available: <http://www.ieca.org/resources/federalstatewebsites.asp>.
- Barrett, C.E. and S.C. Devin, "Shallow Landslide Repair Analysis Using Ballistic Soil Nails: Translating Simple Sliding Wedge Analysis into PC-Based Limit Equilibrium Models." In *The Proceedings Geo-Frontiers 2011 Conference*, 2011.
- Barrett, C.E. and C.A. Lobato, "Launched Soil Nails: Application Evaluation in Shallow Landslide Mitigation," International Erosion Control Association, Denver, Colo., 2011 [Online]. Available: <http://www.ieca.org/member-sonly/cms/content/Proceedings/Object448PDFEnglish.pdf>.
- Berg, R.R., B.R. Christopher, and N.C. Samtani, *Design of Mechanically Stabilized Earth Walls and Reinforced Soil Slopes*, Volume II, Report FHWA-NHI-10-025, Federal Highway Administration, Washington, D.C., 2009.
- Berg, R., B. Christopher, and N. Samtani, *FHWA Geotechnical Engineering Circular No. 11: Design and Construction of Mechanically Stabilized Earth Walls and Reinforced Soil Slopes*, Volumes I and II, Reports FHWA-NHI-10-024 and FHWA-NHI-10-025, Federal Highway Administration, Washington, D.C., 2010.
- Boaze, P. and B. Wiggins, "Building a Major Highway in Mountainous East Tennessee: Environmental Impacts," *Land and Water*, Vol. 44, No. 4, 2000, pp. 20–23.
- Cai, F. and K. Ugai, "Reinforcing Mechanism of Anchors in Slopes: A Numerical Comparison of Results of LEM and FEM," *International Journal for Numerical and Analytical Methods in Geomechanics*, Vol. 27, 2003, pp. 549–564.
- California Department of Transportation (Caltrans), *Stormwater and Water Pollution Control*, Caltrans Division of Construction, Sacramento, 2011 [Online]. Available: <http://www.dot.ca.gov/hq/construc/stormwater/stormwater1.htm>.
- California Stormwater BMP Handbook*, California Stormwater Quality Association, Menlo Park, 2003 [Online]. Available: [www.cabmphandbooks.com/Documents/Construction/SE-5.pdf](http://www.cabmphandbooks.com/Documents/Construction/SE-5.pdf).
- Casagrande, L., "Stabilization of Soils by Means of Electro Osmosis: State of the Art," *Journal of Boston Society of Civil Engineering*, ASCE, Vol. 69, No. 2, 1983, pp. 255–302.
- CDM, Inc., *Erosion and Sediment Control Best Management Practices: Report*, Revised May 2004 [Online]. Available: <http://www.mdt.state.mt.us/research/projects/env/erosion.shtml>.
- Cedergren, H., *Seepage, Drainage, and Flow Nets*, 3rd ed., John Wiley and Sons, New York, N.Y., 1989.
- Chalaturnyk, R.J., J.D. Scott, D.H.K. Chan, and E.A. Richards, "Stresses and Deformations in a Reinforced Soil Slope," *Canadian Geotechnical Journal*, Vol. 27, No. 2, 1990, pp. 224–232.

- Chen, J., C. Deng, Y. Kong, and Z. He, "Experimental Study of Greening on Slopes of Qinghai–Tibet Highway in Permafrost Region," *Journal of Highway and Transportation Research and Development* (in Chinese), Vol. 26, No. 7, 2009, pp. 149–158.
- Chen, X.-P., Y.-L. Jiang, and Z.-Q. Song, "The Use of Hydroseeding Technology for Side Slope Revegetation on Loess Plateau," *Research of Soil and Water Conservation* (in Chinese), Vol. 14, No. 1, 2007, pp. 266–269.
- Chen, X., H. Zhang, X. Zhang, Y. Jiang, H. Li, C. Cao, and J. Wang, "Plants Screening for Roadside Slope Protection by Mixture Seeding in Yichang–Changyang Section of Shanghai–Chengdu Freeway," *Science of Soil and Water Conservation* (in Chinese), Vol. 9, No. 1, 2011, pp. 61–67.
- Clayton, C.R.I., N.E. Simons, and M.C. Matthews, *Site Investigation: A Handbook for Engineers*, Halsted Press, New York, N.Y., 1982.
- Cohn, W., "Polyacrylamide (PAM) for Erosion Control Applications," presented at the Southeastern Pennsylvania Stormwater Management Symposium, 2001.
- Collin, J.G., J.E. Loehr, and C.J. Hung, *Slope Maintenance and Slide Restoration Reference Manual* for NHI Course 132081, prepared for FHWA, Report FHWA NHI-08-098, 2008.
- Copstead, R., K. Johansen, and J. Moll, *Water/Road Interaction: Introduction to Surface Cross Drains*, Water/Road Interaction Technology Series, Res. Rep. 9877 1806—SDTDC, Sep. 1998 [Online]. Available: <http://www.stream.fs.fed.us/water-road/w-r-pdf/crossdrains.pdf>.
- Cuelho, E.V., S. Perkins, and M.R. Akin, *Evaluation and Revision of Deep Patch Design Method*, Western Federal Lands Highway Division Report FHWA-WFL, Vancouver, Wash., 2011.
- Das, B.M., *Principles of Foundation Engineering*, 6th ed., Cengage Learning, Stamford, Conn., 2007, 750 pp.
- Divakaran, R. and V.N. Sivasankara Pillai, "Flocculation of River Silt Using Chitosan," *Water Research*, Vol. 36, 2002, pp. 2414–2418.
- Dollhopf, D. et al., *Using Reinforced Native Grass Sod for Biostrips, Bioswales, and Sediment Control*, Final report, prepared for the California Department of Transportation, Sacramento, 2008 [Online]. Available: [http://www2.dot.ca.gov/hq/LandArch/research/docs/Montana\\_State\\_Native\\_Grass\\_Sod\\_For\\_Biostrips\\_Bioswales\\_Sediment\\_Control.pdf](http://www2.dot.ca.gov/hq/LandArch/research/docs/Montana_State_Native_Grass_Sod_For_Biostrips_Bioswales_Sediment_Control.pdf).
- Duncan, J.M. and S.G. Wright, *Soil Strength and Slope Stability*, John Wiley & Sons, Hoboken, N.J., 2005.
- Elias, V., B. Christopher, and R. Berg, *Mechanically Stabilized Earth Walls and Reinforced Soil Slopes Design and Construction Guidelines*, Report FHWA-NHI-00-043, Federal Highway Administration, Washington, D.C., 2001.
- Environmental Protection Agency (EPA), *Stormwater Management for Industrial Activities: Developing Pollution Prevention Plans and Best Management Practices*, Office of Water, EPA, Washington, D.C., 1992.
- EPA, *Guidance Specifying Management Measures for Sources of Nonpoint Pollution in Coastal Waters*, EPA 840-B-92-002, Office of Water, EPA, Washington, D.C., 1993.
- EPA, *Development Document for Final Action for Effluent Guidelines and Standards for the Construction and Development Category*, EPA-821-B-04-001, EPA, Washington, D.C., 2004.
- EPA, *National Pollutant Discharge Elimination System: National Menu of Stormwater Best Management Practices, Stormwater Best Management Practices*, EPA, Washington, D.C., 2008 [Online]. Available: <http://cfpub.epa.gov/npdes/stormwater/menuofbmps/index.cfm>.
- Ethiopia Roads Authority, *Design Manual for Low Volume Roads Part A, B and C*, Final Draft, Apr. 2011 [Online]. Available: <http://www.dfid.gov.uk/r4d/PDF/Outputs/AfCap/Design-Manual-for-Low-Volume-Roads-Part-A.pdf>.
- Etra, J., "Fiber Roles or Sediment Logs: The Rest of the Story," *Environmental Connection*, Vol. 5, No. 2, 2011, pp. 20–21.
- Faiz, A., "The Promise of Rural Roads: A Review of the Role of Low Volume Roads in Rural Connectivity, Poverty Reduction, Crisis Management, and Livability," Keynote Address, 10th International Low Volume Roads Conference, July 25, 2011.
- FHWA, *Best Management Practices for Erosion and Sediment Control*, FHWA-SLP-94-005, Federal Highway Administration, Sterling, Va., 1995.
- Field Manual on Slope Stabilization*, United Nations Development Program, Pakistan, 2008.
- Fookes, P.G., M. Sweeney, C.N.D. Manby, and R.P. Martin, "Geological and Geotechnical Engineering Aspects of Low-Cost Roads in Mountainous Terrain," *Engineering Geology*, Vol. 21, No. 1–2, 1985, pp. 1–152.
- Fox, P.J., T.H. Wu, and B. Trenner, *Bio-Engineering for Land Stabilization*, Final report prepared for the Ohio Department of Transportation, Columbus, 2010.
- Garga, V.K. and V. O'Shaughnessy, "Tire-reinforced Earth-fill. Part 1: Construction of a Test Fill, Performance, and Retaining Wall Design," *Canadian Geotechnical Journal*, Vol. 37, No. 1, 2000a, pp. 75–79.
- Garga, V.K. and V. O'Shaughnessy, "Tire-reinforced Earth-fill. Part 2: Pull-out Behavior and Reinforced Slope

- Design,” *Canadian Geotechnical Journal*, Vol. 37, No. 1, 2000b, pp. 97–116.
- Garga, V.K. and V. O’Shaughnessy, “Tire-reinforced Earth-fill. Part 3: Environmental Assessment,” *Canadian Geotechnical Journal*, Vol. 37, No. 1, 2000c, pp. 117–131.
- Gillies, C., *Erosion and Sediment Control Practices for Forest Roads and Stream Crossings—A Practical Operations Guide*, Advantage Vol. 9, No. 9, FP Innovations, FERIC Division, Forest Engineering Research Institute of Canada, Western Region, BC, Canada, 2007.
- Goldman, S., K. Jackson, and T.A. Bursztynsky, *Erosion and Sediment Control Handbook*, McGraw Hill, New York, N.Y., 1986.
- Grace, J. M. III, “Effectiveness of Vegetation in Erosion Control from Forest Road Sideslopes,” *Transactions of the ASABE*, Vol. 45, No. 3, 2002, pp. 681–685.
- Gray, D.H., R. Grese, and T. Orlow, “Saving School Girl’s Glen: Erosion Control and Watershed Restoration in a University Arboretum,” *Erosion Control*, Vol. 11, No. 2, 2004, pp. 34–45.
- Gray, D.H. and A.T. Leiser, *Biotechnical Slope Protection and Erosion Control*, Van Nostrand Reinhold Company, Inc., New York, N.Y., 1982.
- Gray, D.H. and R.B. Sotir, *Biotechnical and Soil Bioengineering Slope Stabilization: A Practical Guide for Erosion Control*, John Wiley & Sons, New York, N.Y., 1996.
- Gray, D.H. and R.B. Sotir, “Biotechnical Slope Stabilization of Steepened Slopes,” *Transportation Research Record 1474*, Transportation Research Board, National Research Council, Washington, D.C., 1995, pp. 23–29.
- Gray, D.H., C.A. White, and A.T. Leiser, “Combined Vegetative-Structural Slope Stabilization,” *Civil Engineering—ASCE*, Vol. 50, No. 1, 1980, pp. 82–85.
- Grimshaw, R.G. and A. Faiz, “Vetiver Grass: Application for Stabilization of Structures,” In *Proceedings of the Sixth International Conference on Low-Volume Roads*, Minneapolis, Minn., June 25–29, 1995.
- Guide to Slope Protection Works*, His Majesty’s Government of Nepal, Ganabahal, Kathmandu, 2003.
- Gyasi-Agyei, Y., F.P. de Troch, and P.A. Troch, “A Dynamic Hillslope Response Model in a Geomorphology-Based Rainfall–Runoff Model,” *Journal of Hydrology*, Vol. 178, No. 1–4, 1996, pp. 1–18.
- He, F., Y. Jiang, J. Yin, Z. Chen, X. Chen, and X. Wang, “Research on Regular of Wind Erosion on Road Slope Under Different Protection in Semi Arid Area of Northwest China” (in Chinese), In *Science of Soil and Water Conservation*, Vol. 5, No. 5, 2007 [Online]. Available: [http://www.sswcc.org/Jweb\\_stbc/EN/abstract/abstract9127.shtml](http://www.sswcc.org/Jweb_stbc/EN/abstract/abstract9127.shtml).
- Hearn, G.J. and R.W. Weeks, *Principles of Low Cost Road Engineering in Mountainous Regions*, with special reference to Nepal, Himalaya, C.J. Lawrence, Ed., Transportation Research Library Overseas Road Note 16, Berkshire, United Kingdom, 1997.
- Holtz, R.D. and W.D. Kovacs, *An Introduction to Geotechnical Engineering*, Prentice-Hall, Inc., Upper Saddle River, N.J., 1981.
- Holtz, R.D. and R.L. Schuster, “Stabilization of Soil Slopes,” In *Transportation Research Board Special Report 247: Landslides: Investigation and Mitigation*, A.K. Turner and R.L. Schuster, Eds., Transportation Research Board, National Research Council, Washington, D.C., 1996.
- Holtz, R.D., W.D. Kovacs, and T.C. Sheahan, *An Introduction to Geotechnical Engineering*, 2nd ed., Pearson Education, Inc., Upper Saddle River, N.J., 2011.
- Howell, J., *Roadside Bio-engineering: Site Handbook*, His Majesty’s Government of Nepal. Ganabahal, Kathmandu, 1999 [Online]. Available: <http://onlinepubs.trb.org/Onlinepubs/sp/Airport/RoadsideBioengineering.pdf>.
- Howell, J., *Roadside Bio-engineering: Site Handbook*, His Majesty’s Government of Nepal. Ganabahal, Kathmandu, 1999 [Online]. Available: <http://onlinepubs.trb.org/Onlinepubs/sp/Airport/RoadsideBioengineering.pdf>.
- Hunt, R.E., *Geotechnical Engineering Investigation Handbook*, CRC Press, LLC, Boca Raton, Fla., 2005.
- Hyman, W.A. and D. Vary, *Synthesis of Highway Practice 272: Best Management Practices for Environmental Issues Related to Highway and Street Maintenance*, Transportation Research Board, National Research Council, Washington, D.C., 1999.
- International Erosion Control Association (IECA), Denver, Colo. [Online]. Available: [www.ieca.org](http://www.ieca.org).
- Illinois Urban Manual (IUM), Practice Standard, Polyacrylamide (PAM) for Temporary Soil Stabilization (no.) Code 893, 2011 [Online]. Available: <http://aiswcd.org/IUM/standards/urbst893.html>.
- Jewell, R.A. and J.H. Greenwood, “Long-term Strength and Safety in Steep Soil Slopes Reinforced by Polymer Materials,” *Geotextiles and Geomembranes*, Vol. 7, No. 1–2, 1988, pp. 81–118.
- Jiang, Y. et al., “Applications of Bioengineering for Highway Development in Southwestern China, International Erosion Control Association,” *Ground and Water Bioengineering for the Asia-Pacific Region*, D.H. Baker, A.J. Watson, S. Sombatpanit, B. Northcutt, and A.R. Maglinao, Eds., Science Publishers, Inc., Enfield, N.H., 2004.
- Johnston, I. and R. Butterfield, “A Laboratory Investigation of Soil Consolidation by Electro-Osmosis,” *Australian Geomechanics Journal*, Vol. G7, No. 1, 1977, pp. 21–32.



- Kandaris, P.M., "Use of Gabions for Localized Slope Stabilization in Difficult Terrain," In *Proceedings of the 37th U.S. Symposium on Rock Mechanics*, Vail, Colo., June 7–9, 2007.
- Karpurapu, R. and R.J. Bathurst, "Behavior of Geosynthetic Reinforced Soil Retaining Walls Using the Finite Element Method," *Computers and Geotechnics*, Vol. 17, No. 3, 1995, pp. 279–299.
- Keller, G. and O. Cummins, "Tire Retaining Structures," *Engineering Field Notes*, Vol. 22, Mar./Apr., pp. 15–24, Forest Service, U.S. Department of Agriculture, Washington, D.C., 1990.
- Keller, G. and J. Sherar, *Low-Volume Roads Engineering—Best Management Practices Field Guide*, Office of International Programs and U.S. Agency for International Development, USDA Forest Service, Washington, D.C., 2003 [Online]. Available: <http://www.fs.fed.us/global/topic/welcome.htm#12>.
- Kling, P., M. Pyles, D. Hibbs, and B. Kauffman, *The Role of Vegetated Riprap in Highway Applications*, Final Report SPR 324, Federal Highway Administration, Washington, D.C. 2001.
- Lewis, L., *Soil Bioengineering: An Alternative for Roadside Management A Practical Guide*, USDA-FS, T&DP, 0077 1801-SDTDC, U.S. Department of Agriculture, Washington, D.C.,
- Lewis, L., S.L. Salisbury, and S. Hagen, *Soil Bioengineering for Upland Slope Stabilization*, Report WA-RD 491.1, Washington State Department of Transportation, Olympia, 2001.
- Loehr, J.E., J.J. Bowders, J.W. Owen, L. Sommers, and W. Liew, "Slope Stabilization with Recycled Plastic Pins," *Transportation Research Record 1714*, Transportation Research Board, National Research Council, Washington, D.C., 2000, pp. 1–8.
- Long, M.T., "Horizontal Drains: An Update on Methods and Procedures for Exploration, Design, and Construction of Drain Systems," *Transportation Research Record 1291*, Transportation Research Board, National Research Council, Washington, D.C., 1991, pp. 166–172.
- Long, M.T., "Horizontal Drains, Application and Design," Section 6D, In *The Slope Stability Reference Guide for National Forests in the United States*, Engineering Staff, Forest Service, USDA, Washington D.C., Dec. 1993 [Online]. Available: [http://www.fs.fed.us/rm/pubs\\_other/wo\\_em7170\\_13/wo\\_em7170\\_13\\_vol3.pdf](http://www.fs.fed.us/rm/pubs_other/wo_em7170_13/wo_em7170_13_vol3.pdf).
- McCormick, W. and R. Short, "Cost-Effective Stabilization of Clay Slopes and Failures Using Plate Piles," In *Proceedings of the 10th IAEG International Congress*, Nottingham, United Kingdom, Sep. 6–10, 2006.
- McCormick, W., "Platepiles: Caltrans Experiments with the Next Generation Slope Repair Alternative," *AEG News*, Vol. 54, No. 1, Mar. 2011.
- McCuen, R., P. Johnson, and R. Regan, *Highway Hydrology, Hydraulic Design Series No. 2*, 2nd Ed., FHWA-NHI-02-001, National Highway Institute, Federal Highway Administration, Arlington, Va., 2002 [Online]. Available: <http://isddc.dot.gov/OLPFiles/FHWA/013248.pdf>.
- Means, R.S., *Heavy Construction Cost Data*, 14th ed., R. S. Means Publishers, Kingston, Mass., 2000.
- Military Soils Engineering (MSE), FM 5-410, Chapter 10, "Slope Stabilization," 1997.
- Mohoney, J. et al., *Retaining Wall Design Guide*, Publication FHWA-FLP-94-006, Federal Lands Highway Technology Implementation Program, Washington, D.C., Sep. 1994.
- Moll, J., R. Copstead, and D.K. Johansen, *Traveled Way Surface Shape*, San Dimas Technology and Development Center, Forest Service, U.S. Department of Agriculture, Washington, D.C., Oct. 1997 [Online]. Available: <http://www.stream.fs.fed.us/water-road/w-r-pdf/surfaceshape.pdf>.
- Natural Resources Conservation Service (NRCS), "Soil Bioengineering for Upland Slope Protection and Erosion Reduction," Part 650, Chapter 18, *Engineering Field Handbook*, U.S. Department of Agriculture, Washington, D.C., Chapter 18, 1992 [Online]. Available: <ftp://ftp-fc.sc.egov.usda.gov/NHQ/pub/outgoing/jbernard/CED-Directives/efh/EFH-Ch18.pdf>.
- NRCS, "Temporary Erosion Control Around the Home Following a Fire: Jute Netting," *NRCS Fact Sheet*, California FS-54, 2007 [Online]. Available: <ftp://ftp-fc.sc.egov.usda.gov/CA/programs/EWP/2007/FS54.pdf>.
- NRCS, "Hydroseeding and Hydromulching Fact Sheet," Wyoming, 2011 [Online]. Available: <http://www.wy.nrcs.usda.gov/technical/ewpfactsheets/hydroseed.html>.
- Naval Facilities Engineering Command (NAVFAC), *Foundations and Earth Structures. Design Manual 7.02*, Naval Facilities Engineering Command, Alexandria, Va., 1986.
- Nichols, E., *Synthetic and Natural Cationic Polymers for Clarification of Environmental Water and the Significance of Cationicity*, White paper, Scientific Director of Water Treatment Technologies.
- Normann, J., R. Houghtalen, and W. Johnston, *Hydraulic Design of Highway Culverts*, Hydraulic Design Series (HDS) No. 5, FHWA-NHI-01-020, Federal Highway Administration and National Highway Institute, Washington, D.C., 2001 (rev. 2005) [Online]. Available: [http://www.fhwa.dot.gov/engineering/hydraulics/library\\_arc.cfm?pub\\_number=7&id=13](http://www.fhwa.dot.gov/engineering/hydraulics/library_arc.cfm?pub_number=7&id=13).

- Orr, D., *Roadway and Roadside Drainage*, CLRP Publication No. 98-5, Cornell Local Roads Program and New York LTAP Center, Ithaca, N.Y., 1998 (updated 2003) [Online]. Available: [http://www.clrp.cornell.edu/workshops/pdf/drainage\\_08\\_reprint-web.pdf](http://www.clrp.cornell.edu/workshops/pdf/drainage_08_reprint-web.pdf).
- Orts, W.J., R.E. Sojka, and G.M. Glenn, "Biopolymer Additives to Reduce Erosion-induced Soil Losses During Irrigation," *Industrial Crops and Products*, Vol. 11, No. 1, 2000, pp. 19–29.
- Paczkowska, B., "Electroosmotic Introduction of Methacrylate Polycations to Dehydrate Clayey Soil," *Canadian Geotechnical Journal*, Vol. 42, 2005, pp. 780–786.
- Park, T. and S.A. Tan, "Enhanced Performance of Reinforced Soil Walls by the Inclusion of Short Fiber," *Geotextiles and Geomembranes*, Vol. 23, No. 4, 2005, pp. 348–361.
- Pearlman, S.L., B.D. Campbell, and J.L. Withiam, "Slope Stabilization Using In-Situ Earth Reinforcements," In *Proceedings of the Conference on Stability and Performance of Slopes and Embankment II* (GSP 31), 1992, pp. 1333–1348.
- Pearlman, S.L., "Pin Piles for Structural Underpinning," presented at the Ohio River Valley Soils Seminar XXXIII, Louisville, Ky., Oct. 24, 2001.
- Platepile Slope Stabilization Design Guidelines*, 2nd ed., Slope Reinforcement Technology, LLC, Danville, Calif., 2011.
- Powell, W., G.R. Keller, and B. Brunette, "Applications for Geosynthetics on Forest Service Low-Volume Roads," *Transportation Research Record 1652*, Transportation Research Board of the National Academies, Washington, D.C., 1999, pp. 113–120.
- Ramakrishna, A.S. and D. Sapzova, *Using Bioengineering to Stabilize Landslide-Prone Hill Slides. Innovations in Development*, Mizoram Roads Project, The World Bank, India, 2011.
- Rao, K.P.C., A.L. Cogle, and K.L. Srivastava, "Conservation Effects of Porous and Vegetative Barriers," In *ICRISAT Annual Report 1991: Resource Management Program*, International Crops Research Institute for Semi-Arid Tropics, Patancheru, Andhra Pradesh, India, 1992.
- Rao, K.P.C., A.L. Cogle, and K.L. Srivastava, "Conservation Effects of Porous and Vegetative Barriers," In *ICRISAT Annual Report 1992: Resource Management Program*, International Crops Research Institute for Semi-Arid Tropics, Patancheru, Andhra Pradesh, India, 1993.
- Research and Innovative Technology Administration, "Stabilizing Marginal Soils with Fibers and Chemicals for Roadways and Airports," *UTC Spotlight*, U.S. Department of Transportation, Washington, D.C., 2011 [Online]. Available: <http://utc.dot.gov/>.
- Reubens, B., J. Poesen, F. Danjon, G. Geudens, and B. Muys, "The Role of Fine and Coarse Roots in Shallow Slope Stability and Soil Erosion Control with a Focus on Root System Architecture," *Trees*, Vol. 21, 2007, pp. 385–402.
- Rivas, T., *Erosion Control Treatment Selection Guide*, Gen. Tech Rep. 0677 1203—SDTDC, San Dimas Technology and Development Center, USDA Forest Service, San Dimas, Calif., 2006 [Online]. Available: [http://www.fs.fed.us/eng/pubs/pdf/hi\\_res/06771203hi.pdf](http://www.fs.fed.us/eng/pubs/pdf/hi_res/06771203hi.pdf).
- Rogers, C.D.F. and S. Glendinning, "The Role of Lime Migration in Lime Pile Stabilization of Slopes," *Quarterly Journal of Engineering Geology*, Vol. 29, 1996, pp. 273–284.
- Rogers, C.D.F., S. Glendinning, and C.C. Holt, "Slope Stabilization Using Lime Piles—A Case Study," In *Proceedings of the ICE—Ground Improvement*, Vol. 4, No. 4, 2000, pp. 165–176.
- Royster, D.L., *Landslide Remedial Measures*, Publication Number 1011, Tennessee Department of Transportation, Nashville, 1982.
- Sara, M.N., *Site Assessment and Remediation Handbook*, CRC Press, LLC, Boca Raton, Fla., 2003.
- Schiechtl, H.M. and R. Stern, *Ground Bioengineering Techniques for Slope Protection and Erosion Control*, David H. Baker, Ed., translated by L. Jaklitsch, Wiley–Blackwell, Oxford, U.K., 1966.
- Schiechtl, H., *Bioengineering for Land Reclamation and Conservation*, The University of Alberta Press, Edmonton, AB, Canada, 1980.
- Schor, B. and D.H. Gray, *Landforming: An Environmental Approach to Hillside Development, Mine Reclamation and Watershed Restoration*, John Wiley & Sons, Hoboken, N.J., 2007.
- Setterer, T.A., Gravity and Mechanically Stabilized Earth Walls Using Whole Scrap Tires, Master's thesis, Texas Tech University, Dallas, May 2000.
- Shah, B.H., *Field Manual of Slope Stabilization*, United Nations Development Program, Pakistan, Sep. 2008 [Online]. Available: <http://www.preventionweb.net/english/professional/publications/v.php?id=13232>.
- Short, R. and B.D. Collins, "Testing and Evaluation of Driven Plate Piles in a Full Size Test Slope: A New Method for Stabilizing Shallow Landslides," CD-ROM, 85th Annual Meeting of the Transportation Research Board, Washington, D.C., Jan. 22–26, 2006.
- Short, R.D. and Y. Prashar, "Modeling a Full Scale Slide Test," In *Proceedings of Geo-Frontiers 2011 Conference*, Dallas, Tex., Mar. 13–16, 2011.
- Shrestha, P.K. and S. Manandhar, "Water Management: A Vital Component for the Sustainability of Rural Roads in

- Nepal,” presented at Transport in Mountain, An International Workshop, Kathmandu, Nepal, Nov. 21–27, 2010.
- Simac, M.R., R.J. Bathurst, and T.W. Fennessey, “Case Study of a Hybrid Gabion Basket Geosynthetic Reinforced Soil Wall,” *Ground Improvement*, Vol. 1, 1997, pp. 9–17.
- Smolen, M.D., D.W. Miller, L.C. Wyatt, J. Lichthardt, and A.L. Lanier, *Erosion and Sediment Control Planning and Design Manual*, North Carolina Sedimentation Control Commission; North Carolina Department of Environment, Health, and Natural Resources; and Division of Land Resources, Land Quality Section, Raleigh, 1988.
- Sojka, R.E., D.L. Bjorneberg, J.A. Entry, R.D. Lentz, and W.J. Orts, “Polyacrylamide in Agriculture and Environmental Land Management,” *Advances in Agronomy*, Vol. 92, 2007, pp. 75–162.
- Sotir, R.B. and M.A. McCaffrey, “Stabilization of High Soil and Rock Cut Slope by Soil Bioengineering and Conventional Engineering,” *Transportation Research Record 1589*, Transportation Research Board, National Research Council, Washington, D.C., 1997, pp. 92–98.
- South Dakota Department of Transportation (SDDOT), “Roadside Development” *Road Design Manual*, SDDOT, Pierre, 2004 [Online]. Available: <http://www.sddot.com/pe/roaddesign/docs/rdmanual/rdmch14.pdf>.
- Sprague, J. and T. Carpenter, “Silt Fence Installation Efficacy: Definitive Research Call for Toughening Specifications and Introducing New Technology,” International Erosion Control Association, Denver, Colo., 2011 [Online]. Available: [www.ieca.org/resources/documents/Article/ArticleSFInstallationEfficacy.asp](http://www.ieca.org/resources/documents/Article/ArticleSFInstallationEfficacy.asp).
- State of Delaware, *Delaware Erosion and Sediment Control Handbook for Development*, Division of Water Conservation, Department of Natural Resources and Environmental Control, Dover, 1989.
- State of North Carolina, *Erosion and Sediment Control Planning and Design Manual*, North Carolina Sedimentation Control Commission and North Carolina Department of Natural Resources and Community Development, Raleigh, 1988.
- Steward, J.E. and J.M. Ribera, “Launched Soil Nails: New Method for Rapid Low-impact Slope Repairs,” In *Proceeding of the Sixth International Conference on Low-Volume Roads*, Minneapolis, Minn., June 25–29, 1995.
- Storm Water Services (SWS), Runoff Management, Fiber rolls/wattles (RM-10), Springfield, Mo., 2008 [Online]. Available: [www.sprfieldmo.gov/stormwater/pdfs/BMP%20PDFs/RM%20BMPs/FIBER%20ROLLS-WATTLES.pdf](http://www.sprfieldmo.gov/stormwater/pdfs/BMP%20PDFs/RM%20BMPs/FIBER%20ROLLS-WATTLES.pdf).
- Stormwater Quality Handbooks (SQH), *Construction Site Best Management Practices (BMPs) Manual*, California Department of Transportation (Caltrans), Sacramento, Nov. 2000.
- Tahoe Interagency Roadway Runoff Subcommittee (TIRRS), *Planning Guidance for Implementing Permanent Storm Water Best Management Practices in the Lake Tahoe Basin*, Chapter 6, “Slope Stabilization Techniques,” 2001.
- Taquinio, F. and S.L. Pearlman, “Pin Piles for Building Foundations,” presented at the 7th Annual Great Lakes Geotechnical and Geoenvironmental Conference, Kent, Ohio, May 10, 1999.
- Titi, H. and S. Helwany, *Investigation of Vertical Members to Resist Surficial Slope Instabilities*, SPR# 0092-05-09, Wisconsin Highway Research Program, Madison, 2007 [Online]. Available: <http://minds.wisconsin.edu/handle/1793/53953>.
- Tormo, J., E. Bochet, and P. García-Fayos, “Roadfill Revegetation in Semiarid Mediterranean Environments. Part II: Topsoiling, Species Selection, and Hydroseeding,” *Restoration Ecology*, Vol. 15, No. 1, 2007, pp. 97–102.
- Turner, K.A. and R.L. Schuster, Eds., *Special Report 247: Landslides Investigation and Mitigation*, National Academy Press, Washington, D.C., 1996.
- Steward, J.E., “History of Reinforced Walls in the USDA Forest Service Engineering Field Notes,” *Engineering Technical Information System*, Vol. 24, Washington, D.C., Sep.–Oct. 1992.
- U.S. Department of Agriculture (USDA), *Natural Resources Conservation Service, National Engineering Handbook*, Part 650, Engineering Field Handbook, Chapter 18, “Soil Bioengineering for Upland Slope Protection and Erosion Reduction,” USDA, Washington, D.C., 1992.
- Van Buskirk, C., “Adoption and Implementation of GRS Design Concepts: A Consultant’s Perspective,” GCS Wall Website, 2010 [Online]. Available: <http://gcswall.com/pdf/calvingcsgrspaper2010.pdf>.
- Wan, T. and J.K. Mitchell, “Electro-osmotic Consolidation of Soils,” *Journal of Geotechnical Engineering*, Division 102 (GT5), ASCE, 1976, pp. 473–491.
- Washington State Department of Transportation, “Soil Bioengineering,” Olympia, 2011 [Online]. Available: <http://www.wsdot.wa.gov/Design/Roadside/SoilBioengineering.htm>.
- Wilson-Musser, S. and C. Denning, *Deep Patch Road Embankment Repair Application Guide*, USDA Forest Service, Washington, D.C., Oct. 2005 [Online]. Available: <http://www.fs.fed.us/t-d/pubs/pdf/05771204.pdf>.
- World Bank, *Vetiver Grass—The Hedge Against Erosion*, 3rd ed. The World Bank, Washington, D.C., 1990.

- Wright, A., Ed., *The Practical Guide to Reclamation in Utah*, Utah Division of Oil, Gas and Mining, Salt Lake City [Online]. Available: [https://fs.ogm.utah.gov/PUB/MINES/Coal\\_Related/RecMan/Reclamation\\_Manual.pdf](https://fs.ogm.utah.gov/PUB/MINES/Coal_Related/RecMan/Reclamation_Manual.pdf).
- Xu, X., K. Zhang, Y. Kong, J. Chen, and B. Yu, "Effectiveness of Erosion Control Measures Along the Qinghai-Tibet Highway, Tibetan Plateau, China," *Transportation Research Part D 11*, 2006, pp. 302–309.
- Xu, X.-L., K.-L. Zhang, L.-F. , Luo, Y.-P., Kong, and L. Pang, "Relations Between Rain Characters and Sediment Yielding and Runoff on Embankment Slope of Qinghai-Tibet Road," *Journal of Soil and Water Conservation* (in Chinese), Vol. 9, No. 1, 2005, pp. 23–24, 74.
- Zhang, Z.-C. and X.-P. Chen, "A New Type of Masonry Retaining Wall Face-Protecting Greening Technology—Ladder Hollow Brick Greening," *Communications Standardization* (in Chinese), 2008, Vol. 7, pp. 1–4.
- Zornberg, J.G., "Discrete Framework for Limit Equilibrium Analysis of Fibre-reinforced Soil," *Géotechnique*, Vol. 52, No. 8, 2002, pp. 593–604.
- Zornberg, J.G., N. Sitar, and J.K. Mitchell, "Performance of Geosynthetic Reinforced Slopes at Failure," *Journal of Geotechnical and Geoenvironmental Engineering*, Vol. 124, No. 8, 1998, pp. 670–683.

## APPENDIX A

### Survey Questions

A survey was developed to gather additional information from practitioners, scientists, contractors, and vendors on current practices, best practices, and emerging solutions that are used regionally, nationally, or internationally. The survey was created in Survey Monkey (<http://www.surveymonkey.com/>), an Internet-based survey tool that allows survey respondents to answer questions online. The survey asked participants to provide identifying information, followed by eight questions requesting information on the respondents' direct experience with erosion control and slope stabilization techniques. The survey was distributed by e-mail to individuals identified in the literature review and by project panel members. Information gathered in the survey that was incorporated into this report includes resources, references, erosion control and slope stabilization techniques and tools, best management practices, useful points, and photographs. Survey responses aided in focusing the synthesis on the most frequently used road slope stabilization techniques that are cost-effective and sustainable.

#### Survey Questions

1. Please provide the following information:

Name \_\_\_\_\_

Company/Agency \_\_\_\_\_

Address \_\_\_\_\_

City/Town \_\_\_\_\_

State/Province \_\_\_\_\_

Zip/Postal Code \_\_\_\_\_

Country \_\_\_\_\_

E-mail address \_\_\_\_\_

Phone Number \_\_\_\_\_

2. How frequently do you use shallow or near surface road slope stabilization and/or erosion control measures in your job?

Always

Frequently

Occasionally

Never (If never, please describe your experience with road slope stabilization and erosion control below).

3. Please check the road slope stabilization and/or erosion control measures you have used.

Water management plan

Soil bioengineering

Reinforced soil slopes

Biotechnical slope stabilization

Structural stabilization

Surface and subsurface water drainage

Erosion control mats/treatments

Flattening failing/over-steep slopes

Shallow structures

Earthwork and/or terracing

Shallow anchors



- Anchored wire or mesh
- Pins and/or posts
- Buttresses or low-cost retaining structures
- Brush layering
- Live stakes
- Vegetated walls
- Vegetated reinforced soil slopes
- Geotextile (burrito) walls
- Low gabion walls
- Deep patch geosynthetic road shoulder reinforcement
- Hydro seeding
- Hand seeding
- Other (please specify):

4. Where do you use road slope stabilization measures?

- Embankments
- Road cut and fill slopes
- Culverts
- Bridges
- Other slopes
- Ditch cleaning or reshaping
- Other (please specify):

5. When considering a road slope stabilization or erosion control measure, how important is cost?

- Initial/short term—extremely important, important, somewhat important, not important at all
- Long term (including maintenance)—extremely important, important, somewhat important, not important at all
- Both short and long term considered together—extremely important, important, somewhat important, not important at all

6. When considering a road slope stabilization or erosion control measure, how do you factor in how environmentally friendly or sustainable it is in your decision-making process?

- Always
- Frequently
- Occasionally
- Never
- If considered please describe why (i.e., state mandate)

7. Can you provide examples of successful road slope stabilization measures you have used that were sustainable, environmentally friendly, and/or low cost? (If so, do you have drawings, sketches, or photos of these?)

- Yes
- No

If Yes, please provide up to three examples below.

---

---

---

8. If you answered yes to the previous question, may we contact you for additional information and a possible follow-up interview?

Yes

No

Contact information for follow-up interview (if you did not provide it initially).

---

9. Please point us to 1–2 relevant documents/publications or professionals that can benefit this project.

## APPENDIX B

### Interview Questions And Respondents

Interview questions were developed to gain information not available from the survey responses. A list was compiled of survey respondents who indicated they were willing to participate in follow-up interviews. Interviewees were asked 16 questions and instructed to provide responses based only on their direct experiences. Interview responses were recorded with a digital recorder and then transcribed or recorded by hand during the interview process. Thirty individuals were selected and asked to be interviewed based on the information they made available in the survey. A total of 25 interviews were conducted, providing an 83% interview response rate. Interviews were conducted over the phone with the exception of two e-mail responses (owing to the interviewees' location and language differences). Information gained from the interviews and incorporated into this report includes additional resources, references, erosion control and slope stabilization techniques and tools, best management practices, useful points, photographs, knowledge gaps, and research needs.

#### Interview Questions

NCHRP Synthesis *Low-Cost Solutions for Road Slope Stabilization and Erosion Control*

Please read this paragraph before you begin the interview.

Hello, my name is Laura Fay/Michelle Akin from the Western Transportation Institute at Montana State University. In the survey for the NCHRP Synthesis *Low-Cost Solutions for Road Slope Stabilization and Erosion Control*, sponsored by the National Cooperative Highway Research Program under the National Academies, you identified yourself as being willing to participate in a follow-up interview or you were identified by a survey respondent as a potential interviewee. We are seeking your participation in a follow-up interview in which we are compiling information on cost-effective (i.e., low cost), environmentally friendly, and sustainable shallow or near-surface slope stabilization and related erosion-control treatments used on low-volume roads. We are seeking information on current practices, best practices, or emerging solutions that are used regionally, nationally, or internationally.

This interview will take approximately 10–20 minutes of your time and will ask for you to comment on your direct experience on this topic. Participation is voluntary, and you can choose to not answer any question that you do not want to answer, and you can stop at anytime. May I audio record this interview? If not, I will be documenting all of your answers by hand—is that all right with you?

1. Name, title, agency, contact information.
2. Please describe your working experience with road slope stabilization.
3. What road slope stabilization technique do you most frequently use?
4. Based on your experience, what is the most cost-effective road slope stabilization technique?
5. Have you used this method? If so, do you have information (photos, data, design, cost, benefits, limitations, life expectancy, etc.) from the implementations that you could share?
6. Based on your experience what is the most sustainable/environmentally friendly road slope stabilization technique?
7. Have you used this method? If so do you have information (photos, data, design, cost, benefits, limitations, life expectancy, etc.) from the implementations that you could share?
8. Can you provide us with a description of up to three road slope stabilization projects that you have completed that were both low-cost/cost-effective and sustainable/environmentally friendly?
9. Could you tell us about some lessons learned in road slope stabilization related to the examples you have provided?
10. Are there road slope stabilization techniques/treatments you would never try or use again? Why?

11. What do you see as an underutilized tool, material, method, etc., in road slope stabilization?
12. Where do you see gaps in current state of practice of road slope stabilization, or do you see any need for additional research?
13. Could you provide a name of an individual who may be willing to be interviewed on this topic or point us to additional resources or case examples?
14. Would you like to receive an e-mail with a link to the final report when it becomes available? If so, please provide the e-mail address you would like the link to the final report to go to.
15. Comments/suggestions
16. Thank you for your time. May we thank you for your participation by listing your name in our final report?

#### **List of Interviewees**

The following individuals were interviewed:

- Vickie Bender, Alaska Road Builders
- Chris Bennett, World Bank
- Pete Bolander, USDA Forest Service
- Chenjianye, China Academy of Transportation Science
- Xueping Chen, China Academy of Transportation Science
- Paul Clark, Valley Hydromulch & Revegetation
- Jeff Currey, Alaska DOT & Public Facilities
- Asif Faiz, World Bank
- Donald Gray, University of Michigan
- Jim Haang, Franklin County, Ottawa, Kansas
- Stuart Jennings, Reclamation Research Group, LLC
- Byron Johnson, Kentucky Transportation Cabinet
- Gordon Keller, USDA Forest Service
- Kathy Kinsella, Town of Rhinebeck Highway Department
- Chris Marr, ESI Resource Services, LLC
- Khalid Mohamed, FHWA Office of Infrastructure
- David Orr, Cornell Local Roads Program
- Dave Polster, Polster Environmental Services, Ltd.
- Skip Ragsdale, Sunshine Supplies, Inc.
- Steve Romero, USDA Forest Service
- Warren Schlatter, Defiance County (Ohio) Engineer's Office
- Roger Skirrow, Alberta Ministry of Transportation
- David Steinfeld, USDA Forest Service
- Bob Vitale, Midwest Industrial Supply, Inc.
- Stan Vitton, Michigan Technological University

## APPENDIX C

### Slope Ratio Versus Percent Slope Diagram

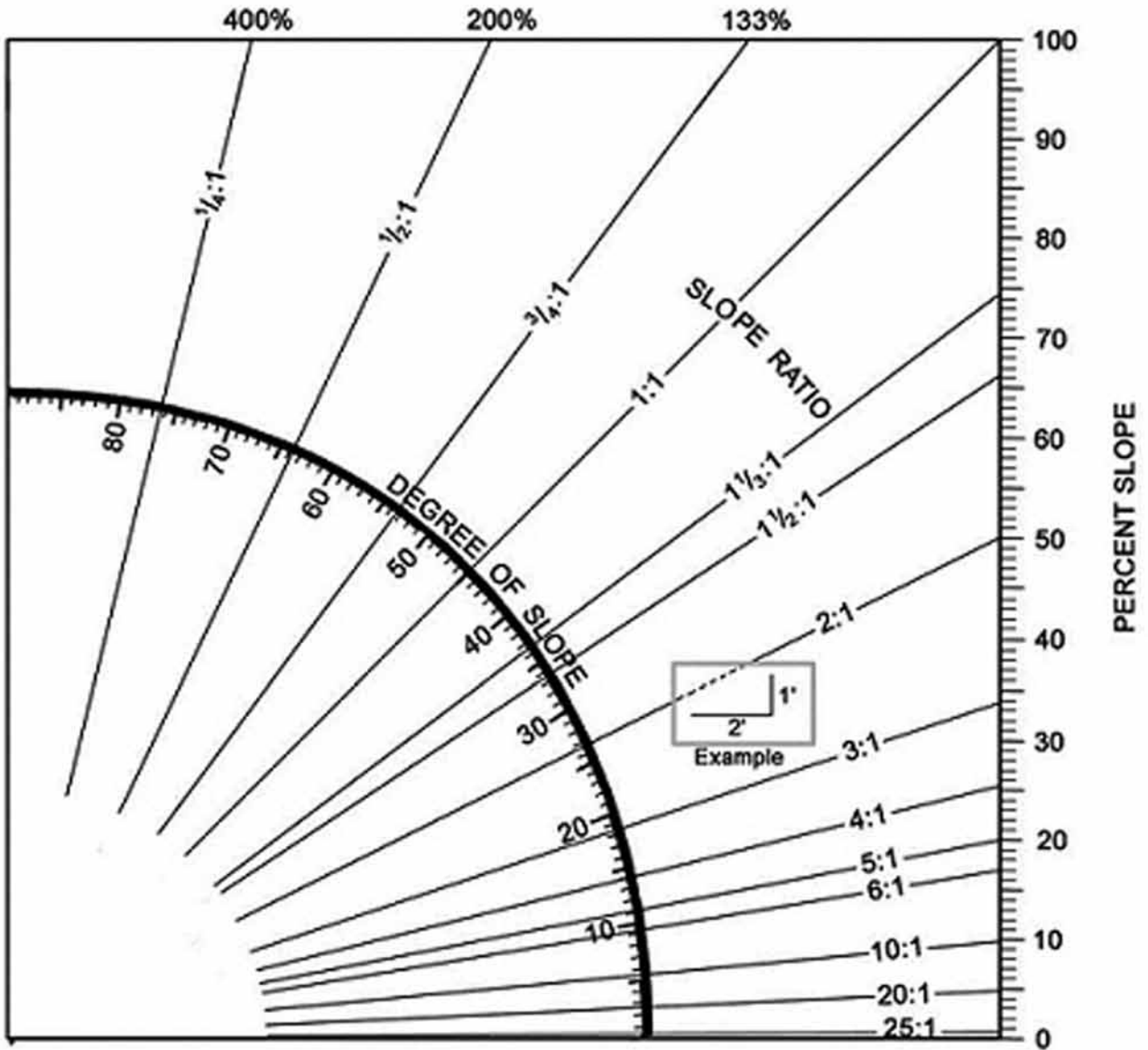

**CHECK  
DRAWING**  
11-09-07

FIGURE 46 Degree of slope and percent slope to slope ratio cheat sheet (Courtesy: G. Keller).



*Abbreviations and acronyms used without definitions in TRB publications:*

AAAE	American Association of Airport Executives
AASHO	American Association of State Highway Officials
AASHTO	American Association of State Highway and Transportation Officials
ACI-NA	Airports Council International-North America
ACRP	Airport Cooperative Research Program
ADA	Americans with Disabilities Act
APTA	American Public Transportation Association
ASCE	American Society of Civil Engineers
ASME	American Society of Mechanical Engineers
ASTM	American Society for Testing and Materials
ATA	Air Transport Association
ATA	American Trucking Associations
CTAA	Community Transportation Association of America
CTBSSP	Commercial Truck and Bus Safety Synthesis Program
DHS	Department of Homeland Security
DOE	Department of Energy
EPA	Environmental Protection Agency
FAA	Federal Aviation Administration
FHWA	Federal Highway Administration
FMCSA	Federal Motor Carrier Safety Administration
FRA	Federal Railroad Administration
FTA	Federal Transit Administration
HMCRP	Hazardous Materials Cooperative Research Program
IEEE	Institute of Electrical and Electronics Engineers
ISTEA	Intermodal Surface Transportation Efficiency Act of 1991
ITE	Institute of Transportation Engineers
NASA	National Aeronautics and Space Administration
NASAO	National Association of State Aviation Officials
NCFRP	National Cooperative Freight Research Program
NCHRP	National Cooperative Highway Research Program
NHTSA	National Highway Traffic Safety Administration
NTSB	National Transportation Safety Board
PHMSA	Pipeline and Hazardous Materials Safety Administration
RITA	Research and Innovative Technology Administration
SAE	Society of Automotive Engineers
SAFETEA-LU	Safe, Accountable, Flexible, Efficient Transportation Equity Act: A Legacy for Users (2005)
TCRP	Transit Cooperative Research Program
TEA-21	Transportation Equity Act for the 21st Century (1998)
TRB	Transportation Research Board
TSA	Transportation Security Administration
U.S.DOT	United States Department of Transportation

TRANSPORTATION RESEARCH BOARD  
500 Fifth Street, N.W.  
Washington, D.C. 20001

ADDRESS SERVICE REQUESTED

**THE NATIONAL ACADEMIES™**  
*Advisers to the Nation on Science, Engineering, and Medicine*

The nation turns to the National Academies—National Academy of Sciences, National Academy of Engineering, Institute of Medicine, and National Research Council—for independent, objective advice on issues that affect people's lives worldwide.

[www.national-academies.org](http://www.national-academies.org)

ISBN: 978-0-309-22362-1

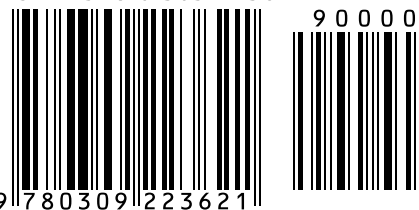

9 780309 223621