

## Accessible Pedestrian Signals: A Guide to Best Practices (Workshop Edition 2010)

### DETAILS

---

0 pages | null | PAPERBACK

ISBN 978-0-309-43028-9 | DOI 10.17226/22902

### AUTHORS

---

BUY THIS BOOK

FIND RELATED TITLES

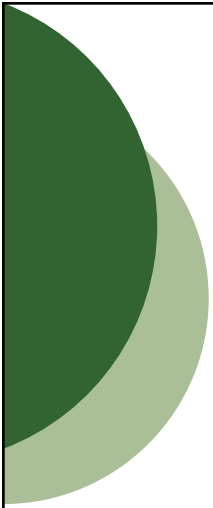
Visit the National Academies Press at [NAP.edu](http://NAP.edu) and login or register to get:

---

- Access to free PDF downloads of thousands of scientific reports
- 10% off the price of print titles
- Email or social media notifications of new titles related to your interests
- Special offers and discounts



Distribution, posting, or copying of this PDF is strictly prohibited without written permission of the National Academies Press. (Request Permission) Unless otherwise indicated, all materials in this PDF are copyrighted by the National Academy of Sciences.



---

# NCHRP

Web-Only Document 150:

## Accessible Pedestrian Signals: A Guide to Best Practices (Workshop Edition 2010)

David L. Harkey  
Daniel Carter

University of North Carolina Highway Safety Research Center  
Chapel Hill, NC

Billie L. Bentzen  
Janet M. Barlow

Accessible Design for the Blind  
Asheville, NC

Contractor's Guide for NCHRP Project 3-62A  
Submitted November 2009

**National Cooperative Highway Research Program**

TRANSPORTATION RESEARCH BOARD  
OF THE NATIONAL ACADEMIES

### **ACKNOWLEDGMENT**

This work was sponsored by the American Association of State Highway and Transportation Officials (AASHTO), in cooperation with the Federal Highway Administration, and was conducted in the National Cooperative Highway Research Program (NCHRP), which is administered by the Transportation Research Board (TRB) of the National Academies.

### **COPYRIGHT INFORMATION**

Authors herein are responsible for the authenticity of their materials and for obtaining written permissions from publishers or persons who own the copyright to any previously published or copyrighted material used herein.

Cooperative Research Programs (CRP) grants permission to reproduce material in this publication for classroom and not-for-profit purposes. Permission is given with the understanding that none of the material will be used to imply TRB, AASHTO, FAA, FHWA, FMCSA, FTA, Transit Development Corporation, or AOC endorsement of a particular product, method, or practice. It is expected that those reproducing the material in this document for educational and not-for-profit uses will give appropriate acknowledgment of the source of any reprinted or reproduced material. For other uses of the material, request permission from CRP.

### **DISCLAIMER**

The opinions and conclusions expressed or implied in this report are those of the researchers who performed the research. They are not necessarily those of the Transportation Research Board, the National Research Council, or the program sponsors.

The information contained in this document was taken directly from the submission of the author(s). This material has not been edited by TRB.

# THE NATIONAL ACADEMIES

*Advisers to the Nation on Science, Engineering, and Medicine*

The **National Academy of Sciences** is a private, nonprofit, self-perpetuating society of distinguished scholars engaged in scientific and engineering research, dedicated to the furtherance of science and technology and to their use for the general welfare. On the authority of the charter granted to it by the Congress in 1863, the Academy has a mandate that requires it to advise the federal government on scientific and technical matters. Dr. Ralph J. Cicerone is president of the National Academy of Sciences.

The **National Academy of Engineering** was established in 1964, under the charter of the National Academy of Sciences, as a parallel organization of outstanding engineers. It is autonomous in its administration and in the selection of its members, sharing with the National Academy of Sciences the responsibility for advising the federal government. The National Academy of Engineering also sponsors engineering programs aimed at meeting national needs, encourages education and research, and recognizes the superior achievements of engineers. Dr. Charles M. Vest is president of the National Academy of Engineering.

The **Institute of Medicine** was established in 1970 by the National Academy of Sciences to secure the services of eminent members of appropriate professions in the examination of policy matters pertaining to the health of the public. The Institute acts under the responsibility given to the National Academy of Sciences by its congressional charter to be an adviser to the federal government and, on its own initiative, to identify issues of medical care, research, and education. Dr. Harvey V. Fineberg is president of the Institute of Medicine.

The **National Research Council** was organized by the National Academy of Sciences in 1916 to associate the broad community of science and technology with the Academy's purposes of furthering knowledge and advising the federal government. Functioning in accordance with general policies determined by the Academy, the Council has become the principal operating agency of both the National Academy of Sciences and the National Academy of Engineering in providing services to the government, the public, and the scientific and engineering communities. The Council is administered jointly by both the Academies and the Institute of Medicine. Dr. Ralph J. Cicerone and Dr. Charles M. Vest are chair and vice chair, respectively, of the National Research Council.

The **Transportation Research Board** is one of six major divisions of the National Research Council. The mission of the Transportation Research Board is to provide leadership in transportation innovation and progress through research and information exchange, conducted within a setting that is objective, interdisciplinary, and multimodal. The Board's varied activities annually engage about 7,000 engineers, scientists, and other transportation researchers and practitioners from the public and private sectors and academia, all of whom contribute their expertise in the public interest. The program is supported by state transportation departments, federal agencies including the component administrations of the U.S. Department of Transportation, and other organizations and individuals interested in the development of transportation. [www.TRB.org](http://www.TRB.org)

[www.national-academies.org](http://www.national-academies.org)

## AUTHOR ACKNOWLEDGMENTS

These guidelines were developed under NCHRP Project 3-62. The University of North Carolina Highway Safety Research Center (HSRC) was the contractor for this study. Accessible Design for the Blind (ADB) was a subcontractor. Primary authors of this report are Janet Barlow (Principal, ADB), Billie L. Bentzen (Director of Research, ADB), David Harkey (Director, HSRC), and Daniel Carter (Research Engineer, HSRC). Mr. Harkey served as the Principal Investigator for this effort.

The authors wish to acknowledge the assistance and support of others who made this project a success. Several manufacturers of Accessible Pedestrian Signals (APS) provided invaluable donations of equipment, installation assistance, and technical expertise to this project:

- Campbell Company (Phil Tate),
- Novax Industries (Doug Gubbe),
- Polara Engineering (John McGaffey), and
- Prisma Teknik (Jan Lund and Fredrik Dahlberg).

Field data collection efforts were conducted in Tucson, Arizona; Charlotte, North Carolina; and Portland, Oregon. The authors wish to acknowledge the following city transportation departments and individuals for their support of the project and their tireless efforts to install and maintain the APS equipment through the duration of the project:

- City of Tucson, Arizona Traffic Engineering Department, particularly John Swanson, Bob Hunt, Ray Svec and Richard Nassi.
- City of Charlotte, North Carolina Transportation Department, particularly Tammy Drozd, Scott Lamont, Ken Bostick, Art Stegall, Justin Carroll, and Bill Dillard.
- City of Portland, Oregon Department of Transportation, particularly Bill Kloos, Jason McRobbie and Dave Grilley.

An expert panel reviewed this Guide and provided valuable feedback for its content. Panel members included Jose De Leon, Erin Duguay, Karissa Hoff, Scott Lamont, Jason McRobbie, Steve Misgen, Linda Myers, Kumar Neppalli, Ed Paulis, and Mike Switzer.

Their able assistance facilitated a smooth and enjoyable research experience for both researchers and participants.

## TABLE OF CONTENTS

Chapter 1—Introduction to APS .....	1
Chapter 2—Travel by Pedestrians Who Are Blind or Who Have Low Vision .....	13
Chapter 3—Understanding Traffic Signals and Modern Intersection Design .....	25
Chapter 4—Features of APS .....	47
Chapter 5—When to Install APS .....	81
Chapter 6—Designing APS Installations .....	93
Chapter 7—Installation, Operation, and Maintenance .....	135
Chapter 8—Public Education about APS .....	159
Chapter 9—U.S. Case Studies .....	167
Chapter 10—International Practice .....	203
Appendix A—Current Guidelines .....	217
Appendix B—Product Information .....	247
Appendix C—Research on APS .....	261
Appendix D—APS Prioritization Tool Instructions and Forms .....	299
Appendix E—Glossary .....	331



# Chapter 1:

## Introduction to Accessible Pedestrian Signals: Definition and Current Guidance

### CHAPTER SUMMARY

This chapter provides a definition of accessible pedestrian signals and an overview of their use. This chapter also includes an overview of standards development in the U.S. and current guidance.

### CHAPTER CONTENTS

Accessible Pedestrian Signals (APS) .....	2
History of APS in the U.S. ....	4
U.S. Legislation, Standards, and Guidance Applicable to APS .....	8

### ADDITIONAL REFERENCES

Appendix A includes the portions of the following references pertaining to APS.

*Manual on Uniform Traffic Control Devices (MUTCD)*

*Draft Public Rights-of-Way Accessibility Guidelines (Draft PROWAG)*



# Accessible Pedestrian Signals (APS)

## WHAT IS AN APS?

**Accessible Pedestrian Signal**—a device that communicates information about pedestrian timing in nonvisual format such as audible tones, verbal messages, and/or vibrating surfaces (*MUTCD*, Section 4A.02).

**Accessible Pedestrian Signal**—A device that communicates information about the WALK phase in audible and vibrotactile formats (*Draft PROWAG*, R105.5).

Note that the *Draft PROWAG* definition states that an APS provides information in both audible and vibrotactile formats, while the *MUTCD* says audible “and/or” vibrating surfaces.

**Figure 1-1. Examples of pushbutton-integrated APS from various manufacturers**



## OTHER TERMS

APS are known by different names in different countries:

- Acoustic signals
- Audio-tactile signals
- Audible pedestrian signals
- Audible traffic signals
- Audible pedestrian traffic signals
- Audible crossing indicators

## MAJOR FUNCTIONS OF APS

APS can provide information to pedestrians about:

- Existence of and location of the pushbutton
- Beginning of the WALK interval

- Direction of the crosswalk and location of the destination curb
- Intersection street names in Braille, raised print, or through speech messages
- Intersection signalization with a speech message
- Intersection geometry through tactile maps and diagrams, or through speech messages

## **BENEFITS OF APS**

Research has found that APS improved crossing performance by blind pedestrians.

- More accurate judgments of the onset of the WALK interval
- Reduction in crossings begun during DONT WALK
- Reduced delay
- Significantly more crossings completed before the signal changed

Sighted pedestrians also begin crossing faster.

See Appendix C for details of research.

## **USE IN THE U.S.**

Although audible crossing indicators have been available for over 25 years, they have not been commonly installed in the United States. This is probably attributable to two factors:

- Disagreement among blind people on the need for, and effectiveness, of audible pedestrian signals
- Noise pollution and consequent community opposition

In the past ten years, changes in intersection design and signalization (see Chapter 3) have affected the traditional street crossing techniques used by blind pedestrians, making the pedestrian phase harder to recognize without seeing the visual pedestrian signal. In addition, it has become essential to cross during the pedestrian phase at many intersections. These changes have led to more requests for APS and advocacy for their installation in recent years.

In addition, developments in technology have occurred. New types of APS have become available in the United States that provide more information and have addressed some of the previous noise concerns.

## **USE IN OTHER COUNTRIES**

In Japan, Australia, and some European countries, APS have been routinely installed at many intersections for at least 20 years.

Information about policies in these countries is included in Chapter 10, International Practice.

## History of APS in the U.S.

### APS BUT NO REGULATIONS

Although there are reports of audible pedestrian signals in the U.S. as early as 1920, they were not included in U.S. standards and regulations until *MUTCD* 2000.

- Common devices were bells or buzzers designed by engineers in response to a request from individuals who were blind.
- Earliest reported installations were near schools for the blind.

### APS FIRST MASS MARKETED

Mid 1970's

- Cuckoo/cheep signals mounted on the pedestrian signal heads (pedhead-mounted APS), based on a Japanese system, were marketed in the U.S. These signals emitted sound from an overhead speaker only during the WALK interval and were typically aimed toward the opposite end of the crosswalk.
- Other types of devices developed in Europe and Australia (see Chapter 10, International Practice, Sweden and Australia) were not marketed in the U.S.



**Figure 1-2. Pedhead-mounted APS; APS speaker mounted on top of pedestrian signal head**

### CONTROVERSY OVER THEIR USE

For early installations, there were complaints about noise of the signals from residents living near installations.

In addition, there was disagreement about the need for APS between two main consumer groups of blind people, American Council of the Blind and National Federation of the Blind. Until the early 1990's:

- American Council of the Blind (ACB) supported use of APS to provide additional information at all intersections.
- National Federation of the Blind (NFB) opposed all use of APS.

While each of these consumer groups have a membership of approximately 25,000 people which combined represents less than 1% of people who are blind or who have low vision in the U.S., this disagreement was often very confusing to community officials. While the NFB has now stated that APS should be used in some situations, they are still opposed to “wholesale” installation at every intersection.

### PROBLEMS WITH PEDHEAD-MOUNTED APS

See Appendix C for detailed information on research results.

Pedhead-mounted APS provide limited information.

- Two-sound system (cuckoo/cheep) does not provide unambiguous indication of WALK. Requires blind pedestrians to know their direction of travel at all times.
- They only provide sound during the WALK interval. While the signal sound is loud and intended to provide directional guidance across the street, the short duration of the WALK interval at most locations means that the sound ends before pedestrians complete their crossings.
- No information is supplied about the presence or location of the pushbutton.

## NEWER TYPES OF APS AVAILABLE – PUSHBUTTON-INTEGRATED

In the mid-1990's, APS that were integrated into the pushbutton, based on the European and Australian systems, began to be available in the U.S.

These APS provide audible indications from the pushbutton at a generally quiet volume, intended to be heard 6 to 12 feet from the pushbutton.

Additional features include:

- Vibrotactile WALK indication, in addition to audible WALK indications
- Pushbutton locator tone which repeats constantly at once per second to provide information about the presence and location of a pushbutton
- Tactile arrow that points in the direction of travel on the crosswalk
- Automatic volume adjustment, so the APS responds to ambient sound and provides louder indications when the traffic is louder and quieter signals at times when traffic is quiet

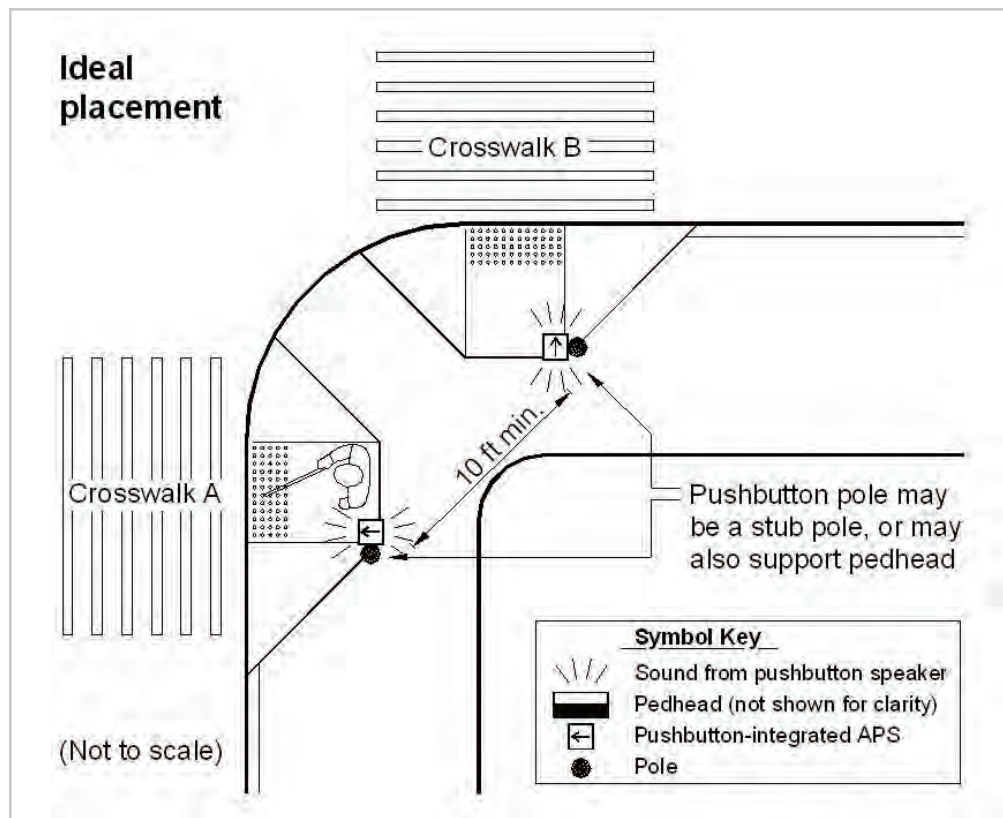


**Figure 1-3. Pushbutton-integrated APS**

## PROPER LOCATION IS ESSENTIAL

The functioning of pushbutton-integrated APS is based on proximity to the crosswalk location. The closer the APS is located to the departure location, the quieter it can be. In addition, the vibrotactile indication and tactile arrow are not usable when located too far back from the street. Figure 1-4 illustrates installation recommendations.

**Figure 1-4. Ideal Installation – Within 5 feet of the crosswalk extended, within 10 feet of the curb, and separated by more than 10 feet from other APS on the corner, adjacent to a level landing**



## CHANGES IN INTERSECTION DESIGN, TRAFFIC AND SIGNALIZATION

Changes in intersection design, traffic, and signalization have affected the ability of pedestrians who are blind to cross streets using traffic sounds, as discussed in detail in Chapter 2.

## APS CURRENTLY AVAILABLE IN THE U.S.

APS provide an auditory (tone or speech) indication of the WALK interval. Vibrotactile indication of the WALK interval is required by the *Draft PROWAG*, but not all APS devices are capable of providing vibrotactile indications. Numerous other features are available and detailed descriptions of the various features can be found in Chapter 4.

In the previous version of this document (*Accessible Pedestrian Signals: Synthesis and Guide to Best Practice*), APS were described as one of four design types: pedhead-mounted, pushbutton-integrated, vibration-only, and receiver-based. These device design types were mainly categorized by the location and type of WALK indication provided, although there were characteristic differences in other features at that time. As technology has developed, several combinations of these different types have emerged, and modifications have been made that prevent easy separation of devices into four ‘types’. The discussion of APS and their features using those terms becomes confusing. This Guide, *Draft PROWAG*, and the *MUTCD* all recommend APS that have audible and vibrotactile WALK indications, which are only available

when APS are integrated into the pushbutton. However, other features, such as additional beaconing speakers, may also be provided.

In this Guide, other than this chapter and Chapter 9, the labeling of types of APS has generally been dropped. These types are described here for clarification, as background information. Some manufacturers or distributors may continue to use these terms to describe available products.

#### Pushbutton-integrated

- Common in Europe and Australia and rapidly becoming common in the U.S.
- Speaker and vibrating surface located at the pushbutton
- A regularly repeating quiet locator tone provides information about the presence of the pushbutton and its location, (during the flashing and steady DONT WALK intervals).
- Pushbutton locator tone and WALK indication volumes respond to ambient sound
- Volume is typically adjusted to be heard only at the beginning of crosswalk
- May provide other information about the name of streets or the geometry of the intersection, or signalization

#### Pedhead-mounted

- Most common type installed between 1960 and 2000 in the U.S.
- Speaker mounted on top of the pedestrian signal head (pedhead)
- Bell, buzzer, cuckoo, cheep, tone, or verbal message during the WALK interval only
- Usually intended to be heard across the street and act as a beacon, thus are relatively loud

#### Receiver-based

- Message transmitted by infrared or LED technology from the pedestrian signal to a personal receiver held by the individual
- Blind pedestrians must have and use the appropriate receiver for the technology installed
- May provide other information about the name of streets, geometry of the intersection, direction of travel, and address information

#### Vibrotactile-only

- Arrow on the pushbutton housing or the pushbutton itself vibrates during the WALK interval
- Vibrotactile-only devices are no longer available in the U.S., and do not conform to *Draft PROWAG*

# U.S. Legislation, Standards, and Guidance Applicable to APS

## TRANSPORTATION EQUITY ACT FOR THE 21ST CENTURY

The Transportation Equity Act for the 21st Century (TEA-21) stated that pedestrian safety considerations should be included in new transportation plans and projects.

- Section 1202 (g)(2) directed that they “...shall include the installation, where appropriate, and maintenance of audible traffic signals and audible signs at street crossings.”
- Required that FHWA develop guidance on pedestrian and bicycle facility design. A Policy Statement on Accommodating Bicyclists and Pedestrians in Transportation Projects was written, which includes the following statement: “Sidewalks, shared use paths, street crossings (including over- and undercrossings), pedestrian signals, signs, street furniture, transit stops and facilities, and all connecting pathways shall be designed, constructed, operated and maintained so that all pedestrians, including people with disabilities, can travel safely and independently”. (TEA-21, 1998)

## MUTCD

The *MUTCD* (2003) includes two sections on Accessible Pedestrian Signals, Part 4E.06, Accessible Pedestrian Signals, and Part 4E.09, Accessible Pedestrian Signal Detectors. In addition, 4D.03, Provisions for Pedestrians, addresses the need for accessible pedestrian signals in the following standards and guidance:

*Standard:*

*The design and operation of traffic control signals shall take into consideration the needs of pedestrian as well as vehicular traffic.*

*If engineering judgment indicates the need for provisions for a given pedestrian movement, signal faces conveniently visible to pedestrians shall be provided by pedestrian signal heads or a signal face for an adjacent vehicular movement.*

*Guidance:*

*Safety considerations should include the installation, where appropriate, of accessible pedestrian signals (see Sections 4E.06 and 4E.09) that provide information in nonvisual format (such as audible tones, verbal messages, and/or vibrating surfaces).” (MUTCD, 2003)*

## MUTCD Sections on APS

Section 4E.06 includes standards for APS use, guidance on installation of APS, and standards and guidance on WALK indications and features of APS.

Section 4E.09 provides standards and guidelines that address features and locations of accessible pedestrian signal detectors (pushbuttons), pushbutton locator tones and volume of signals.

### ***MUTCD Revisions***

The Federal Highway Administration publishes the *MUTCD*, with revisions made on a regular basis. Major input to the *MUTCD* is provided by the National Committee on Uniform Traffic Control Devices (NCUTCD), which meets twice a year to consider revisions.

Changes to the *MUTCD* are published in the Federal Register as a Notice of Proposed Rulemaking (NPA); followed by a comment period, and other standard Federal rulemaking procedures. The next major revision of the *MUTCD* is expected to be completed in 2009. On January 2, 2008, Federal Highway Administration published an NPA for the *MUTCD* (pdf dated December 2007) and the comment period closed on July 31, 2008. Comments are being analyzed. A Final Rule for the next edition of the *MUTCD* is anticipated during 2009. The NPA contained major revisions to the *MUTCD* sections on APS. Where appropriate, those provisions are referenced in this document as Proposed *MUTCD*.

The *MUTCD* is available at <http://mutcd.fhwa.dot.gov>

The 2003 *MUTCD* sections on APS, and Proposed *MUTCD* sections are included in Appendix A.

## **SECTION 504 OF THE REHABILITATION ACT OF 1973**

The requirement for nondiscrimination on the basis of disability dates from well before TEA-21 or the Americans with Disabilities Act. Section 504 of the Rehabilitation Act of 1973 prohibits discrimination on the basis of disability in programs and activities receiving or benefiting from federal financial assistance.

“No qualified handicapped person shall...be denied the benefits of...any program or activity that receives or benefits from Federal financial assistance administered by the DOT.” (Rehabilitation Act, 1973)

The Act specifically required the installation of curb ramps on federally funded projects.

## **AMERICANS WITH DISABILITIES ACT OF 1990**

The Americans with Disabilities Act (ADA) is a landmark law that protects the civil rights of persons with disabilities. It prohibits discrimination on the basis of disability in employment, State and local government services, transportation, public accommodations, commercial facilities, and telecommunications. The ADA has five parts:



- Title I—Employment
- Title II—Public Services - State and local government services
- Title III—Public Accommodations and services operated by private entities—public accommodations (businesses and non-profit agencies that serve the public) and commercial facilities (other businesses).
- Title IV—Telecommunications—telephone services
- Title V—Miscellaneous provisions

The ADA applies to all programs and facilities of state and local government, regardless of funding source.

Guidelines for implementation of each part of the ADA were developed by agencies charged with that responsibility.

- The U.S. Access Board (Architectural and Transportation Barriers Compliance Board) develops and maintains accessibility guidelines for buildings, facilities, and transit vehicles covered by titles II and III of the ADA. These guidelines are known as the ADA Accessibility Guidelines (ADAAG).
- ADAAG serves as the basis of enforceable standards issued by the Departments of Justice (DOJ) and Transportation (DOT)

## **ADAAG AND PUBLIC RIGHTS-OF-WAY**

Implementing regulations of Title II of the ADA require state and local government programs and properties to be accessible to persons with disabilities.

- ADAAG provides minimum technical provisions for access. The guidelines implementing the ADA were published in 1991, and adopted as final rule (an enforceable standard) by the DOJ and DOT in 1992.
- The section on Public Rights-of-Way, Section 14, was not issued as a final rule at that time.

## **ADA STANDARDS DEVELOPMENT PROCESS**

The development of accessibility standards is a long process with numerous opportunities for public input and comment. The development of public rights-of-way standards is under way, but probably will not be completed for several more years.

- Public Rights-of-Way Access Advisory Committee (PROWAAC) was formed by the Access Board in 1999 to develop recommendations for public rights-of-way.
- Recommendations were provided in a report to the Access Board, completed in 2001, *Building a True Community: Final Report—Public Rights-of-Way Access Advisory Committee*. Discussion and advisory notes in that document may be helpful in understanding some of the provisions in *Draft PROWAG*.
- The Access Board took the PROWAAC recommendations and developed *Draft Public Rights-of-Way Accessibility Guidelines*. *Draft PROWAG* was published

on June 17, 2002 for comment. A revised draft was published on November 23, 2005. The sections of the *Draft PROWAG* on APS are included in Appendix A.

- This draft will be followed by a Regulatory Analysis (RA) of the cost of implementing the rule and development of text, commentary, figures, and preamble of guidelines. After approval of a rule by the Access Board, the RA and rule are reviewed by the Office of Management and Budget before release for publication.
- A Notice of Proposed Rulemaking (NPRM) will be published in the Federal Register. After publication, comments will be solicited, and staff and the Access Board will evaluate the public comments and propose any changes deemed necessary. After that, final guidelines will be approved and issued by the Access Board, and eventually be adopted as standards by DOJ and DOT
- Information on progress and the process is posted at [www.access-board.gov](http://www.access-board.gov) under Public Rights-of-Way.

## DRAFT PROWAG SECTIONS ON APS

Section R208 requires APS where pedestrian signals are installed

Section R306 provides specifications regarding WALK interval indications, location of devices, volume, pushbutton locator tones, pushbutton operation, size and contrast, signs and tactile arrows, and optional features.

Further description and details can be found in Chapter 6.

## RESPONSIBILITY UNDER ADA IMPLEMENTING REGULATIONS

ADA implementing regulations require programs of state and local governments to be accessible. *Barden v. Sacramento*, a 2004 court decision, defined sidewalks and street crossings as a program and facility of the state and local government, which must be accessible under Title II of the ADA.

There are several specific sections of the ADA implementing regulations that require accessibility:

- Title II, Subpart D—Program Accessibility, 35.151 New construction and alterations states that: “Each facility ...constructed by, on behalf of, or for the use of a public entity shall be designed and constructed in such manner that the facility...is readily accessible to and usable by individuals with disabilities...”
- “Readily accessible to and usable by” means: ...that it can be approached, entered, and used by individuals with disabilities (including mobility, sensory, and cognitive impairments) easily and conveniently. ...To the extent that a particular type or element of a facility is not specifically addressed by the standards, [the above] language...is the safest guide.
- ADA Title II: State and Local Government Services, Subpart E—Communications, 35.160 General. “A public entity shall take appropriate steps to ensure that communications with...members of the public with disabilities are as effective as communications with others.”

The bottom line is that ADA requires newly constructed facilities to be accessible even if there are no specific guidelines covering that type of facility. ADA compliance is a civil rights issue.

## **DRAFT PROWAG AS BEST PRACTICES**

In a memo published January 26, 2006, the Federal Highway Administration states: “The Draft Guidelines are not standards until adopted by the U.S. Department of Justice and the U.S. Department of Transportation. The present standards to be followed are the ADA Accessibility Guidelines (ADAAG) standards. However, the Draft Guidelines are the currently recommended best practices, and can be considered the state of the practice that could be followed for areas not fully addressed by the present ADAAG standards. Further, the Draft Guidelines are consistent with the ADA’s requirement that all new facilities (and altered facilities to the maximum extent feasible) be designed and constructed to be accessible to and useable by people with disabilities.” (Isler memo, 2006)

Note: The “Draft Guidelines” to which the FHWA memo refers are referred to as “*Draft PROWAG*” throughout this Guide.

# Chapter 2:

## Travel by Pedestrians Who are Blind or Who Have Low Vision

### CHAPTER SUMMARY

This chapter provides demographic information about individuals who are blind or who have low vision, and information about types of vision loss. Travel techniques are explained and the effect of changes in traffic control and signalization on the travel of pedestrians who are blind or visually impaired is discussed.

### CHAPTER CONTENTS

Blindness and Vision Loss .....	14
Travel Tools and Techniques of People Who are Blind or Who Have Low Vision .....	18
How People Who are Blind or Visually Impaired Cross Streets .....	21
Changes in the Travel Environment .....	24

# Blindness and Vision Loss

## DEFINITIONS

**Visual impairment:** a functional limitation in seeing, including both those with:

- “non-severe limitation” (“difficulty seeing words and letters”) and
- those with “severe limitation” (“unable to see words and letters”).

**Legal blindness:** a level of visual impairment that has been defined by law to determine eligibility for benefits.

Legal blindness refers to central visual acuity of 20/200 or less in the better eye with the best possible correction, as measured on a Snellen vision chart, or a visual field of 20 degrees or less.

Vision correctable to 20/20 with at least 180-degree field is considered ‘normal vision’. A simplified example of visual acuity is that a person who is legally blind with 20/200 vision sees at approximately 20 feet what a person with 20/20 vision sees at 200 feet. A person with a visual field of 20 degrees or less is able to see no more than a 20-degree field without scanning.

## TYPES OF VISION LOSS

General types of vision loss

- Reduced acuity
- Restricted fields (central or peripheral)
- Combination of reduced acuity and restricted fields
- Total blindness or light perception only

Reduced acuity can refer to a large range of functional vision from vision tested as 20/20 to totally blind. Lighting and contrast affect functional vision and are not reflected in the clinical measurements.

The general category of restricted fields can be further divided into central field loss and peripheral field loss.

## REDUCED ACUITY

The picture below represents a street crossing as it might be seen by a person with general reduced visual acuity. An overall loss of acuity, sensitivity to glare, and loss of contrast sensitivity is common in the elderly population.



**Figure 2-1. A street crossing as might be seen by a person with general reduced visual acuity**

## CENTRAL FIELD LOSS

Individuals with a central field loss usually will have difficulty seeing pedestrian signals, some signs, and details directly in front of them. Central field loss is typical of macular degeneration, the leading cause of blindness in those over 60.



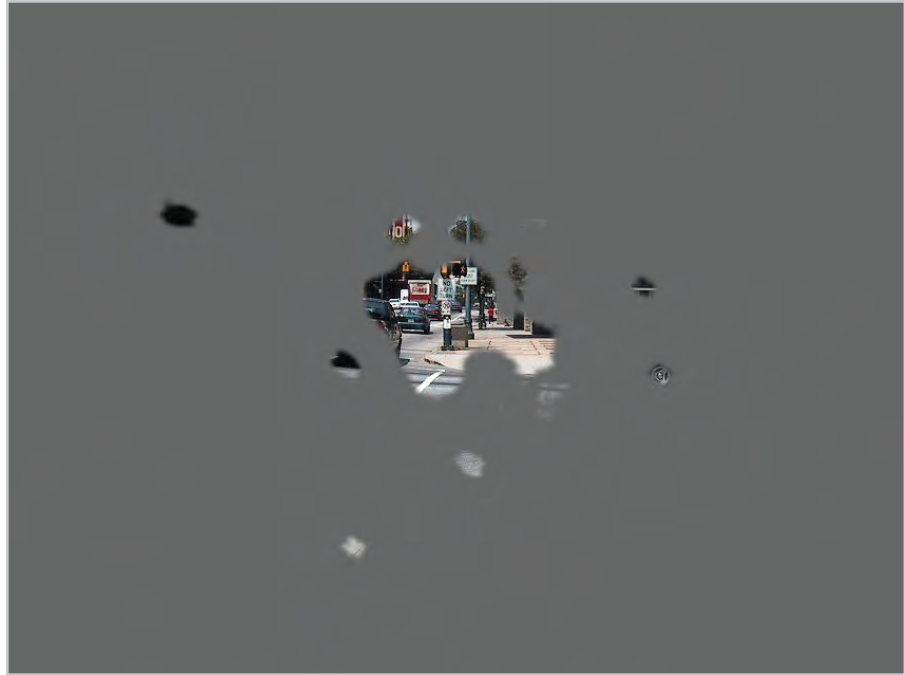
**Figure 2-2. The same street crossing as might be seen by a person with central field loss**

## PERIPHERAL FIELD LOSS

Individuals with peripheral field loss, sometimes referred to as tunnel vision, may see details directly in front of them clearly, but have difficulty with objects and signs off to the side. In addition, depth perception is often impaired.

Glaucoma and retinitis pigmentosa are the main causes of peripheral field loss.

**Figure 2-3. The same street crossing as might be seen by a person with peripheral field loss**



## DECREASE IN ATTENTIONAL FIELD

Research by Brabyn, Haegerström-Portnoy, Schneck, and Lott (Brabyn et al., 2000), demonstrated that over age 60-65 the prevalence of problems detecting objects in the peripheral visual field increases dramatically. This is known as a decrease in attentional field, and it may be present with or without other types of visual impairment. By age 90, 40% of people have an attentional field of less than 10 degrees left and right. Thus, if they are looking at a pedestrian signal head, they are unlikely to be visually aware of vehicles that may be turning across their path of travel, until it is too late to take appropriate action.

## TOTAL BLINDNESS OR LIGHT PERCEPTION

Individuals who are considered totally blind usually cannot see any difference in light and dark. Individuals who have light perception may be able to tell if it is dark or light and the direction of a bright light source, but do not have vision that is useable for discerning objects or the travel path.

## PREVALENCE OF BLINDNESS

Different sources provide different estimates of the prevalence of blindness in the U.S. There is no registry of individuals with vision loss in the U.S. and different methodologies are used to derive these estimates. Adams, Hendershot, & Marano (1999) estimate that some degree of vision impairment affects 8.3 million (3.1%) Americans of all ages.

Centers for Disease Control and Prevention (CDC) states that more than one million Americans are legally blind and 12 million are visually impaired. It is projected that the number of blind and visually impaired people will double by 2030 (CDC, 2003).

The Lighthouse National Survey reports that 8.7 million (9%) Americans age 45 and older report a severe vision impairment, defined as an inability to recognize a friend at arm's length even when wearing corrective lenses; an inability to read ordinary newspaper print with corrective lenses; poor or very poor vision even when wearing corrective lenses; or blindness in both eyes. (The Lighthouse Inc., 1995).

A Health and Activity Limitations post-censal survey (HALS) by Statistics Canada reported that 635,000 Canadians identified themselves as having a “seeing disability” (HALS, 1995).

Of the 635,000 Canadians with a seeing disability:

- 511,000 were adults living in households
- 94,000 were adults living in institutions
- 30,000 of these were children aged 14 years and under

## AREA OF RESIDENCE

Of people with vision impairments, 33% live in cities, 37% live in suburbs, 28% live in non-metropolitan areas (e.g., small towns) and 1% live in farm areas (Schmeidler & Halfmann, 1998). In comparison to the general population, persons who are visually impaired are somewhat under-represented in the suburbs (i.e., 48% of general population live in suburbs vs. 37% of visually impaired) and over-represented in cities.



# Travel Tools and Techniques of People Who are Blind or Who Have Low Vision

## SEVERAL CHOICES

People who are blind or visually impaired make choices when it comes to traveling. At any given time, they can travel using a human guide, which involves holding onto someone's arm; using a long, white cane to identify and avoid obstacles or elevation changes; using a dog guide; using special optical or electronic aids; or using no additional aid.

The choice of tools depends on the extent and nature of visual impairment, personal preference, lighting, and familiarity with the area.

In order to travel independently, people with visual impairments use whatever vision they have, auditory and tactual information, and any gathered knowledge of an area to keep track of their location and make travel decisions.

## HUMAN GUIDE (SOMETIMES REFERRED TO AS SIGHTED GUIDE)

At one time or another, most people who are blind will make use of the human guide technique, in which a person with sight serves as a guide to a person who is blind or visually impaired.

## LONG WHITE CANE

Many individuals who are blind or visually impaired use a long white cane as a mobility device. In the most common technique, the cane is extended and swung back and forth across their body in rhythm with their steps to provide information about the environment directly in front of them, such as elevation changes or obstacles. In another technique often used by people with low vision, the cane is held diagonally across their body, with the tip about an inch above the ground. When those individuals are unsure about what they are seeing, they usually check the object or sidewalk surface with their cane.

## DOG GUIDE

Dog guides are carefully trained service animals used as travel tools by approximately 2% of people who are blind. The dog responds to the commands of its handler, such as right, left and forward. The dog guides the handler around obstacles and stops at curbs or stairs. However, the handler must know where they are going and make decisions about the proper time to begin a street crossing. Dog guides move in response to directions from their handlers but may disobey commands to avoid danger.



**Figure 2-4. Pedestrian with long white cane**



**Figure 2-5. Pedestrian with dog guide**

## **NO AID**

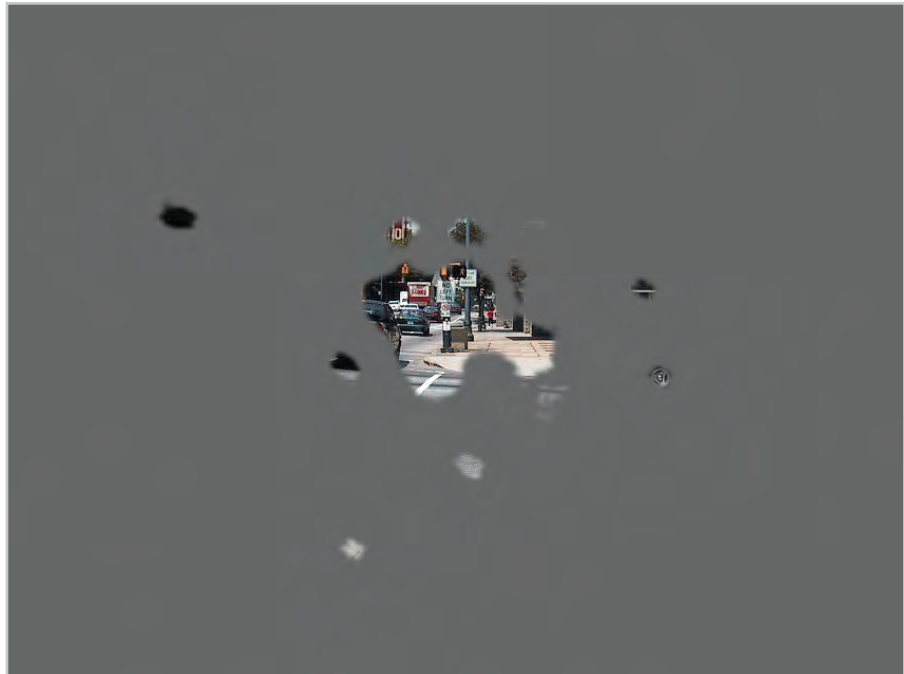
Not all persons considered blind use a long white cane or dog guide. People who are visually impaired often rely on their remaining sight and auditory and tactile cues in their surroundings for orientation and travel. Some may also use aids such as telescopes for specific tasks.

## **ORIENTATION AND MOBILITY TRAINING**

Many pedestrians who are visually impaired or blind have received orientation and mobility training, provided by an Orientation and Mobility (O&M) Specialist. O&M Specialists usually have an undergraduate or graduate degree in teaching travel skills to persons who have visual impairments.

Orientation is the ability to understand where one is located in space and Mobility refers to being able to travel through that space safely. The goal of most O&M training is to prepare a person who is visually impaired to travel in a variety of environments, both familiar and unfamiliar, and to assess new intersections and travel new routes. It is important to note that orientation training and assistance is not provided for every route that a person who is blind needs to travel.

**Figure 2-6. Visually impaired pedestrian crossing street with Orientation and Mobility Specialist**



# How People Who are Blind or Visually Impaired Cross Streets

## TRADITIONAL TECHNIQUES

Techniques and cues used in crossing streets are diverse and vary by the type of location and by the individual and his or her level of vision. Individuals who are blind or visually impaired often travel to unfamiliar areas and intersections and gather information from available sources in order to do so safely.

The discussion of techniques below describes typical techniques used at unfamiliar intersections, although most travel by pedestrians who are blind is probably on routes with which they are familiar. However, it is also not uncommon for bus drivers or taxi drivers to provide incorrect information about the location or drop off a person at a slightly different location than expected, so it is necessary to regularly confirm information using nonvisual techniques described below.

Once pedestrians who are blind are familiar with an intersection, they do not usually need to analyze the intersection and traffic control system at length every time. However, they still may need to listen long enough to determine that they are at the correct location and that the signal is functioning as usual. Pedestrians who are blind will still need to detect the street, align to cross, identify the WALK interval, and maintain alignment while crossing. APS can particularly assist with the task of identifying the WALK interval at familiar and unfamiliar locations.

## DETECTING THE STREET

The first information needed by pedestrians who are blind is **“Have I arrived at a street?”** People who are blind or visually impaired use a combination of cues to recognize the street edge. These may include:

- Curb or the slope of the ramp
- Truncated dome detectable warnings, if available
- End of building line and open sound of the intersection
- Sound of traffic on the street beside them (the parallel street)
- Sound of traffic stopping on the street they are approaching (the perpendicular street)
- Presence of pedestrians
- Presence of an intersecting sidewalk

## IDENTIFYING THE STREET

The next information needed for decision-making at unfamiliar intersections is: **“Which street is this?”**

- This information is only occasionally provided in any accessible format.
- Pedestrians who are visually impaired develop a mental map and keep track of where they are within that map, usually by counting blocks and street crossings.
- Where necessary, and available, assistance may be sought from other pedestrians.

## **ANALYZING INTERSECTION GEOMETRY**

The next information needed is: **“What is the geometry of this intersection?”** including:

- Is my destination curb straight in front of me, or must I angle to the left or right to reach it?
- How many streets intersect here?
- How wide is this street?
- Should I expect to encounter any islands or medians as I cross this street?
- Am I standing within the crosswalk?

This information may be immediately available to pedestrians having full vision, but it may not be possible for pedestrians who are blind to determine this information by listening to traffic patterns. Incorrect or missing information for any of these questions may result in missing the destination curb or median.

## **ANALYZING THE TRAFFIC CONTROL SYSTEM**

Next, pedestrians with visual impairments need to know: **“What is the type of traffic control system at this intersection?”**, including:

- Is this a signalized intersection?
- Do I need to push a button to actuate the WALK interval? If so, where is the button?
- Is the button close enough to the crosswalk that I will have time to push the button, position myself correctly at the crosswalk, and reestablish my alignment facing the destination curb before the onset of the WALK interval?
- Which button controls the WALK interval for the street I want to cross?
- Does it stop traffic on one street, or all traffic?
- Do cars still turn during the WALK interval?
- Is there a second button on the median or crossing island that I must push?
- Will there be a surge of parallel traffic telling me the WALK interval has begun? Will I be able to hear it over other, concurrent traffic sounds?

Techniques for gathering this information include listening to traffic patterns through several signal cycles and searching the sidewalk area for poles with

pushbuttons. Missing information for any of these questions may result in failure to use pedestrian pushbuttons, not beginning the crossing during the WALK interval, not completing the crossing before perpendicular traffic begins moving, and crossing at times other than the pedestrian phase.

## ALIGNING TO CROSS

Before starting to cross, the pedestrian must align to cross or choose a heading for the crossing. Typical techniques for this task include maintaining the alignment used on the approach to the intersection and listening to parallel traffic through a signal cycle to confirm alignment to parallel traffic. The need to use pedestrian pushbuttons often prevents the use of parallel traffic for alignment. After pushing the button, the pedestrian must cross on the next pedestrian phase, which is usually the next time that traffic begins moving parallel to the pedestrian's crosswalk.

## IDENTIFYING THE WALK INTERVAL

After determining the geometry of the intersection, aligning to face towards the destination curb, determining that the intersection is signalized and having pushed a button, where necessary, pedestrians who are blind need to know: **“When does the WALK interval begin?”**

In the most common technique utilized for crossing at signalized intersections, pedestrians who are blind or visually impaired begin to cross the street when there is a surge of traffic on the street parallel to their direction of travel. This technique is dependent upon the presence of traffic and consistent signal phasing. Various types of phasing and intermittent or low volumes of traffic traveling parallel to the pedestrian may affect the reliability of that technique.

## MAINTAINING CROSSING ALIGNMENT

Once the pedestrian who is blind has begun to cross the street, the next question is: **“Am I headed straight towards my destination curb?”**

- Traffic going in the same direction on the parallel street provides helpful auditory guidance to many persons if it is present. In addition, pedestrians who are blind may use traffic waiting on the perpendicular street as a partial alignment cue.
- Turning traffic can make it difficult to hear and align with the traffic traveling straight through the intersection.

In the absence of traffic on the parallel street, pedestrians who are blind are more likely to veer toward or away from the intersection.

# Changes in the Travel Environment

## TYPES OF CHANGES

In the past twenty years, significant changes in intersection geometry, signalization, driver behavior, and the technology of automobiles have affected the ability of blind travelers in the United States to use the above-mentioned techniques.

## INTERSECTION DESIGN CHANGES AND THEIR EFFECT ON TRAVEL TECHNIQUES

- Wider streets require more precise alignment.
- Large radius corners make alignment more difficult and increase crosswalk length.
- Curb ramps and depressed corners make street detection and alignment difficult.
- Medians and islands complicate wayfinding and alignment.
- Presence of slip lanes and splitter islands requires crossing in gaps in traffic even at signalized intersections.
- Crosswalk alignment is not consistent.
- Curb extensions, also called bulb-outs or intersection chokers, sometimes complicate wayfinding.
- Raised crosswalks and tabled intersections may obliterate the sidewalk/street boundary.

## DRIVER BEHAVIOR AND TECHNOLOGY OF AUTOS

- Aggressive and inattentive drivers are moving faster and less likely to stop for pedestrians.
- The technology of cars, including hybrid and electric cars, has become quieter, making them harder for pedestrians who are visually impaired to hear.
- In many areas there is less pedestrian traffic and drivers are less aware of pedestrians.

## SIGNALIZATION CHANGES

Intersection signalization has become more complex. Details on signalization and the effect on travel by pedestrians who are blind are provided in Chapter 3.

# Chapter 3:

## Understanding Traffic Signals and Modern Intersection Design

### CHAPTER SUMMARY

This chapter provides a description of the terminology and characteristics of traffic signals and intersection design. It is intended to educate Orientation and Mobility (O&M) Specialists who must interact with the travel environment and traffic engineers but who may not be familiar with all the terminology and design techniques.

### CHAPTER CONTENTS

Introduction .....	26
MUTCD Warrants and Signalization .....	26
Intersection Signalization and Timing Plans .....	30
Vehicular Signals and Timing .....	36
Pedestrian Signals and Timing .....	39
Collaboration .....	43



## Introduction

Intersections and signals have become more complex and it is important that Orientation and Mobility (O&M) Specialists and blind travelers understand these changes for safe travel. Skills and strategies used by pedestrians who are blind or visually impaired to cross streets at signalized intersections were developed at intersections that had pretimed signals, which meant the signal changed on a regular basis. Signalization has also become more complex, with the introduction of vehicular and pedestrian actuation and multiple phases. This increased complexity has made some previously accessible intersections now inaccessible for pedestrians with visual impairments.

It is essential for O&M Specialists to understand these changes so that they are incorporated into their curriculum and so that these specialists can adapt their instructional techniques and advocate for their consumers' needs.

This chapter gives an overview of the decisions, design, and terms that are used by traffic engineers as they design and install traffic signals.

## MUTCD Warrants and Signalization

### WHAT IS A SIGNAL WARRANT?

A warrant is a condition that an intersection must meet to justify a signal installation. The Manual on Uniform Traffic Control Devices (*MUTCD*) specifies eight "traffic control signal needs studies", known as warrants. However, "The satisfaction of a traffic signal warrant or warrants shall not in itself require the installation of a traffic control signal." (*MUTCD*, 4C.01) The final decision is made based upon the traffic engineer's judgment.

### PROCESS TO DETERMINE IF SIGNAL IS WARRANTED

The traffic engineer analyzes vehicle traffic volume, pedestrian activity, intersection crash history, and the physical environment in order to determine whether or not the intersection warrants a traffic control signal.

Engineers examining the intersection may review the following:

- Number of vehicles entering the intersection from all directions during 4-hour and 8-hour periods
- Vehicular volumes during peak hours, classified by vehicle type for traffic movement in all directions
- Pedestrian volume on each crosswalk in all directions, including children, the elderly, and/or persons with disabilities, during each hour of the day

- Requests from participants attending nearby facilities and activity centers that serve the young, elderly, and/or persons with disabilities
- Posted speed limit
- Physical layout
- Crash experience/history

Different warrants require detailed analysis of different aspects of the above information.

## EXAMPLES OF SIGNAL WARRANTS

Information on two of the signal warrants is included below to illustrate some of the considerations.

### *Warrant 1 — Eight- Hour Vehicular Volume*

Engineers evaluate the vehicles per hour and a certain volume must be met in order to justify installation. A complex table is used that includes the number of lanes of moving traffic for each approach, vehicles per hour on the major street, and vehicles per hour on the higher volume minor street approaches.

Standard (*MUTCD*, Section 4C.02):

The need for a traffic control signal shall be considered if an engineering study finds that one of the following conditions exist for each of any 8 hours of an average day (See Table 3-1):

- The vehicles per hour given in both of the 100 percent columns of Condition A in Table 3-1 exist on the major-street and the higher-volume minor-street approaches, respectively, to the intersection; or
- The vehicles per hour given in both of the 100 percent columns of Condition B in Table 3-1 exist on the major-street and the higher-volume minor-street approaches, respectively, to the intersection.

In applying each condition the major-street and minor-street volumes shall be for the same 8 hours. On the minor street, the higher volume shall not be required to be on the same approach during each of these 8 hours.

Option: If the posted or statutory speed limit or the 85th-percentile speed on the major street exceeds 70 km/h (40 mph), or if the intersection lies within the built-up area of an isolated community having a population of less than 10,000, the traffic volumes in the 70 percent columns in Table 3-1 may be used in place of the 100 percent columns.

**Table 1.**  
**Applicable Variables for**  
**Mid-Block Crossings**

<b>CONDITION A —MINIMUM VEHICULAR VOLUME</b>							
<b>Number of lanes for moving traffic on each approach</b>		<b>Vehicles per hour on major street (total of both approaches)</b>			<b>Vehicles per hour on higher-volume minor-street approaches (one direction only)</b>		
Major Street	Minor Street	100% <sup>a</sup>	80% <sup>b</sup>	70% <sup>c</sup>	100% <sup>a</sup>	80% <sup>b</sup>	70% <sup>c</sup>
1	1	500	400	350	150	120	105
2 or more	1	600	480	420	150	120	105
2 or more	2 or more	600	480	420	200	160	140
1	2 or more	500	400	350	200	160	140
<b>CONDITION B—INTERRUPTION OF CONTINUOUS TRAFFIC</b>							
<b>Number of lanes for moving traffic on each approach</b>		<b>Vehicles per hour on major street (total of both approaches)</b>			<b>Vehicles per hour on higher-volume minor-street approaches (one direction only)</b>		
Major Street	Minor Street	100% <sup>a</sup>	80% <sup>b</sup>	70% <sup>c</sup>	100% <sup>a</sup>	80% <sup>b</sup>	70% <sup>c</sup>
1	1	750	600	525	75	60	53
2 or more	1	900	720	630	75	60	53
2 or more	2 or more	900	720	630	100	80	70
1	2 or more	750	600	525	100	80	70

- a Basic minimum hourly volume.
- b Used for combination of Conditions A and B after adequate trial of other remedial measures.
- c May be used when the major-street speed exceeds 70 km/h (40 mph) or in an isolated community with a population of less than

### **Warrant 4 — Pedestrian Volume**

Engineers evaluate the level of pedestrian activity at an intersection to see if a signal is warranted. The *MUTCD* describes Warrant 4 as “The Pedestrian Volume signal warrant is intended for application where the traffic volume on a major street is so heavy that pedestrians experience excessive delay in crossing the major street.” (*MUTCD*, 4C.05)

As currently written, the warrant requires a fairly large volume of pedestrians crossing at a location.

“The need for a traffic control signal at an intersection or mid-block crossing shall be considered if an engineering study finds that both of the following criteria are met:

- The pedestrian volume crossing the major street at an intersection or mid-block location during an average day is 100 or more for each of any 4 hours or 190 or more during any 1 hour; and
- There are fewer than 60 gaps per hour in the traffic stream of adequate length to allow pedestrians to cross during the same period when the pedestrian volume criterion is satisfied. Where there is a divided street having a median of sufficient width for pedestrians to wait, the requirement applies separately to each direction of vehicular traffic.” (*MUTCD*, 4C.05)

In addition:

- “The Pedestrian Volume signal warrant shall not be applied at locations where the distance to the nearest traffic control signal along the major street is less than 90 m (300 ft), unless the proposed traffic control signal will not restrict the progressive movement of traffic.” (*MUTCD*, 4C.05)

However:

- “The criterion for the pedestrian volume crossing the major roadway may be reduced as much as 50 percent if the average crossing speed of pedestrians is less than 1.2 m/sec (4 ft/sec).” (*MUTCD*, 4C.05)

## FOR MORE INFORMATION

The current *MUTCD* can be downloaded from the following website:

<http://mutcd.fhwa.dot.gov/>

# Intersection Signalization and Timing Plans

## INTERSECTION SIGNALIZATION

Intersections are generally designed to provide optimal vehicle traffic flow. Timing plans may be of two general types:

- fixed time (or pretimed)
- actuated

A signal at a given intersection may be designed to change from actuated to pretimed to flashing mode depending upon:

- time of day (peak periods vs. non-peak periods);
- day of week; and
- malfunctions due to power outages.

It is important for O&M Specialists to understand the signal design and terminology to teach these concepts to their students.

There is some variability in timing plans in different municipalities and in different locations, depending on the roadway needs and local practices.

## SIGNAL DESIGN TERMS

**Phase**—the right-of-way, yellow change, and red clearance intervals in a cycle that are assigned to an independent traffic movement or combination of movements

**Interval**—the part of a signal cycle during which signal indications do not change

- In other words, a phase is the time allotted to a specific movement, such as northbound traffic, whereas an interval is how long the light stays green, yellow, or red for vehicles or WALK, flashing DONT WALK, or DONT WALK for pedestrians.
- Busier intersections typically have separate phases for left turn movements (i.e., protected left turns). When a major road intersects a minor road, the green intervals for the major road will be longer than those for the minor road to accommodate the heavier traffic on the major road.
- Although the *MUTCD* gives specific definitions to “phase” and “interval”, these terms are often used interchangeably by traffic engineers.

**Cycle**—sum total of all phases at a signal

- A cycle is timed from the start of one phase to the start of that same phase when it comes around again.
- Larger, busier intersections will commonly have longer cycles.

## PRETIMED (FIXED TIME) SIGNALS

Pretimed intersections operate in predetermined and predictable fashion.

- Regularly repeated sequence of phases (often 30 seconds or more), regardless of traffic flow
- Length of phases may change at different times of day, based on a consistent timing plan, for example, one street may have longer phases at peak hours than non-peak hours
- Still found in many locations, particularly in downtown areas

## ACTUATED SIGNALS

Actuated signals change the length and/or order of the phases in response to variations in vehicle or pedestrian traffic.

- Detectors monitor traffic and send signals to the traffic signal controller. Detectors are most often inductive loops (electric), though they may be magnetic, microwave, video, and other detection technologies.
- Pushbuttons are most often used for pedestrian detection, though other “pedestrian sensing” technologies (microwave, infrared, piezoelectric) may be used as well.
- Used where traffic volumes fluctuate or where it is desirable to minimize interruptions to traffic flow on the major street. Detectors are often placed on minor roads and in turn lanes to detect when a motorist is waiting to make a turn.
- Vehicular actuation allows the cycle to skip phases, so pedestrians with visual impairments cannot accurately predict, based on previous experience, when in the cycle the pedestrian phase will begin.
- Some actuated signals may provide very short phases to accommodate a single vehicle, without provision of a pedestrian phase during that cycle. A pedestrian who is blind crossing parallel to that vehicle may not realize that a pedestrian phase is not provided during that vehicle’s movement.



**Figure 3-1. Photograph of vehicle detector loops in pavement**



**Figure 3-2. Photograph of vehicle detector loop in pavement**

The extent of actuation is dependent on geometric and operational requirements, but is generally categorized as either semi-actuated or fully actuated.

### *Semi-actuated signals*

- Common at the intersection of a main road and a minor side street
- Main roadway signal stays in green until a side street detection is received, causing the traffic signal to change (the WALK signal for the crossing the main roadway may not come on unless pedestrian pushbutton is pressed)
- Vehicle detectors only on the side street; pedestrian detectors are also possible only on the side street
- Pedestrian activation (usually use of pushbutton) activates signal to give WALK interval for pedestrian phase to cross the major street
- Pedestrian signal for side street crossing may “rest-in-WALK” (gives the WALK indication during the green signal for the major street) for the visual pedestrian signal with no pushbutton installed

### *Fully actuated signals*

- Common at the intersection of two main roads (arterials)
- All movements/ phases are actuated
- Detectors for vehicles on all approach lanes
- Pedestrian pushbuttons or detection to activate WALK signal for pedestrian crossings
- Used when traffic volumes on each approach vary by time of day
- Used to skip phases within a cycle when vehicles are not present, thus minimizing delay
- Changing traffic volume can result in difference in timing and sequence of phases for every cycle

## **BASIC TURNING PHASES**

### *Protected turn*

A protected turn is made without opposing through vehicular traffic or pedestrian crossing.

- Denoted for motorists by a green arrow
- Typically activated by a vehicle detector
- The signal phasing “protects” vehicles by prohibiting the opposing movements, including pedestrian movements
- Protected turns require a separate signal phase, which leads to multiphase signalization (more than two phases at the intersection)

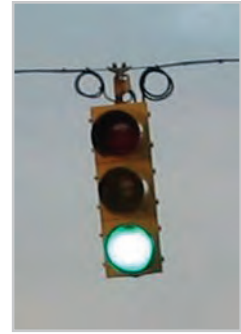


**Figure 3-3. Protected left turn signal**

## *Permissive turn*

A permissive turn is made across an opposing flow of through vehicles and/or pedestrians.

- Typically denoted for motorists by a circular green (green ball) signal
- The driver is “permitted” to cross the opposing through flow, but must select an appropriate gap in the opposing traffic stream through which to turn
- The driver must also yield to pedestrians who are crossing lawfully within the intersection
- This is the most common type of left-turn phasing at signalized intersections, and is used both when left-turn volumes are not excessive and where adequate gaps of sufficient size exist in the opposing traffic to accommodate turns safely



**Figure 3-4. Permissive green ball signal**

## **DESIGN OF TURNING MOVEMENTS**

### *Concurrent (dual) left turns*

- Two directions of turning traffic (eastbound and westbound) proceed together as the opposing through traffic on the same approaches is stopped (protected left turn phasing)
- Can be activated either before or after the opposing through flows have had their green phase. If the left turn comes before the opposing through movement, it is called a “leading left turn”. If it comes after, it is called a “lagging left turn”. Leading left turns, which are much more common than lagging left turns, can create safety problems for blind pedestrians, since the surging left turn traffic may be mistaken for the parallel through traffic surge.

### *Split or non-concurrent phasing*

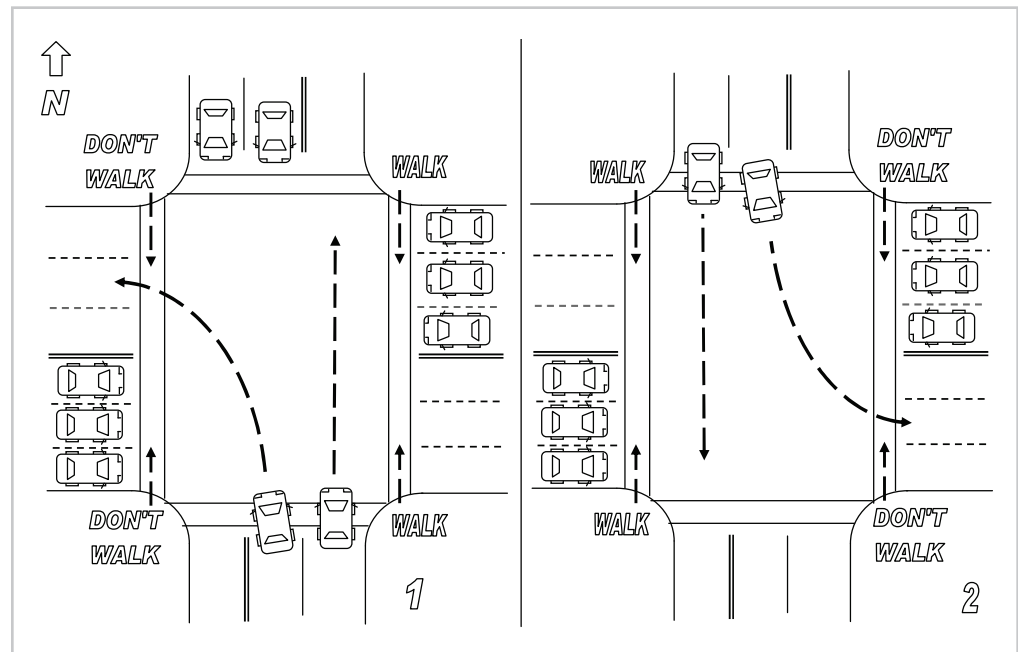
- Split phasing provides separate green time to vehicles on opposing approaches
- In typical signal design, the northbound and southbound through movements run simultaneously, as do the eastbound and westbound through movements. At offset intersections and locations where there are heavy turn movements, split phasing may be used to allow movements on each approach to move independently of other approaches.
- Pedestrian phases for parallel crosswalks will be activated at different times. The pedestrian phase for a crosswalk will coincide with the through traffic movement immediately adjacent to that crosswalk.
- Where there is split phase timing, the surge of parallel vehicles beside the pedestrian may be mistaken as indicating the onset of the WALK interval and blind pedestrians may cross into the paths of left turning vehicles. In addition, the heavy flow of turning traffic may be mistaken for the surge of traffic on the street beside the blind pedestrian, when the traffic is actually on the street the pedestrian is crossing.



Example of northbound/southbound movements running under split phasing (see Figure 3-5):

1. Northbound traffic, including traffic turning east and west, moves on one signal phase, (southbound traffic and all traffic on the E/W street have a red signal at that point). The pedestrian phase usually is provided at this time for pedestrians on the east crosswalk
2. Northbound traffic receives a red light while all southbound traffic, including turning traffic, is allowed to go. The pedestrian phase usually provided at this time is for pedestrians crossing on the west crosswalk

**Figure 3-5. Illustration of split phasing**



### FLASHING OPERATION

Signals may only operate during peak periods of the day and may switch to flashing operation at non-peak hours, late at night, or in response to a signal malfunction.

- Signals no longer operate under stop-and-go sequencing
- Signals usually flash red for side streets and flash yellow for the main street or flash red for both streets
- Pedestrian signal heads (WALK/DONT WALK signs) are dark and APS are silent

### COORDINATED SYSTEMS

Coordinated systems provide automated control of signal timing to two or more signalized intersections.

Instead of looking at an intersection in isolation, coordinated systems look at an entire arterial or network of intersections and make signal timing adjustments that

benefit (optimize) the operation of the entire system.

System changes are a result of traffic volume and travel times. Most often, a central controller (computer) provides the primary control and communicates with individual controllers located at each intersection.

Coordinated control has a number of advantages from a vehicle perspective:

- Signals can be controlled from a central traffic management center
- The detection elements of the system can be used to predict future flows within the network and adjust the signal timing proactively instead of reactively

Signals in a coordinated system can present problems for blind pedestrians:

- The green time given for vehicles on the intersecting road (not the road whose signals are coordinated) may be less than normal to fit into the timing scheme of the coordination
- This shorter time can be insufficient for pedestrians to cross the major road. Pedestrian who are blind will not know that there is insufficient time and may directly conflict with the approaching platoon of traffic on the major road. This demonstrates a need for APS at the intersection.

# Vehicular Signals and Timing

## MEANING OF SIGNALS

The use of particular traffic signal colors and symbols, and their meaning, is described in Part 4 of the *MUTCD*. Signs and pavement marking used at signalized intersections are covered in Parts 2 and 3 of the *MUTCD*, respectively.

Although this section presents basic traffic laws concerning signals, it is important to be well educated on the specific laws of the state of interest. Some laws, such as right-turn-on-red-arrow, vary from state to state. Most states provide a Drivers Handbook that presents this sort of information.

## STEADY GREEN SIGNAL

Circular green (green ball):

- Traffic, except pedestrians, may proceed straight through or turn right or left except as such prohibition signs or markings modify movement. Vehicles turning right or left shall yield the right-of-way to pedestrians lawfully within the intersection.

Green Arrow:

- Traffic may make the movement indicated by the green arrow. Opposing vehicle and pedestrian movements will be given a red signal or DONT WALK indication.

Pedestrian movement:

- Pedestrians may cross unless a green arrow indicates conflicting traffic will cross into their path or unless a pedestrian signal indicates otherwise

## STEADY YELLOW SIGNAL

- Warning that the green interval has ended and the red signal will begin.

Pedestrian movement:

- Pedestrians do not have enough time to cross and should not initiate a crossing.

## STEADY RED SIGNAL

- Traffic must stop at the stop line, before the crosswalk lines, or before the intersecting street.

#### Right turn on red:

- Unless a sign or local law prohibits right turn on red, vehicles must come to a complete stop but are allowed to then proceed with the turn if a safe gap in traffic is available.
- Turning vehicles must yield right-of-way to pedestrians and traffic already in the intersection.
- Right-turn-on-red makes it harder to determine the surge of traffic at the onset of vehicular green on the street parallel to the crossing direction. Blind travelers must wait to hear a car traveling straight across the intersection to determine that the light has changed, so they frequently are delayed in initiating crossings while they determine that parallel traffic flow has begun.

#### Left turn on red:

- This maneuver involves a left turn from a one-way street onto another one-way street on a red signal (same procedure as stated above for right turn on red). This is not allowed in some states.

#### Red arrow:

- Vehicles must stop at a stop line, before the crosswalk lines, or before the intersection. Some states allow vehicles to turn right on red after stopping.

#### Pedestrian movements:

- Pedestrians should not enter the roadway in the direction of travel controlled by a steady red signal

### **FLASHING YELLOW**

- Proceed with caution, treated like Yield sign

### **FLASHING RED**

- Stop, then go, treated like Stop sign

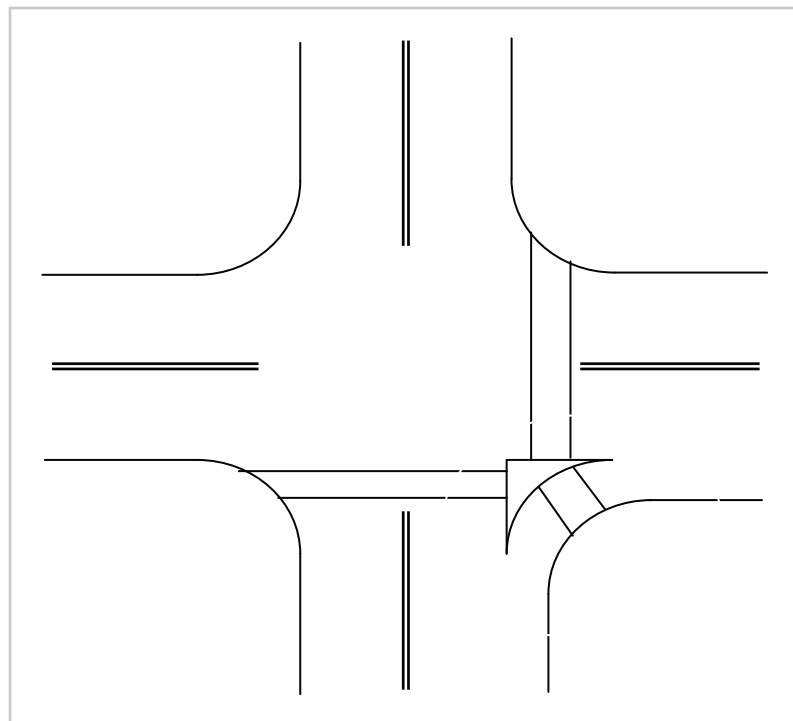
### **FLASHING RED ARROW & FLASHING YELLOW ARROW**

- Typically have the same meaning as flashing circular signal indication, except they apply only to vehicular traffic intending to make the movement indicated by the arrow.
- In some states, flashing circular yellow and yellow arrow indications may be used during stop-and-go traffic signal operations for permissive left-turn indications (same control as a green ball for left turns)
- In some states, flashing circular red and red arrow indications may be used during stop-and-go traffic signal operations for permissive left-turn indications

## OTHER INTERSECTION TERMINOLOGY

**Channelized turn lane (slip lane)**—a turn lane that channels turning drivers to a position where they will either yield to oncoming traffic or complete a “free flowing” turn, which means the turning vehicles have a dedicated lane on the road they are entering and therefore do not need to stop or yield to traffic.

**Figure 3-6. Channelized right turn lane**



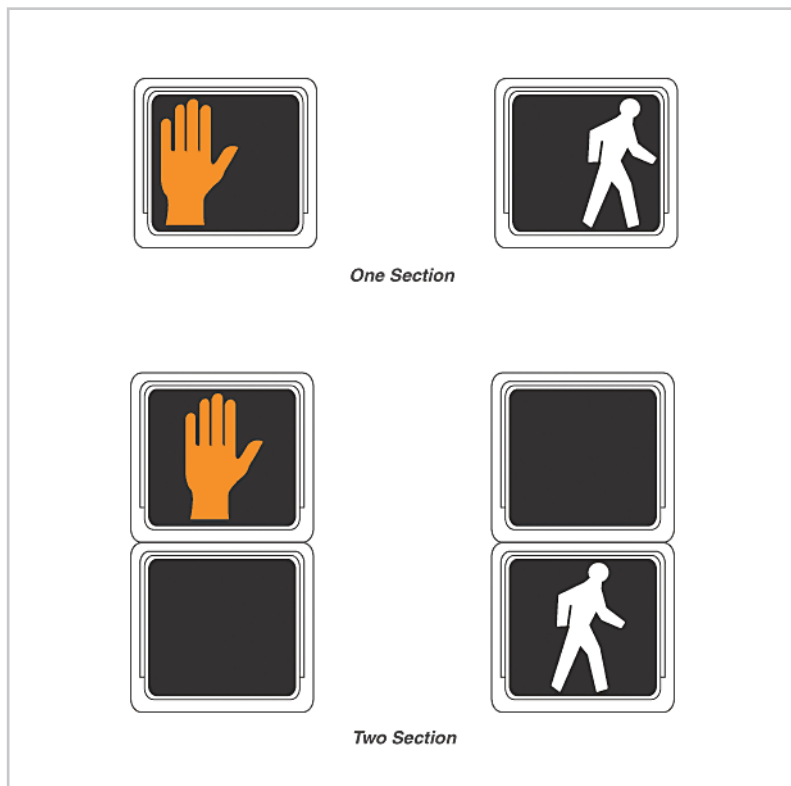
# Pedestrian Signals and Timing

## VISUAL PEDESTRIAN SIGNALS

Pedestrian signal heads (“pedheads”) are installed at some intersections to instruct pedestrians when it is lawful to cross. This is typically done where there is a significant amount of pedestrian activity or for safety-based reasons, such as the possibility of confusion for pedestrians taking cues from the traffic signal.

Pedestrian signals have three intervals:

- WALK interval—White WALK or symbol of a person walking issued to indicate that pedestrians should begin crossing, after yielding to vehicular traffic still legally in the crosswalk.
- Change interval—Orange flashing DONT WALK or symbol of a flashing hand is used when pedestrians are not supposed to begin a crossing because there is not enough time left in the phase for most pedestrians to get all the way across the street. Pedestrians that have already begun to cross should finish crossing.
- DONT WALK interval—Steady orange DONT WALK or symbol of a hand is used when pedestrians are not supposed to be in crosswalk.



**Figure 3-7. Typical pedestrian signal symbols**



**Figure 3-8. Correct display of pedestrian countdown signal (counting down during flashing DONT WALK)**

Some locations also use pedestrian countdown signals. These signals provide the countdown in seconds for the remaining time allotted during the change interval.

- Countdown signal supplements the WALK/DONT WALK signals, rather than replacing them.
- *MUTCD* guidance stipulates that the countdown should only be displayed during the flashing DONT WALK interval because of inconsistencies of the countdown during WALK at actuated signals. However, many cities are still using signals that display the countdown during the WALK interval (see Figure 3-9). Pedestrians with low vision have had problems distinguishing the countdown numbers from the orange flashing hand symbol when they are displayed alongside the white walking-man symbol.

### PEDESTRIAN SIGNAL TIMING

Pedestrian signal timing design deals with the length of the WALK and change intervals. The WALK interval is typically short (around 4 to 7 seconds). The change interval is designed to be long enough for a pedestrian to cross the street. This is typically calculated assuming a walking speed of 3.5 to 4 feet per second. Parking lanes might be excluded from the calculation.

The green time for the parallel traffic movement is calculated based on the time necessary for a pedestrian to cross the street (see equation below).

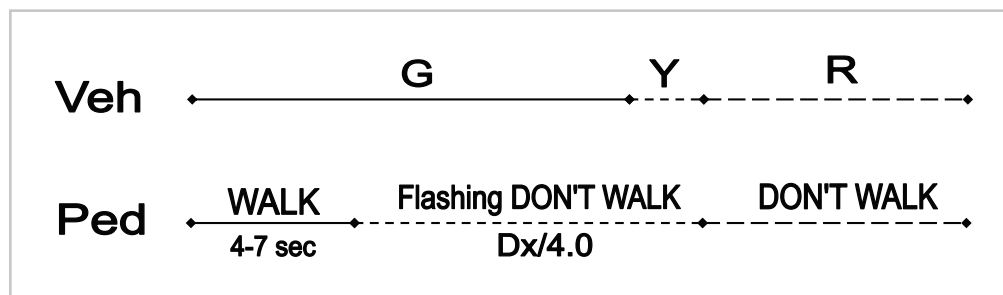


**Figure 3-9. Incorrect display because countdown is displayed during WALK interval**

$$\text{Minimum Green Time} = \text{WALK interval} + \underbrace{\frac{\text{Crosswalk Length}}{4.0 \text{ ft/sec}}}_{\text{Flashing DON'T WALK}}$$

The figure below illustrates how the vehicle and pedestrian phases overlap. Time is the horizontal axis in the picture. This is a typical signal timing diagram used by traffic engineers in the design of the signal timing.

**Figure 3-10. Illustration of the overlay of vehicle signal and pedestrian signal timing**



## PEDESTRIAN PHASE ACTUATION

Some signals are designed so that the pedestrian phase is actuated by a pushbutton.

- Pressing the pushbutton calls a pedestrian phase which allows enough time for the pedestrian to cross at average walking pace
- Without pushing the button, there may not be enough time programmed into the vehicular phase for a pedestrian to cross the street. If the button is pressed, the pedestrian phase may begin immediately or will begin at a certain point during the following cycle.
- Extent of the delay before it begins will vary depending on the programming of the phases for that intersection and when the button was pushed within the cycle.
- Blind pedestrians have traditionally waited through a light cycle to assess and refine their heading by listening to vehicular trajectories, before crossing on the next pedestrian phase. At a pedestrian-actuated intersection, that is not possible because pedestrians have to cross on the next pedestrian phase after pushing the button. If they do not cross at that time, it is necessary to locate and push the button again (and re-establish their alignment).

## PASSIVE PEDESTRIAN DETECTION

- Pedestrians may be detected passively (without pushing a button) as they approach the crosswalk area through the use of microwave, infrared or piezoelectric technologies.
- Future developments may impact whether or not an APS with a locator tone is necessary at an intersection that uses passive detection. One issue for consideration is that pedestrians may not realize they have been detected.

## LEADING PEDESTRIAN INTERVALS

- Provides a pedestrian WALK interval 2 to 4 seconds before the vehicular green, allowing pedestrians a head start so they are in the intersection before vehicles start up.
- However, this can be a disadvantage to pedestrians who are blind or visually impaired who rely on the surge of traffic to recognize when the signal is green. If these pedestrians begin crossing with the surge of parallel traffic where a leading pedestrian interval is used, they will have less time to cross than was designed. Also, when pedestrians do not initiate their crossing at the onset of the WALK interval, drivers may interpret this to mean that the pedestrians are not intending to cross.
- Pedestrians who are blind or visually impaired do not know about the leading pedestrian interval at unfamiliar intersections unless there is an APS installed.



## **EXCLUSIVE PEDESTRIAN PHASING**

- All vehicles have a red light during the WALK interval and all crosswalks have the WALK signal at the same time.
- Typically done to increase pedestrian safety. At some locations, right-turn-on-red is allowed during the pedestrian phase.
- Crossings may be made diagonally for pedestrian efficiency.
- Exclusive pedestrian phasing may be followed by an extended time for one or more of the crosswalks.
- Exclusive pedestrian phasing may be beneficial to pedestrians with mobility impairments and cognitive disabilities as it allows time to cross when no or few vehicles are moving through the intersection. However, it is a disadvantage for pedestrians who rely on traffic sounds to determine the signal phases. In addition, initial alignment and maintaining alignment during crossings may be difficult due to the absence of parallel moving traffic.

## **PED RECALL**

- WALK indication will be given every cycle (as if someone were always there pushing the button).

## **REST-IN-WALK**

- Pedestrian signal to cross the minor street remains in WALK as long as the major street has green, and there is no call on the minor street
- When a vehicle approaches on minor street and is detected, the pedestrian signal to cross the minor street changes to flashing DONT WALK
- APS during Rest-in-WALK: instead of sounding constantly, some APS manufacturers provide a limit switch that limits the length of the audible WALK indication to seven or eight seconds, but recalls the audible and vibrotactile indications of the WALK if the button is pressed when there is adequate clearance time remaining.

# Collaboration

## CONTACTING LOCAL TRANSPORTATION PROFESSIONALS

Transportation professionals may consist of traffic engineers, public works personnel, signal technicians, and/or transportation planners. In some cases, local consulting engineering firms are contracted to provide operation and maintenance control of signalized intersections. The ownership of the signal, whether it is at the township, county, city or state level, designates which transportation professional would be in charge of the intersection.

Make contact with the transportation professional by contacting your local government office. Work in a collaborative manner and develop a productive working relationship:

- Talk with the transportation professional and familiarize yourself with the procedures to accommodate your request.
- Understand that additional parties and factors may be involved when addressing your request (funding, politics, etc).
- Ask transportation professionals about signal phasing and timing plans at particular intersections and how pedestrians are accommodated.

## UNDERSTAND MUNICIPALITY STRUCTURE

Structure varies from one municipality to the next:

- Engineering may be part of public works, or it may be a separate department
- Intersection signals may be part of a state or county traffic management network, even if within a town or city, or they may be managed by a consulting firm
- New construction of an intersection may be contracted out to a traffic engineering or electrical contractor
- Signals may be maintained by a different department than the one that installed them
- Learn if there is a local jurisdiction or statewide ADA coordinator and/or a Department of Transportation/Public Works Department ADA coordinator. This coordinator may ensure that the local jurisdiction's streets, sidewalks and facilities are accessible to pedestrians with disabilities. The coordinator may also have more influence in getting traffic engineers to install accessible signals than someone outside of the local jurisdiction.

To learn about a city department structure, check the city web site or check a phone directory for offices and structure information.

## CONTACT PERSON IN TRAFFIC ENGINEERING DEPARTMENT

Call the department that manages traffic signals and ask who to talk to about a specific intersection.

- Call and explain to the transportation professional what you do and why you want to know about the intersection (people responsible for the traffic signals may not have considered all travel strategies and may not know that professionals exist to consult with about the travel needs of pedestrians with visual impairments)
- Ask the person in charge for more information about who does what and how to ask for information
- Find out the procedure for requesting changes or modifications to an intersection

## ATTEND MEETINGS

Consider attending:

- Local pedestrian advisory/advocacy meetings. Many towns set up these groups to solicit feedback on pedestrian issues and advice on potential solutions.
- Local meetings of the Institute of Transportation Engineers (ITE) or other engineering professional meetings.
- Local Disability Advisory Committee meetings. The Disability Advisory Committee reports directly to elected officials (Mayor, City Council, and County Board of Supervisors) of the local jurisdiction.

If the Disability Advisory Committee has a Physical Access Subcommittee, an O&M specialist may want to become a permanent member in order to have an opportunity to advocate for and influence future installations of accessible signals.

## PUBLIC HEARINGS

Consider attending Transportation Improvement Plan (TIP) public hearings:

- Opportunities provided to meet Department of Transportation staff and/or traffic engineers.
- Present brief comments on the needs of pedestrians.

## EDUCATE YOURSELF

Keep informed:

- Familiarize yourself with APS installations in your area or nearby areas
- Learn the language used by traffic engineers
- Familiarize yourself with state regulations and practices such as *MUTCD*, ADA Title II and *Draft PROWAG*

- Learn the desires of others in your community
- Remain informed on current APS technology
- Follow up on any requests and do not assume someone else is doing everything right
- Learn where to report problems or malfunctions

## **EDUCATE YOUR STUDENTS**

Responsibilities to students:

- Teach students about changes in signalization and intersection geometry
- Explain the necessity of using pushbuttons at actuated intersections
- Remind students that timing plans can vary, so the signal timing they identify when crossing the intersection at a specific time of day or day of week may be different the next time they use the same intersection
- Assist students in requesting an APS
- Teach students how to use APS

## **ADVOCATE FOR APS**

Advocate for APS, especially at intersections when:

- Pedestrians are unable to discern the WALK interval
- A pedestrian pushbutton controls the pedestrian crossing phase
- Signalization includes a leading pedestrian interval or an exclusive pedestrian phasing
- Many electric or hybrid vehicles are present



# Chapter 4:

## Features of APS

### CHAPTER SUMMARY

This chapter provides a description of APS features, including WALK indications. The features currently available on APS marketed in the U.S. and abroad and their use by pedestrians who are blind or who have low vision are discussed.

Intersection geometry, signalization and installation location can affect the features needed at a particular location to provide adequate unambiguous information to pedestrians who are blind or who have low vision. Poor installation can result in ambiguous WALK information from any APS. More information on designing installations and determining needed features is provided in Chapters 6 and 7.

APS technology is changing rapidly and additional choices or features may become available. Those making purchasing decisions should consider the background information provided in this chapter when evaluating new technology.

### CHAPTER CONTENTS

Criteria for WALK indications .....	49
Current recommendations for WALK indications .....	50
WALK indication—tones .....	52
WALK indication—speech messages .....	54
Vibrotactile WALK indication .....	56
Pushbutton locator tone .....	57
Tactile arrow .....	59
Automatic volume adjustment .....	61
Actuation indicator .....	63
Extended button press .....	64

Pushbutton information message .....	66
Audible beaconing .....	69
Alert tone .....	71
Tactile map .....	72
Braille signs .....	74
Raised print or large print signs .....	75
Passive pedestrian detection .....	76
Remote activation .....	77
Tones or audible messages during clearance interval .....	78
Integrated information devices .....	80

## Criteria for WALK indications

### WALK INDICATION IS CRITICAL

The WALK indication provides critical safety information. The WALK indication should be:

- Readily detectable in the presence of ambient vehicular sound
- Highly localizable
- Uniquely recognizable as a WALK signal
- Unambiguous with regard to which crosswalk has the WALK interval

### CRITERIA

In the U.S., the *MUTCD* and *Draft PROWAG* currently provide some specific criteria for WALK interval indications:

- Shall have audible and vibrotactile indications of the WALK interval. Audible indication shall be tone or speech message. (*Draft PROWAG* R306.2 Pedestrian Signals and R306.2.3 Audible WALK Indication)
- The information provided “...shall clearly indicate which pedestrian crossing is served by each device.” (*MUTCD* 4E.06)
- The audible tone(s) shall be audible from the beginning of the associated crosswalk. (*MUTCD* 4E.06)
- Volume shall be 2 minimum and 5 db maximum above ambient noise level in standard operation (*Draft PROWAG* R306.2.3.2 Volume; *MUTCD* 4E.06)
- Should be no louder than the associated pushbutton locator tone unless a louder audible beaconing feature is actuated (*MUTCD* 4E.06; *Draft PROWAG* Advisory R306.2.3.2 allows beaconing to exceed volume limits)
- If the tone for the WALK interval is similar to the pushbutton locator tone, the WALK interval tone shall have a faster repetition rate than the associated pushbutton locator tone (*MUTCD* 4E.06)

### CAREFUL APS LOCATION IS ESSENTIAL

*Draft PROWAG* requires APS to be located at the pushbutton (pushbutton-integrated) to enable use of the vibrotactile feature. **Discussion in this chapter assumes that APS are integrated into the pushbutton, unless another mounting location is specifically discussed.**

There are a number of APS available that meet the above listed criteria, however proper installation is also critical to their effective functioning. Chapter 6 discusses installation location requirements in detail.



## Current recommendations for WALK indications

### AUDIBLE AND VIBROTACTILE INDICATIONS REQUIRED

Audible (speech or tone) and vibrotactile indications of the WALK interval are required by *Draft PROWAG*.

The *MUTCD* does not currently provide specifications of audible WALK indications except cautions about the use of tones that could be confused with birds or back-up beepers.

WALK indications can be provided by use of

- Tones,
- Speech messages (also referred to as verbal messages), and/or
- Vibrating surfaces

More information about the use of each is provided on the following pages.

Recent research recommends tones at locations where the speakers for APS for two different directions can be separated. Speech messages are recommended where speakers must be located on the same pole or less than 10 feet apart.

### ASSOCIATING TONES WITH DIRECTION OF TRAVEL

In the past in the United States, audible pedestrian signals have utilized two different tones that are associated with two different crossing directions broadcast from speakers mounted at the pedestrian signal head. The most common tones used were the bird sounds, specifically “cuckoo” and “cheep”, with the cuckoo used for north/south crosswalks, and the cheep for east/west crosswalks. However, research since 1988 has documented that such a system is often ambiguous and confusing (see Appendix C, page 14).

### USING A DIFFERENT TONE FOR EACH DIRECTION OF TRAVEL IS NO LONGER RECOMMENDED IN THE U.S.

Use of a single tone for crossings in all directions

In Europe and Australia, a single tone has been used successfully for years to indicate the WALK interval from speakers located at the pedestrian pushbutton. There is some variability in the tones used. Typically, the tone for WALK is the same tone as the pushbutton locator tone, repeated at a faster repetition rate, usually about 10 times faster. The same tone is used for all crossing directions.

A single tone works because the standardized location of the pushbutton-integrated speaker in relation to the crosswalk provides information about which crosswalk

has the WALK interval. Pedestrians are beside the appropriate APS when they are waiting to cross, normally within arm's reach of the APS, and at some distance from the APS for another crosswalk. Speakers located in this manner are now included in the Access Board's *Draft PROWAG*.

See the Chapter 6 discussion of installation decisions for more about location of APS speakers and vibrotactile WALK indications.

## WALK indication – tones

### DESCRIPTION

A tone is provided during the WALK interval. The WALK indication of APS in the US has typically been provided by an audible signal such as a beep, buzz, percussive sound, or cuckoo/cheep. Current recommendations are that the tone used to indicate the WALK interval should be a ticking tone which repeats 8 to 10 times per second, otherwise known as a rapid tick. That tone is provided from the pedestrian pushbutton location.

### ADDITIONAL INFORMATION

The rapidly repeating tick tone (at least 8 times per second) has been found to result in faster response than verbal messages or a two-tone system (cuckoo/rapid tick). Errors in responding to the correct signal were also reduced by using the rapid tick tone, when two APS on a corner were separated by at least 10 feet and each was located close to the crosswalk it signaled. For information about the research on tones, see Appendix C.

The WALK indication should also have a faster repetition rate than the pushbutton locator tone; *MUTCD* specifies the repetition rate and duration of the pushbutton locator tone at once per second (see pushbutton locator tone, page 4-12).

Tones consisting of multiple frequencies, high and low, with a large component at 880 Hz have been found to be highly detectable and localizable in the presence of traffic sound. Frequencies above 1kHz are difficult for persons with age related upper-frequency hearing loss to detect. However for persons with normal hearing, the presence of multiple higher harmonics aids localization.

### WHEN TO USE

An audible WALK indication is needed on any APS.

Tone indications should be used where speakers are separated by adequate distance and located close to the crosswalk they serve, so it is clear which speaker is sounding. Generally, tone indications should be provided from pushbutton-integrated speakers, rather than from speakers mounted on pedestrian signal heads.

### REFERENCES

Currently the *MUTCD* states: “When accessible pedestrian signals have an audible tone(s), they shall have a tone for the WALK interval. The audible tone(s) shall be audible from the beginning of the associated crosswalk. If the tone for the WALK

interval is similar to the pushbutton locator tone, the WALK interval tone shall have a faster repetition rate than the associated pushbutton locator tone.” (4E.06). Revisions to standards and guidance are anticipated in the 2009 edition of the *MUTCD*.

*Draft PROWAG* provides information on tones: “R306.2.3.1 Tones. Tones shall consist of multiple frequencies with a dominant component at 880 Hz. The duration of the tone shall be 0.15 s. and shall repeat at intervals of 0.15 s..”

It is expected that *Draft PROWAG* and *MUTCD* will be harmonized during upcoming revisions.

Research has been completed on detectability and localizability of tones and use of two different tones versus a single tone. See Appendix C for more information.

## **HOW USED BY PEDESTRIANS WHO ARE BLIND OR WHO HAVE LOW VISION**

The audible WALK indication provides a clear cue to the beginning of the pedestrian phase. Pedestrians will evaluate traffic and the intersection, then listen for the WALK indication. After hearing the WALK indication, they typically check that traffic has stopped and no cars are turning across their path before beginning their crossing.

## WALK indication – speech messages

### DESCRIPTION

A speech message is provided during the WALK interval, usually from a speaker located at the pushbutton.

The message should follow the recommended model: “Maple, WALK sign is on to cross Maple.” The recommended message for an intersection with an exclusive pedestrian phase is “WALK sign is on for all crossings.”

### ADDITIONAL INFORMATION

The speech WALK message must be detectable, localizable, recognizable, and must also be correctly understood by all users. Speech messages from pushbutton-integrated APS seem very user-friendly and have become popular in the U.S. market. However, the words and their meaning must be correctly understood by all users in the context of the street environment where they are used.

Use of speech messages will not automatically solve all ambiguity problems. In even moderate traffic conditions people who have age-related or other hearing losses, people who are not native English speakers, and people with cognitive disabilities are likely to miss hearing or to misunderstand some words, possibly resulting in misunderstanding entire messages.

Model messages have been determined through research (see page 4-8 and Appendix C). Recommendations for word order and wording of the model messages should be strictly followed. Where complete sentences are used in the models, they should be used in actual messages for the same situations. In the model messages, such words as street, avenue and road are not used, however in some locations, they may be needed to avoid ambiguity.

Pedestrians have to know the names of streets they are crossing in order for speech WALK messages to be unambiguous. In getting directions to travel to a new location, travelers do not always get the name of each street to be crossed. They may only know that they have to cross four streets before looking for their destination. Therefore, the APS has to give the user the name of the street controlled by the pushbutton. This can be done by means of a pushbutton information message during the flashing or steady DONT WALK intervals. See page 4-8 for a description of pushbutton information messages and recommended message wording.

The user must then combine the information from the pushbutton information message or Braille label, the tactile arrow, and the speech WALK message in order to correctly respond to the speech WALK message. Information from all may be necessary to correctly identify the street and crossing interval at an unfamiliar

intersection. This complex process is much more cognitively demanding, and more liable to result in errors or delay than the use of a tone from a speaker located right beside the crosswalk.

A speech and tone WALK indication may be combined (i.e. “Maple, WALK sign is on to cross Maple”) followed by rapid tick for the rest of the WALK interval.

## WHEN TO USE

An audible WALK indication is needed on any APS. Speech WALK messages are recommended only where pushbutton speakers must be located on the same pole, or less than 10 feet apart.

## REFERENCES

*Draft PROWAG* allows the WALK indication to be provided by speech messages but does not provide additional specifications. (R306.2.3)

*MUTCD 2003* provides minimal information regarding speech WALK messages. It states that: “When verbal messages are used to communicate the pedestrian interval, they shall provide a clear message that the WALK interval is in effect, as well as to which crossing it applies. The verbal message that is provided at regular intervals throughout the timing of the WALK interval shall be the term “WALK sign,” which may be followed by the name of the street to be crossed. (*MUTCD 4E.06*)”

Revisions and additional language have been approved by the National Committee on Uniform Traffic Control Devices and recommended for inclusion in the 2009 *MUTCD*. These revisions incorporate recommended messages.

Recent research evaluated localizability and detectability of speech messages, developed recommended message wording, and determined that response to speech messages was more accurate than responses to two different tones, when pushbuttons were on the same pole (see Appendix C, page 16).

## HOW USED BY PEDESTRIANS WHO ARE BLIND OR WHO HAVE LOW VISION

The audible WALK indication provides a clear cue to the beginning of the pedestrian phase. Pedestrians who are blind or who have low vision will evaluate traffic and the intersection, then listen for the WALK indication. After hearing the WALK indication, they typically check that traffic has stopped and no cars are turning across their path before beginning their crossing.

## Vibrotactile WALK indication



**Figure 4-1. Pedestrian waiting to feel the vibrotactile WALK indication**

### DESCRIPTION

The pushbutton or a raised arrow on the APS housing vibrates during the WALK interval.

### ADDITIONAL INFORMATION

Vibrotactile information is useful when pedestrians can be aligned and prepared for crossing while still keeping a hand on the APS.

Those who are deaf or hard of hearing must also know where to find the device since the pushbutton locator tone is not helpful.

### WHEN TO USE

The vibrotactile indication of the WALK interval is needed at most locations and is required by *Draft PROWAG*. However, it is useful only when the device is located close to the crossing departure location.

It is important to note that *Draft PROWAG* requires audible information in addition to vibrotactile indications of the WALK. Without specific training on the device, blind pedestrians may not find or use the vibrotactile indication, particularly if it is not located on the actual pushbutton.

### REFERENCES

*MUTCD* standard states that: “Vibrotactile pedestrian devices, where used, shall indicate that the WALK interval is in effect, and for which direction it applies, through the use of a vibrating directional arrow or some other means.” Guidance states that the devices should be adjacent to the intended crosswalk. (*MUTCD* 4E.06)

*Draft PROWAG* (R306.2) requires a vibrotactile indication of the WALK interval at each crosswalk with pedestrian signal indications.

### HOW USED BY PEDESTRIANS WHO ARE BLIND OR WHO HAVE LOW VISION

Pedestrians will stand beside the pushbutton with their hand on the vibrating arrow while waiting to cross. The vibrotactile indication communicates to pedestrians who are deaf-blind that the WALK interval is in effect and may provide confirmation of the WALK interval to pedestrians who are blind at a particularly noisy intersection.

## Pushbutton locator tone

### DESCRIPTION

A pushbutton locator tone is “A repeating sound that informs approaching pedestrians that they are required to push a button to actuate pedestrian timing and that enables pedestrians who have visual disabilities to locate the pushbutton.” (*MUTCD* 2003, 4E.09)

The pushbutton locator tone is referred to by different names in manufacturer’s brochures, including:

- pole locator
- locator signal
- locator tone
- locating tone
- locator audible

### ADDITIONAL INFORMATION

Pushbutton locator tones typically sound from the pushbutton during the flashing and steady DONT WALK intervals. The locator tone informs pedestrians of the need to push a button and provides an audible cue to the location of the pushbutton. During the street crossing the locator tone may be audible in the last lane and provide a cue to the direction of the destination.

In available products, the pushbutton locator tone varies from a click sound to a beep tone. Repetition rate and length of tone are standardized by language in the *MUTCD*: “...pushbutton locator tones shall be easily locatable, shall have a duration of 0.15 seconds or less, and shall repeat at 1-second intervals.” (4E.09)

Volume of this slowly repeating tone should be adjusted to be heard **no more than 6 to 12 feet (2 to 4 meters) from the push button or at the building line, whichever is less** (*MUTCD* 4E.09). *Draft PROWAG* states that the volume of the pushbutton locator tone is to be adjusted to between 2dB and 5dB above ambient sound levels in standard operation. (R306.3.2) These requirements may appear to be in conflict, however both can generally be met. Perceived loudness can vary, depending on the environment near the sound source.

Both *MUTCD* and *Draft PROWAG* allow an increased volume of the locator tone to provide audible beaconing in response to a request (see sections on extended button press and audible beaconing).

The pushbutton locator tone typically has automatic volume control. A microphone or sensing device is installed in the APS device or in the pedestrian signal head to monitor intersection sound levels and adjust the volume of the locator tone. This



technology is also used to adjust the volume of the WALK indication. The web page at [www.walkinginfo.org/aps](http://www.walkinginfo.org/aps) includes sample locator tones.

## WHEN TO USE

The pushbutton locator tone can be useful whenever there is a pushbutton that a pedestrian should use.

## REFERENCES

*Draft PROWAG* requires a pushbutton locator tone wherever there is a pushbutton (R306.3.2).

*MUTCD* states that pushbutton locator tones may be used. (4E.09).

*Draft PROWAG* and *MUTCD* have additional information regarding pushbutton locator tone volume, as discussed above.

How used by pedestrians who are blind or who have low vision

Pedestrians who are unfamiliar with an intersection will approach the intersection:

- Upon hearing the locator tone, or two locator tones if there are two pushbuttons, will realize that there is a pushbutton for the crossing,
- Will probably continue to the curb or curb ramp location, in order to become familiar with the corner, determine proper alignment, and become familiar with the intersection layout and sounds by listening to traffic,
- Return to the pushbutton locator tone that is believed to be the correct pushbutton for the crossing, if it is not within reach, and check that the tactile arrow alignment is parallel to the desired crosswalk,
- Push the button and return to the curb to realign to cross the intersection, if necessary,
- May repeat this process if the pedestrian phase begins before they are properly aligned to cross.
- While crossing the street, the pushbutton locator tone for the APS on the opposite side of the street may be audible, allowing them to home in on the sound.

## Tactile arrow

### DESCRIPTION

A raised (tactile) arrow may be part of the pushbutton as seen in Figure 4-2, above the pushbutton (Figure 4-3) or on top of the device (Fig 4-4) and is used to communicate to pedestrians which crosswalk is controlled by the pushbutton. The tactile arrow provides confirmation that is similar to the printed sign and arrow which are commonly provided for pedestrians who are sighted.

The arrow should contrast with its background. On most APS, this arrow also vibrates during the WALK interval.

### ADDITIONAL INFORMATION

It is important that the arrow points in the direction of travel on the crosswalk, as it indicates which crosswalk is controlled by that pushbutton. Tactile arrows provide general alignment information for all pedestrians. However, it is important to note that tactile arrows do not seem to enable the extremely accurate alignment required for blind and visually impaired pedestrians. To align the arrow properly, the installer needs to understand that pedestrians are expecting the arrow to be aligned toward the destination across the street. The purpose is not to point toward the beginning of the crosswalk, or the curb ramp location. Misalignment of the arrow may direct a blind pedestrian into the center of the intersection.

For arrows on the face of the device, the alignment is determined by the installation of the pushbutton on the pole. Arrows on the top of the pushbutton housing are typically glued into place after the pushbutton is installed and their alignment can be adjusted separately from the pushbutton.



**Figure 4-2. This APS has a high-contrast, raised tactile arrow on the pushbutton and a high-contrast, recessed tactile arrow on the sign above the button**

**Figure 4-3.** The tactile arrow above the pushbutton on this APS is superimposed on a larger visual arrow



**Figure 4-4.** The tactile arrow is located on top of this APS housing (note the lack of necessary color contrast between the arrow and housing)



## WHEN TO USE

Tactile arrows are recommended at all locations with an APS.

## REFERENCES

Pushbuttons and arrows should be within 5 feet of the extended crosswalk lines, (*MUTCD 4E.09*), and aligned in the direction of pedestrian travel controlled by the pushbutton (*MUTCD 4E.09*; *Draft PROWAG R306.4.1*).

Arrows should have good visual contrast with their background so that all users, including those with low vision, may see them readily (*MUTCD 4E.09*, *Draft PROWAG R306.4.1*).

*Draft PROWAG (306.4.1)* provides specifications for the arrow: “...include a tactile arrow aligned parallel to the crosswalk direction. The arrow shall be raised 0.8 mm (.03 inch) minimum and shall be 4 mm (1.5 in) minimum in length. The arrowhead shall be open at 45 degrees to the shaft and shall be 33 percent of the length of the shaft. Stroke width shall be 10 percent minimum and 15 percent maximum of arrow length. The arrow shall contrast with the background.”

How used by pedestrians who are blind or who have low vision

Pedestrians who are blind use tactile arrows to determine and confirm which crosswalk the pushbutton controls and the general direction of travel. Other clues from traffic sounds are also used to confirm alignment and crossing direction.

Blind pedestrians typically proceed in as straight a line as possible from the pushbutton to the curb of the perpendicular street in the direction of the arrow. This means that the APS should be within or as close as possible to the crosswalk lines.

# Automatic volume adjustment

## DESCRIPTION

Automatic volume adjustment is a term for volume control that is automatically responsive to ambient (background) sound.

- A louder signal is produced when vehicle and other noise at an intersection is high (as during traffic surge or when a truck is passing).
- A quieter sound is produced when background noise volume is lower (as during night-time hours or lull in traffic).
- A microphone continuously samples the noise levels and varies the volume in response to the existing sound levels. The microphone may be incorporated into the pushbutton housing, or located at the pedestrian signal head.

Automatic volume adjustment is also known as automatic gain control (AGC) or ambient sound adjustment.

## ADDITIONAL INFORMATION

Some signals can be pre-set to vary volume within particular ranges.

Most signals with automatic volume control have a minimum limit placed at about 30 dB and a maximum limit at about 90 dB.

Some APS allow the installer to set the range of the locator tone and the WALK indication separately; others have one setting for both.

A signal that is 2-5 dB above ambient sound, as perceived at the departure curb, is loud enough to be heard by pedestrians waiting at that location. If the microphone is installed at the pedestrian signal head that is set back from the curb, the traffic volume sensed by the microphone is not as loud as that perceived by pedestrians waiting at the curb. Therefore, at each installation, the setting may need to be adjusted, depending on the location of the microphone in relation to pedestrians waiting to cross.

Some APS have adjustments for microphone sensitivity as well as WALK indication and pushbutton locator tone volume.

## WHEN TO USE

Automatic volume adjustment is recommended at all locations with APS.

## REFERENCES

*MUTCD* 4E.06: “Automatic volume adjustment in response to ambient traffic sound level should be provided up to a maximum volume of 89 dBA. Where automatic volume adjustment is used, tones should be no more than 5 dBA louder than ambient sound.”

*Draft PROWAG* R306.3.2 and R306.2.3.2 requires devices to be responsive to ambient sound.

## HOW USED BY PEDESTRIANS WHO ARE BLIND OR WHO HAVE LOW VISION

Automatic volume adjustment provides flexibility and allows APS to adjust so they are not disturbing to neighbors at night or times of low traffic volume. This is also helpful to blind or visually impaired pedestrians, as the APS does not drown out essential traffic sounds necessary for crossing.

## Actuation indicator

### DESCRIPTION

An actuation indicator is a light, a tone, a voice message, or a combination of audible and visual indicators that informs pedestrians that the button has been pressed and that their desire to cross has been communicated to the controller.

Audible indicators include a click, beep, or the word ‘wait’ when the pushbutton is pushed.

### ADDITIONAL INFORMATION

If there is a light, it is at or near the pushbutton and remains illuminated until the WALK interval begins. The light is dark during the WALK and flashing DONT WALK intervals. A light may be helpful to persons with low vision, but persons who are blind require a tone.

### WHEN TO USE

An audible indication is particularly useful to pedestrians who are blind when the pushbutton is a pressure-sensitive electromagnetic button which does not feel like it depresses.

### REFERENCES

*MUTCD* 4E.08 refers to a pilot light and specifies that the “pilot light or other means of indication installed with a pedestrian pushbutton shall not be illuminated until actuation. Once it is actuated, it shall remain illuminated until the pedestrian’s green or WALKING PERSON (symbolizing WALK) signal indication is displayed.”

Activation indicators are not mentioned in *Draft PROWAG*.

### HOW USED BY PEDESTRIANS WHO ARE BLIND OR WHO HAVE LOW VISION

The indicator assures all pedestrians that the device is working, thereby encouraging pedestrians to wait until the onset of the WALK interval.



**Figure 4-5. A red actuation light is near located just above and to the left of the pushbutton**



**Figure 4-6. A red actuation indicator light is illuminated directly above the pushbutton**

## Extended button press

### DESCRIPTION

Extended button press is an option that actuates additional accessibility features. To activate the features, the pushbutton must be pushed and held for more than one second.

Other names for this feature in manufacturers' literature include:

- BAT—Button actuated timer
- Extended push

### ADDITIONAL INFORMATION

Possible features called by the extended button press include:

- pushbutton information message;
- audible beaconing; and,
- an extended crossing time.

Any or all of these features would be called by pressing and holding the same button that is used by all pedestrians.

Recent research (see Appendix C, page 27) has standardized the length of the button press at one second or longer. Some devices have previously been installed with a three-second press, but one second has been found to be adequate.

### WHEN TO USE

Extended button press should be used whenever there are optional additional features provided at a crossing that should be available on 'request'.

### REFERENCES

*Draft PROWAG R306.3.4* Optional Features permits an extended button press to activate additional features.

*MUTCD* states that "The audible tone(s) may be made louder (up to a maximum of 89 dBA) by holding down the pushbutton for a minimum of 3 seconds."(4E.09) Draft language changing the minimum length to one second has been approved by the NCUTCD, and is expected to appear in the 2009 revision of the *MUTCD*.

## **HOW USED BY PEDESTRIANS WHO ARE BLIND OR WHO HAVE LOW VISION**

Use will depend on the feature(s) called by the extended button press. See the section on audible beaconing, and pushbutton information message for further discussion of the use of those features. The intent is to allow individuals who are blind to have some choice in the use of the accessible features and to provide the optional features upon request by a person who is blind.

As the extended button press feature is more commonly installed, it would be expected that pedestrians who are blind or visually impaired might hold the button longer at unfamiliar intersections in order to determine what features are installed and decide how they want to cross the street.

The extended button press allows for installation of additional features which could be annoying or irritating to neighbors, that are activated only occasionally rather than every time the button is pressed. For example, individuals who are unfamiliar with an intersection can get intersection street name information (the pushbutton information message), but the message is not played every time the button is pressed. In addition, pedestrians can decide if they want all the possible accessible features at an intersection. For example, pedestrians may want to use audible beaconing only at certain times and with certain traffic patterns.



## Pushbutton information message

### DESCRIPTION

A pushbutton information message is a recorded message that provides the name of the street and intersection with which that pushbutton is associated. It can also provide other information about the intersection signalization or geometry.

Manufacturers refer to this feature by different names, including:

- Voice on location
- Informational message
- Verbal message
- Additional message
- Instructional/location message

### ADDITIONAL INFORMATION

The pushbutton information message is provided from a speaker located at the pushbutton, during the flashing and steady DONT WALK intervals only. The message is intended to be audible when standing at the pushbutton location. Pedestrians may be required to press the pushbutton for more than one second (see extended button press) to access the additional verbal message.

The pushbutton information message, in conjunction with the tactile arrow, can clarify street names and the crosswalk controlled and signaled by the device. This is particularly important if speech WALK messages are used. To be effective, the pushbutton information message must indicate which street is actuated by the pushbutton, and the arrow must point in the direction of travel on the described crosswalk.

A message that includes only the intersection street names, without clarifying which street is actuated by the pushbutton, provides ambiguous information. See recommendations, below, for pushbutton message wording.

A combination of information formats, raised characters, Braille, and audible information, will accommodate the most users.

### MESSAGE WORDING

Pushbutton information messages should be developed according to the following models (Bentzen et al. 2002). See additional information in Appendix C.

- Model pushbutton message: “Wait to cross Howard at Grand.”

- Model pushbutton message for intersections having an exclusive pedestrian phase with right turns-on-red prohibited: “Wait to cross Howard at Grand. Wait for red light for all vehicles”
- Model pushbutton message for intersections having an exclusive pedestrian phase with right turns-on-red permitted: “Wait to cross Howard at Grand. Wait for red light for all vehicles. Right turn on red permitted.”
- Model pushbutton message for angled crosswalks: “Wait to cross Howard at Grand. Crosswalk angles right.”
- Model pushbutton message for crosswalks to medians where a second button push is required: “Wait to cross Howard at Grand. Short WALK phase. Raised [or cut-through] median with second pushbutton.”
- Model pushbutton message for signalized crosswalks to splitter islands: “Wait to cross right turn lane to island for Howard and Grand crosswalks.”
- Model pushbutton message for crosswalks at “T” intersections: “Wait to cross Howard at Grand.” (Not different from standard intersection identification message.)

Use “Street,” “Avenue,” etc., where needed, to avoid ambiguity.

Keep the word order illustrated in the above model messages.

Some model messages have complete sentences for best comprehension.

## WHEN TO USE

Pushbutton information messages are necessary where speech WALK messages are used. If pedestrians do not know the name of the street they are crossing, the speech WALK message does not clarify which street is being signaled.

A pushbutton information message can be helpful in providing location information on demand to pedestrians who are blind or who have low vision.

## REFERENCES

The *MUTCD* states that “pushbuttons should clearly indicate which crosswalk signal is actuated by each pushbutton”. (*MUTCD* 4E.08).

*Draft PROWAG* R306.4.2 requires APS to include street name information in Braille or audible format. Pushbutton information messages can provide information about the street name.

An APS pushbutton should not be used for landmark information or to inform pedestrians with visual impairments about detours or temporary traffic control, according to recent research (Bentzen et al. 2002).

## **HOW USED BY PEDESTRIANS WHO ARE BLIND OR WHO HAVE LOW VISION**

Pedestrians who are unfamiliar with an intersection, or who wish to confirm their location, will:

- Locate and depress the pushbutton for one second or more
- Stand beside the pushbutton speaker to listen to the pushbutton information message
- Push the button again, if desired, to hear the message repeated

At a location with two pushbuttons on the same pole and speech WALK messages, it is particularly important that users understand and recognize the street name.

# Audible beaconing

## DESCRIPTION

Audible beaconing is the use of an audible signal in such a way that blind pedestrians can home in on the signal coming from the target corner as they cross the street.

The PROWAAC report, *Building a True Community* defined an audible beacon as: “a permanently fixed source emitting sound for directional orientation” (PROWAAC 2001). *MUTCD* and *Draft PROWAG* recommendations are that the beaconing be called up by special actuation, rather than the APS functioning in the louder mode all the time.

The recommended form of special actuation is an extended button press (holding the pushbutton in for over one second).

## ADDITIONAL INFORMATION

A minority of crosswalks require audible beaconing, in which the sound source provides directional orientation. Where audible beaconing is activated, the volume of the WALK indication and the subsequent locator tone during the called pedestrian phase is increased and may be operated in one of the following ways:

- Increased sound comes from all speakers for the crossing, or
- a louder locator tone comes from the speaker at the far end of the crosswalk during the pedestrian phase, or
- the louder audible WALK indication and louder locator tone are broadcast from an additional pedhead mounted speaker aimed at the center of the crosswalk, or
- the audible WALK indication alternates back and forth from speakers at each end of the crosswalk.

Audible beaconing speakers must be oriented in line with the relevant crosswalk.

- If the speaker is not carefully oriented, the signal may give ambiguous information about which street has the WALK interval, and ambiguous information for traveling straight across the street.
- Beaconing is enhanced by the presence of a locator tone that users can home in on as they approach the destination corner, island or median having an accessible pushbutton.

See Chapter 6, *Designing Installations*, for additional recommendations regarding audible beaconing.

## REFERENCE

*Draft PROWAG* does not specifically mention audible beaconing, but provides for optional features in 1106.3.4.

*MUTCD* 4E.09 (2003) states: “The audible tone(s) may be made louder (up to a maximum of 89 dBA) by holding down the pushbutton for a minimum of 3 seconds. The louder audible tone(s) may also alternate back and forth across the crosswalk, thus providing optimal directional information.”

Revisions have been made in meetings of NCUTCD and are expected to be included in the 2009 revision of the *MUTCD*. Recommendations are that the beaconing be called up by special actuation, rather than the APS functioning in the louder mode all the time. The recommended form of special actuation is an extended button press (holding the pushbutton in for over one second).

## WHEN TO USE

Not all crosswalks at an intersection need beaconing. Audible beaconing can actually cause confusion if used at all crosswalks at some intersections. Audible beaconing is probably not appropriate at locations with channelized turns or split phasing, due to the possibility of the signal being heard at the wrong crosswalk.

Audible beaconing should only be considered at:

- Crosswalks longer than 70 feet, unless they are divided by a median that has another APS with a locator tone
- Crosswalks that are skewed
- Intersections with irregular geometry such as five or more legs
- Crosswalks where audible beaconing is requested by an individual with visual disabilities
- Other locations where a study indicates audible beaconing would be beneficial

## HOW USED BY PEDESTRIANS WHO ARE BLIND OR WHO HAVE LOW VISION

Pedestrians may be able to home in on the signal to assist with maintaining alignment while crossing the street.

# Alert tone

## DESCRIPTION

An alert tone is a very brief burst of high frequency sound at the beginning of the audible WALK indication, which rapidly decays to the frequency of the WALK tone. It is intended to alert pedestrians to the beginning of the WALK interval.

## ADDITIONAL INFORMATION

An alert tone may be useful if the WALK tone is not easily audible in some traffic conditions. As used in Australia, the alert tone is 14dB above the ambient sound level.

Australian engineers believe the alert tone encourages faster initiation of crossing, which decreases the likelihood of a conflict between pedestrians and turning vehicles. Also, when crossings are initiated faster, pedestrians clear the intersection faster.

## WHEN TO USE

An alert tone may be particularly helpful in locations with high ambient noise levels to alert pedestrians to the start of a speech WALK message, or to a tone WALK indication if it is hard to hear over traffic sound.

## REFERENCE

Not mentioned in *Draft PROWAG* or the *MUTCD*.

How used by pedestrians who are blind or who have low vision

The alert tone gets the attention of pedestrians at the beginning of the WALK indication.

## Tactile map

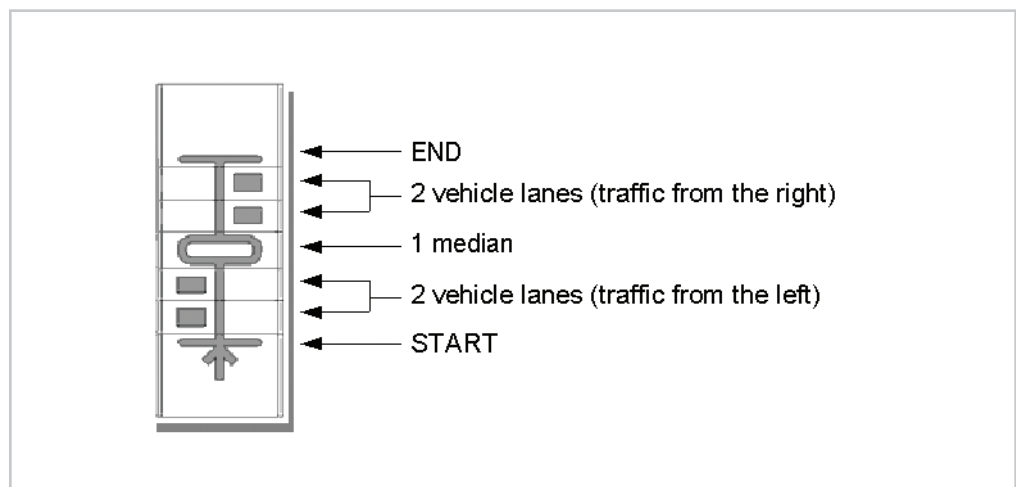
### DESCRIPTION

A raised schematic map showing what will be encountered as the pedestrian negotiates the crosswalk controlled by that pushbutton. This feature is available from one manufacturer.

### ADDITIONAL INFORMATION

Map information may include:

- Number of lanes to be crossed
- Whether the lanes are vehicular or bicycle lanes or trolley tracks
- Which direction traffic will be coming from in each lane
- Whether there is a median



**Figure 4-7.** This tactile map from a Swedish APS is read from the bottom to the top and indicates lanes as they would be encountered by pedestrians

Each map is made up of changeable ‘slugs’ inserted into the side of the pushbutton housing. It must be set up for each crosswalk of an intersection. The map information is for the crosswalk controlled by that signal only, rather than the entire intersection.

Symbols used are not standardized in the U.S., but one manufacturer has developed a standard set that is used in other countries.

## **WHEN TO USE**

A map of the crosswalk may be particularly useful at intersections with medians or islands.

## **REFERENCES**

*Draft PROWAG* states that ‘where provided, graphic indication of the crosswalk shall be tactile’. (R306.4.3)

## **HOW USED BY PEDESTRIANS WHO ARE BLIND OR WHO HAVE LOW VISION**

Pedestrians unfamiliar with the intersection or crossing hear the locator tone and locate the pushbutton and map. Standing facing the crossing, they ‘read’ the map and learn how wide the street is, and what they will encounter in the crosswalk, before they begin to cross. The map also indicates whether the pedestrian signal controlled by that pushbutton provides a crossing time for the entire crossing or just to a median or island because if the signal is just for a portion of the street, the map will show the crossing ending on a ‘median’ graphic, indicating that there is another crossing, either controlled or uncontrolled.



## Braille signs

### DESCRIPTION

Braille signs should state the name of the street that the pushbutton controls on the sign above the pushbutton housing.

**Figure 4-8. A Braille street name is pictured on a sign above the pushbutton. The street name is also provided in high contrast large print (but not raised print) at this location**



### ADDITIONAL INFORMATION

Although this may be helpful to some pedestrians who are blind, many may not locate the sign and the braille without orientation to the device.

Many individuals who are blind do not read Braille, however, those who do would prefer Braille information to confirm which street is controlled by the pushbutton

The street name on a device should be the name of the street whose crosswalk is controlled by the pushbutton.

A combination of information formats, raised characters, Braille, and audible information, will accommodate the most users.

### REFERENCES

The *MUTCD* 4E.08 states: “Name of the street ...may also be provided in accessible format...”

*Draft PROWAG* requires street name information in Braille or in an audible format. (R306.4.2)

### HOW USED BY PEDESTRIANS WHO ARE BLIND OR WHO HAVE LOW VISION

A pedestrian who is familiar with the installation of Braille but unfamiliar with a particular intersection would search the provided sign for Braille in order to learn or confirm the name of the street that is controlled by the pushbutton.

Braille signs may be helpful to individuals who are deaf-blind and who would not benefit from audible pushbutton information messages.

## Raised print or large print signs

### DESCRIPTION

The name of the street that the pushbutton controls is printed in high contrast raised print or large print on the sign above the pushbutton housing or on the pole.

### ADDITIONAL INFORMATION

Some individuals who do not read Braille may be able to read large print, or raised print. However, raised print must be large enough to be read with fingertips. Imprinting the street name in the area available can be problematic.

The street name on a device should be the name of the street whose crosswalk is controlled by the pushbutton.



**Figure 4-9. Example from Australia; a sign with raised print and Braille is mounted vertically on a round pole to the right of an APS. The sign reads “GEORGE ST. 275-339R”.**

A combination of information formats, raised characters, Braille, and audible information, will accommodate the most users.

### WHEN TO USE

Raised print signs may be particularly useful in area with large numbers of senior citizens.

### REFERENCES

*MUTCD* 4E.08 states: “Name of the street ...may also be provided in accessible format....”

*Draft PROWAG* R409.2 provides specifications for raised characters on signs. However, at this time, directional information and signs are only required to comply with 409.3 (Braille) or provide street name information in audible format.

### HOW USED BY PEDESTRIANS WHO ARE BLIND OR WHO HAVE LOW VISION

A pedestrian who is familiar with the installation of raised or large print but unfamiliar with the particular intersection would search the sign to learn or confirm the name of the street that is controlled by the pushbutton.

## Passive pedestrian detection

### DESCRIPTION

Passive pedestrian detection is sometimes used to call the pedestrian phase and can extend the clearance interval. The authors are not aware of U.S. installations of passive detection that include audible signals as well as visual signals, but the combination of passive pedestrian detection and audible signals is being used in the United Kingdom, Australia, New Zealand and the Netherlands.

One available APS provides the option of triggering the pushbutton locator tone through sensors (piezo-electric, infrared, or microwave) when a pedestrian enters the detection zone. If a pedestrian is not detected, the locator tone is silent.

### ADDITIONAL INFORMATION

An example of passive pedestrian detection technology is the “Pedestrian User-Friendly Intelligent (PUFFIN) crossing in use in England since 1993 (Department of Transport, 1993). PUFFIN crossings employ pedestrian detectors for both the pedestrian waiting area and the crosswalk. Waiting area detectors consist of either pressure mats with piezo-electric sensors, infrared or microwave detectors mounted on the signal pole, or video cameras serving remote sensor software.

### REFERENCES

*MUTCD* 4E.09 “Accessible pedestrian signal detectors may be pushbuttons or passive detection devices.”



**Figure 4-10. Detail of APS at midblock crossing in Australia. Sign reads “Push button then wait on red mat.”**



**Figure 4-11. This midblock crossing has sensors in a specific area of the sidewalk. A red mat area is labeled “Push button then wait here.”**

### HOW USED BY PEDESTRIANS WHO ARE BLIND OR WHO HAVE LOW VISION

While passive detection of pedestrians for activating the locator tone may be helpful in reducing noise near the intersections, pedestrians who are blind may not be approaching the crosswalk or intersection within the detection zone. They also may not know about it unless they are familiar with the intersection.

Pedestrians who are blind may also not stand or travel in the exact waiting or crossing area to trigger passive detection for the WALK or to extend the clearance interval.

## Remote activation

### DESCRIPTION

At least one manufacturer offers the option of a handheld pushbutton that sends a message to the APS to call the pedestrian phase. It operates on a limited range radio frequency (such as a garage door opener or car door unlocking device) within 100 feet.

### ADDITIONAL INFORMATION

Manufacturer's information does not clarify how the device would differentiate between locations at the intersection, or if using the device would place a pedestrian call for all crossings of the intersection.

### REFERENCE

Not mentioned in *MUTCD* or *Draft PROWAG*.

### HOW USED BY PEDESTRIANS WHO ARE BLIND OR WHO HAVE LOW VISION

Pedestrians could place a pedestrian call as they approach the intersection, without having to travel to the pushbutton location. This would make it unnecessary to deviate from the travel path and may be particularly advantageous for wheelchair users.

## Tones or audible messages during clearance interval

### DESCRIPTION

A tone or other message sounds during the pedestrian clearance interval, at a different rate, tone, or with a different speech message, than the WALK indication or pushbutton locator tone. This can include audible pedestrian countdowns.

APS typically revert to the pushbutton locator tone during the flashing and steady DONT WALK interval. That is not considered to be a clearance interval indication/tone.

### ADDITIONAL INFORMATION

Clearance interval information is sometimes provided by APS in Japan and in some parts of Canada.

- In Japan, a variety of alternatives are available including a European emergency vehicle “ba-boo” sound, and various melodies.
- In Canada, it may be provided by a tone that repeats at a faster rate than the WALK signal. For example, if the WALK signal is a “cuckoo” at 1 time per second, during the clearance interval the “cuckoo” is sounded 2 times per second.

Advantages:

- Lets pedestrians who are visually impaired who have begun to cross the street know that the clearance interval prevails.

Disadvantages:

- The clearance interval sound might be mistaken for the WALK signal by someone who approaches during the clearance interval, leading them to begin crossing during the flashing DONT WALK.
- Pedestrians who are blind generally want to be able to hear traffic while crossing the street. The clearance tone or audible message could distract them from hearing traffic or mask the sound of traffic. The continuous nature of a speech countdown has more potential for masking other sounds than the shorter duration of the pushbutton locator tone.
- Additional cognitive processing may be required to interpret a verbal clearance interval message, such as an audible countdown.
- For a blind person, knowing the remaining length of the flashing DONT WALK signal is not useful since they don't have information about the remaining distance to the destination curb.

## REFERENCES

*MUTCD* states that the APS shall indicate the WALK interval, and states that the word 'wait' must precede any message during the clearance interval. (4E.06)

## HOW USED BY PEDESTRIANS WHO ARE BLIND OR WHO HAVE LOW VISION

This feature is not currently used in the US and is not recommended due to the potential confusion of the WALK interval with the clearance interval.

As noted in the disadvantages listed above, pedestrian countdown information is unlikely to provide any advantage to the individual who is blind or visually impaired.

## Integrated information devices

### DESCRIPTION

Personal pagers, cellular telephones, and other mobile digital communications devices could potentially receive transmitted pedestrian signal messages. The increased use of these devices suggests that there may be other technologies and methods to provide information to pedestrians and for pedestrians to call the WALK interval in the future.

Development is ongoing on an integrated handheld computer type device to provide geographic, GPS, intersection layout and real-time signal information to pedestrians who are blind. Communication of a pedestrian call is also being investigated. However, such technology is in the very early development stages.

# Chapter 5:

## When to Install APS

### CHAPTER SUMMARY

This chapter provides guidance on when and where APS should be installed. It contains information on requirements for installation and a tool for prioritizing APS installations.

### CHAPTER CONTENTS

Where are APS Required? .....	82
Prioritizing APS Installations .....	85
APS Prioritization Tool .....	86



## Where are APS Required?

### CURRENT PRACTICE

Currently in the U.S., APS are typically installed upon request along a specific route of travel for a particular individual, or group of individuals who are blind or visually impaired. Various states and municipalities have established policies on installation of APS, some of which may not be in accordance with Americans with Disability Act (ADA) requirements.

### SECTION 504 AND ADA REQUIREMENTS

As discussed in Chapter 1, since 1973, Section 504 of the Rehabilitation Act has required nondiscrimination in all programs, services, and activities receiving federal financial assistance. The ADA requirements for state and local governments extend and increase the requirements in the Rehabilitation Act, requiring newly constructed or altered public facilities to be accessible, regardless of the funding source.

### EFFECTIVE COMMUNICATION

The specific requirement in ADA for effective communication was discussed in Chapter 1. A recent publication by the Federal Highway Administration specifically mentions accessible pedestrian signals as a means to communicate information:

“Implementing regulations for Title II of the ADA, which covers State and local governments, also address “communications and information access,” requiring ‘effective communications’ with persons with disabilities. In the sidewalk/street crossing environment, this would include accessible pedestrian signals, markings and signage.” (FHWA, 2004).

Where there are pedestrian signals, this may require the installation of accessible pedestrians signals to provide access to signal information for pedestrians who are blind or who have low vision.

### ADA STANDARDS FOR PUBLIC RIGHTS OF WAY

As discussed in Chapter 1, ADA standards that specifically address the public rights-of-way have not yet been finalized. *Draft PROWAG* was published on June 17, 2002 for comment and revised on November 23, 2005. These minimum technical standards would require APS at all newly constructed or reconstructed intersections where visual pedestrian signals are installed.

## ACCESSIBILITY STILL REQUIRED

ADA Accessibility Guidelines are minimum guidelines for new construction or reconstruction, and must be applied to the maximum extent feasible in alterations, renovations, or additions.

While the ADA does not require going back and reconstructing all intersections and locations, it does require improving accessibility when work is performed at a location. When an intersection is being completely reconstructed, the expectation is that new construction guidelines can and will be met. See the section in Chapter 6 on new construction for a description of the elements covered by the *Draft PROWAG*.

When certain elements of an intersection are being upgraded, the accessibility features should also be upgraded to new construction standards to “the maximum extent feasible.” The “maximum extent feasible” is explained in the Title II regulations issued by the Department of Justice.

## SELF-EVALUATION AND TRANSITION PLANS

When the ADA regulations were published in 1992, the Department of Justice extended the Section 504 requirement for transition plans and required a ‘self-evaluation’ by all public entities (28 CFR, Part 35.105 Self-evaluation). The goal was that eventually each service, facility and activity of the state or local government, when viewed in its entirety, would be accessible to individuals with disabilities. If structural changes are required to existing facilities to provide program accessibility, a transition plan is required, and 28 CFR, Part 35.150 d discusses the elements of a transition plan. A summary from FHWA Office of Civil Rights provides a short description of requirements:

“A public entity may not deny the benefits of its programs, activities, and services to persons with disabilities because existing facilities are inaccessible.

State and local governments of 50 employees or more were required to prepare a self-evaluation plan to identify program access issues (Rehabilitation Act (1973), section 504).

From this, a transition plan was to be developed to modify inaccessible services, policies and practices. This includes removing barriers and inaccessible features.

Transition plan work was to have been completed by January 1995.

If work was not completed by that date, those entities are out of compliance.

Many states and localities are out of compliance and this makes them more susceptible to lawsuits.

Ways of complying with the law are to have an ongoing transition plan for improving existing facilities and providing a citizen’s request program for accessible parking, curb ramps, Accessible Pedestrian Signals (APS) and removing sidewalk and street crossing barriers.” (McMillen, 2002)

## **APS IN TRANSITION PLANS**

Some municipalities have considered the addition of APS at intersections as part of their ADA transition plan, but many have not. As part of their compliance with ADA, municipalities may need to establish a plan to prioritize and make decisions about installation of APS at “unaltered” intersections:

Where a request for APS is received

Where there is insufficient information for street crossing using non-visual clues

## Prioritizing APS Installations

The information regarding prioritizing intersections for installation of APS is not intended for application to new or reconstructed intersections. In new construction or reconstruction projects, it is appropriate to consider the *Draft PROWAG* as the best guidance available at this time (Isler memo, 2006). In new construction, APS should be installed wherever pedestrian signals are installed.

### WHERE ARE APS NEEDED?

When considering and prioritizing crossings and intersections for retrofit with APS, consideration needs to be given to the information available to pedestrians who are blind and which crossings are in greater need of the APS. A number of factors enter into that decision.

### MUTCD GUIDANCE

The *MUTCD* Section 4E.06 recommends: “The installation of accessible pedestrian signals at signalized locations should be based on an engineering study, which should consider the following factors:

- Potential demand for accessible pedestrian signals;
- A request for accessible pedestrian signals;
- Traffic volumes during times when pedestrians might be present; including periods of low traffic volumes or high turn-on-red volumes;
- The complexity of traffic signal phasing; and
- The complexity of intersection geometry.”

### ADDITIONAL CONSIDERATIONS

Locations that may need APS include those with:

- Vehicular and/or pedestrian actuation
- Very wide crossings
- Crossings of major streets where minor streets have minimal or intermittent traffic (APS may be needed for crossing the major street)
- T-shaped intersections
- Non-perpendicular or skewed pedestrian crossings
- Low volumes of through vehicles
- High volumes of turning vehicles
- Split phase signal timing
- Exclusive pedestrian phasing, especially where right-turn-on-red is permitted
- Leading pedestrian intervals

Where these conditions occur, it may be impossible for pedestrians who are visually impaired or blind to determine the onset of the WALK interval by listening for the onset of parallel traffic. It would also be difficult to obtain usable orientation and directional information about the crossing from the cues that are available. Too little traffic is as great a problem for pedestrians who are blind as too much traffic. In the absence of APS, blind pedestrians must be able to hear a surge of traffic parallel to their direction of travel in order to know when the WALK interval begins.

## **ADVISORY COMMITTEE INVOLVEMENT**

Some jurisdictions may wish to set up a process where ratings are reviewed by an advisory committee of stakeholders, including blind citizens, O&M Specialists and transportation professionals, that assists the traffic engineering department in the process.

In many of the current systems used, crossings with the highest number of points are generally considered highest priority. However, date of request, plans for other construction at the intersection, and other local issues may affect priority of installations.

## **APS Prioritization Tool**

As discussed previously, prioritization information is to be used in prioritizing existing intersections for retrofit with APS either in response to requests, or in updating an ADA transition plan. Prioritization schemes should place only limited emphasis on factors related to frequency or likelihood of use by blind pedestrians. The information provided by APS may be necessary at any time, along any route, to residents, occasional travelers, and visitors. Intersections having high pedestrian volumes are likely to have pedestrians whose vision is sufficiently impaired so as to have difficulty using conventional pedestrian signals.

Of greater importance in prioritizing crosswalks are factors related to determining whether sufficient acoustic information exists—at all times—to permit safe crossing at a particular intersection or crosswalk.

## **PAST RATING SCALES**

Several rating scales have been developed in cities across the country, some of which have been utilized for over 20 years. These rating scales have been used in different ways in different cities. In some locations, they were developed as warranting schemes and APS were not installed unless the intersection met a required minimum number of points. Other cities used rating scales only to aid in prioritization.

Generally, points are assigned to specific intersection features, as well as proximity to services (such as transit, government offices, or shopping) for all pedestrians. The cities of San Diego, Los Angeles, and Portland, as well as the state of Maryland, have used point rating scales as part of their process.

The parties responsible for rating the intersections vary according to the locality. In San Diego, a traffic engineer and an O&M Specialist rate separate aspects of the intersections. In Los Angeles and Portland, the rating is conducted jointly by an O&M Specialist and a traffic engineering department staff member. In Maryland, the DOT engineer determines the rating.

## APS PRIORITIZATION TOOL OVERVIEW

The APS Prioritization Tool was developed as part of this research (National Cooperative Highway Research Program, Project 3-62). The tool provides traffic engineers and other technical practitioners with the means to take observable characteristics of a pedestrian crosswalk and produce a rating that reflects the relative crossing difficulty for pedestrians who are blind, thus enabling prioritization of crosswalks for installation of APS. Practitioners can use this tool to determine these ratings for each crosswalk. The crosswalks with the highest ratings will have the highest priority for APS installation. While an overview of the tool and an example of use are shown in this chapter, the full instruction manual and blank Prioritization Tool forms can be found in Appendix D.

The Prioritization Tool calculates the prioritization score for a crosswalk based on characteristics of the crosswalk itself and the intersection at which it is located. Characteristics that cause a crosswalk to have a greater need for APS are assigned higher point values.

### Intersection Characteristics

- Number of intersection legs
- Signal design (e.g., pre-timed, actuated, etc)
- Proximity of transit facilities
- Proximity to facilities providing services for people who are blind or visually impaired
- Proximity to major pedestrian attractors (e.g., sports arena, downtown area, etc.)

### Crosswalk Characteristics

- Crosswalk width
- Speed limit
- Approach and crosswalk geometrics (e.g., skewed crosswalks, large curb radii, islands or medians, etc.)
- Pedestrian signal control (e.g., pushbutton actuation required for WALK signal, leading pedestrian interval, etc)
- Vehicle signal control (e.g., right-turn-on-red, leading protected left turn phase, etc)
- Off-peak traffic presence
- Distance to alternative APS crosswalk

- Pedestrian pushbutton location
- Requests for APS

## APS PRIORITIZATION TOOL VALIDATION PROCESS

Although prior rating scales included many relevant factors, the point values assigned to these factors were not thoroughly tested in a field validation. The APS Prioritization Tool underwent validation through comparison with expert opinion from O&M Specialists and blind pedestrians. The steps in producing and validating the tool were as follows:

1. The research team selected factors (e.g., crosswalk width, signal design) to include in the tool. Factors that made crossing more difficult for blind pedestrians were given higher point values. This produced the initial form of the prioritization tool.
2. The team selected crosswalks in three cities (Cambridge, MA; Tucson, AZ; and Charlotte, NC). Each crosswalk was rated with the initial prioritization tool. The same crosswalks were rated by O&M specialists and blind travelers who ranked them in order of difficulty for blind pedestrians.
3. The two sets of rankings were compared. The places where the prioritization tool results differed from the expert results showed where the tool's point values needed to be raised or lowered.

This process produced a tool that was validated by comparison to expert opinion in real-world situations.

## EXAMPLE USES OF THE APS PRIORITIZATION TOOL

The following example shows how the Prioritization Tool would be used to score a crosswalk that would be relatively difficult; an additional example showing a relatively easy crosswalk is included in Appendix D.

### *Example Crosswalk*

This example rates a crosswalk at a large intersection of a major arterial and a minor side street. The crosswalk of interest is on the east leg (highlighted in Figure 5-1; shown at street level in Figure 5-2).

The first worksheet deals with the intersection characteristics (Figure 5-3). Points were given for the following reasons:

- The signal is actuated but also uses split phasing, which is a higher point value than actuation, so the intersection gets the six points for split phasing. Split phasing is a less commonly used signal design, and the typically heavy turning movements make it harder to effectively use the traffic movement cue to determine signal changes. APS would provide a definitive cue to the onset of the WALK interval for pedestrians who are unable to see the pedestrian signal.



**Figure 5-1. Overhead view of Example Crosswalk (Google Earth © 2005)**



**Figure 5-2. Street view of Example Crosswalk**

- There is a single bus route on the main street, which earns another point. The presence of public transit increases the likelihood that visually impaired pedestrians will travel at this intersection, thereby increasing the priority for APS.

There are no facilities specifically providing services for individuals who are visually impaired or major pedestrian attractors within one-half mile, so no points are given for those categories. The total intersection score is seven points.

The second worksheet deals with the crosswalk (Figure 5-4). Points were given for the following reasons:



- The crosswalk width of 110 feet and speed limit of 45 mph on the main street earn the crosswalk four and five points, respectively. Wider crosswalks and faster traffic increase the crossing difficulty and risk to visually impaired pedestrians, and APS may help expedite their crossing.
- The curb radius on one of the corners bordering the crosswalk is greater than 25 feet, so one point is given in the geometrics category. Larger curb radii create orientation problems for visually impaired pedestrians that may be decreased with the use of an APS.
- The signal requires push button actuation for the pedestrian WALK signal, so four points are given for the pedestrian signalization category. An APS locator tone would help a pedestrian who is visually impaired recognize that there is a pushbutton at that crosswalk and help in locating the pushbutton, and would increase the likelihood that pedestrian who is blind would use the pushbutton.
- Right-turn-on-red (RTOR) is permitted at the crosswalk, so two points are given in the vehicle signal control category. RTOR may produce misleading traffic cues, and an APS would provide a definitive cue of the appropriate time to cross.

**Figure 5-3. Intersection Worksheet for Example Crosswalk**

Intersection Prioritization Tool for Installation of Accessible Pedestrian Signals, NCHRP 3-62, 2006			
<b>Intersection Worksheet</b>			
<b>Location:</b> CENTRAL & KILBOURNE/NORLAND			
<b>Sketch:</b> See instructions for information to include. Label crosswalks as A, B, C, D, etc.  	<b>Configuration (select one)</b>	Points	Score
	4-leg 4-leg offset 3-leg (T or Y) 5 or more legs Midblock location	0 3 3 12 14	0
	<b>Signalization* (select one)**</b>	Points	Score
	Pre-timed Actuated (somi or fully) Split phasing Exclusive ped phase	0 2 6 8	0  6
	<b>Transit Facilities within a block (~ 1/8 mile) of the intersection - all legs (select one)</b>	Points	Score
	No transit facilities Single bus route Multiple bus routes Transit mall/rail station	0 1 3 5	1
	<b>Distance to Facility for Visually Impaired (select one)</b>	Points	Score
	> 2600 ft (~1/2 mile) < 2600 ft (~1/2 mile) < 1300 ft (~1/4 mile) < 650 ft (~1/8 mile) < 300 ft	0 4 6 8 10	0
<b>Other Intersection Level Issues</b>  Split phasing	<b>Distance to Major Pedestrian Attraction (select one)</b>	Points	Score
	> 2600 ft (~1/2 mile) < 2600 ft (~1/2 mile) < 1300 ft (~1/4 mile) < 650 ft (~1/8 mile) < 300 ft	0 2 3 4 5	0
* For intersections only. Signalized midblock locations are accounted for under Configuration. ** Select the option with the highest point value that applies to the situation.			
<b>Intersection Worksheet Score:</b> (sum of scores on this page)			7

Intersection Prioritization Tool for Installation of Accessible Pedestrian Signals, NCHRP 3-62, 2006					
<b>Crossing Worksheet</b>					
(Complete one sheet for each crossing)					
Location: <u>CENTRAL &amp; KILBOURNE / HOWLAND</u>			Crosswalk Label: <u>D</u>		
<b>Crossing Width (select one)</b>		Points	Score	<b>Speed Limit (select one)</b>	
< 40 ft		0		< 20 mph	
40 - 59 ft		1		25 mph	
60 - 79 ft		2		30 mph	
80 - 99 ft		3		35 mph	
100 - 119 ft		4	4	40 mph	
≥ 120 ft		5		≥ 45 mph	
<b>Approach/Crossing Geometrics (select all that apply)</b>				Points	Score
Skewed crossing				7	
Curb radius > 25 ft (either corner)				1	1
Apex curb ramp (either corner)				2	
Channelized right turn island				2	
Islands or medians (painted, raised or cut-through)				1	
Transverse slope on crosswalk				1	
<b>Pedestrian Signal Control (select all that apply)</b>				Points	Score
Timed for crossing to median crossing island				8	
Push button actuation required for WALK signal				4	4
Leading Pedestrian Interval (LPI) with parallel street green				8	
Non-concurrent WALK interval				4	
<b>Vehicle Signal Control (select all that apply)</b>				Points	Score
Protected right turn phase / right turn overlap (on parallel street)				7	
Leading protected left-turn phase (on parallel street)				3	
Right-Turn-On-Red permitted (on parallel street)				2	2
Channelized right turn lane under signal control				8	
<b>Off-Peak Traffic Presence - at least 2 vehicles present on parallel street (select one)</b>				Points	Score
Constant (≥ 90 percent of cycles)				1	
Heavy (70 - 80 percent)				2	2
Moderate (50 - 60 percent)				3	
Light (30 - 40 percent)				4	
Occasional (< 30 percent)				5	
None (i.e., no through lanes present to create surge noise - e.g., stem of T-intersection)				6	
<b>Distance to Alternative APS Crossing (select one)</b>		Points	Score	<b>Pedestrian Pushbutton Location - either corner (select all that apply)</b>	
< 300 ft		0		Located > 10 ft from curb	
< 650 ft (~ 1/8 mile)		1		Located > 5 ft from the CW extd.	
< 1300 ft (~ 1/4 mile)		2			
< 2500 ft (~ 1/2 mile)		3		<b>Requests for APS (select one)</b>	
> 2600 ft (~ 1/2 mile)		4	4	No requests	
				1 or more requests	
<b>Other Crossing Level Issues</b>				<b>Crossing Worksheet Score:</b> (score from this page) <u>25</u>	
				<b>Intersection Worksheet Score:</b> (score from intersection form) <u>7</u>	
				<b>Total Crossing Score:</b> (add the two above scores) <u>32</u>	

Figure 5-4. Crosswalk Worksheet for Example Crosswalk

- During off-peak hours, there was enough parallel traffic to provide audible cues (2 or more vehicles per cycle) about 75% of the time. This earns two points.
- There is not an alternative APS crosswalk within one-half mile, so four points are given towards the prioritization of an APS installation at this crosswalk.
- The pedestrian push button at one end of the crosswalk is located more than 10 feet from the curb, which is contrary to the recommendations in Section 4E.09 of the *MUTCD*. Three points are given for this drawback, since a correctly installed APS would position the push button closer to the curb which facilitates orientation alignment and pushbutton use for blind and visually impaired pedestrians.

The crosswalk worksheet score is 25 points. When added to the intersection score of seven points, this yields a total crosswalk score of 32 points. In practice, this score of 32 points would be compared to other crosswalks under consideration for APS installations. Those crosswalks with the highest scores would have the highest priority for APS.



# Chapter 6:

## Designing APS Installations

### CHAPTER SUMMARY

Accessible Pedestrian Signal installations require engineering, including detailed drawings and specifications. Complex intersections require complex decisions and the use of engineering judgment. A number of factors must be considered in designing the installation. This chapter contains guidance on how to design an APS installation that works well for the user and the environment.

### CHAPTER CONTENTS

Principles .....	94
Optimal APS Location .....	95
Signal Phasing Considerations .....	98
Intersection Geometry Considerations .....	103
APS Design in New Construction .....	105
APS Design at an Existing Intersection .....	109
Needs Assessment .....	110
Pole Location .....	112
Specifications .....	115
Mounting and Wiring Issues .....	117
APS Microphones and Speakers .....	122
Summary of Recommended Features and Installation Practice .....	131

# Principles

## GENERAL PRINCIPLES IN THE DECISION:

- Provide pedestrian signal information to those who cannot see the pedestrian signal head across the street
- Provide information to pedestrians about the presence and location of pushbuttons, if pressing a button is required to actuate pedestrian timing
- Provide unambiguous information about the WALK indication and which crossing is being signaled
- Use audible beaconing only where necessary
  - o Put as little additional sound in the environment as possible
  - o Avoid disturbance of neighbors
  - o Allow pedestrians who are blind or visually impaired to hear the traffic sounds, as well as the APS

## FEATURES

In many cases, a municipality or state will wish to purchase one style of APS device for all installations. However, there are engineering and design decisions in the installation of APS, as well as in the choice of equipment.

More latitude in specifications may be applied when the APS is an addition to an existing intersection. The Americans with Disabilities Act (ADA) typically requires new construction to meet ADA guidelines, while it requires additions or alterations to meet the guidelines to the maximum extent feasible. Understanding the basic considerations is necessary to designing usable installations in both new and retrofit situations.

In new construction or reconstruction, where the APS can be located consistently, it is likely possible to use standardized device features and mounting locations for all installations. When retrofitting intersections with APS, it may be necessary to use different features to provide unambiguous information at different intersections. See Chapter 4 for a listing and description of APS features.

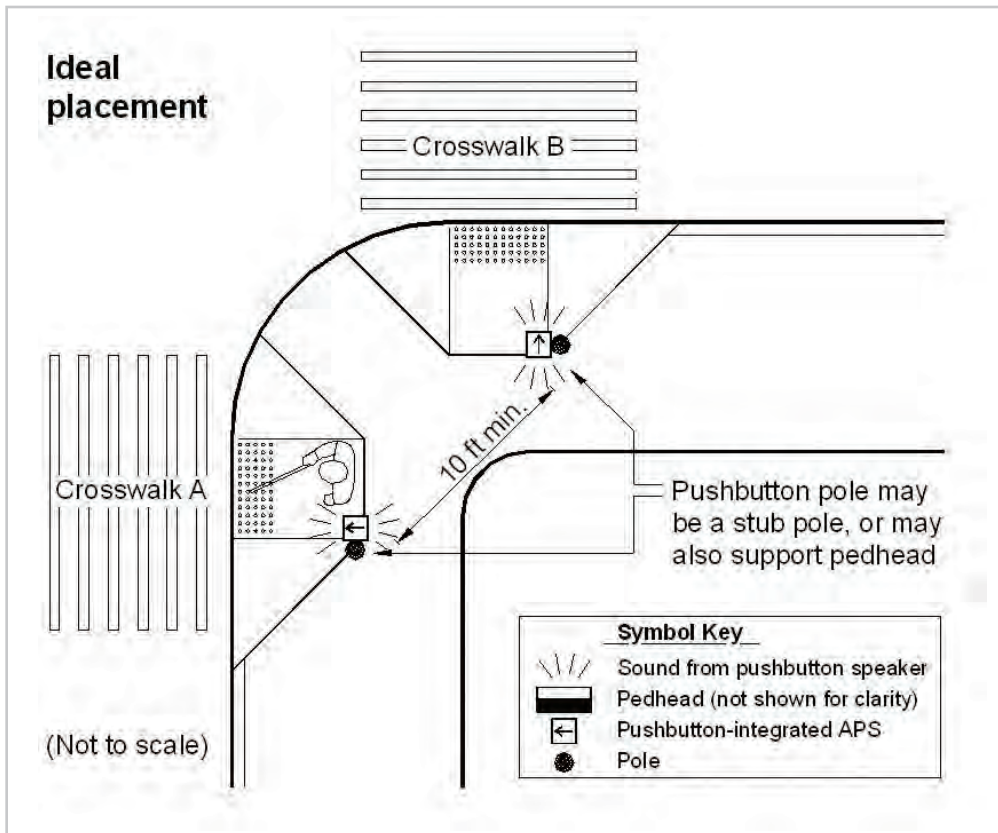
## DEVICE LOCATION

Device location is critical to the functioning of the APS and needs to be planned. The APS may provide ambiguous information if located incorrectly, just as pedestrian or vehicular signal heads can provide ambiguous, or even dangerous, information if located incorrectly. Engineering judgment is required to determine the best way to install APS at a given intersection and crossing. Differences in curb radius, width of right-of-way, presence of a parkway (grass buffer), curb ramp design and location, and existing infrastructure on corners make each installation different.

Whenever possible, two poles should be installed for APS speakers to be located close to the pedestrian departure location and crosswalk, as described in detail below. Recommendations about location and WALK indication have been updated as a result of recent research (see Appendix C for research results).

## Optimal APS Location

The optimal location for pushbutton-integrated APS is between the edge of the crosswalk line (extended) farthest from the center of the intersection and the side of the curb ramp. APS should be between 1.5 feet and 6 feet from the edge of the curb, shoulder, or pavement but no further than 10 feet from the edge of the curb, shoulder or pavement. These distances are the same as those recommended for all pedestrian pushbuttons in the Proposed 2009 MUTCD, Section 4E.08. The control face and tactile arrow should be carefully aligned with the direction of travel on the associated crosswalk. In order to provide wheelchair users with access to the pushbutton, pushbuttons need to be located adjacent to a level all-weather surface.

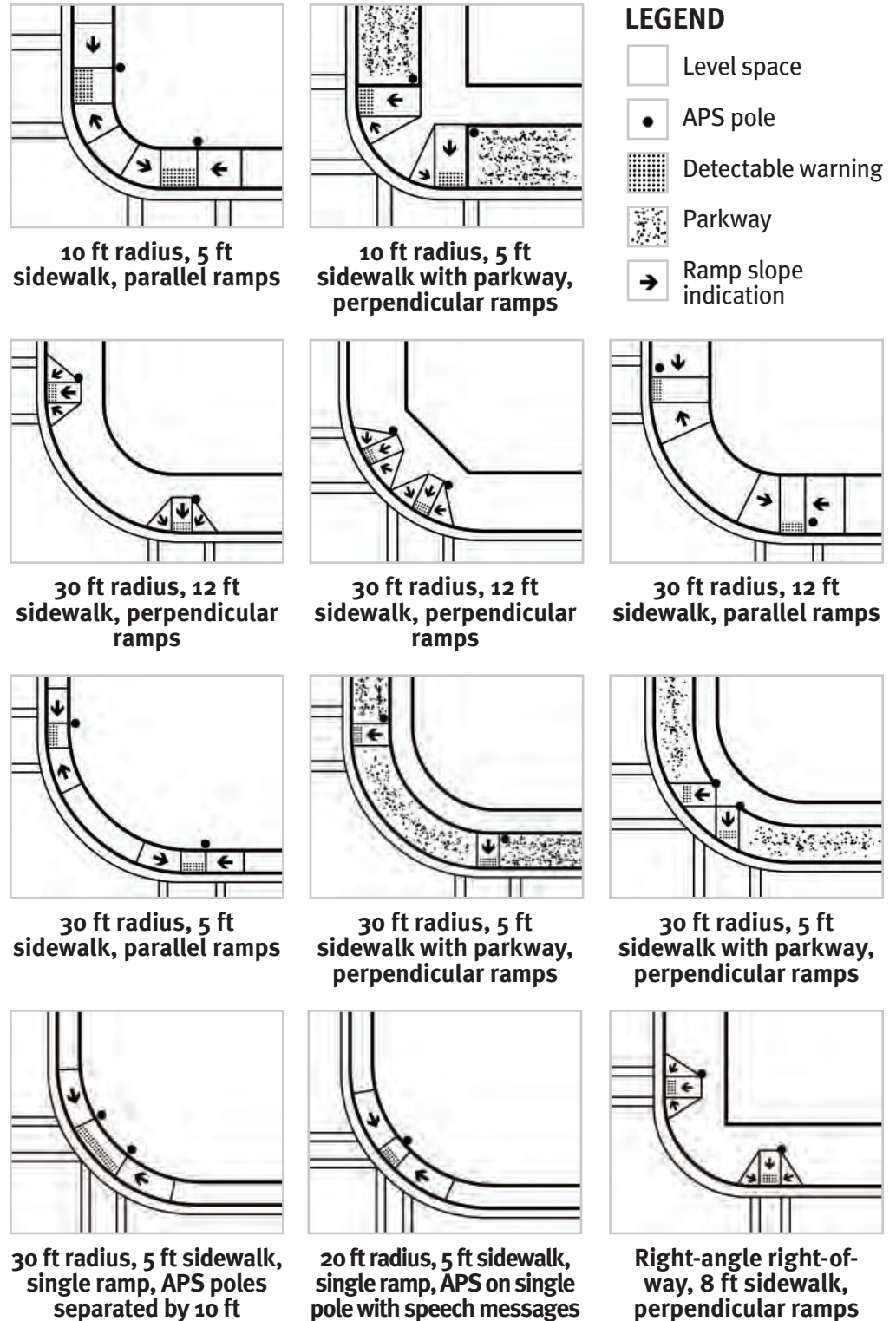


**Figure 6-1. Optimal location of pushbutton-integrated APS (two pushbuttons on one corner, mounted on two separated poles – rapid tick WALK indication)**

Pushbutton and speakers for the APS need to be less than 5 feet from the edge of the crosswalk line (extended) farthest from the center of the intersection. At corners of signalized locations where two pedestrian pushbutton and APS are provided, the pushbuttons should be separated by a distance of at least 10 feet (see Figure 6-1). A rapid tick WALK indication is recommended for installations following these guidelines for location.

When pushbuttons are precisely and consistently located in this way, identification of which crossing is being signaled can be based solely on which pushbutton the WALK signal comes from. There is no need to remember a code (such as cuckoo for a north/south crossing and rapid tick for an east/west crossing) or to understand speech messages. Figure 6-2 provides examples of pole arrangements that meet the requirements for corners having different geometries. Figure 6-3 demonstrates acceptable APS placement at a corner with an improper ramp design.

**Figure 6-2. Examples of locations for APS on corners with various geometries**



## APS INSTALLATION WHERE TWO SEPARATED POLES ARE NOT POSSIBLE

Where the only work being done is the addition of APS to existing poles, or where it is technically infeasible, because of limited right-of-way, topography, or locations of other essential equipment on corners, to install two APS on separate poles on the corner, it may be necessary to install two APS on a single pole. However, the APS features required for this situation are different from those where APS and APS sounds are separated.

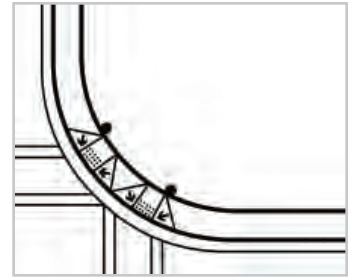
When it is necessary to mount two pushbuttons on one pole without a separation of 10 feet or more:

- speech WALK messages are recommended rather than tones
- pushbutton information messages identifying the intersection and the street to be crossed are needed, to be sure users know the street name to listen for in the WALK message

Research in Portland demonstrated that the participants' identification of which crosswalk had the WALK signal was significantly more accurate when the APS provided speech WALK signals from both APS than when the APS used two different tones — cuckoo and rapid tick (see Appendix C).

## NEED FOR AUDIBLE BEACONING

Audible beaconing is the use of an audible signal in such a way that blind pedestrians can home in on the signal from the opposite corner to aid in alignment during the crossing. The need for audible beaconing may affect the type of device to be installed and the installation location. Not all manufacturers' devices are capable of providing audible beaconing. The need for beaconing should be evaluated and considered early in the design of the installation. A minority of crossings is likely to require beaconing and not all crosswalks at an intersection may need beaconing. Beaconing may actually cause confusion if used at some locations. See Chapter 4 for suggested criteria for audible beaconing.



**Figure 6-3. Acceptable APS placement at location but inaccessible ramp design (no level space for passage on the sidewalk)**



# Signal Phasing Considerations

## INTRODUCTION

Some signalization schemes, such as exclusive pedestrian phasing and split phasing, need careful adjustment and consideration to avoid confusing pedestrians who are blind. Crossings with pedestrian signals that rest-in-WALK may need special treatment. These issues must be considered in the design phase in determining type of device and location. In addition, careful adjustment of APS volume after installation is essential.

## SPLIT PHASING

Split phasing is a signal design that gives a green phase for all vehicle movements of one direction (e.g., northbound through, right, and left) followed by a phase for all movements of the opposite direction (e.g., southbound through, right, and left). At a location with split phasing, an APS that can be heard from the parallel crosswalk may provide incorrect, confusing, and dangerous information. **It is critical** that the WALK indication be audible only from the ends of the crosswalk being signaled so pedestrians at other crosswalks do not begin to cross at a time when vehicles are turning across their path in a protected vehicular movement.

This can be accomplished by locating the APS very close to the crossing location so pedestrians can readily determine which signal applies to their crosswalk. Careful adjustment of the APS volume at all times of the day and night, as well as careful aiming of the speakers is critical. Audible beaconing may not be appropriate at locations with split phasing, due to the possibility of confusion of signals.

Possible strategies:

- An APS mounted at the pushbutton location with carefully set volume and placement to be heard only at the crossing location (see photos and further discussion in Chapter 7).
- A pushbutton that actuates the audible WALK indication only for the crosswalk that received the pedestrian call.

## ACTUATED TURN PHASING

In some timing plans for actuated turn phasing, traffic in one direction may be held longer to allow the opposing traffic to complete left turning movements. In many such cases, the pedestrian phases on parallel crosswalks begin at different times. An APS that can be heard from the parallel crosswalk provides incorrect, confusing, and dangerous information and could mislead a pedestrian to cross when vehicles are turning across their path in a protected vehicular movement.

Possible Strategies:

- An APS with speakers mounted at the pushbutton, or pedestrian signal head, with carefully set volume and very careful placement and adjustment, to be heard only at the crossing location (see photos and discussion in Chapter 7).
- A pushbutton that actuates an audible WALK indication only for the crosswalk that received the pedestrian call.
- Having the audible WALK indication sound only during that part of the WALK interval that is common to both of the parallel lanes, provided that the pedestrian clearance time remains long enough to enable pedestrians crossing with audible cues to complete their crossing before the end of the clearance interval.

## **APS WHERE PEDESTRIAN TIMING IS PUSHBUTTON-ACTUATED**

Pushbutton-actuated pedestrian timing requires a pedestrian to locate the pushbutton and push it to request the pedestrian phase. A pedestrian who is blind needs to know a button-press is required to actuate a pedestrian timing, and needs to be able to find the pushbutton easily. The most appropriate way to convey that information is with a locator tone at the pushbutton. Draft Public Rights-of-Way Accessibility Guidelines (Draft PROWAG) require APS with a pushbutton locator tone where there are pedestrian pushbuttons. Likewise, the MUTCD 4E.09 guidance states that “[APS] pushbuttons should be audibly locatable.” See Chapter 4 for a description of pushbutton locator tones.

### *Location of APS pushbuttons for actuated signals*

To be useful to pedestrians who are visually impaired, pushbuttons must be installed as near to the crosswalk as possible, preferably on the sidewalk within the width of the crosswalk connection or adjacent to the crosswalk, and as close to the curb as possible.

Pedestrians who are blind must locate and push the pushbutton, and then align to cross as discussed in Chapter 2. Even with an accessible signal, a pedestrian who is blind or visually impaired may not cross on the first WALK indication, but may need to listen to traffic and the accessible signal for a cycle to confirm alignment, the signal functioning, and traffic direction before pushing the pushbutton again, realigning and crossing on the following pedestrian phase.

## **EXCLUSIVE PEDESTRIAN PHASING**

Exclusive pedestrian phasing (also known as scramble phasing) is a signal phase when all vehicle movements are stopped and all pedestrian crosswalks are given the WALK signal. This makes it difficult for pedestrians who are blind or visually impaired to recognize the onset of the WALK interval, particularly at locations where right on red is permitted. In addition, there is no vehicle flow to aid in crossing straight to the destination corner.

In some locations, pedhead-mounted APS have been installed on all corners and two different sounds for different crossing directions have been set to sound during the

WALK indication. This is not recommended, as it is confusing to all pedestrians, and pedestrians who are blind typically assume that the signals are broken.

Possible Strategies:

- Provide the same tone from all APS during the walk interval.
- A pushbutton information message, followed by a WALK tone, was used in a pilot project in Morgantown, West Virginia, at an intersection with exclusive pedestrian phasing. The pushbutton information message was modeled after the phrase: “Wait to cross Howard at Grand. Wait for red light for all vehicles. Right turn on red permitted.” During the WALK interval, all pushbutton-integrated devices at the intersection emitted the same, rapidly repeating, tone. Only one APS was installed on some corners, with a tactile symbol, with arrows pointing in two directions, installed on the top of the device,. See the Morgantown case study in Chapter 9.
- Where mixed exclusive and concurrent pedestrian phasing is used, pushbutton-integrated APS located beside each crosswalk can be used to provide the audible information. APS with speakers mounted at the pushbutton should have carefully set volume and placement to be heard only at the crossing location.

## REST-IN-WALK

At locations where the pedestrian signal to cross the minor street rests-in-WALK, the WALK indication would sound constantly for that crossing. In many locations, that might prove to be irritating to neighbors.

Possible strategy:

- Some APS manufacturers provide a limit switch that limits the length of the audible WALK indication to seven or eight seconds, but allows recall of the audible and vibrotactile indications of the WALK, if the button is pressed when there is adequate clearance time remaining. The availability of that feature should be investigated in the installation planning.

## APS IN A DOWNTOWN AREA WITH PRETIMED SIGNALS

Many agencies in large cities deal with the issue of how to handle APS in downtown areas. These areas are characterized by closely spaced buildings, higher amounts of pedestrian traffic, and pretimed traffic signals that often work as part of a coordinated system. Engineers may be resistant to installing pushbutton-integrated APS in this environment for several reasons, such as poles not being located in the appropriate locations, concerns over the nuisance of the APS tones to the surrounding offices and shops, and an understandable unwillingness to install a pushbutton at a signal that does not require pushbutton actuation. It is tempting to use only pedhead-mounted APS. However, engineers should recognize that there are still many benefits to pushbutton-integrated APS in a downtown area.

## *Benefits of pushbutton-integrated APS in a downtown area*

Engineers may wonder why they should install a pushbutton-integrated APS if pushing the button has no effect on a pretimed signal. The key is to realize that pushbutton-integrated APS have several features that are beneficial to blind pedestrians, even if there is not a need to push the button:

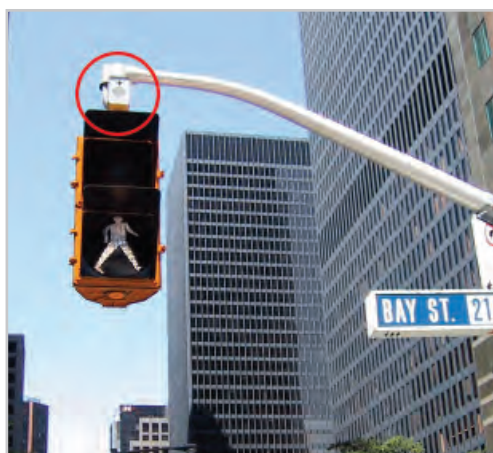
- Audible WALK indication—same as for any intersection, the audible WALK indication will let the blind pedestrian know that the walk interval has started so that they will not have to rely solely on traffic noise.
- Locator tone—though it is not necessary that the blind pedestrian find the button to push it, the locator tone is helpful in guiding the blind pedestrian to the proper starting place for making the crossing. For this to be helpful, it is important that the pushbutton pole is located correctly (i.e., close to the pedestrian departure point).
- Tactile arrow—the tactile arrow provides information about which crosswalk is being signaled and what is the location and direction of that crosswalk.
- Vibrating surface—pedestrians with poor hearing can keep their hand on the vibrating surface and know when the walk interval has started.

## *Sound issues in a downtown area*

Engineers and city officials may also be concerned about the amount of noise that pushbutton-integrated APS will introduce to the downtown area. It must be understood that APS are not intended to be loud devices, and they should not be configured as such. Refer to Chapter 7 for sound level specifications. Those installing APS should calibrate the sound carefully and be aware of the fact that sound will reflect off the closely spaced buildings in a downtown area.

## *Audible signals mounted on the pedestrian signal head*

When the addition of the APS is the only change planned at an intersection with pretimed signals, and a pushbutton absolutely cannot be installed in a location where the tactile arrow and vibrotactile information associated with the pushbutton is usable, it makes little sense to install an APS with those features. A pedhead-mounted APS without a pushbutton or locator tone may be appropriate in that situation.



**Figure 6-4.** The mast arm is used in this installation in Toronto, Canada to position pedestrian signal head and speaker closer to the crosswalk.

This suggestion does not apply at new or reconstructed intersections. An installation without the tactile arrow and vibrotactile WALK indication would not comply with the Draft PROWAG requirements for new construction. Such an installation

might be considered to meet them to the maximum extent feasible, when existing conditions and structures prevent installation of additional poles to mount the APS beside the crosswalk.

When an APS is mounted on pedestrian signal heads, the WALK message or tone and volume levels should be carefully determined to avoid confusion to pedestrians, and to prevent disturbance to neighbors. Unless audible beaconing is determined to be necessary, the APS speaker should be oriented down toward the waiting location of the pedestrian. Use of a small mast arm to locate the APS optimally over the crosswalk location might be appropriate (Figure 6-4).

## Intersection Geometry Considerations

### EFFECT ON APS

An APS that is audible from the wrong crossing location may lead a visually impaired pedestrian to begin to cross at the incorrect time and place. Geometric features, such as unsignalized and signalized right turn lanes, have been recognized as situations of concern in language in the MUTCD.

The type of APS may not be as important as the location of the sound source and volume of the WALK indication. These issues must be considered in the design phase in determining type of device and location. Also, careful adjustment of APS volume after installation is essential.

### UNSIGNALIZED RIGHT TURN LANES AND SPLITTER ISLANDS

An unsignalized right turn lane can pose a problem if the APS for crossing the signalized main through lanes of the intersection is too loud. Pedestrians who are unaware of the existence of an unsignalized right turn lane may reach the curb, hear the APS sounding and cross the unsignalized lane, thinking that it is signalized.

This concern is the reason that MUTCD 4E.06 urges careful selection of tones at locations with free right turns. However, tone selection does not really provide a solution; volume of the sound and placement of the speaker are the important issues. The Proposed 2009 MUTCD has been revised to state that “the sound level of audible pedestrian indications should be adjusted to be low enough to avoid misleading pedestrians who have visual disabilities...” at locations with unsignalized right turn lanes.

The APS must be adjusted so it is only heard from the location where the pedestrian is waiting to cross and only audible for the crosswalk being signaled. It is generally not appropriate to use audible beaconing where there are splitter islands because the volume cannot be controlled precisely enough. As discussed in the section on split phasing, volume and placement of the sound source are critical considerations in designing and installing the APS.

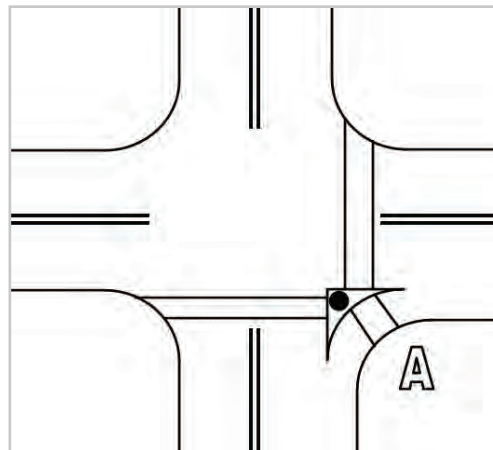


Figure 6-5. APS at channelized turn lane

In Figure 6-5, a pedestrian standing on the corner at location A should not be able to easily hear the APS that is located on the splitter island and intended for use by pedestrians crossing the through lanes.

## SIGNALIZED CHANNELIZED RIGHT TURN LANES

Where crosswalks from corners to splitter islands are signalized, the signals to cross to the island might not be concurrent with traffic movement parallel to the pedestrian who is blind, depending on the crossing location. APS should be located precisely next to the associated crosswalks with careful volume adjustment. Pedestrians waiting on the island must not confuse the WALK indication for the turn lane with the WALK indication for the through lanes of the intersection. Pedestrians approaching the corner can also be guided to the crosswalk by a locator tone in combination with curb ramp location. Because signalized right turn lanes can be confusing for pedestrians who are blind, installation of APS with pushbutton locator tones at signalized right turn lanes should be given high priority.

## MEDIANS

If the pedestrian clearance time is sufficient only to cross to a median having an additional pushbutton, it is very important that the pushbutton on that median be an APS with a locator tone. This may inform the pedestrian who is visually impaired that a second button press is needed to complete the crossing, and will aid in location of the median and the pushbutton. If only one APS device is on the median, the pushbutton should have a double-ended arrow.

**Figure 6-6. APS at median midblock crossing**



If pedestrian phases for the two halves of the street are timed separately, two pushbutton-integrated APS are needed on the median, separated by as much distance as possible, and located as close to each crossing departure location as possible. In addition to the locator tone of an APS, a fence and offset crosswalks are used in European and Australian cities to alert all pedestrians about the need to stop on the median and wait for the next pedestrian phase.

At this median island in Ireland (Figure 6-6), an APS is provided for each crossing, and a fence prevents pedestrians from continuing straight across the street, requiring the pedestrian to turn and walk to the other crosswalk location and pushbutton.

# APS Design in New Construction

## DRAFT PROWAG

Revised Draft Public Rights-of-Way Accessibility Guidelines (Draft PROWAG) were released on November 23, 2005. While Draft PROWAG has not been published as a final rule, it should be considered as the best guidance available at this time (Isler memo, 2006).

## APS CHARACTERISTICS

The Draft PROWAG requires APS with the following features in new construction and reconstruction where pedestrian signals are installed:

- APS devices integral with the pushbutton
- Audible and vibrotactile indications of the WALK interval
- WALK indication by tone or speech message
- Pushbutton locator tone wherever there is a pedestrian pushbutton
- Pushbutton that is a minimum of 0.5 cm (2 in) across in one direction and that contrasts visually with its housing or mounting
- Tactile arrow indicating the direction of travel on the crosswalk, and
- Braille or verbal information about the name of the street.

### *Optional features*

The Draft PROWAG states that an extended button press shall be permitted to activate additional features. However, no information is provided which specifies what those features may include (see Chapter 4 for discussion of extended button press and possible features).

### *Location in new construction*

The Draft PROWAG specifies that APS devices shall be located as follows:

- In such a way that the vibrotactile feature can be contacted from the level landing of a curb ramp, or from clear ground space in line with the crosswalk line adjacent to the vehicle stop line,
- Within specified reach ranges from a level landing,
- 3 m (10 ft) minimum from other APS at the crossing, with an exception to that distance for devices installed on medians, and



**Figure 6-7. APS installation in new construction**



- With control face of the device installed facing the intersection, parallel to the direction of the crosswalk it serves.
- Clear floor or ground space at the pushbutton shall connect to or overlap the pedestrian access route.

### *MUTCD recommended locations*

MUTCD recommendations do not specify the locations for new construction in the same manner, but are substantially the same as locations required in new construction and reconstruction by Draft PROWAG. MUTCD 4E.09 states

“Pushbuttons for accessible pedestrian signals should be located... as follows:

- Adjacent to a level all-weather surface to provide access from a wheelchair, and where there is an all-weather surface, wheelchair accessible route to the ramp;
- Within 1.5 m (5 ft) of the crosswalk extended;
- Within 3 m (10 ft) of the edge of the curb, shoulder, or pavement; and
- Parallel to the crosswalk to be used.“

In the Proposed 2009 MUTCD, Section 4E.09 states that APS detectors should be located close as possible to the crosswalk line furthest from the center of the intersection and as close as possible to the curb ramp. In Section 4E.08 of the Proposed 2009 MUTCD, the locations for all pushbuttons (pedestrian detectors) has been revised to require that all pushbuttons to be located within 5 feet of the crosswalk line extended and within six feet of the edge of the curb, except at locations “where there are constraints that make it impractical to place the pedestrian pushbutton between 0.45 m (1.5 ft) and 1.8 m (6 ft) from the edge of the curb, shoulder, or pavement.” In that case, it should not be farther than 3 m (10 ft) from the edge of curb, shoulder, or pavement.

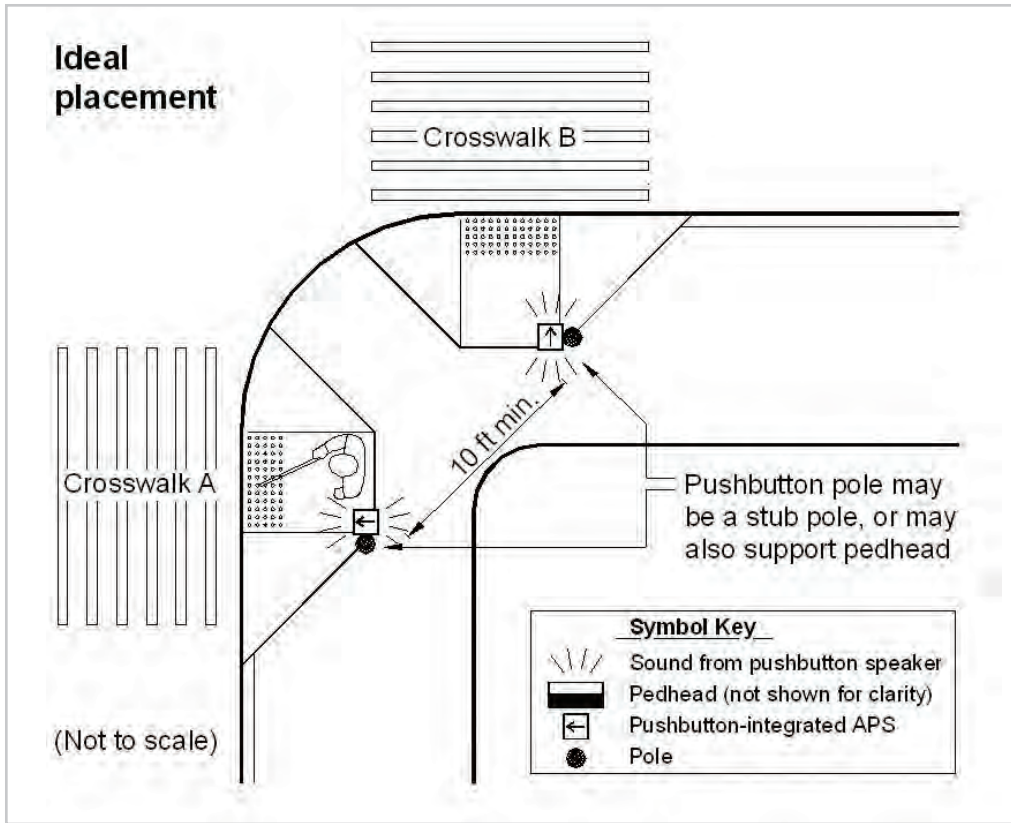


Figure 6-8. Ideal placement for pushbutton-integrated APS

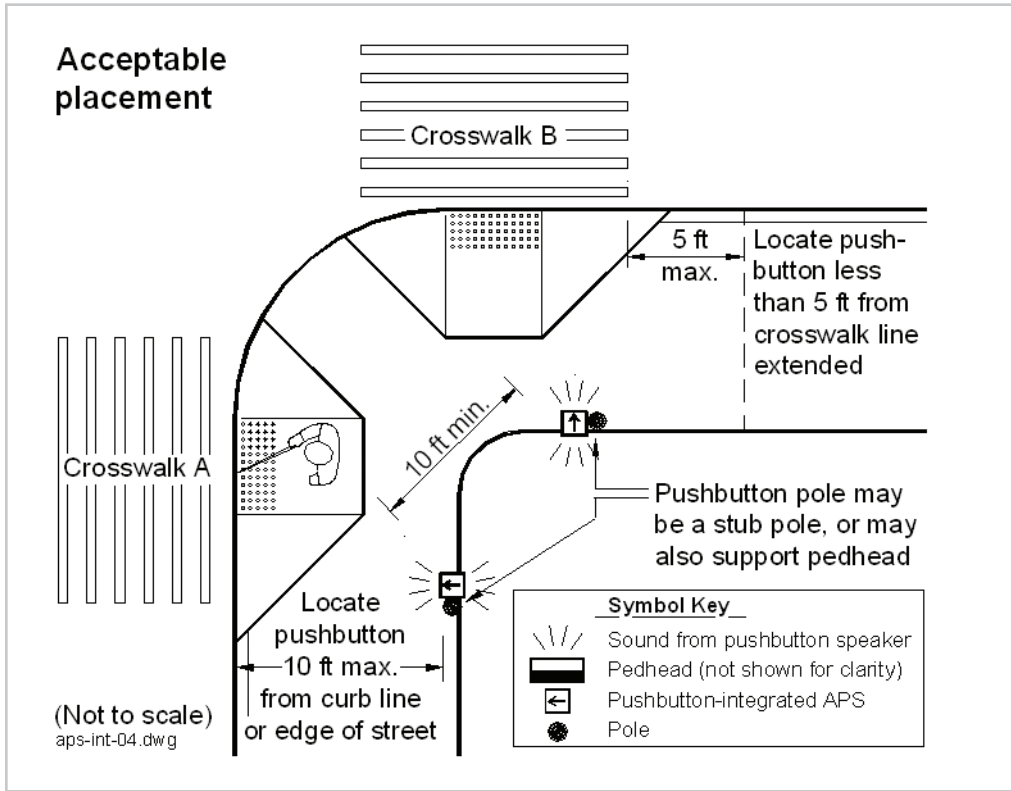
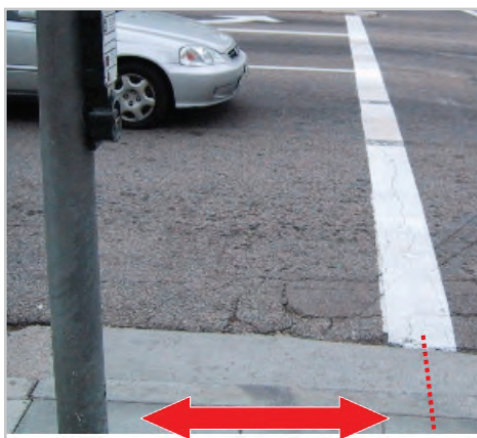


Figure 6-9. Acceptable placement for pushbutton-integrated APS

**Figure 6-10.** The APS should be located on the intersection side of the pole, as shown in this photo



**Figure 6-11.** The MUTCD states that the APS should be within 5 feet of the crosswalk line extended



**Figure 6-12.** The APS should be within 10 feet of the curb



**Figure 6-13.** APS installed in this reconstruction location are in accordance with the Draft PROWAG in that they are beside a level landing and separated from each other by at least 3 m. Both APS are located on the intersection side of their poles.



# APS Design at an Existing Intersection

## APPLICATION OF NEW CONSTRUCTION GUIDELINES

In retrofit situations, the ADA requires that new construction guidelines be followed to the maximum extent feasible, if compliance with the new construction guidelines is technically infeasible. The determination of technical infeasibility will vary depending on the scope of the project and the existing situation.

The new construction guidelines, as described in the previous section, should be applied as much as possible given the constraints of the project and the site.

The following sections provide guidance to assist the engineer/designer in understanding the effect of varying locations and different actuation on the usability of the information provided by APS.

## AVOIDING AMBIGUITY

The goal of the new construction location requirements and guidelines is to provide unambiguous information about which crosswalk has the WALK indication, and to make pushbuttons accessible to and usable by all pedestrians, including those with visual and mobility impairments. Poor location and installation can render APS unusable by a pedestrian who is blind or mobility impaired or can provide dangerously incorrect information.

Pedhead-mounted and pushbutton-integrated APS in the U.S. have typically been mounted on the same pole as the pedestrian signals for that crosswalk, regardless of whether the pedhead is the one closest to that crosswalk. This does not always provide unambiguous audible WALK indications.

In Australia and some European countries, it is common to install a separate stub pole to mount APS in a consistent location in relation to crosswalks. This consistent location makes it easy to determine which device the WALK indication is coming from, and, therefore, provides unambiguous information regarding which crosswalk has the WALK interval. Draft PROWAG implements this strategy in new construction in the U.S.

## ISSUES TO CONSIDER

In designing retrofit installations, an understanding of the effect of certain intersection features on APS use will be helpful in making decisions. Another factor that becomes critical when adding APS to an existing intersection is the location of existing poles and the possible need for new poles to position the APS close to the crosswalk. Details on these issues and recommended solutions are given in the following sections.

# Needs Assessment

## STRATEGIES

After an engineering study determines that APS should be installed at an existing signal, strategies for integrating the APS into the sidewalk environment need to address certain issues and/or questions. Those in charge of installing APS at an intersection must conduct a needs assessment to determine which features are suitable in order to develop detailed installation plans. It is important that the installation designer visit the intersection to understand the particular issues that must be dealt with. Some manufacturers require detailed information about the location and infrastructure of the intersection where the APS will be installed in order to send equipment with appropriate arrows or other features (such as speech WALK or pushbutton information messages, if needed).

## PUSHBUTTON AND POLE LOCATIONS

A high-priority part of the needs assessment is to determine how much of the existing infrastructure can be used and how much will have to be installed or modified. It is essential to look at each crossing and the anticipated location of the pushbutton in relation to the departure location.

Questions to consider:

- Does the pushbutton and pole location fit within MUTCD and Draft PROWAG recommended locations?
- Is existing wiring adequate for installation of the APS? The manufacturer's devices may have different wiring needs. Some require four wires to be available at the pushbutton where others require two wires. There may be different requirements where audible beaconing is used.
- Is it possible to separate the pushbuttons for two crossings on the same corner by at least 3 m (10 feet)?
- Is the speaker closer to the crosswalk it signals than it is to the other crosswalk?
- Are the pushbuttons located adjacent to a level all-weather surface, free of hazards or obstacles?
- Is there sufficient turning room for a wheelchair if the pedestrian must turn to push the button and then return to the crosswalk?
- If the existing pole is in a "poor" location, can a stub pole be installed? Or, are there other poles nearby that are more appropriately located than the signal pole (e.g., utility poles or lamp posts)?
- Depending upon the pushbutton or pole location, should tones or speech messages be utilized? (if two pushbuttons must be installed on the same pole, speech messages should be used for the WALK indication)

## **INTERSECTION GEOMETRY AND NEED FOR AUDIBLE BEACONING**

Audible beaoning is not needed at many intersections, although APS in the United States have traditionally been installed with beaoning.

Questions to consider:

- Is audible beaoning needed at the intersection? (See discussion of audible beaoning in chapter 4 for suggested criteria)
- Would audible beaoning create the potential for confusion? (possible at an intersection with channelized right turns or other free flowing lanes)

## **PREFERENCE AND REQUESTS**

Questions to consider when installation is in response to a request:

- Have the needs of individual requesting the APS been addressed?

## Pole Location

### EXISTING POLE LOCATION

When the only change is addition of APS at an intersection (usually in response to a request), the existing pole location at the intersection often restricts the location of the APS components (such as pushbuttons, speakers, and tactile arrows) which can affect the device features needed.

- The location of pushbuttons and tactile arrows and the location of speakers must be carefully engineered to provide accessible and usable information to pedestrians with disabilities.
- Consideration of these issues in designing the installation and ordering devices is needed to avoid providing ambiguous information. Before ordering devices, the designer needs to look at the poles available and determine locations where devices will be installed.
- Pole location may affect the type of WALK indication to be used.
  - o Location of two APS on one pole requires either speech WALK indications, additional mast arms, or other provisions to separate the sounds.
  - o APS speakers will usually be located at the pushbutton location. In some situations, they may be on the pedhead. The location of these speakers can be critical.

### *Location of the tactile arrow*

**Figure 6-14. If pedestrians proceed directly to the curb from the pushbutton in this photo, they will be well outside the crosswalk area when beginning their crossing.**



If poles are located too far away from the center of the intersection, outside the extension of the crosswalk lines, the pedestrian who is blind may attempt to cross at a location that is not within the crosswalk area. As discussed in chapter 4, pedestrians may align with the tactile arrow and proceed to the curb from that location.

The installation shown in Figure 6-14 is far more than five feet outside the crosswalk lines extended. While the arrow does clarify which street the device controls, it provides misleading and dangerous information to pedestrians who cannot see.

### THREE OPTIONS

If there are no poles at the recommended locations, in retrofit situations, options to consider, in order of decreasing desirability (from the standpoint of minimizing ambiguity), include:

1. Repositioning of pedestrian signals and poles, or the addition of stub pole(s) and associated conduit and wiring
2. Two APS on a pole with speech messages (see Chapter 4 for recommended wording of speech messages)
3. Use of speakers mounted on the pedestrian signal head, possibly with mast arms or other provisions in order to locate the WALK tone speakers as near to the associated crosswalk as possible



**Figure 6-15. Well-located pedestrian signal poles provide APS audible indications from the optimal location, close to the pedestrian waiting area**

## 1. REPOSITIONING PEDESTRIAN SIGNALS AND POLES OR ADDING STUB POLES

Repositioning poles may be considered a major change in some renovation projects, but may be less difficult when the addition of the APS is part of the upgrading of the curb ramp. The optimal choice is positioning speakers and pushbuttons on poles that are located close to the crosswalk. Possible ways to accomplish this should be strongly considered before other options are explored.

In some locations, the addition of stub poles may be fairly simple. Different jurisdictions have different wiring requirements. The wires to pushbuttons are low voltage wires and it may be possible to run the wires in a saw cut to a pushbutton pole that is surface-mounted to the sidewalk with bolts. Looking at the wiring and the use of stub poles in unconventional ways may provide acceptable solutions to the problems.



**Figure 6-16. APS are positioned appropriately at this intersection by the addition of a stub pole for one crosswalk. The stub pole holding the APS for the crosswalk at right is simply bolted to the sidewalk. The other APS is mounted on the pole that supports the pedhead.**

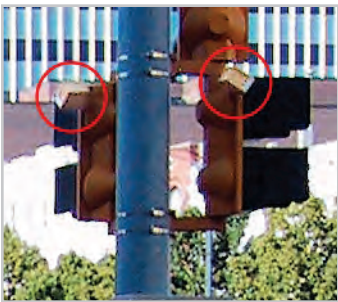


## 2. INSTALLING TWO APS ON ONE POLE

Many jurisdictions use a standard design of two pedestrian signal heads and pushbuttons on one pole. In new or reconstructed intersections, separate poles should be provided at the end of each crosswalk, for the pushbutton to provide unambiguous APS information, and to be maximally useful to all pedestrians. Where two APS pushbuttons are mounted on two separate poles at a corner, their arrows can be readily aligned with each crosswalk. Correct alignment can be difficult to accomplish with two APS on the same pole, particularly at larger radius intersections.

However, if two pushbuttons must be on the same pole, it is essential that speakers be located as close as possible to the pedestrian waiting location and fit the recommendations below for installations of two APS on one pole.

- A speech WALK message is needed, so the user can determine which street has the WALK indication (see discussion of WALK indications in Chapter 4).
- A pushbutton message and tactile arrow are also needed so that pedestrians can know the direction of the crosswalk served by that pushbutton and the name of the street to be crossed. Without the pushbutton message, the name of the street in the WALK message may still be ambiguous to pedestrians who are unfamiliar with the intersection.



**Figure 6-17. Two pedhead-mounted speakers, aimed at right angles to each other are separated by the width of the pedheads and the mounting pole. More distance is preferred and careful aiming and volume control is important.**

## 3. POSITIONING PEDHEAD MOUNTED SPEAKERS NEAR CROSSWALK

If the available pole is not close enough to the crosswalk location, pedhead mounted speakers may be mounted to extend from the pole to provide the appropriate separation of sounds (see Figure 6-4). Provision of the WALK information at the proper crossing location, even when pushbutton and poles cannot be relocated, may provide some auditory guidance to the pedestrian who is blind about the crosswalk location. This type of installation may not provide the best location for tactile arrows and signs, so if a pushbutton is used, the pushbutton should also provide a locator tone and tactile arrow.

In Figure 6-17, the speakers are positioned on the outside of the pedheads, which somewhat separates the sounds, although more separation is preferred. In these photos the speakers are aimed across the street. In most instances, the speakers may be aimed directly down toward the waiting area for communication of the beginning of the WALK phase to the pedestrian who actuated the signal. When audible beaconing is needed, the speaker may be aimed toward the center of the street.

## Specifications

When ordering APS units from the manufacturer, practitioners will need to be specific concerning the features and settings that they desire or require. The level of detail required by the manufacturer varies depending on the company.

Elements of a specification sheet should inform the manufacturer of the characteristics of the location where the APS will be installed and which APS features will be required by the city or state. The following list contains suggested elements for a detailed specification sheet. APS units do not necessarily need to have all these features, but the practitioner should be sure to consider the appropriateness of all features and specify which ones are required for the selected APS installation.

- Type of WALK indication required (tone or speech message)
- Text and name of street if speech WALK indication is used
- Requirement for “extended button press” function and specification as to what this function would need to do (e.g., provide pushbutton information message, provide louder WALK indication, etc.)
- Requirement for vibrotactile arrow
- Requirement for pushbutton information message
- Text for pushbutton information message (if used)
- Requirement for audible, visual, and/or tactile feedback of pushbutton activation
- Orientation of tactile arrow for each unit
- Text to be encoded into Braille for imprinting on pushbutton or informational sign
- Anticipated mounting (wood or metal pole)
- Required location of control unit (ped head or cabinet)
- Required factory settings for
  - o WALK indication volume (minimum and maximum and amount over ambient)
  - o Locator tone volume (minimum and maximum and amount over ambient)
- Electrical operating requirements (e.g., voltage, etc)
- Wiring requirements (e.g., number of wires, gauge)
- Required operating temperature range
- Requirement for built-in WALK/DONT WALK conflict detection
- Warranty duration and coverage
- Follow-up support and assistance available from the manufacturer

It is also useful to include an intersection diagram showing:

- crosswalks to be controlled
- pushbutton locations
- speaker locations and angle (if pedhead-mounted speakers are desired)

## Mounting and Wiring Issues

### LOCATION OF CONTROLLER BOARDS AND WIRING

#### *Wiring*

Pushbutton-integrated APS may require an extra set of wires to the pushbutton to power the audible indications. APS with actuation indicators may need to receive an actual signal from the controller that the call has been accepted. If the conduit is not adequate for extra wiring, plans for installation may require conduit and wiring replacement. However, some manufacturers now provide devices that can replace typical pushbuttons and require only two wires and an additional control unit in the controller cabinet.

Some APS manufactured abroad initially required 110 volt AC power to the push button rather than DC power. These manufacturers now supply APS models to the U.S. market that are adapted to provide DC power to the pushbutton. It may be necessary to specify that devices meet U.S. requirements.

#### *Traffic signal controllers*

APS devices work with current controllers used in the U.S. In installations from 2000–2003, some controller conflicts were reported, mainly related to a change in voltage that leads to the Malfunction Management Unit (MMU) override. These have been addressed by the manufacturers and seem to be resolved. In 2002, the Access Board funded a project to investigate problems that found that many issues that had been reported were due to incorrect installation or sound adjustment problems. The final project report is available on the access board website at [www.access-board.gov](http://www.access-board.gov).

#### *Mounting APS controller boards*

Some APS have a control board that is completely contained within the pushbutton. Other APS require a separate control board that is mounted in the pedhead (see Figure 6-18), while still others require a control unit mounted in the controller cabinet. The control board often includes voice or sound chips and switches to control volume, microphone response and other features.



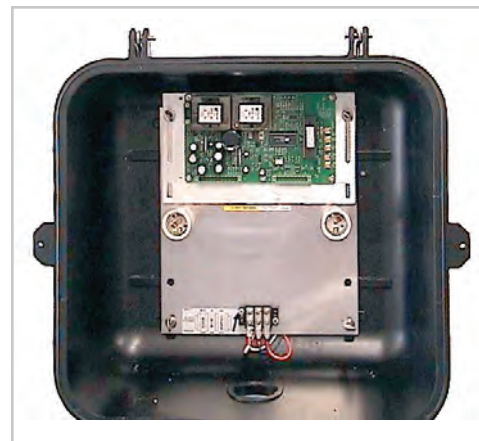
**Figure 6-18. APS device with control board in pedhead-mounted speaker (speaker opened for illustration)**

Some types of pedheads do not have adequate space to mount APS control boards. For example, incandescent, 12 inch over/under pedheads may not have adequate space. These pedestrian signal heads can be replaced. Other options may include:

**Figure 6-19. External mount for controller board is visible on the left side of the pedestrian signal head**



**Figure 6-20. Controller Board mounted inside 18-inch pedestrian signal head**



- Manufacturers may be able to supply a separate case for the APS control board (see Figure 6-19).
- APS control boards may be mounted in the signal controller. However, the correct gauge wires must be calculated to drive the speakers when wiring is extended across the street/intersection. Included wiring is usually only adequate to drive the speakers when run from the pedhead.

**Figure 6-21. APS speaker mounted directly to the metal pole for more support during high wind**



If an area typically experiences high winds, it may be necessary to mount the APS speaker on a strong surface. Engineers in Nova Scotia found that speakers mounted on the plastic pedhead were prone to cracking off during times of high wind. Their solution was to mount the speakers directly to the metal pole, as shown in Figure 6-21.

### *Vibrating surfaces*

Vibration-only devices are not recommended. However, pushbutton-integrated APS should have a vibrotactile arrow that vibrates during the WALK interval. The vibrotactile arrow can be useful in confirming the audible WALK indication and providing WALK signal information to individuals with impaired hearing. Designers/engineers and installers must remember that the vibrating surface will be usable only if they are installed within the width of the crosswalk or very near the crosswalk, and near the curb line. Pedestrians must be in an appropriate position to begin their crossing while waiting with their hand on the vibrating surface.

### *Orientation of tactile arrow*

The tactile arrow must be oriented parallel to the direction of travel on the crosswalk controlled by the pushbutton. Arrows on several manufacturers' devices are positioned by the installer; however, with some devices, the direction of arrow is specified when

ordering the units. The pole location in relation to the crosswalk can affect the direction of the arrow.

### Wooden poles

In areas where pushbuttons are installed on wooden poles, the wiring usually runs within a conduit on the outside of the pole. A mounting bracket is needed on some devices for wiring the pushbutton. This bracket needs to be ordered with the APS.



**Figure 6-22.** The direction of the cast-in-place arrow on this device must be specified when ordering

Pedestrians who are blind have expressed concerns about nails and staples that are common on wooden poles and which present a hazard for their hands when locating the button (see Figure 6-26). Innovative solutions include the use of a shield for the pole area near the pushbutton to solve this problem, as shown in Figure 6-27.

### Stub poles

The use of stub poles for mounting pedestrian pushbuttons is common in some areas of the U.S. They provide an opportunity to locate the pushbutton where it is most usable to pedestrians and may improve pedestrian compliance with pushbutton use.

Stub pole examples

### Braille labels and signs

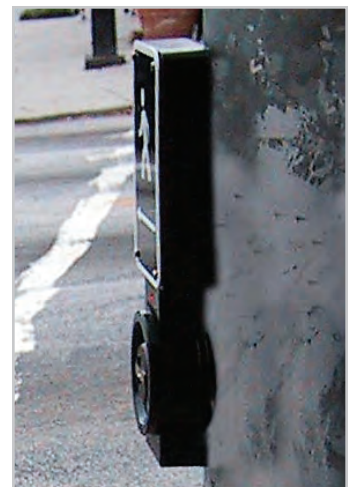
Before ordering APS with Braille labels on the faceplate, you must know:

- The location of the pole, and
- Which side of the pole the APS will be mounted on

The direction of the face plate and associated arrow is determined when the raised dots of Braille are added. Braille is generally just punched into the metal plate.



**Figure 6-23.** Mounted on a wooden pole, an additional mounting bracket is installed to allow the wires to run from the conduit into the top of the pushbutton-integrated device.



**Figure 6-24.** Typical installation without extra mounting plate, with wire running from inside the metal pole into the back of the device

**Figure 6-25.** This APS is mounted on a wooden pole by drilling a hole through the pole and running wires through the back of the device



**Figure 6-26.** Wooden pole with nails and staples that are typical and a source of concern



**Figure 6-27.** Coated canvas shield used in Charlotte, NC



**Figure 6-28.** A stub pole is used to locate the pushbutton beside the sidewalk



**Figure 6-29.** Stub pole example



**Figure 6-30.** Stub pole installed near sidewalk signal box simplifies wiring and locates ped pushbutton by the crosswalk





Figure 6-31. Stub pole example



Figure 6-32. Braille label is below the raised print street name



# APS Microphones and Speakers

## MICROPHONE LOCATION

Some APS require installation of microphones to monitor the ambient sound; this is part of the automatic sound adjustment feature. The microphones measure the sound levels to adjust the volume at the waiting location. If the microphone is mounted too far from the intersection, it will not adequately sample and adjust the volume levels, and the WALK indication is likely to be too quiet for a pedestrian at the curb to hear above the sound of traffic.

## APS SPEAKERS

This Guide focuses on pushbutton-integrated APS, due to the fact that this is the emerging state-of-the-art technology for APS and Draft PROWAG and the Proposed 2009 MUTCD require APS to be integrated with pushbuttons. However, the authors recognize that many agencies may still be using APS that are pedhead-mounted only. Such pedhead-mounted APS are typically equipped with a standard pedestrian pushbutton (not enabled with raised arrow or vibrotactile function) and an overhead speaker which provides an audible indication of when the walk interval begins. Even if an agency is using pushbutton-integrated APS, some manufacturers also provide the option of having a speaker at the pedhead in addition to a speaker at the pushbutton location. This may be particularly useful where audible beaconing is installed, to focus the audible beaconing signal.

There are different issues to be considered for the APS installation design, depending on the speaker location. The following sections will provide guidance for each of the two general speaker locations.

## PUSHBUTTON-INTEGRATED SPEAKERS

### *Sound dispersion from pushbutton-integrated speakers*

While the speaker is usually built into the pushbutton-integrated device, different devices have slightly different speaker locations, and this affects the volume settings and the mounting of the device.

If possible, particularly in a location with audible beaconing, the devices should have speakers oriented toward the street, as well as the sidewalk and pedestrian waiting location. Beaconing is unlikely to be successful when provided by a device without speaker openings on the curb side. The addition of a pedhead-mounted speaker may need to be considered in a situation requiring beaconing. Some manufacturers sell optional add-on speakers or baffles to control direction of sound, when needed.



**Figure 6-33. Speaker grille on side of APS**



**Figure 6-34. Speaker grille on front and side of APS**

### *H-frame for pushbuttons*

An H-frame is used for mounting pushbuttons in some northwestern states. Some APS devices will not work properly when mounted in this configuration. The type of device and location of speaker components should be considered before ordering. The arrow of the APS is often part of the pushbutton and may not be oriented properly in the H-frame. In addition, the design of the frame makes it difficult to hear the sound of the locator tone from both the approach direction and the crossing direction.

It can be helpful for pedestrians who are blind to hear the locator tone as they complete their street crossings (the WALK indication is seldom still sounding by that time). In this type of mounting, the pushbutton locator tone is not audible from the street because the speaker is aimed back toward the building line.

If two pushbutton-integrated APS in H-frames are mounted on a single pole, they will provide ambiguous WALK indications because the APS closest to each crosswalk will be indicating the perpendicular crosswalk, not the closest crosswalk.

The speaker for the locator tone in Figure 6-36 is oriented toward the building line, rather than toward the street (in the location shown in the photo, the WALK indication comes from an overhead speaker). One of the arrows points toward the pole and the other device, as well as toward the street, but it would be hard to use the arrow for direction when standing on the sidewalk side of the pole.



**Figure 6-35. Example of H-frame pushbutton**

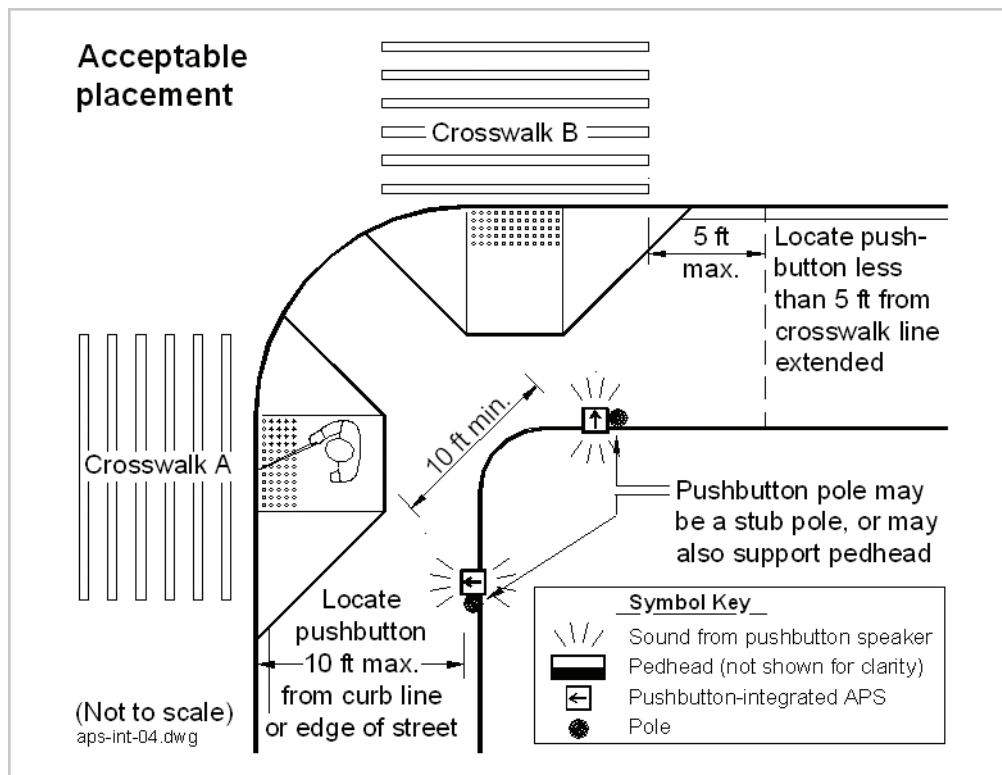
### *Illustrations of ideal, acceptable, and unacceptable locations of pushbutton-integrated devices and speakers*

The drawings on the following pages illustrate proper and improper positioning of pushbutton-integrated devices and speakers. In the following captions, “retrofit” refers to the installation of APS at existing intersections. A retrofit might involve some constraints on the installation process, such as the inability to have two separate poles on a single corner. It is assumed that the sidewalk beside the pushbutton is firm and level as required by Draft PROWAG.

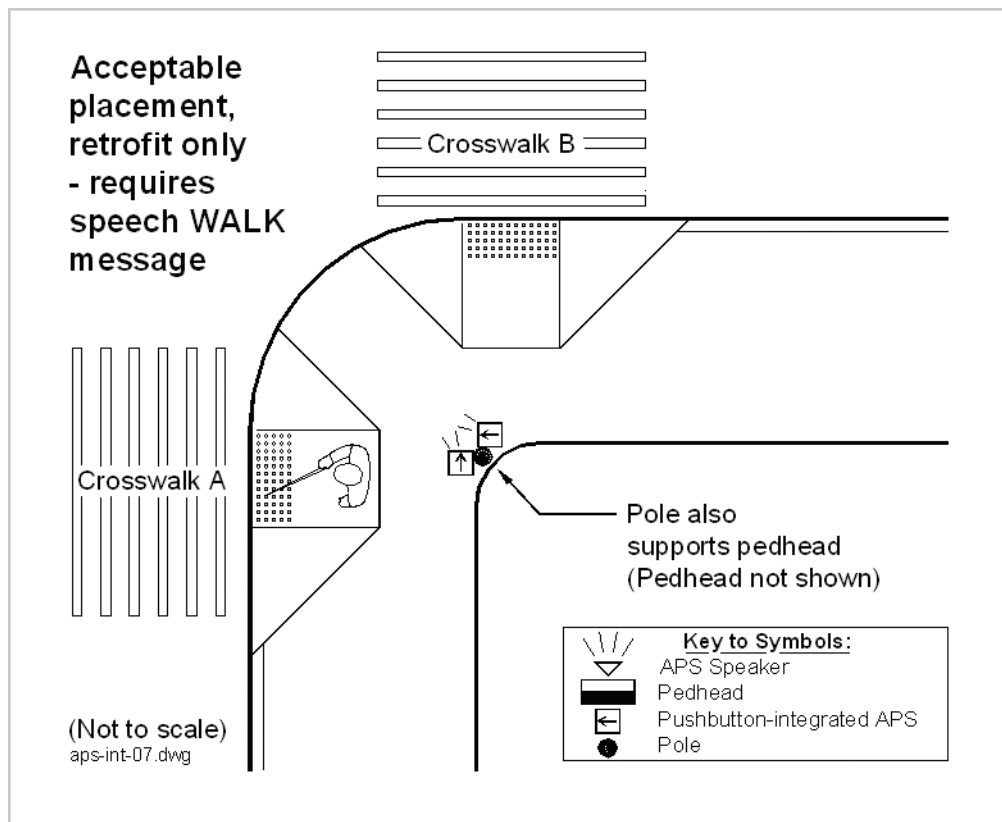


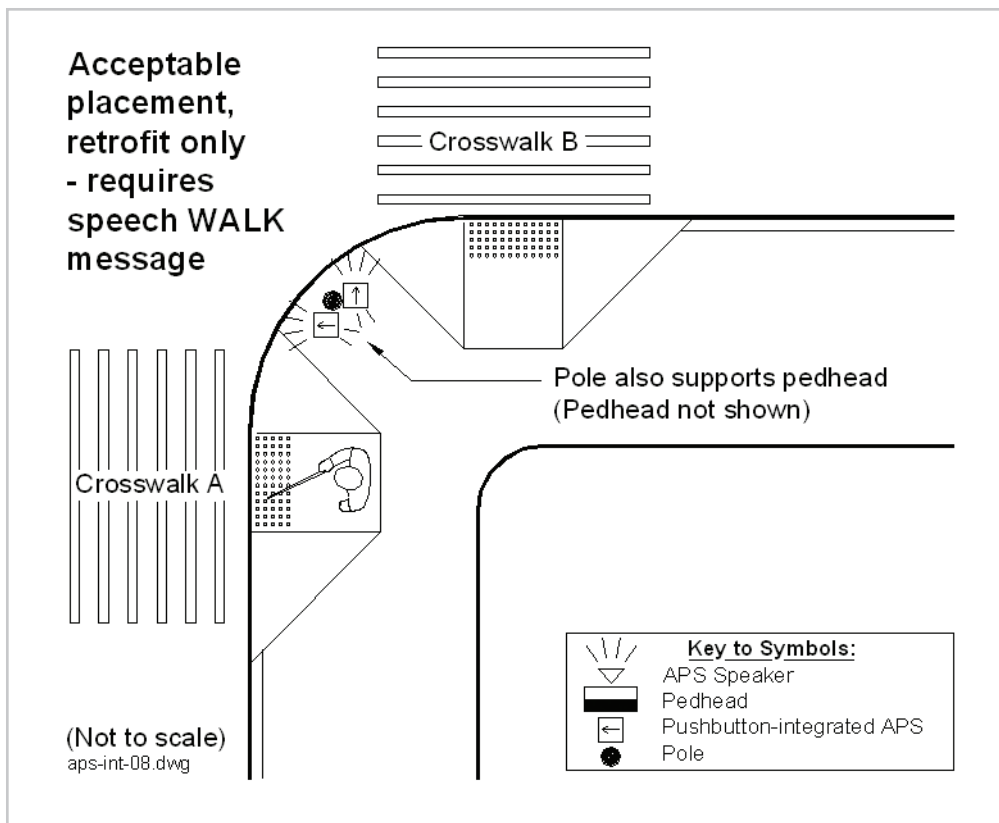
**Figure 6-36. H-frame APS mounted to pole**

**Figure 6-38. Acceptable placement for pushbutton-integrated APS**

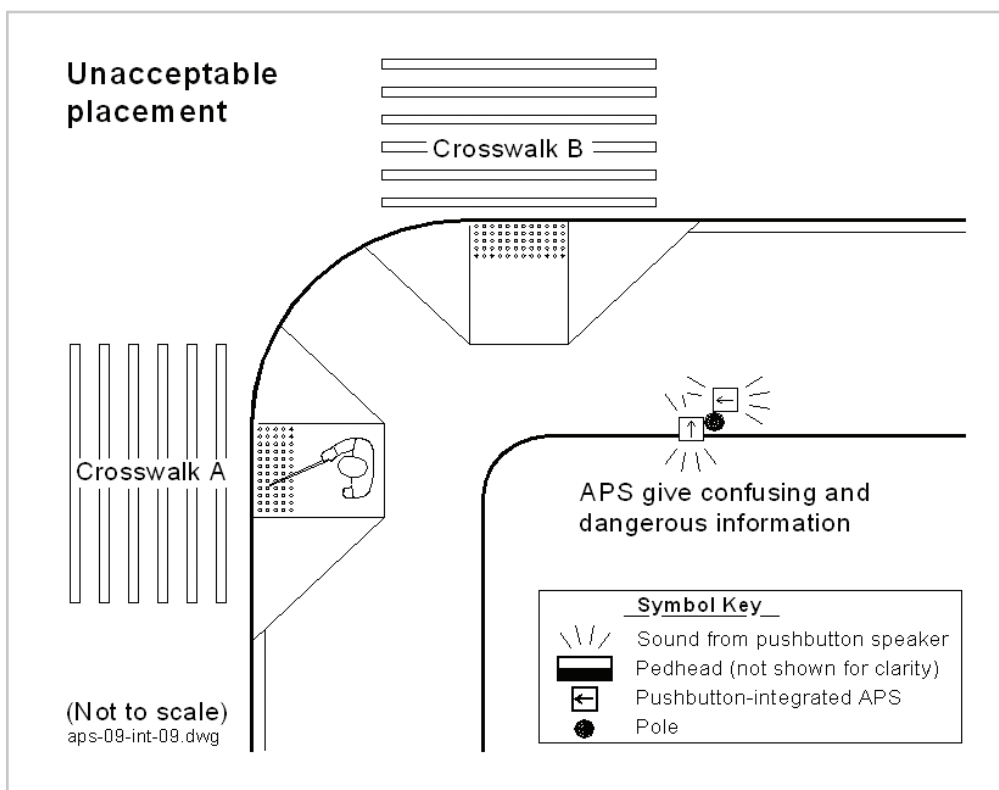


**Figure 6-39. Acceptable placement for pushbutton-integrated APS, only when installing in a retrofit situation on an existing pole (if APS cannot be separated, there will need to be a speech pushbutton information message and speech WALK message to prevent ambiguity)**



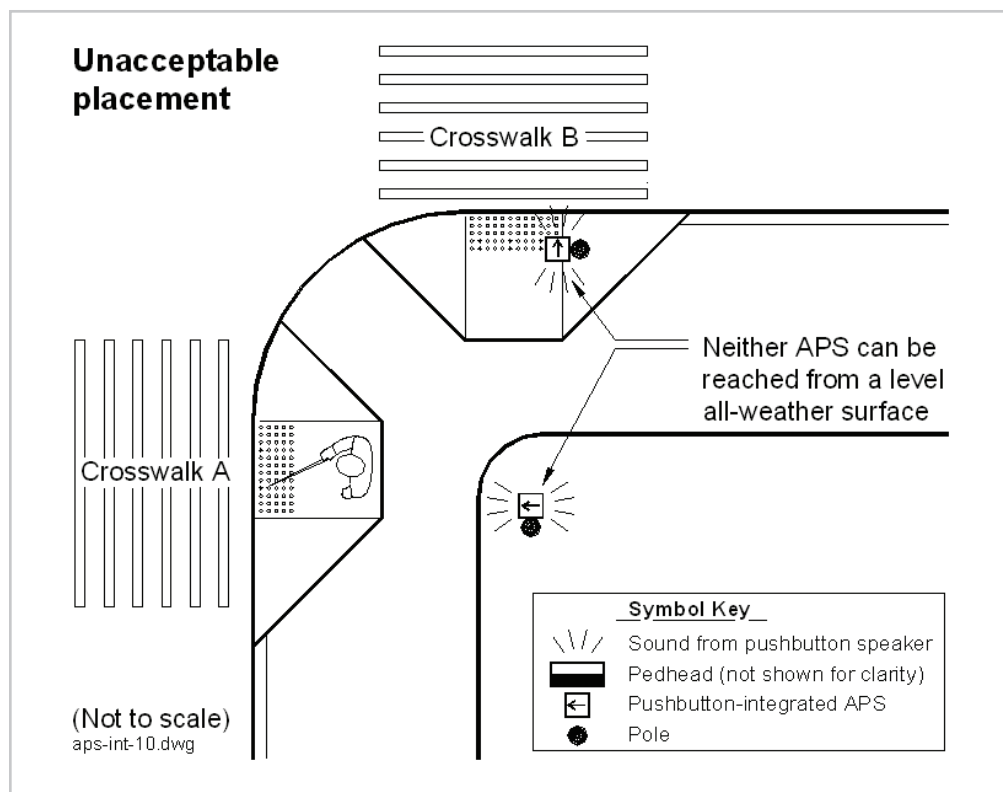


**Figure 6-40. Acceptable placement for pushbutton-integrated APS, only when installing in a retrofit situation on an existing pole (if APS cannot be separated, there will need to be a speech pushbutton information message and WALK message to prevent ambiguity). Additionally, the face of the APS does not face the intersection, as is required in the Proposed 2009 MUTCD.**



**Figure 6-41. Unacceptable placement for APS speakers (the positioning provides ambiguous information)**

**Figure 6-42. Unacceptable placement for pushbuttons and tactile arrows of APS (not reachable from level all-weather surface)**



## PEDHEAD-MOUNTED SPEAKERS

### *Sound from pedhead-mounted speakers*

**Figure 6-43. This photo shows a view from below of a speaker attached to the pedhead support and aimed straight down**



The sound from pedhead-mounted speakers is not very useful for providing guidance about the location of the opposite curb. Unless audible beaconing is required, speakers should be aimed down toward the pedestrian waiting location.

Speakers may be aimed toward the center of the street at crosswalks where beaconing is needed. For pedhead-mounted speakers, sound will travel farther the more nearly horizontal the radiation pattern of the speaker is.

- Where beaconing is not needed, speakers should be pointed down toward the location of pedestrians waiting to cross the associated crosswalk, which will also minimize noise in neighborhoods.
- Where beaconing is needed, the speaker must be pointed toward the middle of the associated crosswalk (centerline of the road). A side effect of this design is that the APS will produce more noise in the neighborhood.

### Speaker location

While the direction of the speaker does make a difference, it is common for overhead speakers that are attached to pedheads to provide ambiguous information. Figure 6-44 illustrates such a speaker and pedhead placement. In both cases, the mounting is problematic because the speakers are mounted on a pedhead that is not over the departure location of the crosswalk they signal.

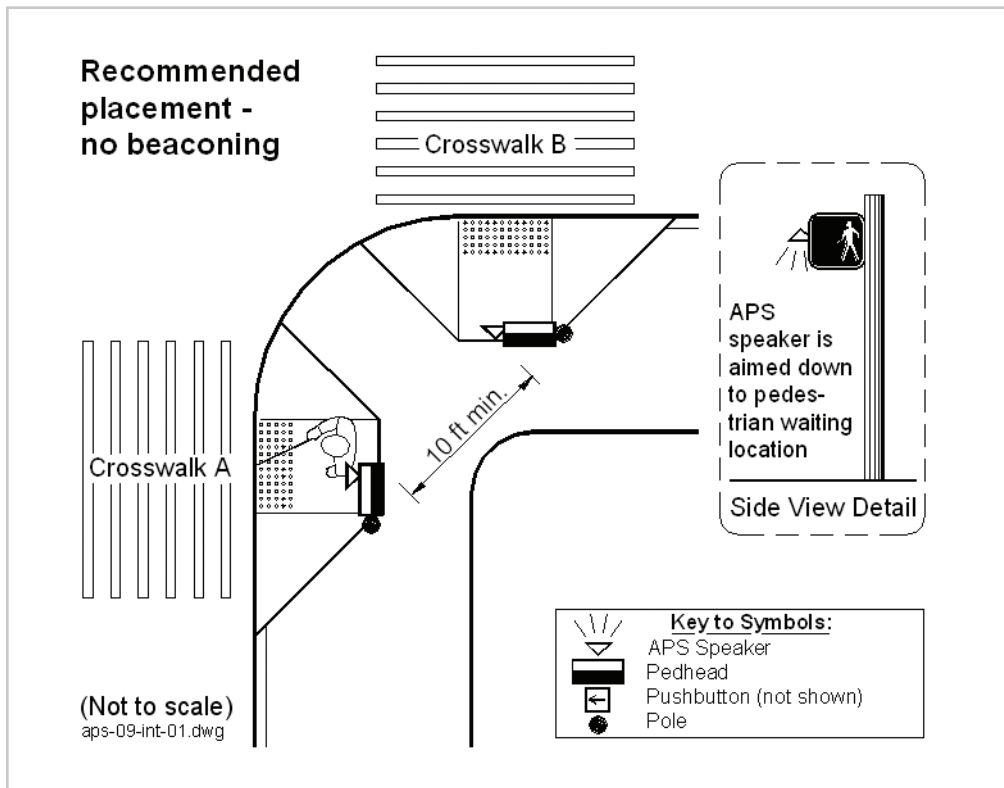
The speaker in Figure 6-44 is located on the side of the pedhead and sounds for the north/south crosswalk. It is situated directly over the waiting area to cross to the east and some distance from the north/south departure point. This configuration can be very confusing to pedestrians who are blind.



**Figure 6-44.** The pedhead and APS speaker for the north/south crosswalk is located over the pushbutton for the east/west crosswalk

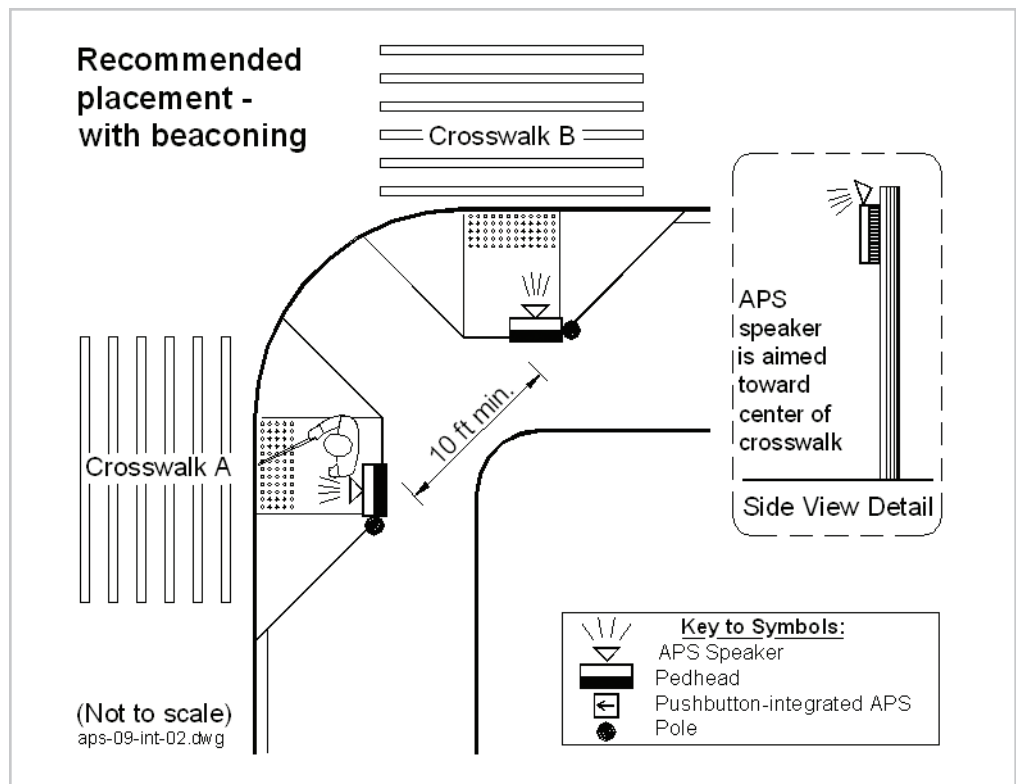
### Acceptable and Unacceptable Locations of pedhead-mounted speakers

The drawings on the following pages illustrate proper and improper positioning of pedhead-mounted devices and speakers.

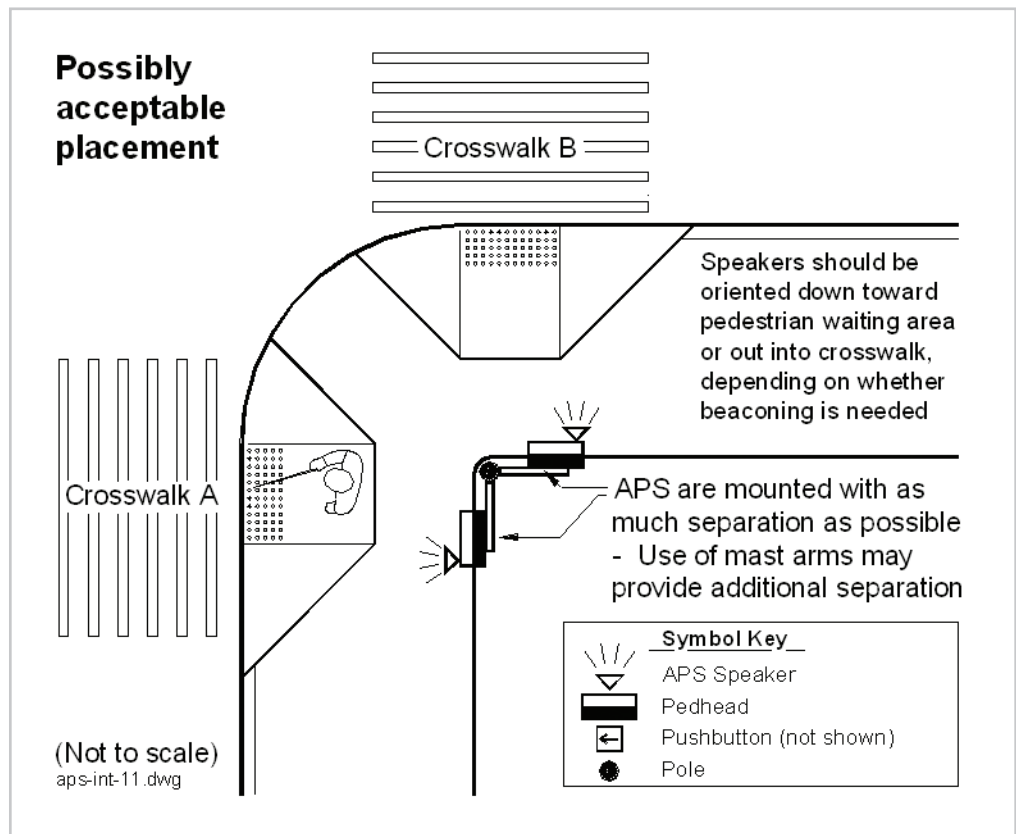


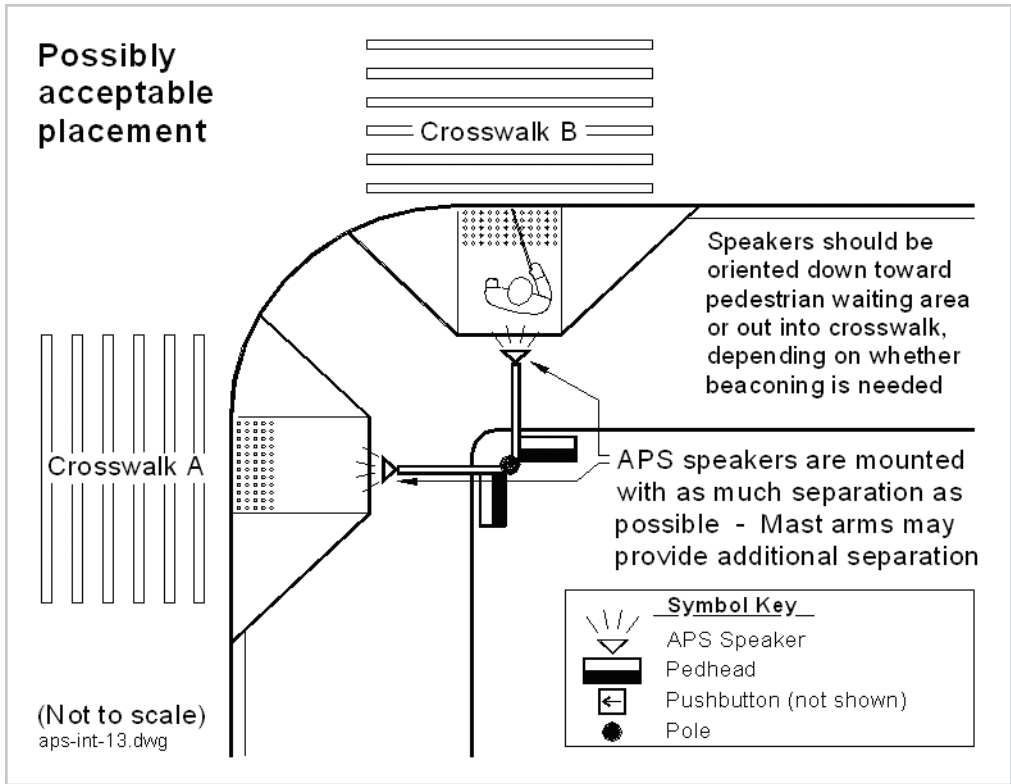
**Figure 6-45.** Possible placement for APS speakers mounted on the pedestrian signal head at pretimed signals; no beaconing

**Figure 6-46. Recommended placement for pedhead-mounted speakers where beaoning is needed**

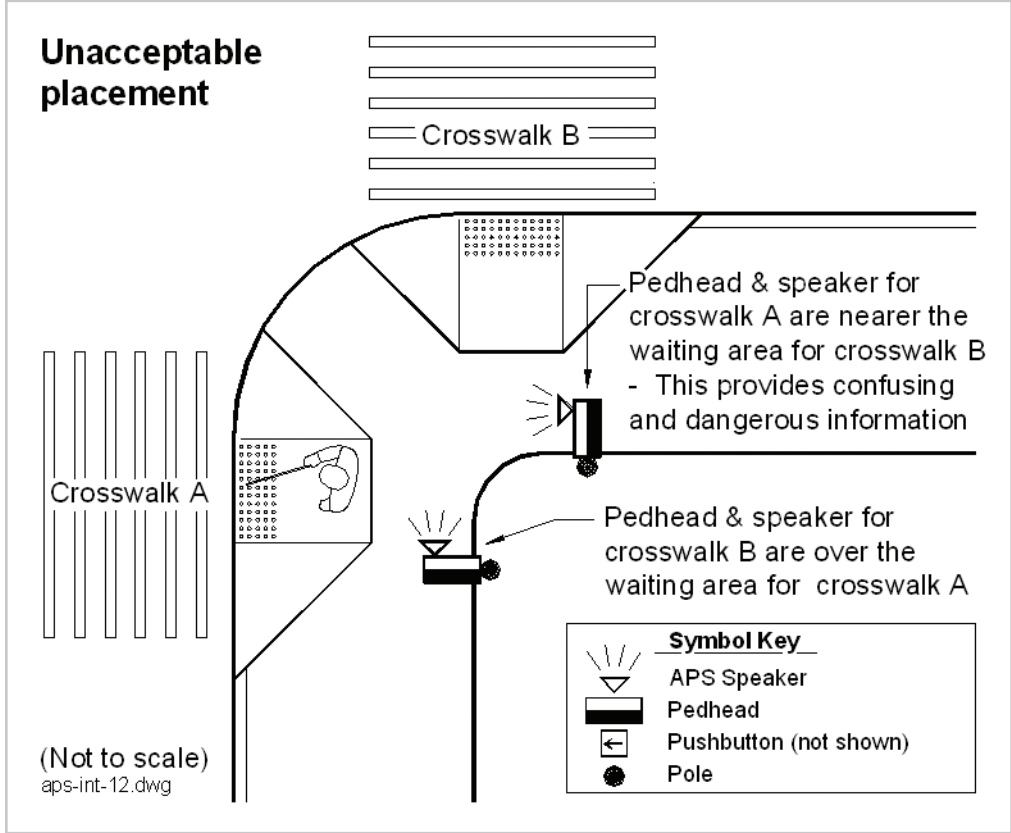


**Figure 6-47. Possibly acceptable placement for pedhead-mounted APS on the outside of the pedheads. Provide as much separation as possible.**





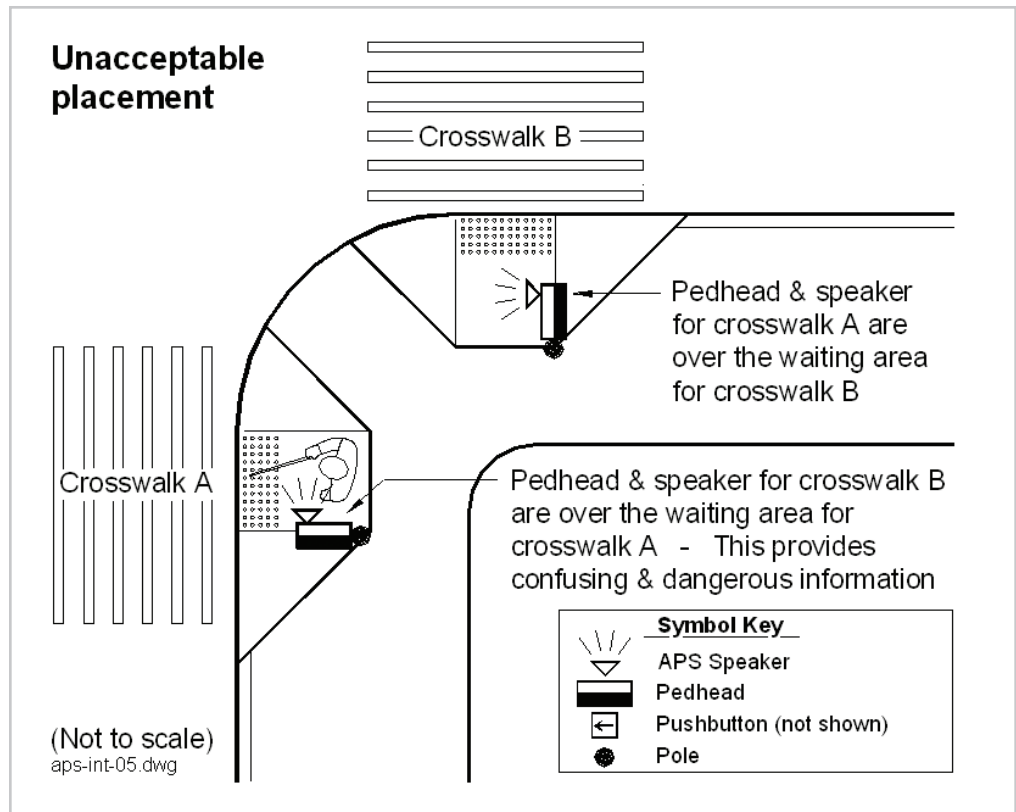
**Figure 6-48. Possibly acceptable placement for pedhead-mounted APS using mast arms to provide additional separation**



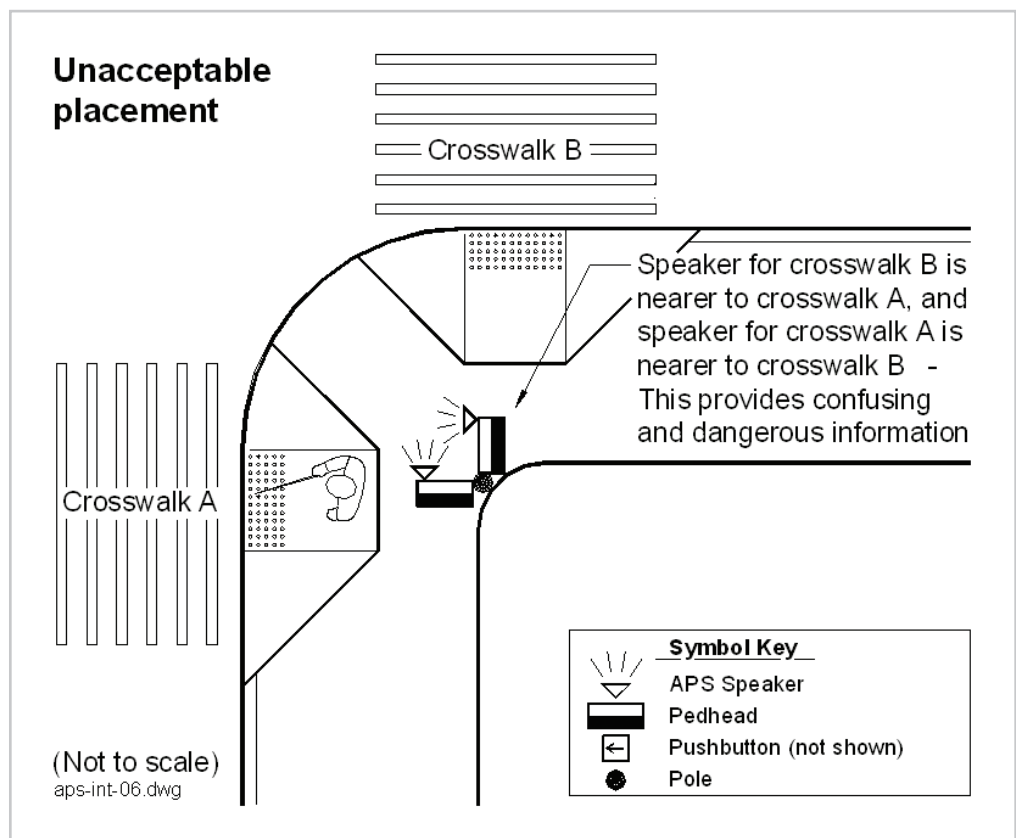
**Figure 6-49. Unacceptable placement for pedhead-mounted speakers, regardless of how speakers are aimed**



**Figure 6-50. These APS speaker placements are unacceptable, regardless of how speakers are aimed**



**Figure 6-51. These APS placements are unacceptable, regardless of how speakers are aimed**



# Summary of Recommended Features and Installation Practice

## APS INSTALLATION IN NEW CONSTRUCTION

### *Recommended features*

- Rapid tick WALK indication, no more than 2-5dBA above ambient sound
- Vibrotactile WALK indication
- Speaker and vibrotactile indication located at pushbutton
- Pushbutton locator tone
- Tactile arrow on each device aligned in direction of travel on the crosswalk
- Braille or audible street name

### *Recommended installation*

- Precise location of the APS is very important to prevent ambiguity about which crosswalk is being signaled
- APS should be reachable from the level landing of the curb ramp for the crossing or from a level surface with an accessible path to the ramp
- APS should be within 5 feet of the extension of the crosswalk lines and within 10 feet of the curb
- Tactile arrow should be aligned with the direction of travel on the crosswalk
- Face of the device oriented toward the intersection (APS should be located on the intersection side of the pole)
- The APS on the same corner should be a minimum of 3 m (10 ft) apart
- Pushbutton should be located within reach range for wheelchair users

## APS INSTALLATION AT EXISTING LOCATIONS (NOT NEW CONSTRUCTION)

New construction guidelines should be met to the maximum extent feasible.

- Pushbutton-integrated APS must be located close to the crosswalk (see Optimal APS Location, pages 6-4 through 6-8)
- If it is not possible to mount two APS on the same corner a minimum of 10 feet apart, an APS providing a speech message during the walk interval, as well as a pushbutton message, is recommended
- If a pedhead-mounted APS speaker is used, it must be above the waiting location of the crosswalk being signaled (see Pedhead-mounted speakers, pages 6-52 through 6-61)

## CONFIGURATION-SPECIFIC RECOMMENDATIONS

Below are listed some specific situations in which there are installation recommendations in addition to the ones listed above for new construction and existing construction. The recommendations listed for each situation below are only the areas where they differ from the general recommendations listed above. Unless otherwise specified, all other above recommendations apply to each situation.

### *APS installations where beaconing is needed*

APS at intersections where beaconing is needed should have certain features and installation, whether they are used in connection with pretimed or actuated signals.

- Loud locator tone during the flashing DONT WALK of the subsequent pedestrian phase only, in response to an extended button press, from speakers at the pushbutton or pedestrian signal head. If mounted high, speakers should be aimed diagonally down and out into the center of crosswalk indicated by that APS. If possible, beaconing sound should come from the far side speaker only (this requires special equipment and wiring).
- Sound should be increased only for the requested crosswalk
- Location of all speaker components of the APS within the width of the crosswalk is essential, as users will direct their travel toward the source of the sound (see Figures 6-46 through 6-51 for example drawings)

### *APS at pretimed intersections where beaconing is not needed (not new construction)*

- If pushbutton-integrated APS cannot be located at the pedestrian waiting area, pedhead-mounted APS (which do not provide vibrotactile indications) must be above the waiting location of the crosswalk being signaled and should be aimed down toward the waiting location

### *APS at corners where two pushbuttons must be mounted on the same pole (not new construction)*

- Speech WALK indication, two to five dBA above ambient sound
- Pushbutton information message to provide intersection and crosswalk identification information
- Speech messages should follow the recommendations for wording, and the APS should be positioned within 10 feet of the curb (see page 6-29 and Figures 6-39, 6-40, 6-41, 6-47, and 6-48)



**Figure 6-52. Example of pushbutton information messages and speech WALK messages for two APS located on the same pole**



# Chapter 7:

## Installation, Operation, and Maintenance

### CHAPTER SUMMARY

This chapter provides guidance for signal technicians who will work directly on the installation of the APS units. In many places, this chapter refers to Chapter 6 illustrations, so readers should have access to both chapters. Lessons learned from project research are included.

### CHAPTER CONTENTS

Review of Design Guidance .....	136
Installation .....	139
Adjustments .....	144
Setting and evaluating sound levels .....	145
Post-installation checklist .....	149
Maintenance .....	152
Lessons Learned from APS Installations .....	154

# Review of Design Guidance

## CURRENT GUIDANCE

The MUTCD Section 4E.06 recommends: “The installation of accessible pedestrian signals at signalized intersections should be based on an engineering study, which should consider the following factors:

- Potential demand for accessible pedestrian signals.
- A request for accessible pedestrian signals.
- Traffic volumes during times when pedestrians might be present; including periods of low traffic volumes or high turn-on-red volumes.
- The complexity of traffic signal phasing.
- The complexity of intersection geometry.”

Draft PROWAG requires audible and vibrotactile indications of the WALK interval when new pedestrian signals are installed.

## PRINCIPLES

The following guiding principles should be kept in mind when installing APS. The APS installation should:

- Provide pedestrian signal information to those who cannot see the pedestrian signal head across the street
- Provide information to pedestrians about the presence and location of pushbuttons, if pressing a button is required to actuate pedestrian timing
- Provide unambiguous information about the WALK indication as well as which crossing is being signaled
- Use audible beaconing only where necessary
- Put as little additional sound in the environment as possible to avoid disturbance of neighbors and allow pedestrians who are blind or visually impaired to hear the traffic sounds, as well as the APS

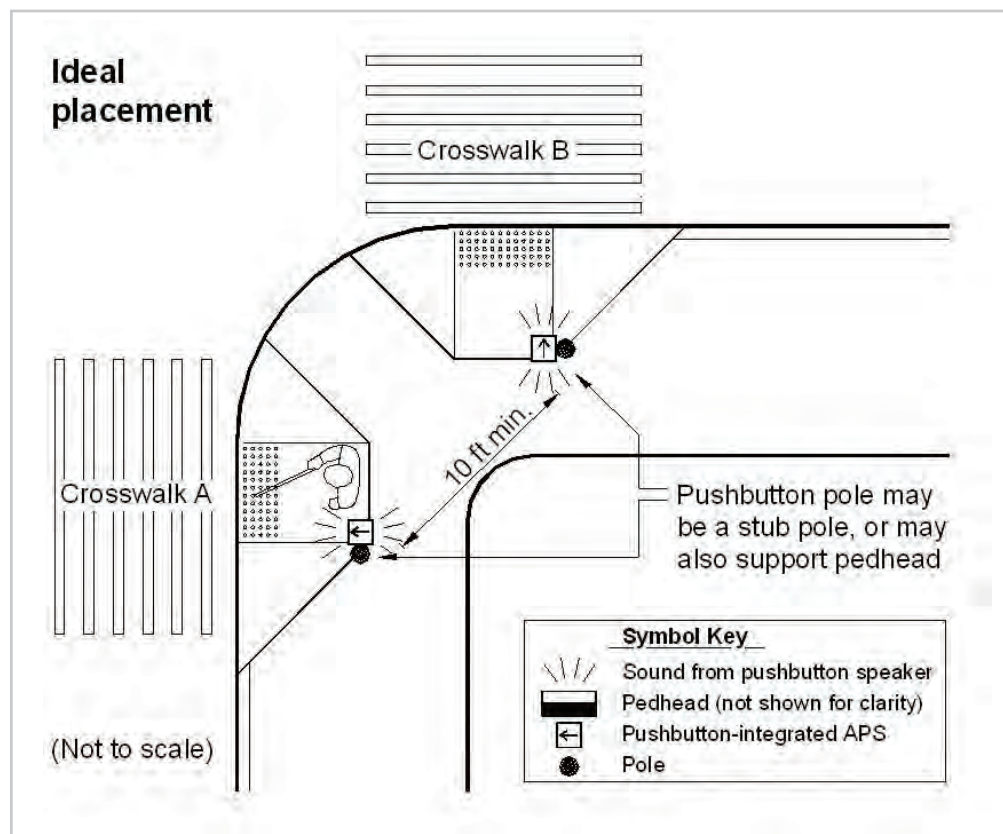
## NEW CONSTRUCTION — IDEAL INSTALLATION

Providing audible and vibrotactile indications of the WALK interval, as specified in Draft PROWAG, means that devices should be integrated into a pushbutton unit, in order to provide vibrotactile WALK indications. The vibrotactile feature is usually a tactile arrow incorporated into the pushbutton device.

The ideal location for pushbutton-integrated APS is between the edge of the crosswalk line (extended onto the sidewalk) farthest from the center of the

intersection and the side of the curb ramp. If at all possible, APS should be between 1.5 feet and 6 feet from the edge of the curb, shoulder, or pavement. However, in order to provide wheelchair access to the pushbutton, the pushbuttons must be located adjacent to a level all-weather surface. The control face and tactile arrow should be carefully aligned with the direction of travel on the associated crosswalk.

At corners of signalized locations where two pedestrian pushbuttons are provided, the pushbuttons should be separated by a distance of at least 10 feet (see Figure 7-1). A rapid tick WALK indication is recommended for installations following these guidelines about location.



**Figure 7-1. Ideal placement for pushbutton-integrated APS in the top corner of the flare of the curb ramp, next to the level landing**

## RETROFIT INSTALLATION – CONSTRAINTS AND ACCEPTABLE SOLUTIONS

Many APS installations will be a retrofit situation where they are being installed at an existing signalized intersection that is not being completely reconstructed. There will likely be infrastructure constraints that will make an ideal installation difficult.

### *Poles not located at ideal positions*

If there are no poles at the recommended locations, options that should be considered, in order of decreasing desirability and from the standpoint of ambiguity, include:

- Repositioning of the pedestrian signals and poles, or the addition of stub pole(s) and associated conduit and wiring



- Two APS on a single pole with speech messages for the WALK indication, and additional features required with speech messages
- Use of pedhead-mounted speakers, possibly with mast arms or another provision in order to locate the WALK indication speakers as near to the associated crosswalk as possible

# Installation

## WIRING

Wiring needs and availability should be considered before ordering devices because some devices and features require additional wires between the pedestrian signal head, the pushbutton, and the controller. APS typically require an additional control board in the pedestrian signal head or in the controller cabinet.

Manufacturer's instructions should be reviewed, as wiring may be more complex than expected due to additional features such as the vibrotactile WALK indication (vibrating surface) and additional messages or tones. Other potential wiring issues are as follows:

- May need wire in addition to what is provided with the APS
- Wire types may range from phone type wire to stranded wire
- APS that require four wires may need to have extra wiring installed at the pushbutton poles.
- Some manufacturers provide a 2-wire APS model that uses the existing wiring from previously installed standard pushbuttons. For that installation a control unit is installed in the controller cabinet. Wiring this device requires correct connection of wires from pedestrian signal heads, particularly where two parallel crosswalk do not operate concurrently to provide accurate messages. In addition, replacing standard pushbuttons with APS may not be as easy as it appears. In some cases, new holes will have to be drilled and the APS mounted in a correct position if the previous pushbutton was not positioned correctly (e.g., previous pushbutton angled toward center of intersection instead of parallel to crosswalk).
- APS that provide audible beaconing from the far side only (opposite end of crosswalk from where button was pressed) may require additional wiring to provide the proper signals between the pedestrian signal and controller for the beaconing.

### *APS control units*

As mentioned above, APS often have control units that must be installed in the pedhead or in the traffic signal controller. An example of a control board being installed in the pedhead is shown in Figure 7-2. As can be seen in the photo, the technician found that a bungee cord was helpful in holding the pedhead lens while he was installing and adjusting the APS control unit. Additional photos and information on control units can be found in Chapter 6 in "Mounting and Wiring Issues."

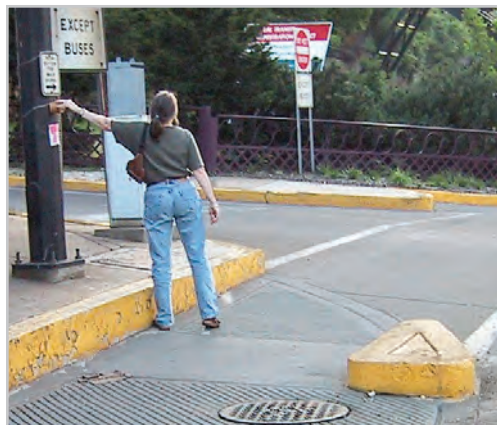


**Figure 7-2. Technician installing APS control board in pedhead**

## Traffic signal controllers

As stated earlier, APS devices work with current controllers used in the U.S. While Malfunction Management Unit (MMU) problems seem to have been solved by manufacturers, functioning of the intersection and devices should be carefully checked after installation.

**Figure 7-3.** This pushbutton may be 42 inches from the bottom of the pole, but it is almost 60 inches above the landing, not accessible to a wheelchair user and not likely to be located by a person who is blind.



**Figure 7-4.** Not only is the pushbutton in the bushes and out of reach range from the sidewalk, construction barriers have been stored against the pole, preventing all pedestrians from reaching the pushbuttons.



## PUSHBUTTONS, TACTILE ARROWS, VIBRATING SURFACES AND SIGNS

### Height of pushbuttons

The pushbutton must be within accessible reach range of a level landing for use from a wheelchair and MUTCD specifies 42 inches as mounting height. The MUTCD requirement of 42 inches is well within the reach ranges specified by Draft PROWAG.

Draft PROWAG (306.2.2) requires APS pushbuttons to be installed within specified reach ranges of the curb ramp landing, or of a level surface with an accessible path to the curb ramp. A level surface is defined as a surface with less than 2% slope in any direction. This allows a person in a wheelchair to push the button without having to hold the wheelchair steady on a slope.

Reach ranges in ADA guidelines are described as forward reach or side reach and unobstructed or obstructed. Forward or side reach refers to the position in relation to a level surface and whether the pushbutton can be approached from the directly (forward) or must be approached from the side. Obstructed or unobstructed describes whether the wheelchair can be pulled immediately next to the pushbutton mounting surface or whether an obstruction, such as a wall, pole base, or an uneven or dirt surface, must be reached over in order to reach the pushbutton from a wheelchair.

Reach depths (distance from level surface) are specified at 25 inches maximum for forward reach and 24 inches maximum for side reach. For forward or side reach, unobstructed, Draft PROWAG allows the pushbutton to be mounted between 15 in and 48 in above the level surface. Obstructed high reach varies depending on the depth of the obstacle, but is in a range of 42 to 46 inches.

Locations that are “convenient” to the installer may not be usable by all pedestrians.

## *Vibrating surfaces*

Vibrotactile WALK indication should be provided during the associated WALK interval by each APS equipped with a vibrating surface. The vibrating surface (arrow) will be usable only if it is installed within the width of the crosswalk or very near the crosswalk, and near the curb line. Pedestrians must be able to wait to cross while keeping a hand on the vibrating surface.

When two APS pushbuttons with vibrotactile indications are installed on the same pole, they may require insulation and a rubber gasket to eliminate vibrations generated from the other pushbutton.

## *Shape and type of mounting pole*

Municipalities in the U.S. use a great variety of poles for mounting pedheads and pushbuttons. When the tactile arrow is part of the pushbutton integrated device, the orientation of the device on the pole determines whether the tactile arrow is aligned with the crosswalk. A new mounting hole may need to be drilled for the pushbutton, in order to be sure the arrow points in the correct direction. A person who is blind may attempt to determine their heading for crossing based on the arrow. The arrow should point toward the destination corner.

Most pushbutton-integrated devices are designed to be installed on round poles. Poles that are not round may require a special mounting bracket or shim to orient the arrow correctly.

## *Location and orientation of tactile arrows*

Before devices were ordered, the pushbutton and tactile arrow (vibrating surface) location should have been determined and specified. Any adjustment from the intended design must be carefully considered. If poles are located too far away from the center of the intersection, outside the extension of the crosswalk lines, the pedestrian who is blind may attempt to cross at a location that is not within the crosswalk area. See an example of a poorly placed pole in Figure 6-14 in Chapter 6. Pushbuttons should be within reach from a level landing, within 5 feet of the crosswalk lines extended and within 10 feet of the curb. Specifications on pushbutton location are provided in Chapter 6.

The tactile arrow must be oriented parallel to the direction of travel on the crosswalk controlled by the pushbutton. It may be helpful to stand behind the unit and look across the street to check the orientation before and after installation. The arrow should point to a location within the crosswalk along the opposite curb. Arrows on several manufacturers' devices can be turned or repositioned by the installer. However, with some devices, the direction of arrow is specified when ordering the units. Pole location in relation to the crosswalk can affect the arrow direction.



**Figure 7-5. Well-located APS on a square pole.**



**Figure 7-6. A mounting bracket or shim is needed on this square pole to orient the arrow properly. Without it, the arrow points to the center of the intersection.**



**Figure 7-7. APS is misaligned with the arrow pointing into the bushes.**

Where speech messages are used for the WALK indication or where there is a pushbutton information message, installer should check that arrow direction and speech messages agree. APS have accidentally been installed with the message providing notification about the wrong street.

The fluted pole in Figure 7-7 made correct alignment more difficult. The installer said he had to put it that way because he did not have any shims. The specifications given to the manufacturer for this unit should have included shims to allow for the necessary angle adjustment.

### *Wooden poles*

In areas where pushbuttons are installed on wooden poles, the wiring usually runs in a conduit on the outside of the pole. A mounting bracket, which needs to be ordered with the APS, is needed on some devices for wiring the pushbutton. Other options are discussed in Chapter 6 in “Mounting and Wiring Issues.”



**Figure 7-8. At this location, the faceplate was mounted backwards, with the Braille indented rather than raised and the small paper label, intended only to translate the Braille, is on the outside rather than the inside.**

### *Braille labels and signs*

The direction of the face plate and associated arrow is determined when the raised dots of braille are added. Braille is generally just punched into the metal plate. Print street names may not be provided on the APS, since print street signs may be available at the intersection already. Typically, the faceplate can be flipped to show a right arrow or a left arrow, and the manufacturer includes a print label on the faceplate to translate the braille for installers so they will install the sign at the appropriate location. The print label should be installed on the inside of the faceplate (facing the pole), not on the outside (see Figure 7-8). If the braille sign has been installed correctly, the braille dots will be raised to the touch after installation.

## **APS MICROPHONES AND SPEAKERS**

### *Microphone location*

Microphones should be mounted as near as possible to the pedestrian waiting location. If the microphone is mounted too far away, it will not adequately sample and adjust the volume levels resulting in a WALK indication that is too quiet for a pedestrian to hear above the sound of traffic.

### *APS speakers*

Depending on the manufacturer and installation configuration, speakers for APS might be mounted on the pedhead or located in the pushbutton unit. Speakers should be ideally located in the pushbutton, but some agencies might make use of overhead speakers mounted on the pedhead. There are different issues to be considered, depending on the speaker location. If possible, APS devices should have speakers oriented toward the street as well as the sidewalk and pedestrian waiting

location. In locations with audible beaconing, a speaker oriented toward the middle of the crosswalk is needed. The addition of a pedhead-mounted speaker may need to be considered in that situation; some manufacturers sell optional add-on speakers. One manufacturer provides baffles to better control the direction of sound.

An H-frame is used for mounting pushbuttons in some northwestern states. However, the design of the frame makes it difficult to hear the sound of the locator tone from both the approach direction and the crossing direction.

### *Sound from pedhead-mounted speakers*

If the APS configuration uses pedhead-mounted speakers, the aim of the speakers is important. Unless audible beaconing is needed, speakers should be aimed down toward the pedestrian waiting location. Speakers may be aimed toward the center of the street at crosswalks where audible beaconing is needed.

## **INSTALLATION OF SPEAKERS AND MICROPHONES**

### *Confirming speaker location and orientation*

Speaker location and orientation need to be checked against the specifications. Installers should make no change in speaker location or orientation without checking with the responsible signal engineer. Poorly located speakers can result in:

- Ambiguous information about which crosswalk has the WALK interval;
- Failure of blind pedestrians to begin or end crossings within the crosswalk; and
- Veering of blind pedestrians outside the crosswalk, possibly into conflicting traffic.

See discussion and examples in Chapter 6 for more information on the effects of speaker location and orientation.

### *Speaker location*

Incorrect speaker location can make a difference in ability of pedestrians who are visually impaired or blind to discern which APS is sounding.

- Each APS speaker at a corner must always be closest to the crosswalk it signals.
- For pedhead-mounted APS, speakers should not be automatically located on the pedhead that signals the same crosswalk. The pedhead closest to one crosswalk may signal the perpendicular crosswalk. In this case, speakers must be mounted on the pedhead for the perpendicular crosswalk.

### *Speaker orientation*

The speakers should be adjusted so the pushbutton locator tone can be heard by a pedestrian approaching the corner from both the sidewalk side and the street.

However, it is most critical that the WALK indication can be heard at the beginning of the crosswalk.

Precise orientation of the APS speaker is especially critical at locations with audible beaconing. If a speaker or transmitter is oriented out of alignment with the associated crosswalk, pedestrians may inadvertently travel out of the crosswalk, perhaps into the path of vehicular traffic.

Pedhead-mounted speakers in existing installations are often mounted in positions that make the messages more ambiguous. See more information on correct mounting of pedhead speakers in Chapter 6 in “APS Microphones and Speakers.”

For pushbutton integrated devices, the speaker is in the pushbutton housing. Location of the pushbutton and orientation of the speaker can be critical to hearing the WALK indication at the crosswalk. If the speaker is located too far from the crosswalk location, pedestrians who are blind may not hear the WALK indication.

## Adjustments

### INTRODUCTION

Devices should be carefully adjusted in the field and evaluated after installation to be sure they are working properly from an engineering perspective and from the perspective of pedestrians who are visually impaired.

- If the APS has been added in response to a request from a pedestrian who is blind or visually impaired, that individual should also be involved in evaluation after installation.
- Because installers may be unfamiliar with new types of APS devices, extra supervision and attention will be required during the first few installations by any crew or contractor.
- Even when carefully specified, installations sometimes do not match the specifications because installers do not understand that failure to exactly follow specifications may lead to an installation that cannot be accessed by pedestrians who use wheelchairs, or that could cause a pedestrian who is blind to push the wrong pushbutton, to veer into the center of the intersection, or mistake which crosswalk has the WALK interval and start crossing at an unsafe time.

The sound level of the speakers must be carefully set and evaluated at the time of installation, and then checked at a time with different traffic volumes to assure that settings are correct. It is better to install APS with volumes that may be too low and adjust upwards as needed. If volumes are set too high initially, problems can arise with neighboring residents and businesses that can lead to the removal of the APS and difficulties for future installations.

## Setting and evaluating sound levels

### HOW TO ADJUST APS SOUND LEVELS

The controls to adjust the settings of the APS vary among the different manufacturers. The settings may be adjusted by:

- Screws on control board, which may be mounted in pedhead or in the APS speaker unit.
- Remote handheld device, using infrared communication, that must be held in close range to the APS

### Settings

Most devices require setting:

- Microphone sensitivity or automatic gain control (AGC) sensitivity,
- Volume of the pushbutton locator tone, and
- Volume of the WALK indication.

The microphone sensitivity or AGC controls how the other tones/message volumes respond to ambient noise levels. The setting must be adjusted by the installer to provide output at one of a number of ranges between the maximum and minimum. The number and width of ranges varies by manufacturer.

### How loud should the sound be?

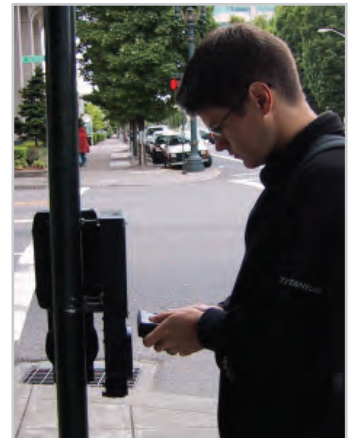
In general, installers have a tendency to set volume levels of devices too loud. Loud overhead audible signals have been problematic to neighbors of APS installations.

In addition, the loud sound of the signal may prevent pedestrians who are visually impaired from:

- Hearing critical traffic sounds used for alignment
- Determining that cars have stopped
- Hearing cars that may be turning across their path
- Localizing on the signal source

Installers should set volume levels according to the following guidance:

- The WALK indicator must be audible from the beginning of the associated crosswalk (MUTCD 4E.06 Standard).
- The MUTCD (4E.06 and 4E.09 Guidance) states that the locator tone and WALK tone of an APS should be at the same volume (except by special actuation, providing a louder tone for a single pedestrian phase) and specifies that the locator tone should be audible 6 to 12 feet from the pushbutton, or to the building line, whichever is less.



**Figure 7-9. Resetting APS settings with handheld device supplied by manufacturer**



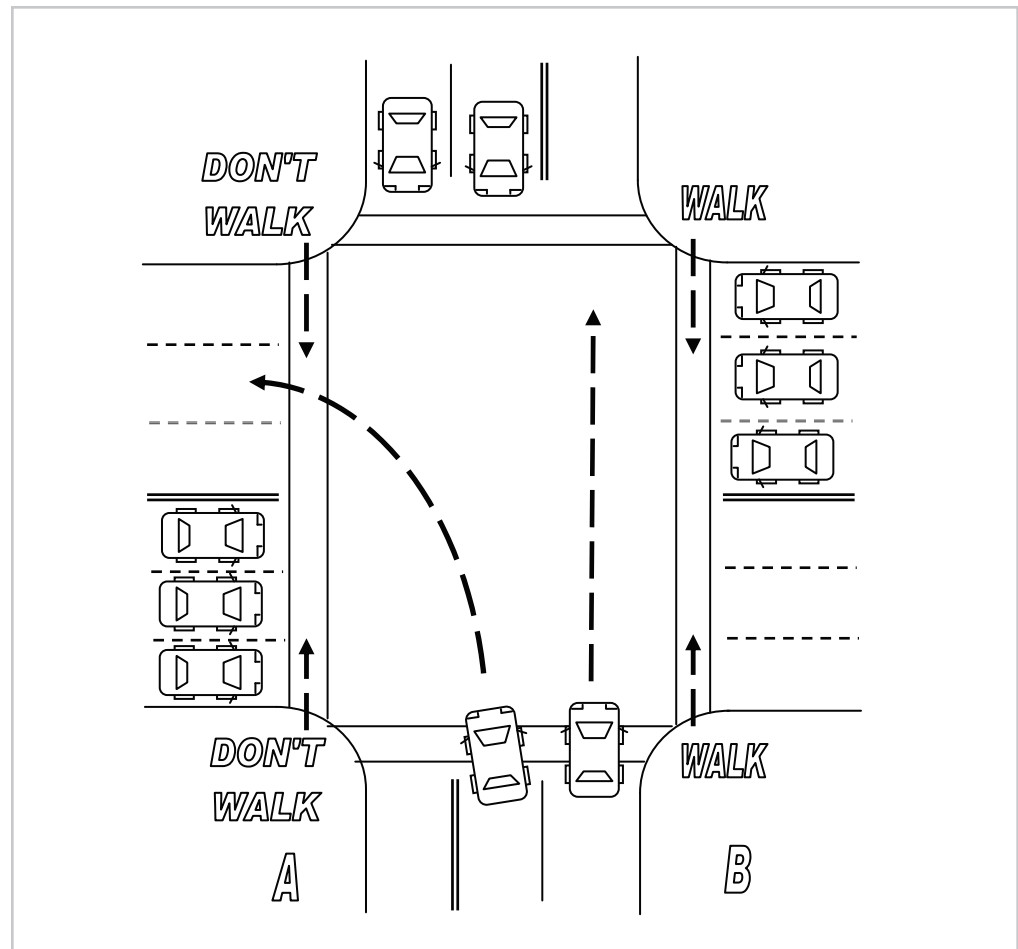
- Manufacturers typically set a default maximum and minimum output level on APS devices. The settings should be checked to ensure that it is set for 30 dB minimum and 89 dB maximum.
- At no time should sound be more than 5 dB above ambient sound (except by special actuation for audible beaconing). Draft PROWAG specifies that the sound level should be between 2 and 5 dBA above ambient sound. [MUTCD 4E.06 and 4E.09 Guidance; and Draft PROWAG 2.5.2.2 G]

### Volume level considerations

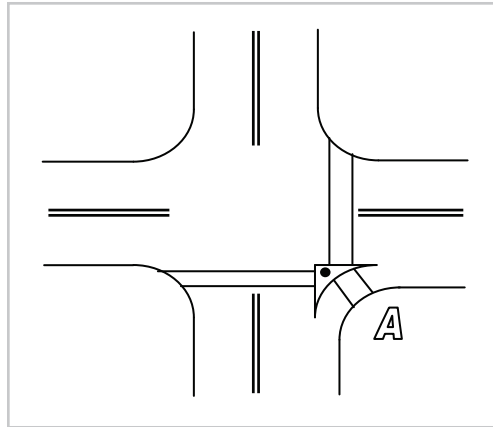
The correct setting will vary depending on whether there are buildings close to the APS, split phasing, or slip lanes.

- When buildings are close to the APS, the sound reflected from the buildings will make the sound seem louder. The reflected sound may also influence the microphone and automatic gain control such that the APS will sound louder for the same setting than if the APS was in an open area.
- At intersections having split phasing, APS at parallel crosswalks must not be audible across the street (at the other parallel crosswalk), or users may begin crossing with the wrong WALK signal. Check this at times of low ambient sound as well as at times with normal sound. In Figure 7-10, the APS giving the WALK indication on corner B should not be heard by someone standing on corner A.

**Figure 7-10. Illustration of pedestrian signals at an intersection with split phasing**



- APS at intersections having channelized turn lanes must not be audible from the corners of the intersection. If an APS on the splitter island is too loud, pedestrians who are blind may believe the turn lane is signalized, or that the intersection crosswalk extends all the way to the corner. If the volume is too loud, pedestrians might assume that they have a WALK indication to begin crossing, when, in fact, they may be entering an uncontrolled slip lane, yield or stop sign controlled slip lane, or a separately signalized turn lane. In Figure 7-11, a pedestrian standing on the corner at location A should not be able to easily hear an APS that is located on the splitter island.



**Figure 7-11. Channelized turn lane illustration**

### *Automatic volume adjustment*

Pre-set automatic volume adjustment or automatic gain controls cannot assure that the volume meets the criterion for distance at which the APS should be audible. Similar automatic volume adjustment settings on APS by different manufacturers may seem to provide quite different loudness, as judged by listeners.

- Automatic volume adjustment technology used by different manufacturers varies in the rate of sampling of ambient sound and in the speed with which output adjusts to changes in ambient sound.
- Some APS and some installations will be more subject to responding to their own noise than others. For example, as the WALK signal continues throughout the WALK interval, the signal may get louder and louder in response to its own noise.
- Different tones or speech will seem louder or quieter depending on their frequency content, although they may measure the same on the dBA scale.

### *Measuring the sound level*

Due to the short duration of pushbutton locator tone and WALK tone pulses, conventional analog or digital sound level meters are not able, in the crosswalk environment, to accurately measure the absolute sound level (dBA) of APS tones, or the sound level of APS tones relative to ambient sound.

At present, setting and evaluation of APS sound level is typically done by ear. There can be errors in making the sound too quiet or too loud. It is critical for the WALK indication to be loud enough to be audible at the crosswalk waiting location. Both the locator tone and WALK indication should be audible within 10 to 12 feet of the device, but not more than that. It has been the authors' experience that many APS installations have been set louder than was optimal either for blind pedestrians or APS neighbors.

## *Measuring sound where audible beaconing is needed*

At crosswalks where audible beaconing is needed, sound level should be evaluated from the middle of the street, when the loud WALK indication has been called, to be sure beaconing will be provided throughout the crossing. However, current MUTCD language limits the maximum output of APS to 89dB, and most manufacturers pre-set this maximum. Therefore, at exceptionally wide crossings, and when and where there is high ambient sound, there may be a distance in the middle of the crosswalk where the beaconing is not readily heard. Changes to the MUTCD limits have been recommended by NCUTCD and may be incorporated into the 2009 edition.

## *Microphone location and effect on perceived loudness*

APS devices that respond to ambient sound have microphones to pick up the ambient sound.

- Microphones for pedhead type devices are typically in or on the pedhead, incorporated into the APS.
- Pushbutton integrated devices may have microphones at the pedhead or the microphones may be incorporated into the pushbutton housing

An APS microphone should be mounted as close as possible to the position of the pedestrian who is waiting to cross the associated crosswalk, because sound pressure is halved for each doubling of the distance from the sound source in a free field.

The farther from that ideal position the microphone is for a given APS device, the greater will be the following problems.

- The ambient traffic sound when a microphone is located on a signal pole 10 feet from the curb line will be quieter at the microphone than at the street; therefore the resulting output will be quieter than it would be if the ambient sound were measured near the street.
- The WALK indication, if it comes from the same pole location, may already be too quiet because the ambient sound level has been measured too far from waiting pedestrians, and it will be quieter still when its sound reaches the ears of pedestrians waiting at the crosswalk because the sound has traveled farther to reach them.
- If the microphone is closer to the intersecting street than to the street the pedestrian is waiting to cross, or the microphone is oriented toward the intersecting street, it will respond to the traffic sound on that street instead of the street the pedestrian is waiting to cross. This may result in WALK signals that are too loud or too quiet as perceived by pedestrians waiting to cross.

## *Ideal microphone location*

The best location for the microphone is as close as possible to the position of pedestrians who are waiting to cross the associated street. This results in pedestrians being clearly able to hear APS signals with no need to set the automatic volume adjustment so high that sound levels will be too high or that APS neighbors will be annoyed.

## Post-installation checklist

### CHECKLIST

After installation is complete, the installer should perform the following steps (detailed in sections below). A printable checklist can be found in Figure 7-12.

- Evaluate and adjust the locator tone volume
- Evaluate and adjust the WALK indication volume
- Evaluate and set the sensitivity level of the automatic volume adjustment
- Confirm proper functioning of the WALK indicators
- Check height and location of pushbutton
- Check the tactile arrow
- Check optional features
- Check audible beaconing
- Recheck the functioning at a later time

### LOCATOR TONE VOLUME

Evaluate and adjust locator tone volume

- Approach intersection along sidewalk from both directions and note when the pushbutton locator tone is audible. If there are two pushbutton locator tones at the corner, each should be audible. The pushbutton locator tone should be audible when 6 to 12 feet from pushbutton, or at the building line, whichever is closer to the pushbutton.
- Approach corner from crosswalk and note when the pushbutton locator tone is audible. The pushbutton locator tone should be audible at 6 to 12 feet (or approximately one lane) from pushbutton.
- Listen through several cycles at times when traffic is noisy and at times when traffic is quiet.
- Adjust the locator tone volume as necessary.

### WALK INDICATION VOLUME

Evaluate and adjust the volume of the WALK indication:

- Stand at the curb or end of the curb ramp at the crosswalk and listen for the WALK indication. It should be audible from the crossing location.
- Confirm that the WALK indication for each crosswalk sounds closer than the WALK indication for the perpendicular crosswalk.
- Listen through several cycles at times when traffic is noisy and at times when traffic is quiet.
- Adjust the WALK indication volume as necessary.

## **AUTOMATIC VOLUME ADJUSTMENT**

Evaluate and set the sensitivity level of the automatic volume adjustment:

- If volumes are adequate in quiet conditions, but do not increase enough or quickly enough when ambient noise increases, the microphone sensitivity, or automatic gain control, may need to be increased.
- Increase the microphone sensitivity in 10-20% steps until the response is as desired.
- It might be necessary to readjust the volume of the locator tone and WALK indications after the microphone is adjusted.

## **CONFIRM PROPER FUNCTIONING OF THE WALK INDICATION**

Determine if the vibrating surface, speech messages or other features of the WALK indication work properly:

- Press the button and wait for the WALK indication. The tactile arrow or vibrating surface should vibrate rapidly only during the WALK.
- The WALK indication (tone or speech message) should sound for the duration of the WALK interval, unless there is a special setting due to a “rest-in-WALK” situation.
- If the WALK indication is a speech message, confirm that it refers to the correct street and is appropriately worded and understandable.

## **CHECK HEIGHT AND LOCATION OF THE PUSHBUTTON**

Confirm that pushbutton height and location conform to specifications and can be reached by a person in a wheelchair, from a level landing.

## **CHECK TACTILE ARROW**

Examine the tactile arrow.

- Check that it is aligned in the direction of travel on the crosswalk.
- Confirm that it points to the street that is controlled by that pushbutton.

## **CHECK OPTIONAL FEATURES**

Confirm that optional features, if ordered, are present and functioning correctly.

- Confirm that Braille dots are raised to the touch, not depressed. If possible, request that a person who reads Braille confirm that it is the correct label.
- Press the pushbutton for an extended button press and see if the pushbutton information message plays and accurately identifies the crossing controlled by the pushbutton, and that other information, if provided, is accurate.
- Confirm that a tactile map accurately represents the crossing features.

## CHECK AUDIBLE BEACONING

If the intersection requires audible beaoning,

- Press the pushbutton for an extended button press and confirm that the sound is boosted during the following pedestrian phase for the WALK tone and for the locator tone.
- Walk across the street during the pedestrian phase and evaluate placement and aim of devices to provide sound in the crosswalk area.

## RE-CHECK DEVICE FUNCTIONING AT A LATER TIME

Follow-up during the first few weeks after installation, checking device and volume at different times of day to assure proper functioning.

Designate a person and phone number to call and report malfunctioning devices. Share that information with agencies serving individuals who are blind and organizations of individuals who are blind in the community.

<b>APS Post-Installation Checklist</b>	APS 1	APS 2	APS 3	APS 4	APS 5	APS 6	APS 7	APS 8
Evaluate and adjust the locator tone volume	<input type="checkbox"/>	<input type="checkbox"/>	<input type="checkbox"/>	<input type="checkbox"/>	<input type="checkbox"/>	<input type="checkbox"/>	<input type="checkbox"/>	<input type="checkbox"/>
Evaluate and adjust the WALK indication volume	<input type="checkbox"/>	<input type="checkbox"/>	<input type="checkbox"/>	<input type="checkbox"/>	<input type="checkbox"/>	<input type="checkbox"/>	<input type="checkbox"/>	<input type="checkbox"/>
<b>Evaluate and set the sensitivity level of the automatic volume adjustment</b>	<input type="checkbox"/>	<input type="checkbox"/>	<input type="checkbox"/>	<input type="checkbox"/>	<input type="checkbox"/>	<input type="checkbox"/>	<input type="checkbox"/>	<input type="checkbox"/>
Confirm proper functioning of the WALK indicators	<input type="checkbox"/>	<input type="checkbox"/>	<input type="checkbox"/>	<input type="checkbox"/>	<input type="checkbox"/>	<input type="checkbox"/>	<input type="checkbox"/>	<input type="checkbox"/>
Check height and location of pushbutton	<input type="checkbox"/>	<input type="checkbox"/>	<input type="checkbox"/>	<input type="checkbox"/>	<input type="checkbox"/>	<input type="checkbox"/>	<input type="checkbox"/>	<input type="checkbox"/>
Check the tactile arrow	<input type="checkbox"/>	<input type="checkbox"/>	<input type="checkbox"/>	<input type="checkbox"/>	<input type="checkbox"/>	<input type="checkbox"/>	<input type="checkbox"/>	<input type="checkbox"/>
Check optional features	<input type="checkbox"/>	<input type="checkbox"/>	<input type="checkbox"/>	<input type="checkbox"/>	<input type="checkbox"/>	<input type="checkbox"/>	<input type="checkbox"/>	<input type="checkbox"/>
Check audible beaoning	<input type="checkbox"/>	<input type="checkbox"/>	<input type="checkbox"/>	<input type="checkbox"/>	<input type="checkbox"/>	<input type="checkbox"/>	<input type="checkbox"/>	<input type="checkbox"/>
Recheck the functioning at a later time	<input type="checkbox"/>	<input type="checkbox"/>	<input type="checkbox"/>	<input type="checkbox"/>	<input type="checkbox"/>	<input type="checkbox"/>	<input type="checkbox"/>	<input type="checkbox"/>

**Figure 7-12. APS Post-Installation Checklist**

## Maintenance

### WHEN AND HOW OFTEN THE APS INSTALLATION SHOULD BE CHECKED

As with any complex device, an APS has many features that could malfunction or fail in the course of its operation. If features such as WALK indication, locator tone, or signal interaction fail to work correctly, the resulting lack of information or misinformation for pedestrians who are blind can be dangerous. It is important that municipalities who have taken steps to install these devices also take steps to ensure correct functioning through the years.

The overseeing agency should conduct an audit or checkup of the APS installations on a regular basis. Checkups should be conducted frequently if factors such as harsh weather may have affected the devices. At the very least, the APS should be checked:

- Every 6 months
- After any repairs to the intersection signals, poles or controller
- After any changes to signal timing

### WHAT SHOULD BE CHECKED

On each regular visit to conduct a checkup of the APS units, the evaluator should recheck **each of the items on the original post-installation checklist** (see previous section). To add more specific items to the list, the following list comprises some of the most common failures that have been observed on installed APS devices. These items should be checked specifically, since some may not be obvious on a cursory glance:

- Vibrating arrow/button: may stop working or have very weak vibration
- WALK indication: tone or speech message may have stopped working or be delayed in sounding after the WALK interval begins
- Raised arrow: may be missing or pointing in the wrong direction
- Pushbutton: may be jammed or malfunctioning
- Ambient noise response: may be slow to respond or have ceased responding at all

### OTHER OPERATION AND MAINTENANCE ISSUES

#### *Repairing an APS after a crash*

It is essential that all maintenance personnel understand the functioning of the APS and consider it during repairs.

One municipality had a problem when the pole of the APS was knocked down in an accident and the repair team replaced the pole with the APS oriented toward the

wrong street (see Figure 7-13). The speech message and arrow did not match up; the speech was saying “WALK sign is on to cross Harford Road” (at the correct time) but the arrow on that device pointed toward Taylor Avenue.

In another instance, an APS was damaged by a car that left the roadway. The APS was just strapped back onto the pole with no attention to the alignment of the tactile arrow. The APS continued to function, but was pointing to the center of the intersection, rather than being aligned with the appropriate crosswalk.



**Figure 7-13. APS was temporarily replaced on the pole, but the tactile arrow points to the center of the intersection, rather than being aligned with the direction of travel on the crosswalk.**



## Lessons Learned from APS Installations

### NEW TECHNOLOGY

Not unlike any new technology, the first installation of new types of APS devices does not always operate flawlessly. There are issues to resolve with some of the devices. In addition, reports from older installations have brought up recurring problems that need to be addressed in installation. All of the issues were easily solvable. The following should provide information to prevent these problems from reoccurring. Some issues include:

- Wiring to pedhead and/controller
- Pushbutton installation
- Signal phasing
- Volume adjustment
- Use and wording of speech messages
- Pushbutton and pole location
- Tactile arrow location and position
- Speaker positioning and volume
- Braille signage and correct installation

### WIRING

Some minor problems have been experienced with wiring and color code.

- Prisma, a Swedish company, uses a European wire color standard. Since this standard is not consistent with the U.S. NEMA color code standards, some wiring problems were created. Care should be taken by installers of these products to be certain the devices are wired correctly.
- Prisma APS have also drawn concern from signal technicians over the voltage (120 VAC) sent to the pushbutton location. Technicians are concerned about pedestrian safety if the pushbutton is damaged or the pushbutton is taken off by a passing vehicle, and a pedestrian comes in contact with the live wires or electrically charged metal pole. Step-down transformers for mounting in the pedhead are provided upon request for U.S. installation.

Other problems may be related to incorrect wiring of the pushbutton units:

- In one location, the technician attached the vibration wire to the speech WALK indication. Instead of the speech WALK indication that was expected, there was a rapid buzzing sound from the unit during the WALK and no vibration of the arrow as expected. This was easily corrected by switching the wires, once the problem was noticed and diagnosed.

- At another location, wires from the parallel crosswalks were switched when attached to the control unit in the controller. Those units were programmed for the extended button press to call audible beaconing on the crosswalk, but the sound came from the APS on the parallel crosswalk, rather than from the other end of the called crosswalk. This problem might lead blind pedestrians to cross the intersection diagonally.

## PUSHBUTTON INSTALLATION AND VIBROTACTILE INDICATION

When two APS pushbuttons with vibrotactile indications are installed on the same pole, they may require insulation and a rubber gasket to eliminate vibrations generated from the other pushbutton.

A problem was experienced when two pushbuttons were on the same pole with no vibratory insulation (Figure 7-14). Pedestrians were unable to determine which pushbutton was vibrating, since it appeared both were. Proper insulation of the pushbutton will prevent this problem from occurring.



**Figure 7-14. Incorrect installation of two APS on a single pole (no vibratory insulation)**

## PHASING

- An installation had a problem when the signals went into flash mode and the APS device remained in WALK mode. This scenario presented an unsafe condition and message for pedestrians. This problem was resolved by correctly wiring the APS device into the controller/signal system so the controller logic and conflict monitor detected and changed the pedheads to the appropriate indications.

## VOLUME ADJUSTMENT

Although current standards call for the APS volume to only be 2 to 5 dB above ambient sound and for the locator tone to be heard from 6 to 12 feet from the pushbutton, volume is often set much louder than that.

- Installers are used to devices using audible beaconing and think that APS are supposed to be loud enough to hear across the street.
- Another issue is that there is no easy way to measure the volume of locator tone and WALK indication, because of the short duration of the tones or messages, the requirement to measure in relation to ambient sound, and the signal's quick response to ambient sound.
- For pushbutton integrated devices, the speaker is in the pushbutton housing. Location of the pushbutton and orientation of the speaker can be critical to hearing the WALK indication at the crosswalk.

One installation experienced a different problem in adjusting the volume of an APS unit.

- They had used the pushbutton control units that install in the cabinet (as opposed to those that install in the pedhead).
- The wiring was too small of a gauge to drive the speaker to provide a loud enough message (compounded by the pole and speaker being more than 10 feet back from the crosswalk).
- Manufacturer’s guidelines and specifications should be followed for proper operation. Speakers can be provided for each control unit.

## **SPEECH MESSAGES**

The speech messages used for the WALK indication, as well as the descriptive pushbutton message, must be understandable.

- Poorly recorded WALK messages, by an individual with a strong accent, made the street names indistinguishable [“Pratt” and “Calvert”].
- Using a standard message, “WALK sign is on” at locations with two pushbuttons on the same pole. A pedestrian waiting to cross, who is unable to see the WALK signal, cannot distinguish which WALK is displayed from that message.
- A speech message that does not have additional information that clarifies which street the pushbutton applies to can be confusing to pedestrians unfamiliar with the intersection. For example, at the intersection of Harford and Taylor Streets, the pushbutton information message said “Harford and Taylor” for all devices. If the pedestrians do not know which street they are facing, the speech WALK message “WALK sign is on for Taylor” is unclear.
- One jurisdiction wanted to use a male voice for one crossing direction and a female voice for the other to distinguish crossing directions and add to the safety of the crossing. Most APS devices provided a male voice only, however, all APS devices use messages recorded on speech chips. A different voice can be specified. Most devices provide self-recording message capabilities now. However, care should be taken to provide clear and understandable messages.
- Speech WALK indications should be in the form, “Maple, WALK sign is on to cross Maple”. Some problems have resulted from using a different message wording.

## **PUSHBUTTON AND POLE LOCATION**

Some problems have been observed in locations of pushbuttons and poles of APS devices:

- Poles that are more than 10 feet from the curb line create real problems for blind pedestrians who must find the pushbutton and then realign to cross the street
- Pushbuttons are often placed in positions that are not reachable from the sidewalk area, or in the bushes, or behind a fence

## TACTILE ARROW AND POSITION

The tactile arrow is supposed to point in the direction of pedestrian travel on the crosswalk and the face of the device is supposed to be parallel to the crosswalk it controls.

### SOME INSTALLATION ISSUES:

- If the pole is in a poor location, the arrow may be pointing at the street and crosswalk direction but may not be within the crosswalk area.
- If installers do not understand the purpose of the arrow, they may install it angled in the wrong direction. For example, if they use the holes from a previous pushbutton, the arrow may be pointing diagonally across the intersection rather than in line with the crosswalk.

## SPEAKER POSITIONING

Pedestrian head mounted speakers in existing installations are often mounted in positions that make the messages more ambiguous. See examples in Chapter 6 in “APS Microphones and Speakers” and also earlier in this chapter.

For pushbutton integrated devices, the speaker is in the pushbutton housing. Location of the pushbutton and orientation of the speaker can be critical to hearing the WALK indication at the crosswalk. If the speaker is located too far from the crosswalk location, pedestrians who are blind may not hear the WALK indication.

As shown in Figure 7-15, the pushbuttons are installed incorrectly, so the APS is too far from the crosswalk it signals and the sound for the other crosswalk at the intersection comes from a speaker that is closer to the crosswalk.

In Figure 7-16, the APS are installed correctly (close to the crosswalk they signal) and provide accurate information through proximity to the crosswalk.



**Figure 7-15. APS pushbuttons installed incorrectly**



**Figure 7-16. APS pushbuttons installed correctly**

## **BRaille SIGNING AND LOCATION**

Braille indications on the pedestrian signals have sometimes been mounted backwards or with the braille label for the wrong street.

- Manufacturers ship them with a label to clarify positioning for non-braille-readers. However, technicians might later make adjustments to the sign and reverse or mix up the braille plaques.
- Adding the braille makes it so the sign cannot be turned around without reversing the braille. The braille must remain raised to the touch. If the original specification was not correct, this limits the arrow direction and location.

# Chapter 8:

## Public Education

### CHAPTER SUMMARY

This chapter provides instruction on methods and materials for appropriate educational information to the public about APS.

### CHAPTER CONTENTS

Need for education .....	160
Providing information to the public .....	161
One page flyer about APS installation .....	162
Specific techniques to be used by pedestrians who are blind at intersections equipped with APS (for Orientation and Mobility specialists) .....	163
Requesting an APS .....	164

## Need for education

### NEW TYPES OF APS

Many people in the U.S. have had no experience with new types of APS. It is important that pedestrians who are blind and sighted have some understanding of the functioning of APS and the various features of the APS installed. In particular, it is important that pedestrians know and understand the difference between the pushbutton locator tone and the WALK indication.

### NEIGHBORS MAY BE MORE SUPPORTIVE IF AWARE OF THE NEED

Individuals who live close to newly-installed APS may not be aware of the usefulness of APS for pedestrians who are visually impaired or elderly. Publicity about the APS in advance and preparation for their installation may result in more neighborhood acceptance. Many individuals are not familiar with pushbutton locator tones and may need an explanation of their use by pedestrians who are blind or who have low vision.

### EDUCATION NEEDS DOCUMENTED BY RESEARCH PROJECT

Research completed as part of NCHRP Project 3-62 indicated that education is needed for blind pedestrians to understand pushbutton locator tones, response to ambient sound, and WALK indications.

Some participants thought that the increase in volume of the locator tone, in response to ambient sound, was a new kind of WALK indication.

In addition, most participants were unfamiliar with the need to use pushbuttons. Most pedestrians who were blind who participated in the research stated that they did not use pushbuttons, unless they knew the pushbuttons were present and knew where they were located. They were unclear on the purpose or function of the pedestrian pushbuttons. Pushbutton locator tones should provide more information, but all pedestrians seem to need more education about pushbuttons and their use and function.

*MUTCD* 4E.08, in 2000, provided more specific location guidance for APS pushbuttons, but it is important that pedestrians who are blind understand the placement of APS. In addition, it was noted that many blind pedestrians were unfamiliar with arrows and were unable to immediately determine which direction the tactile arrow was pointing. Actual hands-on explanation of the APS and pushbuttons can be helpful.

# Providing information to the public

## RADIO, TV AND NEWSPAPER PUBLICITY

It is common for information to be distributed through radio and TV publicity. This information may reach many people, including those who are blind or who have low vision. Newspaper articles, however, may not reach individuals who are blind or visually impaired, particularly those in the growing elderly blind population.

## RADIO READING SERVICES

Radio reading services function in many cities and provide free spots and informational programs aimed at individuals who are blind or who have low vision. Radio Reading Services broadcast the reading of newspapers and books and magazines to the blind, physically impaired and those who have difficulty reading small print. Due to copyright law, Reading Service radio broadcasts are restricted to a closed channel unavailable to the general public. Listeners usually hear the service only by ordering a special 'sub-channel' radio, through special cable service, or through a subscription webstream service.

The radio reading service serving a specific area can usually be located through an internet or phone book search.

## REHABILITATION CENTERS

Rehabilitation centers providing services to individuals who are blind or who have low vision are located in many cities. These centers may have telephone or email based bulletin boards providing news of interest to individuals who are blind. Usually posting information or notices is free. Centers may also provide meeting space or facilitate regular support group meetings.

## CONSUMER GROUPS

There are two main consumer groups of individuals who are blind and who have low vision, American Council of the Blind and National Federation of the Blind. Each organization has affiliate groups and local chapters that usually meet monthly. Speaking to a group meeting is an excellent way to reach a number of individuals who are blind or who have low vision. Information about local chapters and contact information for each chapter is available from the national office and is usually listed on the national organization web pages: [www.acb.org](http://www.acb.org) and [www.nfb.org](http://www.nfb.org).



## NEIGHBORHOOD MEETINGS, BUSINESS ASSOCIATION MEETINGS, SOCIAL SERVICE CLUBS, ETC.

Offering to provide information and speakers to various community organizations ranging from PTA meetings to business association meetings can be another avenue to provide education to individuals in the community where APS are being installed. You will often find individuals who are blind or who have low vision within these groups as well.

## One page flyer about APS installation

Public agencies may find it useful to distribute flyers to inform the public about APS. The following sections list important things to include on the flyer and suggested text for each topic. Notes in italics are for the flyer designer and should not be included on the flyer.

New Accessible Pedestrian Signals (APS) are being installed at *[list intersections]*

*Insert example photo of an APS of the type being installed.*

These APS signals provide audible and vibrotactile WALK indications to help people who have trouble seeing the pedestrian signal. The sounds come from the pushbutton and automatically adjust to ambient sound so they will be louder when the traffic is loud and quieter when traffic is quiet. Audible and vibrotactile WALK indication tell a visually impaired pedestrian that the WALK signal is on, but it is still important that they check traffic to be sure that cars are not running the red light or turning across the crosswalk.

Each APS has the following features:

- Pushbutton locator tone — tone that constantly repeats once per second from each pushbutton. Helps people who are blind or who have low vision find the pushbutton.
- Audible and vibrotactile WALK indications – sound and vibration during the WALK signal

*Insert applicable WALK indication description:*

- o Rapid tick WALK indication — rapidly repeating tick from the pushbutton location to indicate that the WALK signal is on.
- o Speech WALK message — name of the street to be crossed, then “walk sign is on to cross and the street name again. For example, “Haywood, Walk sign is on to cross Haywood.”
- A tactile arrow on the pushbutton, or above the pushbutton, points in the direction of travel on the crosswalk. The arrow vibrates during the WALK signal.

- Actuation indicator—a tone, a click, or a spoken “wait” when the pushbutton is pushed to indicate that the button has been pushed
- Braille street name—street name that the pushbutton controls is on the plate above the pushbutton in braille

*If optional features are installed, add the applicable text below*

- Optional features when you hold the pushbutton in for more than a second
  - o Pushbutton information message—name the street that the pushbutton controls and the other streets at the intersection. Example: “Wait to cross Vermont at Haywood.”
  - o Audible beaconing—Volume of locator tone is boosted during the flashing DONT WALK interval to allow a person who is blind to home in on the opposite corner of the street

*Provide contact information for questions or concerns*

## Specific techniques to be used by pedestrians who are blind at intersections equipped with APS (for Orientation and Mobility specialists)

The following section is adapted from *Crossroads: Modern Interactive Intersections and Accessible Pedestrian Signals* (Barlow & Franck, 2005).

It is particularly important to recognize that the APS information is supplemental to traffic and environmental cues, and only provides information about the status of the signal. The APS WALK indication indicates that the WALK signal is on, not that it is safe to cross. Cars can still be turning across the crosswalk or running a red light. The APS WALK sound can be compared to the “**on your mark**” instruction at the beginning of a race. Though it means that the signal has changed, it is still important to “**get set**” (assess the traffic), then “go” (begin to cross).

### SUGGESTED TECHNIQUES IN USING APS

The only place in the O&M literature where specific techniques are suggested for crossing at intersections using APS is a section in a curriculum on APS, developed for Easter Seals Project ACTION (2003). Based on the experience of the authors and the Project ACTION curriculum, the following techniques are suggested:

- Approach intersection and stop at curb or curb ramp/street edge, maintaining initial alignment; check alignment for crossing by listening to traffic. Even if a pushbutton locator tone is noticed during approach, continue to the curb or edge of street first.
- Determine starting location for crossing, and identify tactile cues to use to realign after pressing the pushbutton, because after pushing the button, there may be no time to listen to parallel traffic and realign before the next WALK signal.

- Listen and evaluate the intersection. Determine traffic patterns and intersection geometry and listen for a pushbutton locator tone, or a tone or speech WALK indication. (important that students/clients understand and can recognize the difference between a pushbutton locator tone and typical WALK indications)
- Search for a pushbutton using a systematic pattern. Even where there is a pushbutton locator tone, a systematic search pattern is needed to maintain orientation. Because dog guides are trained to avoid obstacles they may be reluctant to approach poles supporting pedestrian pushbuttons. It may be more efficient for the handler to use a cane to search initially before teaching the dog to locate the pole.
- Once the APS is located, explore the device and its functioning, including locating the tactile arrow to confirm that the arrow is pointing in the direction of the street being crossed.
- Hold the pushbutton down for more than three seconds, and see if more information is provided.
- Listen to APS and traffic for full cycle to make sure that tones or speech correspond with traffic information.
- Press button and return to predetermined spot at the curb, realign and prepare to cross.
- When WALK indication is heard, confirm that traffic on perpendicular street is stopping or stopped, and listen for initial parallel traffic movements when available. Traffic may still be legally clearing the crosswalk when the WALK begins, so careful listening is important.
- Cross the street using typical alignment techniques (traffic, straight line travel, etc) while continuing to listen for turning cars. In many cases, cars can turn right and left across the crosswalk during the pedestrian phase. Although drivers are supposed to yield to pedestrians, they often do not.
- Be aware that a locator tone on the destination curb may provide additional wayfinding information.
- Continue to be vigilant of traffic even though the WALK indication is on.

## Requesting an APS

The following was copied from the web site of the Environmental Access committee of the Orientation and Mobility Division of the Association for Education and Rehabilitation of the Blind and Visually Impaired. A sample letter is Included.

### **RECOMMENDED PROCESS FOR REQUESTING AN ACCESSIBLE PEDESTRIAN SIGNAL**

- Educate yourself about types of APS available and the applicable regulations.
- Find out who controls the intersection where you're making the request. Sometimes it's a city department of traffic engineering, sometimes it's the county, and sometimes, if it's a state or federal highway, it's the state

Department of Transportation. You can just call the number listed in the phone book for traffic engineering or public works and ask who you need to contact about the traffic signals at that intersection. Get a name, address and phone number. If you get to talk to someone on that phone call, ask what their policy is on APS.

- The request for an APS is strongest if it comes from a consumer who is blind or visually impaired. So, the consumer should make the actual request for modification in a letter to the individual in the traffic engineering department that manages that intersection. (A sample letter is below).
- Include wording in the first letter about the need for “access to information” about the status of the pedestrian signal. If you have to, you can refer back to the ADA and requirements to make the right of way accessible if they refuse or delay installation.
- With the consumer’s permission, follow their letter with a letter of support on your professional letterhead, restating the reasons for the need for the APS at that intersection.
- Follow up with a phone call about a week later to the person who is responsible for that intersection. Remember that most traffic engineers will never have heard of an Orientation and Mobility Specialist (and O&M in traffic engineering terminology is Operations and Maintenance, so don’t shorten your title) and may not have thought about a blind person crossing an intersection independently. Remind them of the letter of request and see how they respond. If they have no idea about APS and where to get them, share that you have a list of manufacturers and would like to meet with them to discuss solutions.
- If you can get the engineer to meet you and the consumer on the street corner, and discuss it there, do it. Be sure to include the consumer at that time. Demonstrate the problems and talk about what the APS would do to help.
- If you have not talked to the engineer within two weeks after they should have gotten the letter, you or the consumer should send a followup letter asking them to contact you.
- If you need to send a third letter, it needs to be copied to the department head, the city ADA coordinator, and a local elected official.
- If they refuse to meet with you or refuse to put in the APS, ask them to send a letter to that effect to the client with a copy to you. Say it nicely, but they’ll know why you’re asking and don’t settle for a non-response. Documentation can be useful if you have to file an ADA complaint. You and the client should document any phone conversations (date, who, what they said, etc.) Hopefully, you won’t need that information later, but just in case, keep track.

## **SAMPLE LETTER REQUESTING AN APS:**

[Date]

[Address to traffic engineer in charge of the intersection]

This letter is to request the installation of an Accessible Pedestrian Signal (APS) at the intersection [insert street names]. As a pedestrian who is blind, I am unable to

use the visual pedestrian signals currently installed at this location and need access to the information in order to cross the street. As you may be aware, there is a bus stop at this intersection; I must cross the street daily to reach the bus stop. [change that last sentence to fit the specifics of the intersection, particularly if there are some issues that make it particularly hard to cross such as poor traffic sounds, lots of right turning traffic, T-intersection, etc.].

I would like to meet with you or someone from your department at the intersection in question to discuss appropriate modifications. I would also like for [insert O&M instructor name], an orientation and mobility specialist at [insert agency name] to join us. You may contact me at [insert phone number or address] or [insert O&M instructor name] at [insert phone number] to set up an appointment. Thank you for your attention to this matter.

Sincerely,

[signature]

cc: [O&M specialist name, agency affiliation]

# Chapter 9:

## U.S. Case Studies

### CHAPTER SUMMARY

The information in this chapter is based on data obtained in 2003 and 2005 through site visits or communication with each agency featured. It should be understood that this chapter reflects the situations in each of these locations *in the year indicated*, even though many agencies have continued to expand their number of APS installations and have increased their experience with installation practices.

### CHAPTER CONTENTS

Montgomery County, Maryland .....	168
Portland, Oregon .....	171
Newton, Massachusetts .....	175
New Jersey DOT — Washington, New Jersey .....	178
West Virginia Division of Highways — Morgantown, West Virginia .....	181
Dunedin, Florida .....	184
Maryland DOT .....	187
Charlotte, North Carolina .....	191
Atlanta, Georgia .....	194
Halifax, Nova Scotia .....	196
Waukesha, Wisconsin .....	199
Ann Arbor, Michigan .....	201

# Case Study: Montgomery County, Maryland

**DATE: MAY 2003**

## HISTORY AND BACKGROUND

The intersection of Fenton Street and Wayne Avenue is the first of eleven locations in the Silver Spring Central Business District (CBD) to be equipped with APS under a pilot program initiated by the County Executive.

## PROCESS AND PROCEDURE

There is no formal procedure to request APS. A committee was formed, in coordination with the Montgomery County Commission on Persons with Disabilities, to make decisions about type and features of APS to be installed.

Most signalized intersections in the county are on state roads, so final decisions of the State Highway Administration on APS policy will affect installation at those locations.

## FUNDING

Costs for the pilot project are absorbed as part of the traffic engineering department budget. An additional line item for APS installation was requested in budget but was not funded.

## DESCRIPTION OF INTERSECTION

These traffic signals are being rebuilt as part of the redevelopment of the CBD. Fenton Street and Wayne Avenue was the first one to be rebuilt, and hence the first to receive APS. All intersection legs are 4 lanes wide. Fenton Street runs approximately north/south and Wayne Avenue runs east/west. There is a leading left turn phase from westbound Wayne to Southbound Fenton.

## DATE INSTALLED

September 2001

## APS TYPE AND FEATURES

Pushbutton-integrated devices from Polara Engineering.

Intersection is pre-timed, with WALK intervals associated with each crossing being provided each cycle, but the APS are actuated (audible and vibrotactile WALK indications are not provided unless the pushbutton is pushed).

APS features:

- Speech WALK message
- Vibrotactile WALK indication
- Pushbutton locator tone
- Tactile arrow
- Pushbutton information message called by extended button press.
- Automatic volume adjustment in response to ambient sound
- Speech WALK message: ‘WALK sign is on to cross Fenton Street’ (or Wayne Avenue)
- Pushbutton information message, provided after an extended button press (three second depression of pushbutton):
  - o Includes both street names
  - o Clarifies to which crossing the button applies
  - o Example: “Crossing Wayne Ave at Fenton St”

## APS INSTALLATION

Devices are installed on all four corners, using stub poles for all in order to place the pushbuttons and APS at the top of the ramp for each direction, separated by at least 10 feet.

Each pole is approximately five feet tall with a substantial base; locations vary somewhat but are generally:

- Within 5 feet of the crosswalk lines extended
- 6-10 feet from the curb, (except on NW corner where further construction is planned and those poles were located farther from the curb)



**Figure 9-1. Pushbutton-integrated APS located on a stub pole beside the level landing of the curb ramp**

The Polara control unit and the microphone, which monitors sound for the automatic volume adjustment, are typically installed inside 18-inch pedestrian traffic signal heads. At this location with 12-inch pedestrian signal heads, the control units were



**Figure 9-2. Pedestrian with dog guide at an APS located in line with crosswalk.**



installed in an exterior box attached to the top of the pedestrian traffic signal heads. The microphone was attached to the box, which located it much higher than usual; however, that placement seems acceptable.

## **INSTALLATION ISSUES**

There were no real problems with the installation. However, locating the poles and APS properly in relation to the curb ramp and as recommended in the MUTCD is difficult. While it may be less of a problem in new construction, it requires thought and planning, as well as extra poles, conduit, wiring and construction in retrofit situations.

## **MAINTENANCE**

Except for some minor adjustments after installation, there have been no maintenance issues or failures.

## **EVALUATION**

No formal evaluation has been conducted. Committee members visited the installation and were generally pleased with the functioning.

## **CONTACT**

Bruce Mangum, Senior Engineer  
Transportation Systems Management Section  
Division of Public Works and Transportation  
Montgomery County Maryland  
101 Monroe Street, 11th Floor  
Rockville, MD 20850

Phone: 240-777-8778

Fax: 240-777-8750

E-mail: [bruce.mangum@montgomerycountymd.gov](mailto:bruce.mangum@montgomerycountymd.gov)

## Case study: Portland, Oregon

**DATE: JULY 2003**

### HISTORY AND BACKGROUND

The City of Portland has had some form of audible pedestrian signal for over 20 years. In installing these devices, staff worked closely with the requester to identify specific needs.

- In the late 1970's, city staff installed buzzer-like devices at three intersections on request basis. These buzzers were inexpensive devices purchased from a local electronics store. The buzzer was only activated with a normal pedestrian push button call.
- During the late 1980's the City began using an inexpensive Mallory chime as an audible device. It was installed in some fixed timed intersections as well as actuated intersections.
- By 1995 the City had ten signalized intersections with audible devices.
- In 1996 the City decided that a more formal policy was necessary and a process was implemented, which was revised in 1999 by a Citizens Advisory Committee.

During the past five years the City has greatly expanded its program. By mid-2003, the City had 53 signalized intersections with some form of audible signal.

The City of Portland was awarded a Pedestrian Project Award for 2003 from ITE and the Partnership for a Walkable America. The award was for the Elderly and Mobility category for Portland's project to retrofit existing signals with APS.



**Figure 9-3. APS mounted over 12 feet high on the pole broadcast speech messages at this location in Portland. City engineers expressed concerns about intelligibility of the message.**

### PROCESS AND PROCEDURE

A formal policy was established in 1996.

- City staff assembled a stakeholders group, which included representation from the Oregon Council of the Blind, the National Federation of the Blind, the Oregon Commission for the Blind, Independent Living Resources, and other groups representing both the visually impaired community and mobility instructors.
- The policy was developed over a series of three meetings.

Key points of that policy:

- Audible signals are installed only on a request basis.
- The intersection has to have some unique or unusual characteristics that warrant the addition of an audible signal.
- Referral to a mobility specialist is required; this service is provided through an agreement with Oregon Commission for the Blind. In some instances the crossing problems may be related to a lack of user skills that might be better addressed by further training.

In mid-1999 the requests for audible signals outstripped City resources for the program. A citizens advisory committee (CAC) was activated to review and rank the requests.

- The CAC and City staff started with a ranking process similar to that used in the City of Los Angeles.
- Staff applied the criteria to ten intersections on the request list. CAC made some revisions to the scoring criteria (See Appendix D).
- Scoring materials were developed. The electrician responsible for the installations and a mobility instructor from the Oregon Commission for the Blind meet the requester at the candidate intersection to better understand the user's needs and concerns. After agreeing that some sort of audible signal is a viable solution, the City staff person and mobility instructor complete field aspects of the scoring form. Information such as volumes and accidents is gathered by office staff from existing City records and added to the scoring form.
- CAC meets semi-annually to rank the requests.

## FUNDING

From 1996 through 2000, the City used approximately \$150,000 in general transportation funds to install APS. That funding source for APS has been lost. To continue with new installations, the City received over \$200,000 in transit mobility funds from the local transit agency. However, that grant expires in July 2004 and no replacement funding source has been identified yet.

## APS TYPES AND FEATURES

Pedhead-mounted at numerous intersections. Pushbutton-integrated at two intersections.

Pedhead-mounted devices manufactured by Novax and Mallory

Pedhead-mounted APS features

- WALK indication — cuckoo/chirp, beep, or chime
- Extended button press to call accessible features on some devices (no locator tone is used.)

Pushbutton-integrated devices, manufactured by Polara Engineering and Campbell Company, have been installed recently with locator tones and additional features.

The City of Portland has also evaluated the Vibrawalk pushbutton manufactured by Novax Industries.



**Figure 9-4. Vibrawalk pushbutton installed in Portland includes a locator tone. The arrow vibrates during the WALK interval and WALK indication is provided from pushbutton or speaker mounted on the pedhead.**

## SPECIAL FEATURES

Portland staff has worked with manufacturers on developing features:

- After 1996, in deference to requests of members of the National Federation of the Blind, a technology was used that requires the user to hold the button for at least one second to place a call for an audible signal to make the technology ‘refuseable’. Button Activated Timer (BAT), from Novax Industries of British Columbia, requires that the button be depressed for at least one second to call the audible indication.
- Staff worked with Novax and McCain to take the speaker and electronics out of the exterior Novax housing and mount them directly in the pedhead to afford more protection from vandalism and place the speaker closer to the users’ ears.

In 1999, the CAC and City staff expressed a desire to find lower cost options so that more intersections could be treated. City staff received approval from the CAC to install lower cost Mallory devices. Since the Mallory device has neither automatic volume adjustment nor Button Activated Timer, city staff is careful to use the device only in locations that are that are not close to residences.

## DATE INSTALLED

Between 1970’s and present

## INSTALLATION

Installation varies greatly from intersection to intersection. Portland transportation engineering staff reports that the largest problem faced is with existing infrastructure. The aging transportation system makes installing new wires in old, undersized conduits a challenge. Location of existing poles also poses a problem. As intersections evolve throughout their life span, poles for pushbutton locations are often located in areas that are less than desirable for accessible pedestrian installations.

Obstructions, such as utility and sign poles, also are a significant challenge. These obstacles often make placement of pushbutton locations difficult, translating into higher installation costs.

Proximity of poles, in relation to one another, also has to be taken to account. Volume level of the “WALK” cue and locator tone must be loud enough to tell

pedestrians to go, but quiet enough to not give a false “WALK” cue to someone at a conflicting ped lane. This can be difficult at intersections with odd configurations, such as islands with separately actuated ped lanes.

## MAINTENANCE

Maintenance of equipment has been almost a non-issue. There have been few maintenance problems although it should be noted that most of the equipment with electronics mounted in the pedhead or pushbutton is relatively new. These installations are only one to six years old so there is not a long maintenance history on those devices.

## EVALUATION

Portland tested a variety of WALK indications

- Earliest sounds for the WALK were a buzzer and Mallory chime.
- A trial installation used voice messages. The voice message typically said “The WALK light is now on to cross 41st Street”. Although equipped with ambient sound adjustment to increase the output as background noise increased, the voice message was often difficult to hear.
- Tones seem to be better for cutting through background noise in an urban street environment. After the initial test with voice and tones, the City decided to use the cuckoo and chirp sounds.

Community Response/reactions:

- Buzzer—Staff received some calls regarding the annoying sound and usually responded by placing some sort of baffling material around the buzzer.
- Mallory chime—The chime was a more pleasing sound and the City seldom received any noise complaints, even though the chime was installed in some fixed time intersections

## CONTACTS

Bill Kloos, Signal and Street Lighting Manager  
 Portland Department of Transportation  
 1120 SW 5th Avenue / Suite 800  
 Portland, OR 97204-1971  
 Phone: 503-823-5382  
 E-mail: Bill.Kloos@pdxtrans.org

Jason McRobbie, District Electrician  
 Portland Department of Transportation  
 1120 SW 5th Avenue / Suite 800  
 Portland, OR 97204-1971  
 Phone: 503-823-1773  
 E-mail: Jason.McRobbie@pdxtrans.org

## Case study: Newton, Massachusetts

**DATE: JULY 2003**

### **HISTORY AND BACKGROUND**

APS were installed at the major intersection in Newton, Massachusetts in 2001, as part of a major signalization upgrade project, and at the recommendation of the Mayor's Committee for People with Disabilities (Mayor's Committee). This is Newton's first experience with this signal type.

### **PROCESS AND PROCEDURE**

#### *New construction and signal up-grades*

When new signals are installed in Newton, the Mayor's Committee considers whether they should have accessible pedestrian signals. Their recommendation is then referred to the departments of Public Works and Planning. For example, when signalization at an intersection is being upgraded from a flashing beacon to full signalization, input is obtained from the Mayor's Committee.

#### *Handling individual requests*

Individual requests are referred simultaneously to the Mayor's Committee and to the Traffic Council. The Traffic Council is required to respond to requests by making a decision within 12 weeks.

#### *Consultation with local agency for the blind*

The City Traffic Engineer also consults with an orientation and mobility specialist at the Carroll Center for the Blind regarding the need for APS and for suggestions regarding the most appropriate type of APS for a particular intersection.

### **FUNDING**

APS in Newton were funded jointly by Public Works and Planning, with a portion of the cost being covered through the Community Development Block Grant program.

The City of Newton currently has \$10,000/yr earmarked for APS.

## DESCRIPTION OF INTERSECTION

The APS were installed at a complex intersection with high pedestrian and vehicular traffic counts. At this intersection, three crosswalks share the same exclusive pedestrian phase timing:

- One is a mid-block arterial crossing;
- One is a minor street intersecting the arterial in a “T”, near the mid-block crossing;
- The other is across a third street that enters the arterial diagonally, close to the “T” intersection of the minor street.

Because of abundant turning traffic during all vehicular phases, there is no safe crossing time for pedestrians, except during the exclusive pedestrian phase.

## APS TYPE AND FEATURES

Pushbutton-integrated APS manufactured by Bob Panich Consultancy.

APS Features:

- WALK indication – audible rapidly repeating tones
- Vibrotactile WALK indication
- Pushbutton locator tone
- Alert tone
- Tactile arrow
- Automatic volume adjustment in response to ambient sound.

**Figure 9-5. Panich APS at mid-block crossing, Newton, Mass. APS should have been mounted on side of pole closest to crosswalk, with arrow parallel to crosswalk rather than pointing up.**



## APS INSTALLATION

At another intersection at which APS were installed, a stub pole was installed in order to locate the pushbutton properly for one crosswalk.

## INSTALLATION ISSUES

Installation presented no technical difficulties.

Initially the APS volume was set so loud at one location that the WALK signal was audible from a nearby intersection, possibly leading pedestrians at that intersection to believe they had the WALK interval when they did not. The volume was turned down several months after the APS were installed.

Although the basic requirement in Newton for conduit in public rights-of-way is a 36" trench, actual construction may be less than 36" depending on site conditions. It is important that such an installation be based on direct field knowledge, rather than be designed in the shop.



**Figure 9-6. Panich APS for crossing the stem of a “T” intersection.**

## **MAINTENANCE**

No maintenance, except for volume adjustment, has been necessary since the audio-tactile pushbuttons were installed. Weather does not seem to affect their performance, and there has been no vandalism.



**Figure 9-7. Panich APS on stub pole in Newton, Mass. Arrow oriented parallel to crosswalk.**

## **EVALUATION**

The APS have been well-received by blind users, and there have been no objections from neighbors.

The APS are in a small business area, not close to any residences.

## **CONTACT**

Roy Lamotte  
City Traffic Engineer  
City of Newton, MA  
Phone; 617-796-1020  
E-mail: rlamotte@ci.newton.ma.us



# Case study: New Jersey DOT – Washington, New Jersey

**DATE: JULY 2003**

## HISTORY AND BACKGROUND

The New Jersey Department of Transportation has been sensitive to the needs of the visually impaired. The first vibratory (with raised directional arrow) pushbuttons in New Jersey were installed in 1992 at the Rowan College signalized pedestrian crossing across Route 322. As of August 2000, NJDOT had installed APS devices at four intersections. The devices at the location described and pictured here, Route 31 and Route 57, were installed in the fall of 2000. NJDOT has recently installed APS devices at other intersections and expects to install more devices.

## STUDY BY NJ DOT

A project for the installation and evaluation of four types of APS devices at intersections in Morristown, NJ was funded by NJ Highway Traffic Safety and was conducted by Edwards and Kelcey in cooperation with The Seeing Eye. More information is provided in the Appendix on Research.

## PROCESS AND PROCEDURE

There is no formal process for deciding to install an APS.

These APS devices were installed at the request of a blind person in conjunction with reconstruction of the intersection. An orientation and mobility specialist provided information used in making a decision about type of APS selected.

## FUNDING

The APS signals are funded under the general state fund with no special funding sources.

The cost of the devices was \$400.00 per device to NJDOT, plus installation by NJDOT forces. NJDOT went out to bid for the devices.

## DATE INSTALLED

Fall 2000

## DESCRIPTION OF INTERSECTION

Route 31 and Route 57, major intersection of four-lane undivided road and two and three lane road with parking lane at the edge of small downtown CBD. There are four traffic islands with signalized crossings to the islands. Pushbuttons were installed at all crossings for a total of twelve devices at the intersection.

## APS TYPE AND FEATURES

Pushbutton-integrated APS manufactured by Polara Engineering

APS features:

- Vibrotactile WALK indication
- Pushbutton locator tone
- Tactile arrow
- Braille street name
- Actuation indicator — tone

## APS INSTALLATION

APS were installed at all crosswalks to provide the signal information at all possible crossings used by the blind person. It is a state standard to put two push buttons on the same pole, with no stand-alone pole for the APS. This meant that some devices were located a distance from the beginning of the crosswalk. Because the only WALK indication was vibrotactile, the WALK interval was lengthened to provide time for a pedestrian who is visually impaired to reach the departure curb after the WALK began.



**Figure 9-8. Installation of two pushbuttons on a single pole (only a single push-button is visible in the photo). While the push-button is in line with the crosswalk, the pedestrian must travel over 10 feet before reaching the street and the beginning of the crosswalk.**

These devices were installed as a retrofit before various recommendations and guidelines were issued. Currently, recommendations of the Public Rights-of-Way Access Advisory Committee (PROWAAC) and Draft Public Rights-of-Way Accessibility Guidelines (Draft PROWAG) state that devices should provide audible and vibrotactile information about the WALK interval. These APS are vibrotactile only, so do not conform to these recommendations. MUTCD and Draft PROWAG recommendations also encourage installation of devices on two poles separated by at least 3 meters. If separation is not possible, Draft PROWAG recommends speech messages for the WALK interval; vibrotactile indication was used here.

## INSTALLATION ISSUES

No major installation issues

## MAINTENANCE

There have been no reported maintenance problems except the vibrating arrows on a couple of devices have gotten stuck and stopped vibrating.

There has been no vandalism.

**Figure 9-9. APS mounted on signal pole for crossing signalized right turn lane. Pedestrian who is blind is waiting with her hand on the pushbutton for the vibrotactile WALK indication. After the WALK indication begins, she must turn, and cross the sidewalk before beginning to cross the street.**



## EVALUATION

There are no reports of complaints or comments received from the general public or individuals in the community. In some other installations, there have been complaints due to the locator tone increasing due to the traffic noise and bothering the people that live close to the intersection.

There were complaints at first from the blind woman using the device regarding placement of the devices and ability to line up and cross while keeping her hand on the vibrating arrow. She was trained to use the APS by an orientation and mobility specialist and was able to use them adequately.

Placement is problematic for a device that is vibrotactile only. In order to keep her hand on the device, the user must stand back from the crosswalk, and turn toward it after the WALK indication begins.

There has been no research or evaluation regarding the APS either before or after the installations.

## CONTACTS

Tim Szwedo  
Traffic Safety and Engineering  
NJ Dept. of Transportation  
P.O. Box 613  
Trenton, NJ 08625  
Phone: (609) 530-2601  
E-mail: Timothy.Szwedo@dot.state.nj.us

Paul Vetter  
Director, Traffic Engineering  
Edwards and Kelcey  
E-mail: pvetter@ekmail.com

# Case study: West Virginia Division of Highways — Morgantown, West Virginia

**DATE: JULY 2003**

## HISTORY AND BACKGROUND

APS were installed in 2002, at the request of blind citizens. These are the first APS that have been installed in the state.

## PROCESS AND PROCEDURE

Morgantown does not have a process or procedure for determining which intersections will be equipped with APS. Typically, all traffic signal installations in West Virginia are installed by contract under the purview of the West Virginia Division of Highways.

## FUNDING

This demonstration project was fully funded by the West Virginia Division of Highways.

## DESCRIPTION OF INTERSECTIONS

APS were installed at two intersections in the downtown area of Morgantown that have pedestrian actuation, and exclusive pedestrian phasing with right turns on red permitted.

## APS TYPE AND FEATURES

Pushbutton-integrated APS manufactured by Prisma Teknik (model TS-903).

### APS FEATURES:

- Tone WALK indication - fast tick, a rapid repetition of the pushbutton locator tone for crossing in both directions
- Pushbutton locator tone
- Tactile arrow
- Actuation indicator
- Tactile map of crossing
- Automatic volume adjustment in response to ambient sound

Signals are being modified to include pushbutton information messages modeled after “Wait to cross Willey St. at High St. Wait for red light for all vehicles. Right turn on red permitted.”

## APS INSTALLATION

Two pushbuttons have been mounted on some corners so the standard single arrow can be correctly oriented in the same direction as each crosswalk. This was necessary where the two crosswalks at a corner were not at right angles to each other.

Since these locations used exclusive pedestrian phases, a right-angle, double ended arrow was installed so that a single pushbutton could be located on one corner or quadrant, controlling the WALK signal for two crossing directions. The right angle arrow will be installed where both crossings are 90 degrees from a particular quadrant.

**Figure 9-10. Mounting of two Prisma pushbutton units on a single pole. See arrows on insert detail for the orientation of the tactile arrow on the top of each unit. Both devices make the same sound during the WALK indication, which is acceptable in this installation since there is exclusive pedestrian phasing.**



## INSTALLATION ISSUES

Wiring of the APS was little different than typical (non-APS) pushbuttons.

APS are mounted to signal uprights using two quarter-inch stainless steel screws. In the future, stainless steel bands may be placed at the top and bottom sections of APS in high-vandalism areas.

Diligence is needed in the initial design of a complete intersection, so as to correctly locate APS according to the MUTCD.

## MAINTENANCE

No weather-related maintenance issues have been reported.

Cabinets and signals are well guarded against transient voltage surges, including high-speed surges that are accompanied by lighting.

To date, APS have been installed at six intersections in West Virginia. At one intersection in downtown Charleston, in a high vandalism area, three APS have been knocked off the signal upright.

## EVALUATION

APS have performed as expected according to manufacturer's literature.

Negative comments have been received from nearby businesses about the noise level of the locator tone. The entrance to one business is less than 10 feet from the pole on which two APS are mounted.

Blind users have objected to the location of some APS units (in some cases at a distance of about 20 feet from the crosswalk).

Positive comments have been received about proactive installation of APS.

## CONTACTS

Barry Warhoftig  
Traffic Engineering Division  
West Virginia Div. of Highways  
Building 5, Room 550  
1900 Kanawha Blvd, E.  
Charleston, WV 25305  
Phone: 304 558-3722  
E-mail: BWarhoftig@ dot.state.wv.us

Bruce Kenney  
Traffic Engineering Division  
West Virginia Div. of Highways  
Building 5, Room 550  
1900 Kanawha Blvd, E.  
Charleston, WV 25305  
Phone: 304 558-3063  
E-mail: Bkenney@dot.state.wv.us

## **Case study: Dunedin, Florida**

**DATE: JULY 2003**

### **HISTORY AND BACKGROUND**

There are two intersections in downtown and one at Patricia Avenue and Beltrees in Dunedin where APS have been installed at the request of citizens who are blind.

The City of Dunedin was awarded the Inspired Leadership Award for 2003 from the Florida Alliance for Assistive Services and Technology (FAAST) for the APS installations.

### **PROCESS AND PROCEDURE**

Requests for APS are received by the City of Dunedin ADA Coordinator and reviewed and recommended by the City Manager appointed ADA Committee.

APS were requested by one person who is blind and who has limited hearing in one ear as well. She consulted with an orientation and mobility specialist and requested pushbutton-integrated devices and worked with the engineer on installation details.

### **FUNDING**

The intersection modifications were part of a redevelopment project.

### **DESCRIPTION OF INTERSECTIONS**

One of the intersections downtown, Douglas & Main is a fairly small square intersection of two-lane streets with a pushbutton actuated exclusive pedestrian phase.

The other intersection downtown at Broadway & Main is a more complex intersection where a very busy state road intersects with the city's Main Street.

The third intersection, at Patricia and Beltrees, is a T intersection of a minor street with very busy street with a right turn lane.

### **APS TYPE AND FEATURES**

Pushbutton-integrated devices from Polara Engineering

APS features

- Speech WALK message:
  - At Douglas and Main (with exclusive pedestrian phasing): “WALK sign is on”
  - At Broadway & Main: “WALK sign is on to cross Main” or “WALK sign is on to cross Broadway”
- Vibrotactile WALK indication
- Pushbutton locator tone
- Actuation indicator – tone
- Tactile arrow
- Automatic Volume Adjustment in response to ambient sound
- Extended button press – increased the volume of the WALK indication and locator tone

## APS INSTALLATION

Two APS were mounted on each pole.

At one crossing APS were about 15 feet back from the crosswalk location, and approximately 5 feet toward the intersection from the extension of the crosswalk lines. Volume of locator tone and WALK message was quite loud

At the Patricia and Beltrees location, APS were installed on only one crosswalk, to cross the through street, as needed and requested by the person who lived near the intersection.



**Figure 9-11. Two pushbuttons are located on fluted pole at this location with exclusive pedestrian phasing. Tactile arrow of each device points in the direction of travel on the crosswalk.**

## INSTALLATION ISSUES

Installers stated that they had difficulties with figuring out the new devices but seemed to work fine after they figured them out.

Fluted poles were used in the redesign which made it difficult to align the tactile arrow.

## MAINTENANCE

No maintenance issues have been reported except for need to adjust volume levels.

## EVALUATION

Installation caused complaints from patrons of a restaurant/bar on one corner with outdoor seating. Locator tone was loud enough to hear from over 30 feet away.



The woman who requested the installation was initially unhappy with some parts of the installation. Original plans included a stub pole close to the crosswalk but that was not installed at first. Even with the signal adjusted to the maximum volume, she was unable to hear the WALK indication when she was standing at the crosswalk location. A stub pole was later installed which allows a reduction in volume of the device and diminishes problems for neighbors as well.

## **CONTACTS**

Barbara Fidler, ADA Coordinator  
City of Dunedin  
542 Main Street  
Dunedin, FL 34698  
Phone: 727-298-3010 v/tdd  
Fax: 727-298-3012  
E-mail: [bfidler@dunedinfl.net](mailto:bfidler@dunedinfl.net)

Michael Gust, P.E.  
Division Dir. of Traffic Control  
City of Dunedin, Traffic Division  
822 Lake Haven Road  
Dunedin, FL 34698  
Phone: 727-298-3224  
Fax: 727-298-3219  
E-mail: [mgust@dunedinfl.net](mailto:mgust@dunedinfl.net)

## Case study: Maryland DOT

**DATE: JULY 2003**

### HISTORY AND BACKGROUND

During the 1980's and 90's, Maryland installed some APS of the cuckoo/chirp type at locations throughout the state, including Montgomery County, Frostburg, Lutherville, and Towson.

Maryland DOT, in response to concerns about mobility for persons who are visually impaired through unique intersections, such as roundabouts, and the addition of the APS section to the MUTCD, convened a committee in November 2000 to develop criteria for installation and prioritization plans for installation of APS.

The committee consisted of representatives of the visually impaired community, traffic engineers, orientation and mobility specialists, local ADA coordinators and DOT staff

The goals of the committee included:

- Identify factors affecting mobility of the visually impaired through intersections
- Identify and reconcile differences of approach to mobility issues within the visually impaired community
- Develop a rating and prioritizing process for APS

### PROCESS AND PROCEDURE

The committee developed a prioritization checklist. This checklist has been used on approximately 40 intersections to date, with scores ranging from 14 to 46 out of a possible total of 60. While each crossing receives a rating, the highest rating for any crossing is used for the intersection.

At this time, Maryland is considering any intersection with a rating greater than 36 to be a high priority. Eleven intersections are rated at this level and have either had APS installed or are under design for installation.

### FUNDING

Maryland considers an APS to be a traffic control device and as such funding is from traffic control, highway construction and Federal funds.

## TYPE OF APS USED

Pushbutton-integrated APS manufactured by Polara Engineering

APS features:

- Speech WALK message, with option of cuckoo/chirp if desired for specific location
- Vibrotactile WALK indication
- Pushbutton locator tone
- Tactile arrow
- Actuation indicator
- Pushbutton information message in response to extended button press
- Automatic volume adjustment in response to ambient noise levels

Maryland is also testing and evaluating equipment from other manufacturers.

## DESCRIPTION OF INTERSECTION

Installation Example 1, Loch Raven and Taylor, is a large intersection with right turn islands, heavy traffic volumes and left turn lanes on all approaches.

## APS INSTALLATION

Existing poles were used at this location with channelizing islands and uncontrolled right turn lanes in three of the four quadrants.

**Figure 9-12. Two APS are mounted on the existing pole on this island.**



**Figure 9-13. APS as seen from right-turn lane crossing.**



## EXAMPLE 1 — LOCH RAVEN & TAYLOR

WALK indication is a speech message. The volume levels of the APS were carefully adjusted to prevent the WALK indication from being audible to pedestrians before they crossed the right turn lane. The speaker is blocked on the side away from the intersection. However, wind, humidity and large trucks can affect the sound levels and the signals may be audible from the sidewalk under certain conditions. In this case, the person who requested the signals is familiar with the geometry.

## DESCRIPTION OF INTERSECTION

Installation Example 2, Loch Raven and Glen Keith, is an intersection with low side street volumes. The APS is to cross the major street (Loch Raven) only. There are no pedestrian indications to cross the minor (Glen Keith) so APS were not installed for those crossings. The major street is quite wide, with a median island and a stop sign controlled service road along the west side of Loch Raven. Again, the volumes needed to be carefully adjusted. Vehicular signal pole was used for one APS but others were located close to the crosswalk on pedestrian signal poles.

### EXAMPLE 2 — LOCH RAVEN & TAYLOR



Figure 9-14 APS installed on pedestrian signal pole



Figure 9-15. View across Loch Raven toward two median islands and stop sign controlled service road.

## INSTALLATION ISSUES

Mr. Paulis of the Office of Traffic and Safety states that the location of pushbuttons and other APS equipment is of high importance in providing a properly operating system for pedestrians who are visually impaired. In many cases, it is not desirable to only use existing poles for the installation of APS. The installation of additional pedestal poles is often necessary to insure the proper location of APS relative to crosswalks and curb cuts.



Figure 9-16. APS installed on signal pole beside crosswalk waiting location.

Adjustment of initial volume levels for use has been an issue. Obtaining the proper balance between the needs of the persons who are visually impaired and surrounding development while not presenting misleading information to pedestrians has proved to be difficult. Complicating the process are uncontrollable factors, that is, traffic noise and weather conditions such as wind and rain.

## **MAINTENANCE**

There have been some failures of the control boards, but these may not be excessive when considering that the equipment is a new and relatively recent design and the growing pains associated with new technology.

## **EVALUATION**

No formal evaluation has been conducted of installations. Most individuals who have requested the installations seem to be pleased.

## **CONTACTS**

Edward T. Paulis, Jr., Office of Traffic and Safety  
Maryland State Highway Administration  
7491 Connelley Drive  
Hanover, MD 21076  
Phone: 410-787-4092  
E-mail: [epaulis@sha.state.md.us](mailto:epaulis@sha.state.md.us)

## Case Study: Charlotte, North Carolina

**DATE: JULY 2003**

### HISTORY AND BACKGROUND

Charlotte began installing pushbutton-integrated APS in 1999 after discussion with the Charlotte/Mecklenburg Advocacy Council of People with Disabilities Committee. Approximately twelve intersections with forty-two pushbutton-integrated APS devices are now installed. Before that, pedhead-mounted APS had been installed upon request; current staff are not sure when those devices



**Figure 9-17. An early Polara installation in Charlotte**

were installed or how the decision was made to install them. They state that they are replacing current “chirpers” with pushbutton-integrated devices.

Orientation and Mobility specialists helped evaluate APS products in advance and made recommendations to engineers.

### PROCESS AND PROCEDURE

APS are requested by citizens and installed after review by staff of Metrolina Association for the Blind. In general, devices are installed in the order of request, depending on how much construction is involved.

The Charlotte/Mecklenburg Advocacy Council for People with Disabilities Committee and the Metrolina Association for the Blind serve as liaisons between the person who is visually impaired and the city.

### FUNDING

City council approved \$95,000 in a restricted fund that is carried over year to year for purchase of equipment. The installation cost is covered in the normal budget. The public and individuals who are blind were involved in making the request for funding and getting it approved.

### APS TYPE AND FEATURES

Pedhead-mounted devices before 1999

Pushbutton-integrated devices from Polara Engineering since July 1999

APS features (pushbutton-integrated device installations):

- Speech WALK indication
- Vibrotactile WALK indication
- Pushbutton locator tone
- Tactile arrow
- Actuation indicator
- Pushbutton information message in response to an extended button press
- Automatic volume adjustment in response to ambient sound

**Figure 9-18. Recent Polara Navigator installation.**



## INSTALLATION ISSUES

The first generation Polara device did not accommodate pre-timed or “ped recall” locations. It was designed to look for a logic common signal from the controller. Using instructions provided by Polara, city technicians in the signal shop modified the printed circuit board, including adding a resistor and two jumpers. This being done, the devices were usable in these situations.

A simple jumper setting has addressed this problem with the newer Polara product. The first generation Polara (installed at four locations) was also more labor intensive to install. Installers drilled holes in the top of the device to accept conduit on wood pole locations.

The newer version Polara Navigator has addressed all installation concerns.

When it is necessary to install new poles to locate the device more appropriately, it takes longer and more funds, because traffic engineering has to coordinate with various departments to fix curb ramps and work around other utilities. Installation can be time-consuming when a new pole is needed.

## MAINTENANCE

No problems reported

In early installation where two devices were on the same metal pole, it was possible to feel the vibration during WALK on both devices at the same time (separate WALK phases). This was solved by insulating between the device and pole. A speaker problem was resolved by improving the installation method through efforts between the City Electronics Tech and the manufacturer.

## EVALUATION

The Public Service Department has no complaints regarding the devices. However, staff of Metrolina Association for the Blind received some complaints about the noise level of the locator tones, especially in residential areas. The volume can easily be adjusted.

The City of Charlotte placed in the top ten U.S. cities in the Accessible America contest a year ago and in the top seven this past year. Metrolina Association for the Blind has provided very favorable input and review of this project. Communication between all agencies involved has made this project a success.

## CONTACTS

Tamara (Tammy) Drozd, Signal System Specialist  
City of Charlotte NC  
600 East Fourth Street, Charlotte, NC, 28202-2858

Phone: 704-336-4385

Fax: 704-336-4400

E-mail: [tdrozd@ci.charlotte.nc.us](mailto:tdrozd@ci.charlotte.nc.us)



## Case Study: Atlanta, Georgia

**DATE: MAY 2003**

### HISTORY AND BACKGROUND

Atlanta has installed APS upon specific request since 1992. Until April 2003, all devices installed had been pedhead-mounted devices. The city is evaluating pushbutton-integrated devices as part of a research project. There have been requests by citizens who are blind for devices with pushbutton locator tones at pushbutton actuated locations, however the city has not installed them generally to date.

### PROCESS AND PROCEDURE

Individuals who are blind or visually impaired make a request to the traffic engineering department. The engineer evaluates the intersection and current timing and signalization. He may meet the blind person and an orientation and mobility specialist (usually from the Center for the Visually Impaired) at the intersection to discuss the problems.

Requests are prioritized by date of request and volume of traffic.

If the request is for an APS at a signalized intersection and devices are in stock, they can usually be installed in less than a month.

### FUNDING

City traffic engineering funds, however, some private developers have paid for street improvements as part of a development project.

**Figure 9-19. Pedhead-mounted speaker mounted on the pole as typically installed in Atlanta.**



### APS TYPE AND FEATURES

Pedhead-mounted devices from IDC/US Traffic are installed at approximately 15 intersections.

APS features:

- WALK indication—Cuckoo/chirp
- No pushbutton locator tone
- No automatic volume adjustment

Atlanta has recently installed pushbutton-integrated APS from Polara Engineering and a receiver-based system from Relume as part of a research project.

## DATE INSTALLED

1992 to present

## INSTALLATION ISSUES

Pedhead-mounted devices are simple to wire and install on the pole or on the pedhead.

Signal shop found the pushbutton-integrated device to be very difficult to install, requiring additional wiring and careful adjustment. After installation, the control unit of one APS was malfunctioning and the device was not sounding; manufacturer replaced the unit.

## MAINTENANCE

Many pedhead-mounted units have been installed for five to ten years or more without problems. Recently, two units failed two consecutive times until engineers found that water was getting into the devices, probably through the speaker holes. They recommend double checking the seals and mounting the speakers under the pedheads to protect them from the impact of heavy rain.

In general, Atlanta's department considers pedhead-mounted devices very reliable and serviceable. Vandalism has not been a problem.

## EVALUATION

The traffic engineering department has received some complaints about noise levels of pedhead-mounted speakers (ones currently installed do not have automatic volume adjustment), but complaints have usually stopped a couple weeks after installation. At times, they have adjusted the volume after installation.

The city looked at pushbutton-integrated devices with locator tones to address concerns of persons who are blind about finding the pushbuttons. However, the signal maintenance department prefers to install the pedhead-mounted devices, as long as there are no complaints.

## CONTACTS

Santana Herrera, Traffic Systems Engineer  
City of Atlanta Traffic and Transportation  
68 Mitchell Street, SW  
4900 City Hall South, Atlanta, GA 30303  
Phone: 404-330-6501  
E-mail: sherrera@ci.atlanta.ga.us

# Case Study: Halifax, Nova Scotia

**DATE: APRIL 2005**

## HISTORY AND BACKGROUND

Halifax has been using pedhead-mounted APS since 1998. Pushbutton-integrated units were introduced in 2003 and are now in operation at five intersections. The APS units were installed in response to requests from the Canadian National Institute for the Blind (CNIB). All installations were retrofits to existing signals and were performed by a contractor.

## PROCESS AND PROCEDURE

Requests for APS installations come from the CNIB which typically provides the city with a list of intersections where they would like APS installed. The city reviews the list and selects intersections for APS installations based on design of the intersection and available funding. If the intersection is suitable for pushbutton-integrated units, they install Novax Vibrawalks in addition to the overhead speaker. Factors that affect the decision about pushbuttons include suitability of pole location and availability of wiring.

## FUNDING

APS in Halifax were funded by the capital budget in a specified fund for pedestrian safety issues. There was also a federal 50-50 funding match in 2004 for APS installations.

## APS TYPE AND FEATURES

Pedhead-mounted and pushbutton-integrated devices from Novax Industries (DS2000 for overhead speaker units and Novax Vibrawalk for pushbutton)

APS features (at installations where pushbutton-integrated devices are installed):

- Vibrotactile WALK indication
- Audible WALK indication, only in response to an extended button press
- Pushbutton locator tone
- Tactile arrow
- Actuation indicator
- Automatic volume adjustment, in response to ambient sound

## INSTALLATION ISSUES

The APS speaker is mounted on top of the pedestrian head and faces across the street. A typical configuration for a crossing in Halifax involves two APS speakers, one at each end of the crossing. The volume is adjusted so the sound only reaches  $\frac{3}{4}$  the way across the street, intended to enable the user to detect the second APS when part way across the street to guide them in the proper direction. Setups with only one APS per crossing generated numerous noise complaints as the volume has to be higher to be heard across the street.

Most APS are installed on aluminum poles but some locations have wooden poles, as shown in Figure 9-20. The overhead APS on wooden poles are clamped to the signal arm or pedestrian head. Novax pushbuttons typically are wired through the back of the device. To wire the pushbuttons,  $\frac{1}{2}$ -inch PVC conduit is strapped to the wooden pole and an LB or liquid tight flex pipe runs a hole drilled into the bottom of the pushbutton.



**Figure 9-20. APS pushbutton mounted on wooden pole, showing conduit installed into the bottom of the pushbutton device**



**Figure 9-21. APS speaker mounted on signal head support arm.**

The overhead speakers are typically mounted to the pedestrian signal head. When the APS speakers were mounted into plastic (polycarbonate) signal heads, strong winds would push on the speaker and crack off the thin plastic of the signal head into which the speaker was mounted. Where there were plastic pedestrian signal heads, the speaker was mounted on the pole or some other metal or wood surface, as shown in Figure 9-21. Pedestrian signal heads made of aluminum did not have this issue. In areas with less of a problem with strong winds, this may not be a concern.

Availability of wiring at the pole is an important issue. If sufficient wiring is installed with the signal, installing an APS later is much easier. Pulling wire later can become prohibitively expensive.

## MAINTENANCE

The city handles the maintenance of the devices. Being near the ocean, moisture and salt in the air is a problem, as is salt on the roads for de-icing. The overhead speakers generally start having problems at the 5-year mark, due to the salt and moisture.

They usually last from 5 to 10 years. . The Vibrawalk pushbutton devices have not shown any problems during the two years they have been in service.

## **COLD WEATHER ISSUES**

Snow is a constant problem in the Halifax climate. Snow banks can prevent access to the pushbuttons when not cleared properly. For intersections where pushbuttons are used, pole placement becomes an important issue so all pedestrians can reach the pushbutton. If pushbuttons are located to the immediate left or right of the crosswalk, there's a better chance of them being reached by pedestrians and having the snow cleared properly. Halifax uses mini-plows for clearing sidewalks. They anticipate that this could be a problem with stub poles (i.e., knocking them over), so the use of stub poles is generally avoided.

Other problems are caused by freezing temperatures. Pulling additional wire for a retrofit installation cannot be done in the winter due to ice in the wire conduits. Extreme cold can cause some signals cabinets to fail and thus the APS to fail.

## **EVALUATION**

The initial installations of pedhead-mounted APS installations were configured to give the audible WALK tone at every cycle. The city received complaints about noise, especially in the summer months when people had their windows open. Due to concerns about noise, these units were set to be off (give no audible indication) from 11:00 pm to 6:00 am. The pushbutton-integrated installations, as installed in Halifax, can be accessed 24 hours per day, providing the WALK indication only when the button is held for three seconds or more. No feedback was reported on the pushbutton-integrated devices.

## **CONTACT**

Michael Filippone  
Traffic Signal Supervisor  
City of Halifax, Nova Scotia  
Phone: 902-490-4971  
Email: [filippm@halifax.ca](mailto:filippm@halifax.ca)

# Case Study: Waukesha, Wisconsin

**DATE: APRIL 2005**

## HISTORY AND BACKGROUND

Waukesha has been using pushbutton-integrated APS with speech messages since 2002. Prior to that, they used overhead speaker units which provided a cuckoo or chirp, but were not activated by pushbutton. There are approximately 84 pushbutton-integrated APS in service in Waukesha, most of which were installed during summer 2004. The move to pushbutton-integrated devices was motivated by requests from the local blind community, the Sight Loss Network Support Group, who introduced the city to the speech message capability of new types of APS.

## PROCESS AND PROCEDURE

The initial APS installations were performed in one large campaign in the summer of 2004. These installations were scattered about town, but mainly focused on center city intersections. Another installation campaign is planned, of approximately 100 units, that will focus on installing devices at the rest of the center city intersections, and moving outwards from there. It is also current Waukesha policy that any new signal installation will include APS.

## FUNDING

APS in Waukesha are currently fully funded by Waukesha County Community Development Block Grant Program up to a specified amount per year. This funding includes time and materials.

## APS TYPE AND FEATURES

Pushbutton-integrated devices from Polara Engineering (Navigator four wire devices with remote configuration capability)

APS features:

- Speech WALK indication
- Vibrotactile WALK indication
- Pushbutton locator tone
- Tactile arrow
- Actuation indicator – click and light
- Pushbutton information message, called by extended button press
- Automatic volume adjustment in response to ambient sound

**Figure 9-22. APS mounted on lamp post.**



## INSTALLATION ISSUES

Installation of the devices is done by city staff. If a signal to be retrofitted already has pushbuttons, this greatly facilitates APS installation. However, the four-wire models still necessitate pulling extra wire.

Most of the signal poles are steel and accommodate the APS devices fairly easily. They try to have two poles per corner for every intersection. Sometimes stub poles are necessary, if the signal poles are not close enough to the crosswalk. In one case, a lamp post

was used successfully as a mount for an APS unit (see Figure 9-22), since aesthetics of the area placed restrictions on installing additional poles.

All but one of the existing APS installations were retrofits. However, all new signals will include APS.

## MAINTENANCE

There have been no maintenance issues for the APS units in their one year of service.

## COLD WEATHER ISSUES

There have been no significant issues related cold weather. Waukesha uses mini-plows for removing snow from sidewalks and the manager of city snow plowing has expressed concern that stub poles may be damaged by these plows.

## EVALUATION

Devices in residential areas initially drew noise complaints. The city had been leaving the sound settings at the factory default. Once the volume was reduced, there were no complaints.

## CONTACT

Cheri Shook  
 City of Waukesha, Wisconsin  
 Phone: 262-524-3590  
 Email: [cshook@ci.waukesha.wi.us](mailto:cshook@ci.waukesha.wi.us)

# Case Study: Ann Arbor, Michigan

**DATE: APRIL 2005**

## HISTORY AND BACKGROUND

Ann Arbor has been using pushbutton-integrated APS since 2001. Five were installed that year and none have been added since.

## PROCESS AND PROCEDURE

APS are installed on the basis of recommendations from the Ann Arbor Commission on Disability Issues.

## FUNDING

Approval for APS funding comes through the City Council. The money is budgeted from the Major Street Fund, which is a transportation fund. Currently, \$50,000 is designated for the purchase, installation and maintenance of five APS.

## APS TYPE AND FEATURES

Pushbutton-integrated devices (Navigator) from Polara Engineering

APS features:

- WALK indication—speech message
- Vibrotactile WALK indication
- Pushbutton locator tone
- Tactile arrow
- Actuation indicator—tone and light
- Pushbutton information message called by extended button press
- Automatic volume adjustment in response to ambient sound levels

## INSTALLATION ISSUES

All APS installations were retrofits to existing signals on steel poles, and existing wiring was sufficient to accommodate APS installation. Some units are installed on pedestrian signal poles and some are mounted on the vertical pole of a signal mast arm.



## **MAINTENANCE**

Many of the APS units began to malfunction in 2004 and the city sent them back to the manufacturer for repair/replacement. The problem was observed to be rusting of the devices.

Vandalism was an issue. There were several instances where the unit was knocked off the pole. The attachment bolts were replaced with bigger diameter bolts.

## **COLD WEATHER ISSUES**

Little direct effect was seen from cold weather conditions. However, the use of salt may have contributed to rust that was experienced. The city engineers do not believe that the winter conditions contributed much to the problems.

## **EVALUATION**

There were several complaints about the noise of the locator tones, especially in the summer when people keep windows open. The locator tone volume was lowered in response and where there were two APS units on a single pole, one of the the locator tones was switched off to control noise. To explain how the APS devices work, the city publicized the devices through a newspaper article and local cable broadcast.

## **CONTACT**

Les Sipowski  
Senior Project Manager, City of Ann Arbor Public Services Department  
Ann Arbor, Michigan  
Phone: (734) 996-3286  
Email: LSipowski@ci.ann-arbor.mi.us

# Chapter 10:

## International Practice

### SUMMARY

The information in this chapter is based primarily on visits made by Janet Barlow and Billie Louise Bentzen during 2001 to four countries whose use of APS has been long term, extensive, systematic, and positively accepted by blind pedestrians and traffic engineers.

Many other countries have a long history of using Accessible Pedestrian Signals. This chapter is not an attempt to review all international experience.

### INFORMATION GATHERED

During trips to Japan, Sweden, Australia, and Denmark, the authors met with traffic engineers, orientation and mobility specialists, APS manufacturers and representatives of consumer groups to discuss accessible pedestrian signals. Installations were observed and photographed. At times Barlow and Bentzen, both of whom have unimpaired vision, traveled under blindfold and crossed unfamiliar intersections using typical orientation and mobility techniques and the accessible signals.

### CHAPTER CONTENTS

This chapter summarizes information gathered during visits to the following countries:

Japan .....	204
Australia .....	208
Sweden .....	211
Denmark .....	214



## Japan

### FUNCTIONING OF PEDESTRIAN SIGNALS

#### Pedestrian Signal

- A “red man, green man” signal is used
- Pedestrian signal timing

WALK or “green man” timing is figured based on walking time of 1 meter per second and is calculated to the center line of the intersection.

Flashing DONT WALK timing was reported to be based on a walking speed of 1 meter per second, however this timing seemed to average about 3 seconds regardless of the width of streets.

- Mr. Sugimoto at the Japanese National Police Agency (JPNA), which manages all intersections, stated that intersection timing always includes a pedestrian phase, and at locations with vehicular actuation, pedestrian buttons are provided to lengthen the phase and/or actuate an audible signal.
- Many intersections have pretimed signalization.



**Figure 10-1. “Red man, green man” type signal used in Japan**

### INTERSECTION GEOMETRY

Streets are generally wide. Driving is on the left.

Even where there is a very wide median it is not considered or used as a pedestrian refuge.

Most intersections have pedestrian crosswalks; a fence is typically used where crossing is prohibited.

At areas with high levels of pedestrian traffic, there may be exclusive pedestrian phasing. Most intersections with exclusive pedestrian phasing have audible signals.

Japan has very few non-signalized turn lanes or pork chop type islands.

Tactile Walking Surface Indicators, such as ‘dot tiles’ (called detectable warnings in the US) are ubiquitous in urban areas and have been in use since the 1960s to indicate danger or a need to make a decision. Dot tiles are used in combination with “bar tiles”, a directional surface. Together they provide a continuously demarcated route for pedestrians who are blind.

### NUMBER OF APS

Japan has 170,000 signalized intersections. Of those, 10,570 intersections have APS.

There are a variety of APS systems, most with sound broadcast from the pedestrian signal head (pedhead). A number of melodies and tones are used to indicate

the WALK interval. The tone or melody varies from municipality to municipality; each is allowed to choose its own. JPNA has also developed a receiver-based system called PICS.

- 7,978 intersections have cuckoo or chirp from the pedhead during the WALK interval
- 2,592 intersections have melodies from the pedhead during the WALK interval
- 300 intersections in 20 cities have an infrared APS system (PICS-A) compatible with the Smith-Kettlewell/Talking Signs® standard as developed and evaluated under the direction of JPNA



**Figure 10-2.** At this intersection a chain fence is used where crossing is prohibited, and bar tiles indicate a travel route



**Figure 10-3.** Pedhead with APS speaker is mounted on a mast arm overhanging the crosswalk below

## FUNCTIONING OF BROADCAST APS

### *Cuckoo/chirp*

- Most common sounds for a WALK interval.
- Alternating signal is now the recommended signal and costs a “trivial amount” more than non-alternating. Usually use birdcalls; and are beginning to install alternating signals with different sounds, (chirp and chirp-chirp) on different sides of the street, to improve beaconing.

### *Melody*

- Variety of melodies broadcast into the intersection, with a change in melody during the clearance interval.
- Often quite loud; sometimes possible to hear the melody of one intersection from a block away

### *Speech message*

- Message was “Walk” and the street name in Japanese
- Speaker in the pedestrian signal head may be pointed straight down toward the pedestrian below.

### *Other characteristics*

- Some APS in Tokyo used increased repetition rate of cuckoo or chirp during the clearance interval

**Figure 10-4. Japanese pedhead with APS speaker pointing straight down toward the pedestrian below**



- Very few APS had locator tones at the pushbutton.
- APS may have a sound for the pedestrian clearance interval:
- Yokohama used sound like that of an emergency vehicle
- Fairly common in Tokyo to center the APS speaker over the crosswalk on mast arm extending from the pole
- APS sound is usually turned off at 8:00 pm because residents nearby are bothered by noise.

## FUNCTIONING OF PICS SYSTEM

PICS system is being developed, evaluated and installed under the direction of JPNA.

- Communicates from an infrared transmitter called an “IR station,” and short range radio transmitter installed at the intersection, to a receiver carried by pedestrians.
- There are two types of PICS systems.

**Figure 10-5. The PICS-A system is shown with four infrared transmitters mounted on a horizontal mast arm**



## PICS-A SPEECH SYSTEM

PICS-A speech system provides pedestrian traffic signal information and location information for bus stops and public facilities through a speech message to visually impaired pedestrians. As the traveler approaches within 10 meters of the intersection where the PICS-A system is installed, an FM radio message is received by

the hybrid radio/IR receiver in either a speech or vibration mode. The vibration alerts users to the presence of the transmitted signal. The speech message identifies the intersection. When pedestrians arrive at a corner and are within the crosswalk with the receiver aimed toward the infrared transmitter on the opposite corner, they receive IR-transmitted speech information about the status of the pedestrian signal. A third function extends the pedestrian phase when a button on the receiver is pushed.

## PICS-B IMAGE SYSTEM

The PICS-B image system extends green lights and provides route guidance and information about the surrounding area on a visual display to people with mobility or hearing impairments. Portable receivers (transceivers) are pointed at “IR stations”

located near pedestrian traffic signals to extend the pedestrian signal timing, make emergency contacts, and obtain route guidance and information about the surrounding area. A visual display provides information to the pedestrians.

## COMMENTS

The authors found the variety of overhead speakers loudly broadcasting musical sounds or birdcalls to be confusing and distracting. Although these systems have been in use in Japan for about 40 years, there is growing concern in Japan about the noise pollution they cause.

The PICS-A system provided signal and directional guidance quite efficiently. Radio transmitted information was useful for general intersection information on approach. A large array of transmitters is required for this system, as shown in Figure 10-5.

- A head-mounted receiver has now been developed by Mitsubishi Precision Corp. Barlow and Bentzen used this receiver at one intersection and found it effective.
- The standard receiver is hand-held and can hang on a neck cord or be put in a pocket when not in use.

## SOURCES OF INFORMATION

Kunio Kurachi, Mitsubishi Precision Co., Ltd, Tokyo

Takabun Nakamura, Okayama Prefectural University, Okayama

Hirohiko Ohkubo, Mitsubishi Precision Co., Ltd., Tokyo

Michiko Shimizu, Orientation and Mobility Specialist, Tokyo

Osamu Sueda, Rehabilitation Engineering Society of Japan and University of Tokushima

Mikio Sugimoto, National Police Agency, Government of Japan, Tokyo

Masaki Tauchi, Okayama Prefectural University, Okayama



## Australia

### FUNCTIONING OF PEDESTRIAN SIGNALS

#### *Pedestrian signals*

- Red and green man signals with the red man flashing during flashing DONT WALK interval
- All pedestrian pushbuttons were located in very standardized locations, on the side of the crosswalk away from the parallel street, aligned with the crosswalk line, about 0.5 to 1.0 m from the curb line. Most fixed timed intersections in downtown Sydney had pushbuttons with audible and vibrotactile features.

#### *Pedestrian signal timing*

- WALK and flashing DONT WALK were similar to the US system, with clearance interval timed at 1 meter per second.

**Figure 10-6. Signalized left turn lane with APS mounted close to the crosswalk locations. Three APS are on the splitter island, one for each crossing.**



### INTERSECTION GEOMETRY

Streets can be wide and complex, sometimes having narrow medians and channelized turn lanes, which were signalized in some locations.

Roundabouts are used extensively and orientation and mobility specialists and blind travelers state that roundabouts are a barrier to travel.

Detectable warnings or “TWSI’s” (tactile walking indicators) are used to define the edge of the street on the curb ramp, but not consistently installed from state to state. The edge of the TWSI is intended to be aligned perpendicularly to the crosswalk direction; this is intended to provide additional directional information to blind pedestrians.

### NUMBER OF APS

Each state is responsible for its own area.

Overall number was not available.

APS have been fairly extensively installed in areas where there is pedestrian traffic since the 1980s.

## APS FUNCTIONING

Pushbutton integrated type of signal is used. The pushbutton and sound are standardized nationally.

There are several APS manufacturers in the Australian market but the pole mounted control box overhead was the only visible difference. All pushbuttons looked identical, whether they had APS or not, except that those with APS features had an additional raised bar on the arrow to indicate that they had APS. All pushbuttons with audio-tactile features functioned identically.



**Figure 10-7.** This APS has a tactile arrow within a larger visible arrow. A raised bar on the tactile arrow indicates that this is an APS. Other features include a locator tone and audible and vibrotactile WALK indication.

## LOCATOR TONE

Locator tone has a repetition rate of once every 2 seconds.

WALK indicator:

- Fast repetition of low frequency thumping sound during the WALK interval.
- May have the capability to be set so that the WALK sound is limited to 8 seconds even when the WALK indication is longer.

Alert tone: “Alert tone” at the beginning of the WALK indication is set to sound at 14 db above ambient.

- All devices respond to ambient sound, both for the locator tone and the WALK indication.
- Vibrotactile information at the arrow panel pulses at the same rate as the audible tone.
- Placement has been standardized at line of the crosswalk away from the center of the intersection. Orientation of face of the APS varied; see photo 4-9. Speaker for the APS is the face of the arrow so sound is emanating from face of unit. Orientation of the device can make a difference in hearing the APS when approaching or from the street.

## ADDITIONAL INFORMATION

- All devices respond to ambient sound, both for the locator tone and the WALK indication.
- Vibrotactile information at the arrow panel pulses at the same rate as the audible tone.



**Figure 10-8. Typical APS location in relation to the crosswalk and sidewalk.**

Australian curb ramp standards allow a steeper slope than allowed by US standards.



- Placement has been standardized at line of the crosswalk away from the center of the intersection. Orientation of face of the APS varied; see photo 4-9. Speaker for the APS is the face of the arrow so sound is emanating from face of unit. Orientation of the device can make a difference in hearing the APS when approaching or from the street.
- APS are sometimes turned off at night due to neighbors' complaints about noise.

**Figure 10-9. Installation of tactile arrows was not consistent and provided misleading information in some cases**



## COMMENTS

The standard location of the pushbutton, with each pushbutton located beside the waiting location for the crossing, provided a clear indication of which crossing the APS was indicating. There was no need for different sounds for different directions

of travel. Even on pork chop type islands with three devices sounding, it was possible to distinguish the location and crossing being signaled.

## SOURCES OF INFORMATION

George Carnazolla, Transport SA, Adelaide

Gayle Clark, Orientation and Mobility Specialist, Guide Dogs Association of SA and NT, Inc., Adelaide

Susan Lockhart, Orientation and Mobility Specialist, Sydney

Murray Mountain, Access Design Solutions, Melbourne

Bob and Jelena Panich, Bob Panich Consultancy, Ryde (Sydney)

Stephen Purtill, Specifications and Standards, VIC Roads, Melbourne

John Samperi, Signal Engineer

Roley Stuart, Client Services Manager, Guide Dogs Association of SA and NT, Inc., Adelaide

Jack Vankuyk, Traffic Signals Supervisor, RTA Operations, Sydney

# Sweden

## FUNCTIONING OF PEDESTRIAN SIGNALS

### *Pedestrian Signals*

- Sweden uses a “red man, green man” symbol signal.
- Use of a flashing or clearance interval seems to be a local decision. In Göteborg, there is no flashing interval, while in Skövda, a flashing ‘red man’ is used. Pedestrian actuation is common and the location of the pushbutton is fairly standard, approximately .5-1.0 m from the curb line and near the farthest crosswalk line from the center of the intersection.

### *Pedestrian Signal Timing*

- Pedestrians rarely had to cross more than two lanes without coming to an island or median.
- WALK interval is timed according to the width of the street using 1 meter per second, with a change interval of about 4 seconds.

## INTERSECTION GEOMETRY

In cities, streets were generally narrow, with lots of islands. In general, medians or islands separated traffic. Most channelized turn lanes were signalized.

Arterials typically have bicycle lanes on both sides of the street. Bicycle lanes are usually signalized separately, using small ball signals and separate pushbutton actuation.

There are no curb ramps as such; all curbs at corners are typically 3-4 cm high, which is said to be acceptable to persons with mobility impairments.

## NUMBER OF APS

Overall number was not available.

APS are fairly extensively installed in downtown areas. In suburban areas, signals are installed at the request of persons who are blind or visually impaired and may be installed only on some crosswalks of the intersection, depending on the request.

APS have been in use in Sweden since the 1960s.



**Figure 10-10.** This intersection in Göteborg, Sweden has a bike lane (seen on left side of photo) with its own signal head, and an APS that is mounted on the same pole

**Figure 10-11.** This street crossing in Göteborg, Sweden, includes two islands and numerous APS (located in the photo by circles or half-circles)



**Figure 10-12.** The Swedish APS displays a tactile map on one side



**Figure 10-13.** A pedestrian uses the tactile map



## APS FUNCTIONING

There is no Swedish standard for APS, but most APS have a ticking sound that repeats at 60 pulses per minute for the locator tone and 600 per minute for the WALK interval.

The APS is typically placed on a signal pole or stub pole near the edge of the crosswalk furthest from the intersection, about 0.5 meters from the curb.

Signal volume is typically set to be audible 3 meters from the pole. Signals respond to ambient sound, within a range set by the installer. APS can also be set to a constant volume.

Each intersection had a number of APS and pedestrian signal heads because there was an APS on each island/median; many medians had an additional pedhead as well.

APS is differentiated from standard pedestrian pushbutton by different colored panels on the side of the device.

A raised tactile arrow on top of the device points across the crosswalk.

At median locations where the signal

actuated a simultaneous WALK for pedestrians crossing in both directions from the median, arrowheads were on both ends of the shaft.

Signals were of a type that could include vibrotactile information through a separate button on the bottom of the device. However, that feature was not commonly provided.

## ADDITIONAL INFORMATION

Most devices had a crosswalk map feature on the side of the device, indicating the number of vehicular or bicycle lanes to be crossed, and where present, the locations of islands or transit rails across the crosswalk. However, Kaj Nordquist of the Swedish Blind Association, stated that most blind people in Sweden only traveled on familiar routes so the tactile maps were not used much. He stated that orientation to new routes is generally available to blind citizens of Sweden.

## COMMENTS

Although there were a number of APSs at each intersection, it was possible to locate the devices, and use the WALK indication of the device to cross efficiently.

Because of the precise location of each APS, the information provided was unambiguous as to which crosswalk had the WALK interval.

A pedestrian waiting to cross could always be within arm's reach of the APS, so there was no question regarding which APS was sounding during the WALK interval.

## SOURCES OF INFORMATION

Jan Lund, Prisma Teknik, Tibro

Roger Peterson, Prisma Teknik, Tibro

Bengt Ekdahl, Traffic Engineering, Göteborg

Kaj Nordquist, Swedish Blind Society, Stockholm



## Denmark

### FUNCTIONING OF PEDESTRIAN SIGNALS

#### *Pedestrian Signals*

Red man, green man symbol

#### *Pedestrian Signal Timing*

Length of the WALK interval varies by time of day. WALK interval usually calculated using a walking speed formula of 1.3 meters per second, but up to 1.5 meters per second can be used.

No flashing clearance interval

Fixed timed signals in most of central business district

**Figure 10-14.** Illustration of tactile arrow



### INTERSECTION GEOMETRY

Streets typically were narrow (by US standards) with a great deal of pedestrian and bicycle traffic. Streets included wide bike lanes, often slightly raised from the street level.

No unsignalized right turn lanes for cars, but there are right turn lanes for bicycles.

Curbs are typically 3–4 cm high, which is said to be acceptable to persons with mobility impairments.

Detectable warning surfaces installed in some locations at the curb, usually in a one-foot band. No detectable warnings at edges of cut-through medians.

**Figure 10-15.** The tactile arrow on the APS in Denmark was on top of the device which was located on a pole near the crosswalk line. Most intersections were pretimed so no pushbutton was included on this device.



### NUMBER OF APS

Very common in central business districts; outside of central business districts APS are installed at the request of the Danish Blind Association and only at requested crosswalks of the intersections.

## APS FUNCTIONING

Most installations have audible signals coming from devices at pushbutton height, whether they have pushbuttons or the signals are fixed timed; overhead beaconing speaker devices are currently installed in combination with pushbutton locator tones at a few trial locations.

Signals must conform to a national standard.

Locator tone and WALK indication

- Both are 880 Hz square or saw-tooth wave tones. Locator tone is pulsed at 30/minute and WALK indication pulsed faster.
- The Danish standard requires that the WALK indication be five times the rate of the locator tone.
- The pulse length of the locator tone is 400 ms and the pulse length of the WALK tone is 200 ms.

### *Volume*

- All APS respond to ambient sound, unless special permission is received to set the signal to a constant low level.
- Although the standard for setting the volume is that the signal should be audible 3 meters from the pole, the signal was quite often audible as far as 10 meters from the pole.
- The installer determines volume by listening.

## ADDITIONAL INFORMATION

### *Location*

- Located consistently at the end of the crosswalk line so locator tone could be used to line up for crossing.
- Consistency of location is considered very important; the APS is installed no more than 0.6 meter from the curb line and the horizontal distance from the crosswalk line is not more than 0.3 m.
- Stub poles are installed if signal poles are not available in the appropriate location.

### *Crosswalk information*

- A knob on the end of the bar indicates the far side of the street and additional knobs indicate the number of islands or medians that will be encountered prior to the far side.
- All APS devices have a bar aligned with the crosswalk, functioning as an arrow, on top of the device.

**Figure 10-16. Danish APS with tactile bar (arrow) mounted on the top. The bar is aligned with the crosswalk, and two knobs at the end of the bar indicate a median and the far side of the street.**



### *Other*

- Where there is a pushbutton, it is usually located on the backside of the APS, toward the pole, with sufficient space for fingers to reach between the APS and the pole.
- In general there is no need to push a button, as most intersections have pre-timed pedestrian phases.

### **COMMENT**

Locator tone was same tone as the WALK interval tone, and at the same intensity. Repetition rates at some locations in Copenhagen did not seem to conform to the published standard.

At a multi-leg intersection, the APS were very usable for crossing and alignment.

- APS were very consistently located in relation to the crosswalk.
- Directional bar (arrow) was useful, as were crosswalk maps on the side of the signals.
- Medians were cut-through, without detectable warnings, but the sound of the APS on the median gave some information about the median location.

The representative of the Danish Blind Association mentioned concerns of some people that the signals were too loud, causing noise pollution.

### **CONTACT**

Mohammed Abazza, Traffic Engineer, Copenhagen

Neils Christian Johanneson, Siemens

Inge Kyhl, Orientation and Mobility Specialist, Institute for the Blind and Partially Sighted in Denmark

Mehta Rohe, Danish Blind Association

Jørn Vammen, Signals Engineer, Danish Department of Transportation

# Appendix A: Current Guidelines

## Introduction

For the convenience of the reader, this appendix contains excerpts from the MUTCD (current and proposed language) and Draft PROWAG concerning guidance on accessible pedestrian signals. The organization of this appendix is as follows:

<b>DOCUMENT</b>	<b>DATED</b>	<b>SECTIONS INCLUDED IN THIS APPENDIX</b>	<b>STARTING PAGE IN THIS APPENDIX</b>
MUTCD 2003	November 2004	sections 4D.03, 4E.06, and 4E.09	218
Proposed Amendments to the MUTCD Relevant to APS	January 2008	sections 4A.02, 4D.03, 4E.06, 4E.08, and 4E.09	225
Draft PROWAG	November 23, 2005	Chapters R1 through R4	238



## **Excerpts from MUTCD — 2003 Edition with Revision No. 1 Incorporated, dated November 2004**

### **SECTION 4D.03 PROVISIONS FOR PEDESTRIANS**

#### *Support:*

Chapter 4E contains additional information regarding pedestrian signals.

#### *Standard:*

**The design and operation of traffic control signals shall take into consideration the needs of pedestrian as well as vehicular traffic.**

**If engineering judgment indicates the need for provisions for a given pedestrian movement, signal faces conveniently visible to pedestrians shall be provided by pedestrian signal heads or a signal face for an adjacent vehicular movement.**

#### *Guidance:*

Safety considerations should include the installation, where appropriate, of accessible pedestrian signals (see Sections 4E.06 and 4E.09) that provide information in nonvisual format (such as audible tones, verbal messages, and/or vibrating surfaces).

Where pedestrian movements regularly occur, pedestrians should be provided with sufficient time to cross the roadway by adjusting the traffic control signal operation and timing to provide sufficient crossing time every cycle or by providing pedestrian detectors.

#### *Option:*

If it is desirable to prohibit certain pedestrian movements at a traffic control signal, a PEDESTRIANS PROHIBITED (R9-3) or No Pedestrian Crossing (R9-3a) sign may be used (see Section 2B.44).

### **SECTION 4E.06 ACCESSIBLE PEDESTRIAN SIGNALS**

#### *Support:*

The primary technique that pedestrians who have visual disabilities use to cross streets at signalized locations is to initiate their crossing when they hear the traffic in front of them stop and the traffic alongside them begin to move, corresponding to the onset of the green interval. This technique is effective at many signalized locations. The existing environment is often sufficient to provide the information

that pedestrians who have visual disabilities need to operate reasonably safely at a signalized location. Therefore, many signalized locations will not require any accessible pedestrian signals.

### ***Guidance:***

If a particular signalized location presents difficulties for pedestrians who have visual disabilities to cross reasonably safely and effectively, an engineering study should be conducted that considers the safety and effectiveness for pedestrians in general, as well as the information needs of pedestrians with visual disabilities.

### ***Support:***

The factors that might make crossing at a signalized location difficult for pedestrians who have visual disabilities include: increasingly quiet cars, right turn on red (which masks the beginning of the through phase), continuous right-turn movements, complex signal operations, traffic circles, and wide streets. Further, low traffic volumes might make it difficult for pedestrians who have visual disabilities to discern signal phase changes.

Local organizations, providing support services to pedestrians who have visual and/or hearing disabilities, can often act as important advisors to the traffic engineer when consideration is being given to the installation of devices to assist such pedestrians. Additionally, orientation and mobility specialists or similar staff also might be able to provide a wide range of advice. The U.S. Access Board's Document A-37, "Accessible Pedestrian Signals," provides various techniques for making pedestrian signal information available to persons with visual disabilities (see Addresses for the address for the U.S. Access Board).

Accessible pedestrian signals provide information in nonvisual format (such as audible tones, verbal messages, and/or vibrating surfaces).

Information regarding detectors for accessible pedestrian signals is found in Section 4E.09.

### ***Standard:***

**When used, accessible pedestrian signals shall be used in combination with pedestrian signal timing. The information provided by an accessible pedestrian signal shall clearly indicate which pedestrian crossing is served by each device.**

**Under stop-and-go operation, accessible pedestrian signals shall not be limited in operation by the time of day or day of week.**

### ***Guidance:***

The installation of accessible pedestrian signals at signalized locations should be based on an engineering study, which should consider the following factors:

- A. Potential demand for accessible pedestrian signals;
- B. A request for accessible pedestrian signals;
- C. Traffic volumes during times when pedestrians might be present, including periods of low traffic volumes or high turn-on-red volumes;
- D. The complexity of traffic signal phasing; and
- E. The complexity of intersection geometry.

***Support:***

Technology that provides different sounds for each nonconcurrent signal phase has frequently been found to provide ambiguous information.

***Standard:***

**When choosing audible tones, possible extraneous sources of sounds (such as wind, rain, vehicle back-up warnings, or birds) shall be considered in order to eliminate potential confusion to pedestrians who have visual disabilities.**

***Guidance:***

Audible pedestrian tones should be carefully selected to avoid misleading pedestrians who have visual disabilities when the following conditions exist:

- A. Where there is an island that allows unsignalized right turns across a crosswalk between the island and the sidewalk.
- B. Where multileg approaches or complex signal phasing require more than two pedestrian phases, such that it might be unclear which crosswalk is served by each audible tone.
- C. At intersections where a diagonal pedestrian crossing is allowed, or where one street receives a WALKING PERSON (symbolizing WALK) signal indication simultaneously with another street.

***Standard:***

**When accessible pedestrian signals have an audible tone(s), they shall have a tone for the walk interval. The audible tone(s) shall be audible from the beginning of the associated crosswalk. If the tone for the walk interval is similar to the pushbutton locator tone, the walk interval tone shall have a faster repetition rate than the associated pushbutton locator tone.**

***Support:***

A pushbutton locator tone is a repeating sound that informs approaching pedestrians that they are required to push a button to actuate pedestrian timing, and that enables visually impaired pedestrians to locate the pushbutton (see Section 4E.09).

### ***Guidance:***

The accessible walk signal tone should be no louder than the locator tone, except when there is optional activation to provide a louder signal tone for a single pedestrian phase.

Automatic volume adjustment in response to ambient traffic sound level should be provided up to a maximum volume of 89 dBA. Where automatic volume adjustment is used, tones should be no more than 5 dBA louder than ambient sound. The A-weighted sound pressure level should conform to the requirements of “ISO 1996-1:1982” and “ISO 1996-2:1987” (see Addresses for the address for the International Organization for Standards).

### ***Standard:***

**When verbal messages are used to communicate the pedestrian interval, they shall provide a clear message that the walk interval is in effect, as well as to which crossing it applies.**

**The verbal message that is provided at regular intervals throughout the timing of the walk interval shall be the term “walk sign,” which may be followed by the name of the street to be crossed.**

**A verbal message is not required at times when the walk interval is not timing, but, if provided:**

- A. It shall be the term “wait.”**
- B. It need not be repeated for the entire time that the walk interval is not timing.**

### ***Option:***

Accessible pedestrian signals that provide verbal messages may provide similar messages in languages other than English, if needed, except for the terms “walk sign” and “wait.”

### ***Support:***

A vibrotactile pedestrian device communicates information about pedestrian timing through a vibrating surface by touch.

### ***Standard:***

**Vibrotactile pedestrian devices, where used, shall indicate that the walk interval is in effect, and for which direction it applies, through the use of a vibrating directional arrow or some other means.**

### ***Guidance:***

When provided, vibrotactile pedestrian devices should be located next to, and on the same pole as, the pedestrian pushbutton, if any, and adjacent to the intended crosswalk.

## SECTION 4E.09 ACCESSIBLE PEDESTRIAN SIGNAL DETECTORS

### *Standard:*

**An accessible pedestrian signal detector shall be defined as a device designated to assist the pedestrian who has visual or physical disabilities in activating the pedestrian phase.**

**At accessible pedestrian signal locations with pedestrian actuation, each pushbutton shall activate both the walk interval and the accessible pedestrian signals.**

### *Option:*

Accessible pedestrian signal detectors may be pushbuttons or passive detection devices.

Pushbutton locator tones may be used with accessible pedestrian signals.

### *Guidance:*

At accessible pedestrian signal locations, pushbuttons should clearly indicate which crosswalk signal is actuated by each pushbutton. Pushbuttons and tactile arrows should have high visual contrast as described in the “Americans with Disabilities Act Accessibility Guidelines for Buildings and Facilities (ADAAG)” (see Section 1A.11). Tactile arrows should point in the same direction as the associated crosswalk. At corners of signalized locations with accessible pedestrian signals where two pedestrian pushbuttons are provided, the pushbuttons should be separated by a distance of at least 3 m (10 ft). This enables pedestrians who have visual disabilities to distinguish and locate the appropriate pushbutton.

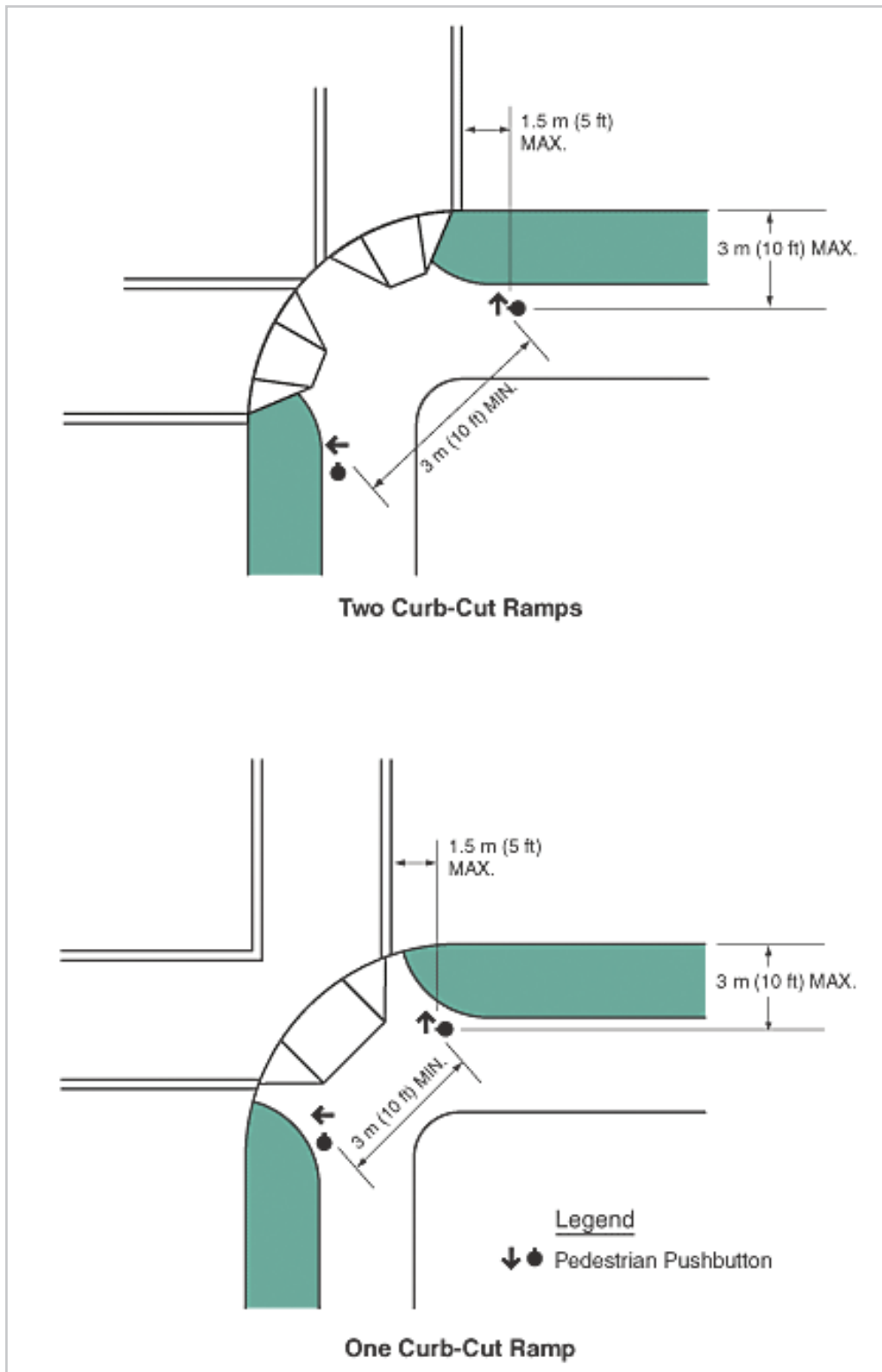
Pushbuttons for accessible pedestrian signals should be located (see Figure 4E-2) as follows:

- A. Adjacent to a level all-weather surface to provide access from a wheelchair, and where there is an all-weather surface, wheelchair accessible route to the ramp;
- B. Within 1.5 m (5 ft) of the crosswalk extended;
- C. Within 3 m (10 ft) of the edge of the curb, shoulder, or pavement; and
- D. Parallel to the crosswalk to be used.

If the pedestrian clearance time is sufficient only to cross from the curb or shoulder to a median of sufficient width for pedestrians to wait and accessible pedestrian detectors are used, an additional accessible pedestrian detector should be provided in the median.

### *Standard:*

**When used, pushbutton locator tones shall be easily locatable, shall have a duration of 0.15 seconds or less, and shall repeat at 1-second intervals.**



**Figure 4E-2 Recommended Pushbutton Locations for Accessible Pedestrian Signals**

**Guidance:**

Pushbuttons should be audibly locatable. Pushbutton locator tones should be intensity responsive to ambient sound, and be audible 1.8 to 3.7 m (6 to 12 ft) from the pushbutton, or to the building line, whichever is less. Pushbutton locator tones should be no more than 5 dBA louder than ambient sound.

Pushbutton locator tones should be deactivated during flashing operation of the traffic control signal.

***Option:***

At locations with pretimed traffic control signals or nonactuated approaches, pedestrian pushbuttons may be used to activate the accessible pedestrian signals.

The audible tone(s) may be made louder (up to a maximum of 89 dBA) by holding down the pushbutton for a minimum of 3 seconds. The louder audible tone(s) may also alternate back and forth across the crosswalk, thus providing optimal directional information.

The name of the street to be crossed may also be provided in accessible format, such as Braille or raised print.

## **Proposed Amendments to the MUTCD Relevant to APS**

On January 2, 2008, the Federal Highway Administration published in the Federal Register a Notice of Proposed Amendments (NPA) to the MUTCD. This NPA contains comprehensive revisions that are proposed for incorporation into the next edition of the MUTCD. A 7-month period was provided for comments to the docket, which closed on July 31, 2008. The FHWA is currently [at the time of this publication] reviewing and analyzing the comments received. A Final Rule for the next edition of the MUTCD is anticipated during 2009.

The sections shown below are taken from the proposed MUTCD text and are the relevant sections for Accessible Pedestrian Signals.

### **SECTION 4A.02 DEFINITIONS RELATING TO HIGHWAY TRAFFIC SIGNALS (PARTIAL)**

#### *Standard:*

The following technical terms, when used in Part 4, shall be defined as follows:

1. **Accessible Pedestrian Signal**—a device that communicates information about pedestrian timing in nonvisual format such as audible tones, speech messages, and/or vibrating surfaces.

### **SECTION 4D.03 PROVISIONS FOR PEDESTRIANS**

#### *Support:*

Chapter 4E contains additional information regarding pedestrian signals and Chapter 4F contains additional information regarding pedestrian hybrid signals.

#### *Standard:*

**The design and operation of traffic control signals shall take into consideration the needs of pedestrian as well as vehicular traffic.**

**If engineering judgment indicates the need for provisions for a given pedestrian movement, signal faces conveniently visible to pedestrians shall be provided by pedestrian signal heads (see Chapter 4E) or a vehicular signal face(s) for a concurrent vehicular movement.**



***Guidance:***

Accessible pedestrian signals (see Sections 4E.06 and 4E.09) that provide information in nonvisual formats (such as audible tones, speech messages, and/or vibrating surfaces) should be provided where determined appropriate by engineering judgment.

Where pedestrian movements regularly occur, pedestrians should be provided with sufficient time to cross the roadway by adjusting the traffic control signal operation and timing to provide sufficient crossing time every cycle or by providing pedestrian detectors.

If it is necessary or desirable to prohibit certain pedestrian movements at a traffic control signal location, No Pedestrian Crossing (R9-3) signs (see Section 2B.58) should be used if the pedestrian movements are not physically prevented by barriers or other physical features.

**SECTION 4E.06 ACCESSIBLE PEDESTRIAN SIGNALS*****Support:***

The primary technique that pedestrians who have visual disabilities use to cross streets at signalized locations is to initiate their crossing when they hear the traffic in front of them stop and the traffic alongside them begin to move, which often corresponds to the onset of the green interval. The existing environment is often not sufficient to provide the information that pedestrians who have visual disabilities need to cross a roadway at a signalized location.

***Guidance:***

If a particular signalized location presents difficulties for pedestrians who have visual disabilities to cross the roadway, an engineering study should be conducted that considers the needs of pedestrians in general, as well as the information needs of pedestrians with visual disabilities. The engineering study should consider the following factors:

- A. Potential demand for accessible pedestrian signals;
- B. A request for accessible pedestrian signals;
- C. Traffic volumes during times when pedestrians might be present, including periods of low traffic volumes or high turn-on-red volumes;
- D. The complexity of traffic signal phasing (such as split phases, protected turn phases, leading pedestrian intervals, and exclusive pedestrian phases); and
- E. The complexity of intersection geometry.

***Support:***

The factors that make crossing at a signalized location difficult for pedestrians who have visual disabilities include: increasingly quiet cars, right turn on red (which masks the beginning of the through phase), continuous right-turn movements, complex signal operations, traffic circles, and wide streets. Furthermore, low traffic volumes might make it difficult for pedestrians who have visual disabilities to discern signal phase changes.

Local organizations, providing support services to pedestrians who have visual and/or hearing disabilities, can often act as important advisors to the traffic engineer when consideration is being given to the installation of devices to assist such pedestrians. Additionally, orientation and mobility specialists or similar staff also might be able to provide a wide range of advice. The U.S. Access Board ([www.access-board.gov](http://www.access-board.gov)) provides various techniques for making pedestrian signal information available to persons with visual disabilities (see Page i for the address for the U.S. Access Board).

Accessible pedestrian signals provide information in nonvisual format (such as audible tones, speech messages, and/or vibrating surfaces). Information regarding detectors for accessible pedestrian signals is found in Section 4E.09.

***Standard:***

**When used, accessible pedestrian signals shall be used in combination with pedestrian signal timing.**

**The information provided by an accessible pedestrian signal shall clearly indicate which pedestrian crossing is served by each device.**

**Under stop-and-go operation, accessible pedestrian signals shall not be limited in operation by the time of day or day of week.**

***Support:***

Accessible pedestrian signals that are located as close as possible to pedestrians waiting to cross the street provide the clearest and least ambiguous indication of which pedestrian crossing is served by a device.

Technology that provides different sounds for each nonconcurrent signal phase has frequently been found to provide ambiguous information.

Research indicates that a rapid tick tone for each crossing on separated poles located close to each crosswalk provides unambiguous information to pedestrians who are blind or visually impaired. Vibrotactile indications provide information to pedestrians who are blind and deaf and are also used by pedestrians who are blind or who have low vision to confirm the walk signal in noisy situations.

### ***Standard:***

**Accessible pedestrian signals shall have both audible and vibrotactile walk indications.**

**Accessible pedestrian signals shall have an audible walk indication during the walk interval only.**

**The audible tone(s) shall be audible from the beginning of the associated crosswalk.**

**Accessible pedestrian signals shall not provide an audible pedestrian change interval indication.**

**Audible walk indications shall be a percussive tone. Audible tone walk indications shall repeat at 8 to 10 ticks per second. Audible tones used as walk indications shall consist of multiple frequencies with a dominant component at 880 Hz.**

**Vibrotactile walk indications shall be provided by a tactile arrow on the pushbutton that vibrates during the walk interval (see Section 4E.09).**

### ***Guidance:***

The sound level of audible pedestrian indications should be adjusted to be low enough to avoid misleading pedestrians who have visual disabilities when the following conditions exist:

- A. Where there is an island that allows unsignalized right turns across a crosswalk between the island and the sidewalk.
- B. Where multileg approaches or complex signal phasing require more than two pedestrian phases, such that it might be unclear which crosswalk is served by each audible tone.
- C. At intersections where a diagonal pedestrian crossing is allowed, or where one street receives a WALKING PERSON (symbolizing WALK) signal indication simultaneously with another street.

### ***Support:***

A pushbutton locator tone is a repeating sound that informs approaching pedestrians that a pushbutton to actuate pedestrian timing or receive additional information exists, and that enables pedestrians who have visual disabilities to locate the pushbutton (see Section 4E.09).

### ***Standard:***

**Tones shall be set to be no more than 5 dBA louder than ambient sound except when a louder signal is provided in response to an extended button press. Automatic volume adjustment in response to ambient traffic sound level shall be provided up to a maximum volume of 100 dBA.**

**The accessible walk signal shall have the same duration as the pedestrian walk signal except when the pedestrian signal rests in walk.**

### *Guidance:*

If the pedestrian signal rests in walk, the accessible walk signal should be limited to the first 7 seconds of the walk interval. The accessible walk signal should be recalled by a button press during the walk interval provided that the crossing time remaining is greater than the pedestrian change interval.

### *Option:*

An alert tone, which is a very brief burst of high-frequency sound at the beginning of the audible walk indication that rapidly decays to the frequency of the walk tone, may be used to alert pedestrians to the beginning of the walk interval. An alert tone may be particularly useful if the walk tone is not easily audible in some traffic conditions.

### *Support:*

Speech messages communicate to pedestrians which street has the walk interval. Speech messages might be either directly audible or transmitted, requiring a personal receiver to hear the message. To be a useful system, the words and their meaning must be correctly understood by all users in the context of the street environment where they are used. Because of this, tones are the preferred means of providing audible walk indications.

If speech messages are used, pedestrians have to know the names of the streets that they are crossing in order for the speech walk messages to be unambiguous. In getting directions to travel to a new location, pedestrians who are blind do not always get the name of each street to be crossed. Therefore, it is desirable to give users of accessible pedestrian signals the name of the street controlled by the pushbutton. This can be done by means of a speech pushbutton information message during the flashing or steady don't walk intervals, or by raised print and Braille labels on the pushbutton housing.

By combining the information from the pushbutton message or Braille label, the tactile arrow aligned in the direction of travel on the relevant crosswalk, and the speech walk message, pedestrians with visual disabilities are able to correctly respond to speech walk messages even if there are two pushbuttons on the same pole.

### *Standard:*

**If speech messages are used to communicate the pedestrian interval, they shall provide a clear message that the walk interval is in effect, as well as to which crossing it applies. Speech walk messages shall be used only at intersections where it is technically infeasible to install two accessible pedestrian signals at one corner separated by a distance of at least 3 m (10 ft).**

**Speech messages that are used at intersections having pedestrian phasing that is concurrent with vehicular phasing shall be patterned after the model: “Broadway. Walk sign is on to cross Broadway.”**

**Speech messages that are used at intersections having exclusive pedestrian phasing shall be patterned after the model: “Walk sign is on for all crossings.”**

**Walk interval messages shall not contain any additional information, except they shall include designations such as “Street” or “Avenue” where this information is necessary to avoid ambiguity at a particular location.**

### ***Guidance:***

Speech messages should not state or imply a command to the pedestrian, such as “Cross Broadway now.”

Speech messages should not tell pedestrians that it is “safe to cross,” because it is always the pedestrian’s responsibility to check actual traffic conditions.

### ***Standard:***

**A speech message is not required at times when the walk interval is not timing, but, if provided:**

- A. A. It shall begin with the term “wait.”
- B. B. It need not be repeated for the entire time that the walk interval is not timing.

### ***Support:***

Section 4E.09 contains additional information regarding speech pushbutton information messages when the walk interval is not timing.

### ***Option:***

Accessible pedestrian signals that provide speech messages may provide similar messages in languages other than English, if needed, except for the terms “walk sign” and “wait.”

Pedestrians may be provided with additional features such as increased crossing time, audible beaconing, or a pushbutton information message as a result of an extended pushbutton press.

### ***Standard:***

**If an extended pushbutton press is used to provide any additional feature(s), a pushbutton press of less than one second shall actuate only the pedestrian timing and any associated accessible walk signal, and a pushbutton press of one second or**

**more shall actuate the pedestrian timing, any associated accessible walk signal, and any additional feature(s).**

### ***Support:***

Audible beaconing is the use of an audible signal in such a way that blind pedestrians can home in on the signal from the target corner as they cross the street.

Not all crosswalks at an intersection need audible beaconing; audible beaconing can actually cause confusion if used at all crosswalks at some intersections. Audible beaconing is not appropriate at locations with channelized turns or split phasing, because of the possibility of confusion.

### ***Guidance:***

Audible beaconing should only be considered following an engineering study at:

- A. Crosswalks longer than 21 m (70 ft), unless they are divided by a median that has another accessible pedestrian signal with a locator tone;
- B. Crosswalks that are skewed;
- C. Intersections with irregular geometry, such as multiple legs;
- D. Crosswalks where audible beaconing is requested by an individual with visual disabilities; or
- E. Other locations where a study indicates audible beaconing would be beneficial.

### ***Option:***

Audible beaconing may be provided in several ways, any of which are initiated by an extended pushbutton press.

### ***Standard:***

**If audible beaconing is used, the volume of the locator tone during the pedestrian change interval of the called pedestrian phase shall be increased and operated in one of the following ways:**

- A. **The louder audible walk indication and louder locator tone comes from the target corner, as pedestrians cross the street,**
- B. **The louder locator tone comes from both ends of the crosswalk, or**
- C. **The louder locator tone comes from an additional speaker that is aimed at the center of the crosswalk and that is mounted on a pedestrian signal head.**

## SECTION 4E.08 PEDESTRIAN DETECTORS

### *Option:*

Pedestrian detectors may be pushbuttons or passive detection devices.

### *Support:*

The provisions in this Section place pedestrian pushbuttons within easy reach of pedestrians who are intending to cross each crosswalk and make it obvious which pushbutton is associated with each crosswalk. These provisions also position pushbutton poles in optimal locations for installation of accessible pedestrian

signals. Information regarding reach ranges can be found in the “Americans with Disabilities Act Accessibility Guidelines for Buildings and Facilities (ADAAG)” (see Section 1A.11).

### *Standard:*

**If pedestrian pushbuttons are used, they shall be capable of easy activation and conveniently located near each end of the crosswalks. Except as noted in the Guidance below, pedestrian pushbuttons shall be located to meet all of the following criteria (see Figure 4E-2):**

- A. Unobstructed and adjacent to a level all-weather surface to provide access from a wheelchair;
- B. Where there is an all-weather surface, a wheelchair accessible route from the pushbutton to the ramp;
- C. Between the edge of the crosswalk line (extended) farthest from the center of the intersection and the side of a curb ramp (if present), but not greater than 1.5 m (5 ft) from said crosswalk line;
- D. Between 0.45 m (1.5 ft) and 1.8 m (6 ft) from the edge of the curb, shoulder, or pavement;
- E. With the face of the pushbutton parallel to the crosswalk to be used; and
- F. At a maximum mounting height of 1.2 m (4 ft) above the sidewalk.

### *Guidance:*

Where there are constraints that make it impractical to place the pedestrian pushbutton adjacent to a level all-weather surface, the surface should be as level as feasible.

Where there are constraints that make it impractical to place the pedestrian pushbutton between 0.45 m (1.5 ft) and 1.8 m (6 ft) from the edge of the curb, shoulder, or pavement, it should not be farther than 3 m (10 ft) from the edge of curb, shoulder, or pavement. A mounting height of approximately 1.1 m (3.5 ft) above the sidewalk should be used for pedestrian pushbuttons.

Except as noted in the Option below, where two pedestrian pushbuttons are provided on the same corner of a signalized location, the pushbuttons should be separated by a distance of at least 3 m (10 ft) (see Figure 4E-2).

### *Option:*

Where there are constraints on a particular corner that make it impractical to provide the 3 m (10 ft) separation between the two pedestrian pushbuttons, the pushbuttons may be placed closer together or on the same pole.

### *Support:*

Figure 4E-3 shows typical pushbutton locations for a variety of situations.

### *Standard:*

**If two accessible pedestrian pushbuttons are placed on the same pole, the accessible 1 pedestrian pushbuttons shall be provided with the features described in Section 4E.09 for this situation.**

**Signs (see Section 2B.59) shall be mounted adjacent to or integral with pedestrian pushbuttons, explaining their purpose and use.**

### *Option:*

At certain locations, a supplemental sign in a more visible location may be used to call attention to the pedestrian pushbutton.

### *Standard:*

**The positioning of pedestrian pushbuttons and the legends on the pedestrian pushbutton signs shall clearly indicate which crosswalk signal is actuated by each pedestrian pushbutton.**

**If the pedestrian clearance time is sufficient only to cross from the curb or shoulder to a median of sufficient width for pedestrians to wait and the signals are pedestrian actuated, an additional pedestrian detector shall be provided in the median.**

### *Guidance:*

The use of additional pedestrian detectors on islands or medians where a pedestrian might become stranded should be considered.

If used, special purpose pushbuttons (to be operated only by authorized persons) should include a housing capable of being locked to prevent access by the general public and do not need an instructional sign.



*Standard:*

If used, a pilot light or other means of indication installed with a pedestrian pushbutton shall not be illuminated until actuation. Once it is actuated, the pilot light shall remain illuminated until the pedestrian's green or WALKING PERSON (symbolizing WALK) signal indication is displayed.

If a pilot light is used at an accessible pedestrian signal location, each actuation shall be accompanied by the speech message "wait."

*Option:*

At signalized locations with a demonstrated need and subject to equipment capabilities, pedestrians with special needs may be provided with additional crossing time by means of an extended pushbutton press.

*Standard:*

If additional crossing time is provided by means of an extended pushbutton press, a FOR MORE CROSSING TIME: HOLD BUTTON DOWN FOR 2 SECONDS (R10-32P) plaque (see Figure 2B-29) shall be mounted adjacent to or integral with the pedestrian pushbutton.

## SECTION 4E.09 ACCESSIBLE PEDESTRIAN SIGNAL DETECTORS

*Standard:*

An accessible pedestrian signal detector shall be defined as a device designated to assist the pedestrian who has visual or physical disabilities in activating the pedestrian phase.

*Option:*

Accessible pedestrian signal detectors may be pushbuttons or passive detection devices.

*Standard:*

At accessible pedestrian signal locations where pedestrian pushbuttons are used, each pushbutton shall activate both the walk interval and the accessible pedestrian signals.

An accessible pedestrian pushbutton shall incorporate a locator tone.

Pushbutton locator tones shall have a duration of 0.15 seconds or less and shall repeat at 1-second intervals.

**Pushbutton locator tones shall be intensity responsive to ambient sound, and be audible 1.8 to 3.7 m (6 to 12 ft) from the pushbutton, or to the building line, whichever is less. Pushbutton locator tones shall be no more than 5 dBA louder than ambient sound.**

**Pushbutton locator tones shall be deactivated when the traffic control signal is operating in a flashing mode.**

**To enable pedestrians who have visual disabilities to distinguish and locate the appropriate**

**pushbutton at an accessible pedestrian signal location, pushbuttons shall clearly indicate by means of tactile arrows which crosswalk signal is actuated by each pushbutton. Tactile arrows shall be located on the pushbutton, have high visual contrast (light on dark or dark on light), and shall be aligned parallel to the direction of travel on the associated crosswalk.**

### ***Guidance:***

Pushbuttons for accessible pedestrian signals should be located as close as possible to the crosswalk line furthest from the center of the intersection and as close as possible to the curb ramp.

Except as noted in the Option below, where two accessible pedestrian pushbuttons are provided, the pushbuttons should be separated by a distance of at least 3 m (10 ft) such that they clearly indicate which crosswalk has the WALKING PERSON (symbolizing WALK) indication.

### ***Option:***

Where there are constraints on a particular corner that make it impractical to provide the 3 m (10 ft) of separation between the two accessible pedestrian pushbuttons, the pushbuttons may be placed closer together or on the same pole.

### ***Standard:***

If two accessible pedestrian pushbuttons are placed on the same pole, each accessible pedestrian pushbutton shall be provided with the following features:

- A. A pushbutton locator tone,
- B. A tactile arrow,
- C. A speech walk message for the WALKING PERSON (symbolizing WALK) indication (see Section 4E.06), and
- D. A speech pushbutton information message.

If the pedestrian clearance time is sufficient only to cross from the curb or shoulder to a median of sufficient width for pedestrians to wait and accessible

pedestrian detectors are used, an additional accessible pedestrian detector shall be provided in the median.

### *Option:*

At locations with pretimed traffic control signals or nonactuated approaches, pedestrian pushbuttons may be used to activate the accessible pedestrian signals.

Additional features may be provided for pedestrians such as additional crossing time, audible beaconing, or a speech pushbutton information message as a result of an extended pushbutton press.

### *Standard:*

**If an extended pushbutton press is used to provide any additional feature(s), a pushbutton press of less than one second shall actuate only the pedestrian timing and any associated accessible walk interval, and a pushbutton press of one second or more shall actuate the pedestrian timing, any associated accessible walk interval, and any additional feature(s).**

**If additional crossing time is provided by means of an extended pushbutton press, a FOR MORE CROSSING TIME: HOLD BUTTON DOWN FOR 2 SECONDS (R10-32P) plaque (see Figure 2B-29) shall be mounted adjacent to or integral with the pedestrian pushbutton.**

### *Option:*

The name of the street to be crossed may also be provided in accessible format, such as Braille or raised print.

### *Support:*

Specifications regarding the use of Braille or raised print for traffic control devices can be found in the “Americans with Disabilities Act Accessibility Guidelines for Buildings and Facilities (ADAAG)” (see Section 1A.11).

### *Option:*

Tactile maps of crosswalks may be provided.

Speech pushbutton information messages may be made available by actuating the accessible pedestrian signal detector when the walk interval is not timing. These messages may provide intersection identification, as well as information about unusual intersection signalization and geometry, such as notification regarding

exclusive pedestrian phasing, leading pedestrian intervals, split phasing, diagonal crosswalks, and medians or islands.

### ***Standard:***

**If speech pushbutton information messages are made available by actuating the accessible**

**pedestrian signal detector, they shall only be actuated when the walk interval is not timing. They shall begin with the term “Wait,” followed by intersection identification information modeled after: “Wait to cross Broadway at Grand.” If information on intersection signalization or geometry is also given, it shall follow the intersection identification information.**

### ***Guidance:***

Speech pushbutton information messages should not be used to provide landmark information or to inform pedestrians with visual impairments about detours or temporary traffic control situations.

### ***Support:***

Additional information on structure and wording of pushbutton messages is included in ITE’s “Electronic Toolbox for Making Intersections More Accessible for Pedestrians Who Are Blind or Visually Impaired,” which is available at ITE’s website (see Page i).

# Excerpts from Draft Public Rights-of-Way Accessibility Guidelines (Draft PROWAG)

November 23, 2005

Updates are expected. Please check [www.access-board.gov](http://www.access-board.gov) for latest information.

## Sections on Accessible Pedestrian Signals

### CHAPTER R1: APPLICATION AND ADMINISTRATION

#### *R101 Purpose*

**R101.1 General.** This document contains scoping and technical requirements for accessibility to facilities for pedestrian circulation and use located in the public right-of-way. Advisory notes are for informational purposes only. These requirements are to be applied during the design, construction, additions to, and alterations of facilities in the public right-of-way to the extent required by regulations issued by Federal agencies.

*Advisory R101.1 General. Access requirements are also addressed in the Manual on Uniform Traffic Control Devices (MUTCD), FHWA/US DOT, 2003 (<http://mutcd.fhwa.dot.gov>). MUTCD is a reference standard in this guideline.*

*Key transportation industry guidance documents also address accessibility in the public right-of-way and can provide useful information on design and construction. They include 'Guide for the Planning, Design, and Operation of Pedestrian Facilities', American Association of State Highway and Transportation Officials, July 2004 ([www.aashto.org](http://www.aashto.org)) and 'Designing Sidewalks and Trails for Access', FHWA/US DOT September 2001 (<http://www.fhwa.dot.gov/environment/sidewalk2/index.htm>).*

**R101.2 Effect on Existing Facilities.** This document does not address existing facilities unless they are included in the scope of an alteration undertaken at the discretion of a covered entity. The U.S. Department of Justice and U.S. Department of Transportation have issued and enforce separate regulations for existing facilities subject to their requirements for program accessibility under the Americans with Disabilities Act.

*Advisory R101.2 Effect on Existing Facilities. The U.S. Department of Justice ADA regulations require that the usability of accessible features be maintained (28 CFR §35.133 and §36.211).*

*Federal agencies and entities receiving federal funds may also have an obligation for program accessibility under section 504 of the Rehabilitation Act of 1973 as amended. For example, state departments of transportation that receive Federal-aid Highway funds must comply with program accessibility requirements issued by the U.S. Department of Transportation at 49 CFR part 27.*

**R102 Equivalent Facilitation** Nothing in these requirements prevents the use of designs, products, or technologies as alternatives to those prescribed, provided they result in substantially equivalent or greater accessibility and usability.

**R103 Conventions R103.1 Dimensions.** Dimensions that are not stated as “maximum” or “minimum” are absolute.

**R103.1.1 Construction and Manufacturing Tolerances.** All dimensions are subject to conventional industry tolerances except where the requirement is stated as a range with specific minimum and maximum end points.

Advisory R103.1.1 Construction and Manufacturing Tolerances. Conventional industry tolerances recognized by this provision include those for field conditions and those that may be a necessary consequence of a particular manufacturing process. Recognized tolerances are not intended to apply to design work.

Information on specific tolerances may be available from industry or trade organizations, code groups and building officials, and published references.

**[Sections R103.2–R103.4 not included]**

## *R104 Referenced Guidelines and Standards*

**R104.1 General.** The guidelines and standards listed in R104.2 are incorporated by reference in this document and are part of the requirements to the prescribed extent of each such reference. The Director of the Federal Register has approved these guidelines and standards for incorporation by reference in accordance with 5 U.S.C. 552(a) and 1 CFR part 51. Copies of the referenced guidelines and standards may be inspected at the Architectural and Transportation Barriers Compliance Board, 1331 F Street, NW, Suite 1000, Washington, DC 20004; at the Department of Justice, Civil Rights Division, Disability Rights Section, 1425 New York Avenue, NW, Washington, DC; at the Department of Transportation, 400 Seventh Street, SW, Room 10424, Washington DC; or at the National Archives and Records Administration (NARA). For information on the availability of this material at NARA, call (202) 741-6030, or go to: [http://www.archives.gov/federal\\_register/code\\_of\\_federal\\_regulations/ibr\\_locations.html](http://www.archives.gov/federal_register/code_of_federal_regulations/ibr_locations.html).

R104.2 Referenced Guidelines and Standards. The specific edition of the guidelines and standards listed below are referenced in this document. Where differences occur between this document and the reference, this document applies.

R104.2.1 MUTCD. Manual on Uniform Traffic Control Devices for Streets and Highways (MUTCD), 2003 edition. Copies of the referenced standard may be obtained on-line from the Federal Highway Administration at <http://mutcd.fhwa.dot.gov>. (see R205 and R302.4).

**[Sections 104.2.2 – 104.2.3 not included]**

## *R105 Definitions*

**R105.1 General.** For the purpose of this document, the terms defined in R105.5 have the indicated meaning.

**R105.2 Terms Defined in Referenced Guidelines and Standards.** Terms not defined in R105.5 or in regulations issued by Federal agencies, but specifically defined in a referenced guideline or standard, shall have the specified meaning from the referenced guideline or standard unless otherwise stated.

**R105.3 Undefined Terms.** The meaning of terms not specifically defined in R105.5 or in regulations issued by Federal agencies or in referenced guidelines and standards shall be as defined by collegiate dictionaries in the sense that the context implies.

**R105.4 Interchangeability.** Words, terms and phrases used in the singular include the plural and those used in the plural include the singular.

### **R105.5 Defined Terms.**

**Accessible.** Describes a facility in the public right-of-way that complies with this part.

**Accessible Pedestrian Signal.** A device that communicates information about the WALK phase in audible and vibrotactile formats.

[Rest of Section 105.5 not included]

## **CHAPTER R2: SCOPING REQUIREMENTS**

### *R201 Application*

**R201.1 Scope.** All newly designed and newly constructed facilities located in the public right-of-way shall comply with these requirements. All altered portions of existing facilities located in the public right-of-way shall comply with these requirements to the maximum extent feasible.

*Advisory R201.1 Scope. This document (see R101.1General) covers facilities for pedestrian circulation and use in the right-of-way. Examples of facilities include, but are not limited to, walkways and sidewalks, street or highway shoulders where pedestrians are not prohibited, crosswalks, islands and medians, overpasses and underpasses, on-street parking spaces and loading zones, and equipment, signals, signs, street furniture, and other appurtenances provided for pedestrians. Examples of facilities not included are manholes and utility vaults.*

*These requirements are to be applied to all areas of a facility within the scope or limits of the planned project unless expressly exempted or limited with respect to the number of multiple elements required to be accessible. For example, not all benches are required to be accessible; those that are not required to be accessible are not required to comply with these requirements or to be served by a pedestrian access route.*

**R201.2 Temporary and Permanent Facilities.** These requirements shall apply to temporary and permanent facilities.

*Advisory R201.2 Temporary and Permanent Facilities. Temporary facilities covered by these requirements include, but are not limited to, temporary routes around work zones, portable toilets in the public right-of-way, sidewalk vending facilities, street fair booths, performance stages and reviewing stands, and the pedestrian access routes that serve them. As permitted in R203.1.1, structures and equipment directly associated with the actual processes of construction are not required to be accessible.*

[rest of 201.2 advisory and section 201.3 not included]

## **R202 Alterations and Additions to Existing Facilities**

**R202.1 General.** Additions and alterations to existing facilities shall comply with R202.

*Advisory R202.1 General. Alterations include, but are not limited to, renovation, rehabilitation, reconstruction, historic restoration, resurfacing of circulation paths or vehicular ways, or changes or rearrangement of structural parts or elements of a facility.*

[Rest of sections R202–R207 not included]

**R208 Accessible Pedestrian Signals (APS)** Where pedestrian signals are provided at pedestrian street crossings, they shall comply with R306.

[Sections R209– R222 not included]

## **CHAPTER R3: TECHNICAL PROVISIONS**

[Sections R301 – R305 not included]

### **R306 Accessible Pedestrian Signals (APS)**

**R306.1 General.** Pedestrian signals shall comply with R306.

**R306.2 Pedestrian Signals.** Each crosswalk with pedestrian signal indication shall have an accessible pedestrian signal which includes audible and vibrotactile indications of the WALK interval. Where a pedestrian pushbutton is provided, it shall be integrated into the accessible pedestrian signal and shall comply with R306.2.

*Advisory R306.2 Pedestrian Signals. Signals should generally sound and vibrate throughout the WALK interval. Where signals rest in WALK, audible operation may be limited to a repetition at short intervals rather than continuous sounding for several minutes.*

**R306.2.1 Location.** Accessible pedestrian signals shall be located so that the vibrotactile feature can be contacted from the level landing serving a curb ramp, if provided, or from a clear floor or ground space that is in line with the crosswalk line adjacent to the vehicle stop line.



**R306.2.1.1 Crossings.** Accessible pedestrian signal devices shall be 3.0 m (10.0 ft) minimum from other accessible pedestrian signals at a crossing. The control face of the accessible pedestrian signal shall be installed to face the intersection and be parallel to the direction of the crosswalk it serves.

**R306.2.1.2 Medians and Islands.** Accessible pedestrian signals located in medians and islands shall be 1.5 m (5.0 ft) minimum from other accessible pedestrian signals.

**R306.2.2 Reach and Clear Floor or Ground Space.** Accessible pedestrian pushbuttons shall be located within a reach range complying with R404. A clear floor or ground space complying with R402 shall be provided at the pushbutton and shall connect to or overlap the pedestrian access route.

**R306.2.3 Audible Walk Indication.** The audible indication of the WALK interval shall be by tone or speech message.

**R306.2.3.1 Tones.** Tones shall consist of multiple frequencies with a dominant component at 880 Hz. The duration of the tone shall be 0.15 s and shall repeat at intervals of 0.15 s.

*Advisory R306.2.3.1 Tones. Many new accessible pedestrian signal installations in the US use speech messages, which are perceived as being more user-friendly than tones. However, such messages may not be intelligible under high-ambient-noise conditions or to non-English speakers. Electronic tones are more universal and unambiguous. Section 4E.06 of the MUTCD specifies content of speech messages.*

**R306.2.3.2 Volume.** Tone or voice volume measured at 92 cm (3.0 ft) from the pedestrian signal device shall be 2 dB minimum and 5 dB maximum above ambient noise level in standard operation and shall be responsive to ambient noise level changes.

*Advisory R306.2.3.2 Volume. Where additional volume or beaconing features are available on pedestrian activation, they will momentarily exceed volume limits.*

**R306.3 Pedestrian Pushbuttons.** Pedestrian pushbuttons shall comply with R306.3.

**R306.3.1 Operation.** Pedestrian pushbuttons shall comply with R405.4.

**R306.3.2 Pushbutton Locator Tone.** Pedestrian pushbuttons shall incorporate a locator tone at the pushbutton. Pushbutton locator tone volume measured at 92 cm (3.0 ft) from the pushbutton shall be 2 dB minimum and 5 dB maximum above ambient noise level and shall be responsive to ambient noise level changes. The duration of the locator tone shall be 0.15 s maximum and shall repeat at intervals of one second. The locator tone shall operate during the DON'T WALK and flashing DON'T WALK intervals only and shall be deactivated when the pedestrian signal is not operative.

**R306.3.3 Size and Contrast.** Pedestrian pushbuttons shall be a minimum of 0.5 cm (2 in) across in one dimension and shall contrast visually with their housing or mounting.

**R306.3.4 Optional Features.** An extended button press shall be permitted to activate additional features. Buttons that provide additional features shall be marked with three braille dots forming an equilateral triangle in the center of the pushbutton.

**R306.4 Directional Information and Signs.** Pedestrian signal devices shall provide tactile and visual signs complying with 306.4 on the face of the device or its housing or mounting to indicate crosswalk direction and the name of the street containing the crosswalk served by the pedestrian signal.

**R306.4.1 Arrow.** Signs shall include a tactile arrow aligned parallel to the crosswalk direction. The arrow shall be raised 0.8 mm (.03 inch) minimum and shall be 4 mm (1.5 in) minimum in length. The arrowhead shall be open at 45 degrees to the shaft and shall be 33 percent of the length of the shaft. Stroke width shall be 10 percent minimum and 15 percent maximum of arrow length. The arrow shall contrast with the background.

**R306.4.2 Street Name.** Accessible pedestrian signals (APS) shall include street name information aligned parallel to the crosswalk direction and shall comply with R409.3 or shall provide street name information in audible format.

**R306.4.3 Crosswalk Configuration.** Where provided, graphic indication of crosswalk configuration shall be tactile.

[Sections R307–R309 not included]

**Sections referenced in R306.2.2 Reach and Clear Floor or Ground Space:**

### *R402 Clear Space*

**R402.1 General.** Clear space at accessible pedestrian signals (APS), street furniture, and operable parts shall comply with R402.

**R402.2 Surface Characteristics.** Surfaces of clear spaces shall comply with R301.5 and shall have a slope and cross slope of 2 percent maximum.

**R402.3 Size.** The clear space shall be 760 mm (30 in) minimum by 1220 mm (48 in) minimum.

**R402.4 Knee and Toe Clearance.** Unless otherwise specified, clear space shall be permitted to include knee and toe clearance complying with R403.

**R402.5. Position.** Unless otherwise specified, clear space shall be positioned for either forward or parallel approach to an element.

**R402.6 Approach.** One full unobstructed side of the clear space shall adjoin a pedestrian access route or adjoin another clear space.

**R402.7 Maneuvering Space.** Where a clear space is located in an alcove or otherwise confined on all or part of three sides, additional maneuvering space shall be provided in accordance with R402.7.1 and R402.7.2.

**R402.7.1 Forward Approach.** Alcoves shall be 915 mm (36 in) wide minimum where the depth exceeds 610 mm (24 in).

**R402.7.2 Parallel Approach.** Alcoves shall be 1525 mm (60 in) wide minimum where the depth exceeds 380 mm (15 in).

## ***R404 Reach Ranges***

**R404.1 General.** Reach ranges shall comply with R404.

### **R404.2 Forward Reach.**

**R404.2.1 Unobstructed.** Where a forward reach is unobstructed, the high forward reach shall be 1220 mm (48 in) maximum and the low forward reach shall be 380 mm (15 in) minimum above the finish surface.

**R404.2.2 Obstructed High Reach.** Where a high forward reach is over an obstruction, the clear space shall extend beneath the element for a distance not less than the required reach depth over the obstruction. The high forward reach shall be 1220 mm (48 in) maximum where the reach depth is 510 mm (20 in) maximum. Where the reach depth exceeds 510 mm (20 in), the high forward reach shall be 1120 mm (44 in) maximum and the reach depth shall be 635 mm (25 in) maximum.

### **R404.3 Side Reach.**

**R404.3.1 Unobstructed.** Where a clear space allows a parallel approach to an element and the side reach is unobstructed, the high side reach shall be 1220 mm (48 in) maximum and the low side reach shall be 380 mm (15 in) minimum above the finish surface. An obstruction shall be permitted between the clear space and the element where the depth of the obstruction is 255 mm (10 in) maximum.

**R404.3.2 Obstructed High Reach.** Where a clear space allows a parallel approach to an element and the high side reach is over an obstruction, the height of the obstruction shall be 865 mm (34 in) maximum and the depth of the obstruction shall be 610 mm (24 in) maximum. The high side reach shall be 1220 mm (48 in) maximum for a reach depth of 255 mm (10 in) maximum. Where the reach depth exceeds 266 mm (10 in), the high side reach shall be 1170 mm (46 in) maximum for a reach depth of 610 mm (24 in) maximum.

### **Section referenced in R306.3.1 Pedestrian Pushbuttons, Operation:**

**R405.4 Operation.** Operable parts shall be operable with one hand and shall not require tight grasping, pinching, or twisting of the wrist. The force required to activate operable parts shall be 22 N (5 lbs) maximum.

### **Section referenced in R306.4.2 Street Name**

**R409.3 Braille.** Braille shall be contracted (Grade 2) and shall comply with R409.3 and R409.4.

**R409.3.1 Dimensions and Capitalization.** Braille dots shall have a domed or rounded shape and shall comply with Table R409.3.1. The indication of an uppercase letter or letters shall only be used before the first word of sentences, proper nouns and names, individual letters of the alphabet, initials, and acronyms.

**R409.3.1 Braille Dimensions**

MEASUREMENT RANGE	MINIMUM IN MILLIMETERS
	MAXIMUM IN MILLIMETERS
Dot base diameter	1.5 mm (0.059 in) to 1.6 mm (0.063 in)
Distance between two dots in the same cell*	2.3 mm (0.090 in) to 2.5 mm (0.100 in)
Distance between corresponding dots in adjacent cells*	6.1 mm (0.241 in) to 7.6 mm (0.300 in)
Dot height	0.6 mm (0.025 in) to 0.9 mm (0.037 in)
Distance between corresponding dots from one cell directly below*	10 mm (0.395 in) 10.2 mm to (0.400 in)

\* Measured center to center

**R409.3.2 Position.** Braille shall be positioned below the corresponding text. If text is multi-lined, braille shall be placed below the entire text. Braille shall be separated 9.5 mm (.375 in) minimum from any other tactile characters and 9.5 mm (.375 in) minimum from raised borders and decorative elements. Braille provided on elevator car controls shall be separated 4.8 mm (.1875 in) minimum and shall be located either directly below or adjacent to the corresponding raised characters or symbols.

**R409.4 Installation Height and Location.**

Signs with tactile characters shall comply with R409.4.

**R409.4.1 Height Above Finish Floor or Ground.** Tactile characters on signs shall be located 1.2 m (4.0 ft) minimum above the finish floor or ground surface, measured from the baseline of the lowest tactile character and 1.5 m (5.0 ft) maximum above the finish floor or ground surface, measured from the baseline of the highest tactile character. Tactile characters for elevator car controls shall not be required to comply with R409.4.1.



# Appendix B:

## Product Information

Campbell Company .....	B-248
Novax Industries .....	B-251
Bob Panich Consultancy .....	B-254
Polara Engineering .....	B-256
Prisma Teknik .....	B-258

## Introduction

Information on Accessible Pedestrian Signal (APS) manufacturers was obtained directly from manufacturers and manufacturers' web sites in May 2007 and updated in 2009. Be sure to confirm features, functioning, and installation requirements of APS with the manufacturer before purchase, as APS product offerings are constantly changing. New manufacturers may enter the U.S. market at any time; this appendix lists ones that authors of this Guide are aware of at the time of publication. There are a number of companies manufacturing and distributing APS in other countries and more development can be expected.

The descriptions of features of APS, as well as how these features are used by pedestrians who are blind and visually impaired can be found in Chapter 4. If the manufacturer uses a term different from the terms commonly used in this document for a feature, the manufacturer's term is listed in parentheses.

In the descriptions of each product, "standard features" refer to features that are included in the standard price or on all models. "Optional features" refer to features that must be ordered extra or need special specifications on ordering (i.e., speech messages or pushbutton information messages that may need to be recorded by the manufacturer).

## Campbell Company

450 W. McGregor Dr.  
Boise, ID 83705  
Phone: 208-345-7459  
Fax: 208-345-7481  
<http://www.pedsafety.com>

### MODELS

- AAPS—Advanced Accessible Pedestrian System
- Advisor—Fully Integrated Pedestrian Station
- Advisor—Base Broadcast Unit
- VTO—Vibrotactile only

### STANDARD FEATURES

#### *Advanced Accessible Pedestrian System*

##### Walk Indications

- Speech Messages and Tones
- Vibrotactile Arrow

##### Other

- Speaker at Pushbutton
- Pushbutton locator tone
- Tactile arrow
- Automatic volume adjustment
- Separate volume controls for locator and speech messages
- Actuation indicator: tone, message, LED
- Rest in Walk
- Extended pushbutton functions
- Synchronization of all stations for specific pedestrian movements
- Custom speech messages
- Time of day functions
- RJ45 TS2 interface

#### *Advisor—Fully Integrated Pedestrian Station*

##### Walk Indications

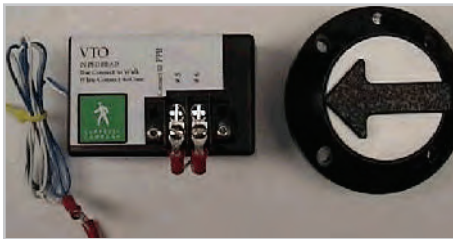
- Speech Messages and Tones
- Vibrotactile Arrow



**Figure B-1. Advisor FIPS 57**



**Figure B-2. Advisor FIPS H**



**Figure B-3. VTO Unit**



**Figure B-4. BBU, showing speaker mounted on bottom of pedestrian signal head**

## Other

- Speaker at Pushbutton
- Pushbutton locator tone
- Tactile arrow
- Automatic volume adjustment
- Separate volume controls for locator and speech messages
- Actuation indicator: tone, message, LED
- Synchronization of initiation and destination for target beaconing
- Custom speech messages
- Rest in Walk
- Extended pushbutton functions
- Fault indicator



### *Advisor — Base Broadcast Unit*

#### **Walk Indications**

- Speech Messages and Tones

### *VTO — Vibrotactile only*

#### **Walk Indications**

- Vibrotactile signal at push button — no audible.

## **OPTIONAL FEATURES**

- Braille
- Crosswalk tactile map
- Bluetooth capable

## **INSTALLATION NOTES**

### *Advanced Accessible Pedestrian System*

- Utilizes existing 2 wires from Traffic Control cabinet
- Pre-programmed with adjustments and modifications made from laptop

### *Advisor — Fully Integrated Pedestrian Station*

- Utilizes existing 2 wires from Traffic Control cabinet
- Ethernet cable from pedestrian station to driver in ped head
- No special tools required for installation

## **COMMENTS**

BBU is designed for intersection with no pedestrian actuation. The Walk Cycle signal is broadcast down from the ped head to the crossing initiation point.

Advisor FIPS provides both audible and vibrotactile indications and other features, as required in Draft PROWAG.

VTO units provide vibrotactile indications only.

## Novax Industries

658 Derwent Way

New Westminster, BC, Canada V3M 5P8

Phone: 866-977-4APS (1-866-977-4277)

Phone: 604-525-5644

Fax: 604-525-2739

<http://www.novax.com>

### MODELS

- DS100
- DS3000

Additional components for DS3000: Vibrawalk, with functions of pushbutton and vibrating arrow integrated

### STANDARD FEATURES

#### *DS100*

##### **WALK indication**

- Two or four tones standard, cuckoo and chirp (peep-peep) and two additional custom tones

##### **Other**

- Speaker unit mounts on pedestrian signal head

#### *DS3000*

##### **WALK indication**

- Two or four tones standard, Cuckoo, chirp, short beep, and long beep
- Dip switch setting to provide either concurrent sound from both ends of the crosswalk or sound which alternates from each end of the crosswalk
- Optional additional unit (VibraWalk) to provide vibrotactile indication

##### **Other**

- Typically mounted on pedestrian signal head
- Automatic volume adjustment (dynamic proportional volume compensation)
- Separate volume settings for locator tone and WALK signal
- External sound adjustment screws
- Separate circuit to drive the optional vibrating tactile feature

## OPTIONAL FEATURES

- VibraWalk2 unit which provides pushbutton locator tone, actuation indicator (Button Lamp Indicator, BLI), Pushbutton information message (Pedestrian Acknowledge), and vibrotactile arrow at pushbutton
- Custom Speech messages for DS100 (up to 15 seconds) and DS3000 (up to 32 seconds)
- Sound inhibit interacts with traffic signal controller to disable audible indications as required
- Maximum walk timer for “Rest-In-WALK” intersections
- DS3000i option provides a control board which is mounted inside the pedestrian signal head, to drive VibraWalk2 unit and provide all sounds from pushbutton, or for use with optional additional beaconing speaker

## INSTALLATION NOTES

4 wire 20 gauge

120 VAC derived from WALK and DONT WALK indicator

## COMMENTS

Optional VibraWalk unit is needed to provide pushbutton locator tone, tactile arrow and vibrotactile WALK indications, as required by Draft PROWAG.



**Figure B-6. The DS100 mounted on pedestrian signal heads**



**Figure B-7. The Vibrawalk2 unit for use with the DS3000 to provide a pushbutton locator tone and a vibrotactile arrow.**



**Figure B-8. DS3000 is the company's newest product**

## Bob Panich Consultancy

PO Box 360  
Ryde NSW 1680  
Australia  
Phone: 61 2 9809 6499  
Fax: 61 2 9809 6962  
<http://www.bobpanich.com.au/>

### MODELS

- BPC

### STANDARD FEATURES

#### *WALK indication*

- Tone—500 Hz with a repetition rate of 8.5 Hz—series of rapid thump sounds
- Vibrating arrow

#### *Other*

- Pushbutton locator tone (locating tone)—880 Hz with a repetition rate of 1 Hz for US market or 1000 Hz with a repetition rate of 0.55 Hz for Australian market
- Tactile arrow
- Automatic volume adjustment, with three standard settings for response
- Alert tone (transitional tone)—brief burst of 3500 Hz tone, decreasing exponentially to 700 Hz, and then going to 500 Hz WALK tone

### OPTIONAL FEATURES

- Cuckoo and chirp or other sounds
- Fixed WALK message length of 8, 16 or 32 seconds or WALK message can be on during the full WALK interval
- Actuation indicator (demand indicator/demand tone) —light and tone
- Long button press — allows pedestrians to request a WALK tone at 12 dB above the sound of the locator tone (Higher volume demand, HVD)

### INSTALLATION NOTES

Driver unit is mounted in a housing on the pole near the pedhead, wired to the pedhead.

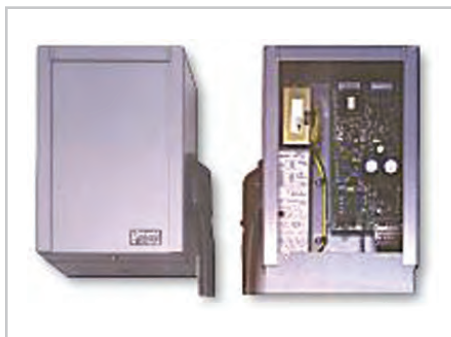
Automatic gain control level is set during installation.

## COMMENTS

Complies with specifications of the Australian standard; standard pushbutton in Australia.



**Figure B-9. Panich BPC**



**Figure B-10. Driver unit for Panich BPC**

## Polara Engineering

9153 Stellar Court  
Corona, CA 92883  
Phone: 888-340-4872  
Phone: 714-521-0900  
Fax: 714-521-5587  
www.polara.com

### MODELS

- Navigator

### STANDARD FEATURES

#### *WALK indication*

- Rapid tick
- Speech message or cuckoo/chirp
- Vibrating tactile arrow

#### *Other*

- Speaker at pushbutton
- Pushbutton locator tone (locating tone)
- Tactile arrow
- Automatic volume adjustment—60 dB range
- Separate minimum & maximum volume settings for Pushbutton locator tone (Locate sound), Clearance & WALK Sounds.
- Actuation indicator—tone, LED light and tactile bounce back
- Depression in the arrow enables pushbutton operation with a head stick
- Push button failures or system failures default to transmitting a constant pedestrian call

### OPTIONAL FEATURES

- Custom speech messages
- Fixed WALK message timing or WALK message can be on during full WALK interval
- Braille street name on the face plate
- Face plate with informational sign
- Optional clearance sounds or audible countdown of remaining seconds during clearance available

- Direction of travel message
- Extended pushbutton functions:
  - o Pushbutton Information message (pushbutton message)
  - o Audible beaoning—volume increase of WALK indication and pushbutton locator tone during the subsequent pedestrian phase
  - o Extended push priority (mutes entire intersection except selected crosswalk to minimize confusion caused by other sounds)



**Figure B-11. Polara Navigator APS mounted on pole**

## INSTALLATION NOTES

### *2-wire system*

Operates with only two wires from the intersection traffic control cabinet to the pushbutton and is programmable after installation by the installer using a handheld PDA type device. Control unit is mounted in the signal controller. Numerous options programmable with PDA.

### *4-wire system*

Used when pushbutton wires from the traffic control cabinet to each button location do not exist. Two pair of 18-22 gauge wires run from the control unit that mounts in the pedestrian signal head to the pushbutton unit. All features programmed after installation by the installer using a handheld PDA type device.

A PDA-type device called a Configurator is an additional piece of equipment that is needed for setting the features and volume of their 2-wire and 4-wire APS. Jurisdictions will need to purchase one or two for technician use.



## Prisma Teknik

Box 5 Mariestadsvägen 28  
543 21 TIBRO, Sweden  
Tel: +46 (0)504 400 40  
Fax: +46 (0)504 141 41  
<http://www.primateknik.se>

### MODELS

- TS-903F, TS-904F, TS-907F, TS-908F very similar with slightly different features
- Digital Acoustic Pedestrian Signal, DAPS

### STANDARD FEATURES

*TS-903F, TS-904F, TS-907F, TS-908F*

#### WALK indication

- Rapidly repeating percussive tone
- Vibrating arrow on TS-907 and TS-908 only

#### Other

- Speaker at pushbutton
- Pushbutton locator tone
- Tactile arrow
- Automatic volume adjustment within range of 55–95 dB
- Actuation indicator—light and tone—on TS-903 and TS-907 only
- Crosswalk tactile map (Braille map)
- Fault indicator

### OPTIONAL FEATURES

- 10 different tones available
- Night switch to deaden sound
- Double-ended arrow available for use on medians and right-angle arrow available for use with exclusive pedestrian phasing, where there is a single pushbutton on a corner

## DAPS

### WALK indication

- Rapidly repeating percussive tone
- Vibrating arrow

### Other

- Speaker at pushbutton
- Pushbutton locator tone
- Tactile arrow
- Automatic volume adjustment within range of 55–95 dB
- Actuation indicator—light and tone
- Crosswalk tactile map (Braille map)
- Fault indicator

## OPTIONAL FEATURES

- 10 different tones available by setting with PDA
- Custom speech WALK messages, recorded and programmable with PDA
- Additional beaming speaker (TS-995) for mounting at overhead location
- Night switch to deaden sound
- Double-ended arrow available for use on medians and right-angle arrow available for use with exclusive pedestrian phasing, where there is a single pushbutton on a corner
- Extended button press features
  - o Pushbutton information message 1–16 seconds

## INSTALLATION NOTES

Numerous features of DAPS model are programmable with PDA.

Volume min/max levels are adjustable by installer.

Step-down transformer available for mounting in the pedestrian signal head for U.S. installation

Tactile arrow is mounted horizontally on top of device, allowing some latitude in placement of APS on pole, while still making it possible to align the arrow parallel with the associated crosswalk.

Wiring colors may conform to European standards rather than U.S. standards



Figure B-12. Prisma TS-907F

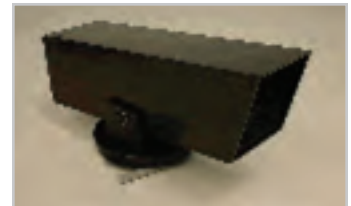


Figure B-13. Prisma TS-995 pedhead-mounted beaming loud speaker



# Appendix C: Research on APS

## Introduction

Throughout the preceding chapters of this Guide, references were made to various studies to support the recommendations given in those chapters. Interested readers may wish to see more details on the studies underlying these recommendations. This appendix was designed for such readers. This appendix reviews the research literature on APS including:

- Research on problems of blind pedestrians
- Effects of APS on particular street crossing tasks
- Effects of APS on independence and confidence
- Effects of WALK signal characteristics
- Accuracy and speed in identifying WALK indication for a given crossing
- Research on source of the WALK signal
- Research on other APS features
- Other concerns and needs
- Need for additional research

# Research on problems of blind pedestrians

## INTRODUCTION

Although APS have been widely used in Japan and Sweden since the 1960s, the early development of APS in those countries was not, as far as these authors have been able to ascertain, based on research. Nor was there any research basis for the “cuckoo/cheep” APS that has been most commonly used in the U.S.

The first substantial research on APS appears to have been done in 1976 by Frank Hulscher, an electrical engineer with the Department of Motor Transport, New South Wales, Australia. Hulscher’s research was the basis for the well developed, fully standardized, and highly successful APS system in use in Australia today.

Substantial research on APS in the U.S. began with a project undertaken by the San Diego Association of Governments in 1988. The results of this project were the basis for a policy of implementing standard signals at intersections in San Diego where a city access committee recommended them, following a systematic evaluation.

Since 1996, there has been a concerted research effort related to APS. Several research studies and surveys have documented problems of pedestrians who are blind or who have low vision at signalized intersections without APS. (Barlow, Bentzen, and Bond, 2005; Bentzen, Barlow and Bond, 2004; Bentzen, B.L., Barlow, J.M. & Franck, L. 2000; Carroll, J. & Bentzen, B.L. 1999; Murakami, Ishikawa, Ohkura, Sawai, Takato and Tauchi, 1998, San Diego Association of Governments, 1988). Several studies in the U.S. have compared travel by blind pedestrians with and without APS. (Barlow, Bentzen, Bond and Gubbe, 2006; Crandall, Bentzen and Myers, 1998; Crandall, Brabyn, Bentzen and Myers, 1999; Crandall, Bentzen, Myers and Brabyn, 2001; Marston and Golledge, 2000; Uslan, Peck and Waddell, 1988; Williams, Van Houten, Ferraro, and Blasch, 2005). In these studies, some of the APS have been signals mounted on the pedestrian signal head, while others have been receiver-based systems, and others been pushbutton-integrated devices. Information in this section is drawn from these studies. A brief summary of each follows.

### *Surveys of blind pedestrians and orientation and mobility specialists*

San Diego Association of Governments (1988; and Szato, Valerio, and Novak, 1991a, b, c, hereafter referred to collectively as San Diego research) surveyed 71 national, regional and local organizations representing and/or serving elderly persons and persons who were visually impaired to determine their involvement in installation of audible signals and the level of support for audible signals; 36 responses were received. A separate survey was also sent to members of California Association of Orientation and Mobility Specialists to gather information about their experience with audible signals. Surveys were mailed to 67 members and 27 responses were received.

In 1998, the American Council of the Blind (ACB) and the Association for Education and Rehabilitation of the Blind and Visually Impaired (AER) conducted similar surveys to determine problems experienced by blind pedestrians during street crossings. Problems with audible signals currently installed were also identified by the surveys.

- ACB survey (Carroll, J. & Bentzen, B.L. 1999, hereafter referred to as ACB survey)—surveys administered orally, in groups, to 158 pedestrians who are visually impaired
- AER survey (Bentzen, B.L., Barlow, J.M. & Franck, L. 2000, hereafter referred to as AER survey)—mailed to 1000 orientation and mobility specialists. 349 surveys returned.

Murakami, Ishikawa, Ohkura, Sawai, Takato and Tauchi (1998) conducted a survey of 50 blind pedestrians in Japan.

More details about the survey results, and references to studies which support the results, are provided in the section on crossing problems.

### *Crossing data*

Uslan, Peck and Waddell (1988) compared crossings by 27 legally blind pedestrians at three intersections in Huntington Beach, California, having “bird call” signals and one control intersection without APS.

In research by The Smith-Kettlewell Eye Research Institute (Crandall, Bentzen and Myers, 1998, Crandall, Bentzen, Myers and Brabyn, 2001, Crandall, Brabyn, Bentzen and Myers, 1999, hereafter referred to collectively as SKERI research), 20 blind participants made a total of 80 crossings at 4 fixed-time signalized intersections in downtown San Francisco, both with and without Talking Signs®. Talking Signs is a receiver-based APS. Intersection signal phases were pretimed and pushbutton use was not required. There were nine measures, including measures of crossing timing (safety), orientation (precision), and independence.

Marston and Golledge (2000) compared crossings by blind participants with and without APS, using the receiver-based APS system, Talking Signs, in a study investigating the use of Talking Signs remote infrared audible signs for a number of transit tasks.

The effects of a pushbutton-integrated APS, a receiver-based APS manufactured by Relume, and typical visual pedestrian signals without APS on the street crossing behavior of 24 totally blind participants were compared by Williams, Van Houten, Ferraro, and Blasch (2005).

As part of a project on blind pedestrians at complex intersections, funded by the National Eye Institute, National Institutes of Health, a series of studies on crossings by blind pedestrians with and without APS is in progress in four cities, Portland, Oregon, Charlotte, Tucson, and Cambridge, Massachusetts. Objective data on measures of street crossing performance by sixteen participants who were blind was

obtained at two complex, signalized intersections in each city. Measures were similar to those used in the SKERI research, including nine broad measures of crossing timing, orientation, and independence. Results from all four cities are not yet analyzed, but slightly different analyses have been reported in several articles. Results from pre-installation testing in two cities, Portland and Charlotte, are reported in Bentzen, Barlow and Bond (2004, hereafter referred to as NEI-2 cities) and Barlow, Bentzen, and Bond (2005, hereafter referred to as NEI-3 cities) reports on three cities, Portland, Charlotte and Cambridge. Barlow, Bentzen, Bond and Gubbe (2006, hereafter referred to as NEI Portland pre-post) compare results of testing with and without APS in one of these cities, Portland, Oregon.

## **PROBLEMS WITH SPECIFIC TASKS AT SIGNALIZED INTERSECTIONS BY PEDESTRIANS WHO ARE BLIND OR WHO HAVE LOW VISION**

### *Locating the crosswalk*

Pedestrians who are visually impaired use a variety of non-visual cues and strategies to locate crosswalks, none of which is absolutely reliable. Cues include proximity to the corner or to traffic on the street parallel to the pedestrian's direction of travel, location of curb ramps when present, location of idling cars on the street to be crossed, and presence of other pedestrians. When APS are present, they may also be used as an indication of the location of crosswalks.

ACB and AER surveys did not include specific questions about locating the crosswalk. 78% of individuals in the Japanese survey indicated that locating the crosswalk was difficult at intersections without APS.

In SKERI research, without APS, participants requested assistance in locating the crosswalk on 19% of street crossings. Participants were permitted to begin a crossing from any location that satisfied them, whether or not it was actually within the crosswalk lines. On 30% of trials, subjects who located the crosswalk independently began crossing from outside the crosswalk. (Participants were permitted to start crossing from any location so long as they were in no immediate danger.)

The NEI-3 cities results indicated that participants started from outside the crosswalk area on 28.3% of crossings and requested or required assistance locating the crosswalk on 15% of crossings.

### *Orientation (Aligning to cross and maintaining alignment while crossing)*

Pedestrians who are visually impaired typically use a number of clues to help them align to face the direction of travel on the crosswalk before beginning to cross. These include vehicular sounds such as the direction of parallel traffic flow and the location of idling traffic on the street to be crossed. Another good cue, or strong predictor,

of the direction of the destination corner is the direction pedestrians are traveling before they arrive at the starting corner. Additional cues that are useful in familiar locations are walls, fences, hedges, grasslines, and objects near the curb that have a straight surface that is either parallel or perpendicular to the direction of travel across the crosswalk. The direction of slope of the curb ramp, and the alignment of a truncated dome detectable warning near the bottom of the curb ramp are not reliable indicators of the direction of travel on the crosswalk, and when used either intentionally or inadvertently, may lead pedestrians who are visually impaired into the center of an intersection. Although there are numerous clues to the direction of travel on the crosswalk, none of them alone or in combination provide a definitive direction to pedestrians who are crossing at unfamiliar crosswalks.

Two clues used to help pedestrians who are blind maintain their alignment while crossing are the distance and direction of parallel traffic flow, and the location of idling vehicles on the perpendicular street. Even at familiar crossings these clues may not be sufficient to provide positive guidance to pedestrians who are blind as they are crossing a street.

In the AER survey, 97% of O&M specialists who responded indicated that their students had difficulty aligning to cross the street while 66% indicated that their students sometimes had difficulty knowing where the destination corner was. The most important reasons stated were that traffic was intermittent or the intersection was offset. In the ACB survey, 79% of respondents indicated that they sometimes have difficulty figuring out where the destination corner is.

Respondents to the Japanese survey indicated that “direction taking at the starting position” and “keeping direction while walking in the crosswalk” were a problem, even with APS.

The broadcast sound from speakers mounted on the pedestrian signal head has not seemed to provide usable directional information. ACB and AER surveys indicated that pedestrians who are blind are sometimes not able to localize the sound of an APS in order to use it for guidance across the street. ACB – 6%; AER – 39%. 85% of ACB respondents indicated that they were sometimes confused by unexpected features such as medians or islands while 64% of O&M respondents indicated that their students had difficulty with medians or islands.

In SKERI research, participants started crossing from an aligned position on 48% of crossings without use of APS, and completed their crossings within the crosswalk on 58% of crossings. In the NEI-3 cities research (without APS), participants started from an aligned position on 73.4% of crossings. Participants requested assistance or required intervention for safety while aligning to cross on 10% of crossings. Of participants who aligned independently, 58.4% completed their crossings within the crosswalk.

### *Using pushbuttons*

At 90–95% of signalized intersections today, signal timing is constantly adjusting to accommodate current vehicular and pedestrian traffic, and pedestrians are required to push a button to actuate a pedestrian timing to cross the street. Unless a pedestrian



pushes the button, the WALK signal will not come on, and, when there is a green signal for parallel traffic, it is timed to accommodate vehicular traffic, not pedestrians. A pedestrian who does not push the button, and who crosses with the green signal for parallel traffic, may not have enough time to cross the street. The vehicular signal timing may be as much as 20 seconds less than the pedestrian signal timing (Barlow and Franck, 2005). Therefore it is very important that pedestrians who are visually impaired use pushbuttons.

Blind pedestrians experience a number of problems with pushbuttons.

In the ACB and AER surveys, many respondents indicated that they or their students had difficulty with pushbuttons: ACB – 90%; AER – 94%. The following reasons were given.

- Users couldn't tell whether they needed to push a button.
- Users had difficulty locating the button.
- Users couldn't tell which crosswalk was actuated by the button.
- The pushbutton was so far from the crosswalk that users couldn't push the button and then return to the crosswalk and align to cross before the WALK interval began.

Uslan et al, (1998) also found that the major problems 27 legally blind participants had with “bird call” type APS, were in locating the pole and the pushbutton, and determining which pushbutton was for which crosswalk. Participants traveling with dog guides experienced the most difficulty locating the pole. Sometimes participants first located the incorrect button and subsequently located and pushed the correct button after waiting and listening through one or more cycles.

The San Diego research also identified problem with locating the pushbuttons and poles (Szeto et al. 1991a). Gallagher and Montes de Oca (1998) also noted this in research on vibrotactile-only APS.

In the NEI-2 cities results, at crossings where pushbutton-actuation was required, participants looked for, found, and pushed the button on only 16.3% of these crossings in Portland, and none (0%) of the crossings in Charlotte.

In research under NCHRP 3-62 (see NCHRP 3-62 Final Report, , and Bentzen, Scott and Barlow, in press), blind participants crossing at signalized intersections in Tucson, having APS, but without any instruction in use or purpose of the APS, failed to even search for pushbuttons on 29% of crossings.

### *Identifying the onset of the WALK interval*

In the absence of an APS, pedestrians who are visually impaired rely on the stopping of perpendicular traffic followed by the onset of parallel traffic, to indicate the onset of the WALK interval. Pedestrians who do not quickly and accurately identify the onset of the WALK interval are likely to be delayed in starting to cross, may miss crossing on the first pedestrian phase, or may begin crossing when the WALK

interval is not in effect. Complex geometry and intersection signalization make the use of traditional clues to the onset of the WALK interval unreliable.

Many respondents to the surveys indicated that they or their students sometimes had difficulty knowing when to begin crossing: ACB – 91%; AER – 98%. The following reasons were identified.

- The surge of traffic was masked by right turning traffic.
- Traffic flow was intermittent.
- The intersection was too noisy.
- The surge of traffic was too far away.

In the AER survey, 79% of respondents indicated that blind students sometimes had difficulty determining the onset of the WALK interval at intersections having exclusive pedestrian phasing.

In the Japanese survey, 46% of respondents stated that “to take a timing to start” was difficult without APS.

Uslan found that, at the control intersection without APS, which was considered the easiest to cross without APS, 4 out of 15 participants began crossing during DONT WALK.

In SKERI research on 24% of trials when APS information was not available, blind pedestrians requested assistance in knowing when to start crossing. On 34% of trials on which they independently initiated crossings, participants began crossing during the flashing or steady DONT WALK.

The NEI-3 cities research found that pedestrians who were blind independently began crossing during the WALK interval on only 48.6% of crossings and completed crossings after the onset of perpendicular traffic on 26.9% of crossings. The need for pushbutton-actuation of the WALK interval affected the likelihood that participants would begin crossing during the WALK interval. On the pedestrian-actuated crossings, participants began crossing during the WALK interval on only 19.5% of the crossings compared to 71.7% of crossings where the pedestrian phase was on recall (the pedestrian phase was included in every cycle).

Mean latency in beginning crossing (the time between onset of the WALK signal or near-side parallel traffic and the participant beginning to cross) was 6.41 seconds.

### ***Problems with APS***

The ACB and AER surveys were not limited to information about crossings that did not have APS; they had questions about APS volume, and about confusion of tones.

### **Volume**

The 1998 ACB and AER surveys reported the experience of pedestrians with visual impairments in using APS that had “bird call” signals, bells and buzzers. There

were problems both with APS being considered too quiet and too loud. 45% of participants in ACB survey considered signals to be too loud while 71% considered them too quiet. 24% of AER participants considered signals to be too loud, while 52% reported that APS were too quiet.

When APS are too loud, and are at intersections that are close together, the APS for one intersection may be heard from another, leading some pedestrians to incorrectly think they have the WALK interval. The surveys noted this problem: ACB – 19%; AER 25%.

In addition, complex phasing can contribute to problems with APS volume. Uslan et al. (1988) found that, at one intersection with split phase timing, where the bird call signals for parallel crosswalks had separate timing, three of 15 blind participants initiated their crossings with the signal for the parallel crosswalk, walking into the paths of left-turning vehicles.

### **Problems with APS—knowing which street has the WALK signal**

Researchers particularly evaluated data on the AER and ACB surveys from blind pedestrians and O&M specialists from California, whose experience with APS is almost exclusively with “bird call” signals that are intended to provide unambiguous information regarding which street has the WALK interval. Many respondents indicated that they or their students sometimes did not know which crosswalk had the WALK interval (ACB – 68%; AER – 72%). Reasons were the following.

- Users forgot which signal was associated with which crossing direction;
- Users didn’t know which direction they were traveling; and
- The intersection was not aligned with primary compass directions.

The San Diego research also indicated that blind pedestrians had difficulty remembering which sound was for which crossing direction.

Recent research in the NEI project and under NCHRP 3-62 addressed this issue. (See Chapter 3.)

### **Problems with APS—Confusion of tones with other sounds**

Anecdotal evidence has existed for some time that some birds in the U.S. have calls that are like the cheep sound of some APS, and that other birds may mimic this sound. This has led to confusion between APS sounds, particularly the cheep sound, and the sounds of birds.

AER and ACB surveys confirmed that blind pedestrians really do confuse the sounds of birds with APS sounds. In the AER survey, 11% of respondents stated that their students had crossed the street with an actual bird and 10% stated that their students had not crossed because they thought the signal was a bird. Uslan et al. (1988) and the San Diego research also noted this as a problem.

## *Pedestrian crashes*

To obtain a rough measure of the incidence of intersection crashes and near crashes for pedestrians who are visually impaired, the ACB survey asked respondents whether they had been struck by a car at an intersection, and whether they had had their long canes run over. In the ACB survey, 12 of 158 (8%) of respondents had been struck by a car at an intersection, and 45 (28%) had had their long canes run over.

# Effects of APS on specific crossing tasks

## INTRODUCTION

Since it is known that pedestrians with visual impairments have difficulty with many of the tasks that, taken together, comprise street crossing, it would be desirable to think that APS improve all measures of crossing at signalized intersections. To determine the extent to which this is true, a number of research projects have obtained objective data comparing street crossing with and without APS on one or more of the following measures.

- Locating the crosswalk
- Aligning to cross and maintaining alignment while crossing
- Use of pushbuttons
- Identifying the WALK interval
- Delay before beginning to cross
- Independence in any or all crossings tasks

Projects that have already been mentioned are: SKERI research; NEI Portland pre-post; Uslan et al, (1988); Marston and Golledge, (2000) and Williams et al. (2005).

There are several additional studies that shed light on this topic. As part of NEI research, in three different experiments Wall, Ashmead, Bentzen and Barlow (2004), blind and blindfolded sighted participants made crossings at a simulated intersection, in the presence of recorded traffic sound to determine the effect on crossing accuracy with signals comprised of bird calls, percussive “toks,” a click train, or a female voice. The signals, all of which were mounted at a height of eight feet, came either simultaneously from both ends of a crosswalk (typical practice), alternated from one end to the other, or came from the far end of the crosswalk only. These researchers also compared crossing accuracy when signals came from two parallel crosswalks (typical practice), or from a single crosswalk. A further comparison was between WALK signals with a typical 7sec. duration versus a seven sec. WALK signal followed by a locator tone.

Hulscher (1976) reported an estimate by Leith (personal communication) comparing starting delay pre- and post-APS installation.

Wilson conducted a pre- and post-APS installation study of behavior of adult, non-disabled pedestrians at one intersection.

Further, the research undertaken for NCHRP 3-62 (REF final report chapters) contributed to the understanding of the effects of APS on specific crossing tasks.

## RESULTS OF RESEARCH

### *Locating the crosswalk*

SKERI research found that starting crossing from within the crosswalk increased from 70% to 97% with use of the APS.

NEI Portland pre-post research found significant increases in participants' ability to begin crossings from within the crosswalk at locations where pushbutton use was required, and pushbutton locator tones were installed. Pre-installation, 77% of crossings began from within the crosswalk; post-installation, 97% of crossings began within the crosswalk, indicating that locating the crosswalk was significantly improved by the presence of pushbutton-integrated APS. (Barlow, Bentzen, Bond and Gubbe, 2006)

### *Orientation (Aligning to cross and maintaining alignment while crossing)*

APS have some affect on aligning to cross, but results have not been as positive as desired.

On 48% of crossings in SKERI research, where APS information was not available, blind pedestrians were not facing directly toward the opposite corner when they started their crossing; they were facing somewhat toward or away from the center of the intersection. With the use of receiver-based APS, participants were well aligned when beginning 80% of crossings.

However, in NEI Portland pre-post research, alignment showed only a very small trend toward improvement, with 70% of independent crossings starting from an aligned position pre-installation and 84% post-installation.

NEI research (Wall, et al, 2004) found the presence of a locator tone during the second half of the crossing had a positive effect on alignment.

In the NCHRP 3-62 research on device features, statistical analyses revealed no differences in orientation attributable to device in Tucson, and only a few minor differences in Charlotte. These differences are easily explained by unique characteristics of the given intersection or pole placements, and taken together with the lack of findings in Tucson, suggests that none of the differences in APS device features on different manufacturer's APS had an important impact on pedestrian orientation. (See NCHRP 3-62 Final Report, and Bentzen et al, in press.)

Various means of beaconing and providing directional information to blind pedestrians are being investigated in the NEI research, including increasing the volume of the locator tone and providing it from a directional speaker, and an orientation tone which involves increasing the volume of the locator tone on the opposite end of the crosswalk, before the crossing interval, in response to a request. Data collection and analysis of results from these experiments are not complete.

## *Using pushbuttons*

Data reported in NEI pre-APS installation testing (NEI-2 cities, NEI-3 cities) indicated that blind pedestrians typically didn't search for and use pedestrian pushbuttons at unfamiliar intersections. In Portland, after installation of APS with locator tones (NEI Portland pre-post), participants were not instructed to use the pedestrian pushbuttons, nor were they provided with instruction about the fact that pushbuttons were needed to call the WALK interval at some of the crossings. However, the addition of pushbutton locator tones and the knowledge that an APS might be installed resulted in participants looking for the pushbuttons on over 98% of crossings, although looking for the pushbutton did not always result in finding and using the correct pushbutton. Participants independently looked for and used the pushbuttons on 93% of the crossings after pushbutton locator tones were installed. In the pretest situation, pedestrians had looked for and used pushbuttons on only 16% of crossings.

NCHRP 3-62 research (See NCHRP 3-62 Final Report and Bentzen et al. in press) reported that while pedestrians who are blind do not typically use pushbuttons when making unfamiliar crossings, after being made aware of the function of the pushbuttons to call the WALK interval, and hearing the demonstrator locator tones, 100% of participants in Tucson and Charlotte searched for the pushbutton. Participants in both cities said they used the locator tone when locating the pushbutton on most trials, regardless of device. However, presence of a pushbutton locator tone did not guarantee that participants would find and push the correct pushbutton. Errors in finding the correct pushbutton were reported, leading to recommendations for instruction in understanding and using tactile arrows, as well as maintaining orientation while looking for pedestrian pushbuttons.

## *Initiating the crossing*

APS have been found to positively affect measures of delay in beginning to cross, starting crossing during the WALK interval, and completing crossings before the onset of perpendicular traffic.

### **Delay in beginning to cross**

Hulscher (1976) cites a personal communication from Leith (1975) in which Leith estimated that, following APS installation, delay in beginning crossings was reduced an average of 2-3 seconds for all pedestrians.

Wilson (1980) in a pre- and post-APS installation study of adult non-disabled pedestrian behavior at one intersection., found the following results.

- For pedestrians using the pushbutton, delay in beginning crossings was reduced by 20%, from 2.7 sec to 2.1 sec.
- The time taken to cross by persons who started during the WALK interval decreased by about 5%; crossing time for other pedestrians was unchanged.

- For pedestrians who arrived at the crossing during the flashing or steady DONT WALK and who waited to cross until the onset of the WALK interval, the proportion who failed to complete their crossings before the onset of opposing traffic was reduced by one-half, from 22% to 11%.

Williams et al. (2005) found that mean latency in beginning crossing without APS was more than 5 seconds, which was reduced to 2.2 seconds with a receiver-based APS device with a tone WALK indication and 3.8 seconds with a pushbutton-integrated APS using speech messages.

In NEI Portland pre- post research, in 144 crossings pre- and post-APS installation at two intersections in Portland, Oregon, the weighted mean starting delay for blind pedestrians without APS was 5.1 seconds, and after APS installation, the delay was reduced to 2.9 seconds. Uslan et al, (1988) also found significant differences between speed of crossing at control intersection and intersections where APS were installed; crossings at locations with APS were completed faster.

Williams et al. (2005) assessed participants on total number of signal cycles missed before crossing. Without APS, mean wait time was almost 2 full cycles, while with either type of APS, the mean wait time was just over a half a cycle.

In NCHRP research different WALK indications have been found to affect latency to begin crossing. (See NCHRP 3-62 Final Report, Chapter 2,).

### **Starting during WALK, and completing crossing before the onset of perpendicular traffic**

In SKERI research, participants began crossing during the WALK interval on only 66% of crossings without APS, but on 99% of crossings with APS.

In NEI Portland pre-post research, without APS the pedestrian-actuated crossings were highly problematic for pedestrians who are blind. Pre-installation, participants began crossing during WALK on only 25% of crossings. Post-installation, there was dramatic improvement in participants correctly determining the appropriate time to start crossing with 84% of crossings initiated during WALK. Similarly, participants completed crossing after the onset of perpendicular green on 50% of crossings pre-installation with a significant decrease, post-installation, to 12% of crossings completed after the onset of perpendicular green.

Furthermore, only 77% of decisions about when to start crossing were made independently pre-installation as opposed to 95% post-installation. Pre-installation, the total number of crossings where the individual independently determined a start time and actually began crossing during the WALK interval was less than a quarter of crossings. Post-installation, with the addition of the APS, there was a significant increase both in independence and in beginning to cross at the appropriate interval.

For crosswalks where the pedestrian phase was on recall, the APS sounded at the beginning of the WALK interval, regardless of whether the pushbutton was used or not. The WALK indication only sounded for the first seven seconds of the



WALK interval, unless the pushbutton was pushed again. Pre-installation, 70% of independent crossings began during the WALK interval; post-installation, this increased to 100%.

Marston and Golledge (2000) found that at crossings without APS, almost half (48%) of the participants attempted to cross during the steady DONT WALK interval, a time recorded as unsafe by the researcher. With access to the pedestrian signal information provided by APS, no participant started crossing at an unsafe time.

## Effect of APS on independence and confidence

Both independence and confidence affect the likelihood that people who are blind will cross streets independently. Lack of independence and low confidence in ability to cross safely result in lack of participation in normal community life.

### INDEPENDENCE

Both the NEI research and earlier SKERI research on which the method was based measured independence on three street-crossing tasks both with and without APS: locating the crosswalk; starting to cross within the WALK interval; and completing the crossing. The NEI research also measured independence on aligning to cross. The percent of crossings on which participants were independent on each task is as follows.

TASK	WITHOUT APS		WITH APS	
	SKERI	NEI	SKERI	NEI
Locating crosswalk	81%	81%	99%	95%
Aligning to cross	NA	94.5%	NA	97%
Starting to cross during WALK	76%	79%	100%	92%
Completing the crossing	81%	86%	97%	96%

**Table C-1.**  
Percent of crossing tasks on which participants were independent.

### Confidence

Marston and Golledge (2000) measured confidence in street crossing with and without APS. The range of responses for the no APS condition, by street crossing task, was 2.7-3.5 (5 pt. scale; 1=no confidence, 5=very confident), while the range of responses by task for the APS condition was 4.8-5.0.

# Effects of WALK signal characteristics

## INTRODUCTION

**Access Board Draft Guidelines for Accessible Public Rights-of-Way (revised 2005) and this APS Guide recommend using a rapid tick WALK indication. Research on WALK signal characteristics, described in this section, is the basis for that recommendation.**

It is important that any audible WALK signal be detectable and localizable, and, if it is a speech message, it must also be intelligible. Two factors make it difficult to satisfy these requirements. First, both detection and localization are influenced by the ambient sound, especially the sounds of vehicles. Second, any degree of hearing impairment makes it more difficult to detect and localize sounds and to understand speech. One might think that simply making the WALK signal loud enough would overcome both problems. However, the problems are much more complex.

Not only volume, but the nature of the sound, that is, the spectral and temporal characteristics must also be taken into account. A body of research, reported below, describes research to identify the characteristics of sounds or messages that make them detectable, localizable, and intelligible. Some of this research particularly addresses detectability, localizability and intelligibility for people with hearing impairments.

There are also important limits to the amount of WALK signal noise that will be tolerated in neighborhoods, and limits to signal volume that are based on OSHA requirements. Furthermore, if the WALK signal is too loud, it may make it difficult for pedestrians who are blind to hear the sounds of vehicles that are about to cross their path.

APS available today respond to ambient sound, providing WALK signals that are louder when the ambient sound is high, such as when a large truck accelerates, and quieter when the ambient sound is low, such as at night. This greatly increases the public acceptance of APS.

APS users must not only be able to detect the WALK signal and localize it, they must be able to quickly and unerringly determine which crosswalk the signal is for. The nature of the signal and its location are critical in the performance of this important part of the street-crossing task.

## RESULTS OF RESEARCH

### *Hearing and blind pedestrians*

A majority of persons who are severely visually impaired are age 65 or older, and typically have some amount of upper frequency, age-related, hearing loss. In addition, the incidence of hearing loss in people with visual impairments is higher than for the general population because a number of causes of blindness also result in hearing loss.

Upper frequency hearing loss results in a decrease in the ability to localize sound and to understand speech, particularly in noisy environments (Wiener & Lawson, 1997).

### *Characteristics of traffic sound*

The sound produced by vehicular traffic is concentrated in the low frequencies, especially for vehicles that are accelerating from a stop. The noise produced by accelerating vehicles is approximately 10 dB louder than that of vehicles traveling at a constant rate of speed. The mean intensity of accelerating traffic, measured from the position of a pedestrian waiting to cross streets in residential and small business areas, was found by Wiener and Lawson (1997) to be 89 dB, equal to the maximum APS volume currently permitted by the MUTCD. (The 89 dB maximum in the MUTCD was based on OSHA 8 hour exposure limits). This means that signals at their maximum permitted volume will sometimes be difficult to hear.

### *Detectability*

Hulscher (1976) found that, because of the masking of high frequency signals by predominantly low frequency traffic noise, and because a majority of blind pedestrians have some upper frequency hearing loss, the optimal fundamental frequency of the WALK tone should be between 300 Hz and 1000 Hz, and the tone should be comprised of multiple short bursts of sound to aid localization.

Staffeldt (1968), in research cited by Hulscher (1976), conducted extensive testing of APS at crossings where they were mounted on the pedestrian signal head, and found that an 880 Hz signal was most detectable in a background of traffic noise.

Hulscher's recommendation and Staffeldt's result was supported by Poulsen (1982) who compared the noise spectrum of traffic as attenuated by windows to arrive at a recommended signal frequency (880Hz) that would not be largely masked by traffic noise, but would also not transmit through windows and become a public annoyance.

In San Diego research, laboratory measurements of "birdcall" signals from Nagoya Electric Works of Japan found that neither signal was highly directional. However, the cheep was more detectable than the cuckoo. The cheep was produced by a continuous frequency variation with a fundamental frequency base of 2800 Hz and the cuckoo consisted of two frequencies with a combined frequency base of 1100 Hz. (currently available "cuckoo/cheep" signals may vary from this manufacturer's standard.)

Hall, Rabelle & Zabihaylo (1996) worked with audiologists to develop a signal that provided the most localizable melody for an accessible signal and recommended a melody that was composed of fundamental frequencies between 300 Hz and 1000 Hz, but including harmonics extending to 7000 Hz.

In NEI research (unpublished data), Wall, Ashmead, Barlow, and Bentzen carried out a series of experiments on detectability of WALK signal indications in a laboratory setting. Experiment 1 evaluated the detectability of signals in white noise, experiment 2 evaluated the detectability in traffic noise, and experiment 3 evaluated detectability in

traffic noise for subjects with age related hearing loss. Signals evaluated were an 880Hz square wave, a bird chirp, a cuckoo, two click trains, two percussive signals (“bink” and “tok”), a 4-tone melody, and female and male voice signals. Results indicated that audible signals of a more percussive nature with predominantly lower frequencies were best heard in background traffic noise. In addition to one of the percussive signals, participants with age related hearing loss were better able to detect male voice signals. Signals with a simple percussive nature tended to need less gain to be heard in noise, relative to the levels necessary to be heard in quiet. In other words, percussive signals were more detectable at lower volumes. When asked their preference, most participants liked voice signals best, but all of the voice signals needed more gain to be heard. Note that the measurement in these studies was the point at which the signal was detected, not the point at which the message was easily understandable. Intelligibility of voice messages was not evaluated or assessed by participants. The cuckoo and chirp, most commonly used in the U.S. as an audible signal at the time of the study, required the most gain to be detectable amidst background noise.

### *Localizability of WALK signal*

An additional factor, if audible pedestrian signals are to be used as beacons to guide pedestrian with visual impairments across a street, is how well signals can provide directional information. Laroche, Giguère and Poirier (1999) compared localization of cuckoo and cheep signals to localization of four four-note melodies varying in fundamental frequencies, harmonics, note duration, and temporal separation between notes. In combined objective and subjective testing, the cheep and a melody with minimal harmonics were found to be less localizable than the cuckoo and the other three melodies. In a follow-up study, Laroche, Giguère and Leroux (2000) compared the typical cuckoo-cheep sounds used in Canada with a cuckoo having a lower fundamental frequency, and the melody that was recommended as a result of their 1999 research. In both studies, the signal was 36 seconds long (much longer than typical U.S. WALK indications) and the measurements were in a simulated pedestrian corridor in a quiet environment. In situations with actual traffic sounds, the cheep was found to result in significantly greater veering and longer crossing time than any of the other signals, which did not differ from each other.

In NEI research, Wall, Ashmead, Bentzen and Barlow (2004) found no significant differences in localizability among several disparate signals including cuckoo, chirp, “tok” and voice messages when tested in research that involved multiple crossings of a simulated street, in the presence of recorded vehicular sound. The five signals used were representative of signals in wide use, or which showed promise for directional beaconing. None of the analyses indicated any systematic differences between the five signals. Further experiments focused on presentation mode and signal location, rather than signal sound characteristics.

### *Speech WALK indications*

Several APS systems in the U.S. are capable of producing directly audible speech messages, either from a speaker that is integrated into the pushbutton housing,

or from a speaker at the pedestrian signal head. APS with speech messages are considered by many people to be especially user-friendly, when demonstrations are given indoors, to an audience for whom English is the predominant first language. However if messages are not correctly understood by users, APS with speech messages, especially speech WALK indications, can lead to catastrophe.

Intelligibility of speech messages is influenced not only by the relationship between signal volume and ambient sound, but also by the nature of the message, how familiar the hearer is with the English language, and any kind of hearing impairment that the user may have.

### **Understanding speech in noise**

Listeners with normal hearing require that speech be 15 dB louder than background noise for intelligibility to reach 90% (Killion, 1999). This means that, in order to be intelligible, speech messages should be louder than tone indications. The effect of that louder sound level on the ability of blind pedestrians to hear other sounds in the intersection, or on near neighbors, may limit the acceptability of speech messages. At this time, MUTCD and Draft PROWAG limit the output of APS to 5 dB above ambient sound, except when special actuation requests a louder beaconing signal for a single pedestrian phase. As noted in the section on detectability, speech messages can be detected in traffic sounds, but that does not guarantee that they can be understood.

### **Speech WALK message structure and wording**

Bentzen, Barlow and Franck (2002) conducted research to obtain information from stakeholders regarding the structure and content of speech messages for APS WALK messages and for “pushbutton information messages” that are available during flashing and steady DONT WALK only. WALK messages convey that the WALK signal is on, and provide the name of the street being crossed. Pushbutton messages provide intersection and crosswalk identification information, and may also provide information about unusual intersection signalization and geometry.

The research utilized an expert panel of stakeholders, who prepared a survey comprised of sample messages to rate, and items to determine respondent understanding of messages. The survey was administered to people who are visually impaired, O&M specialists, transportation engineers, and APS manufacturers.

Speech WALK messages should provide information to pedestrians who are blind that is similar to the information being provided to pedestrians who are sighted. The message should not be worded in a way that seems to provide a ‘command’ to the pedestrian. For example, ‘Cross Howard Street now’ would not be an appropriate message.

Messages also should not tell users that it is “Safe to cross.”

Research resulted in recommended messages for the WALK interval, which include beginning with the name of the street being crossed, for example, “Broadway, Walk sign is on to cross Broadway”. Recommended messages begin on page 4–8 of this APS Guide.

### **Effect of Speech Messages on all pedestrians**

Van Houten, Malenfant, Van Houten and Retting (1997) found that redundant information conveyed by audible pedestrian signals increases the attention of all pedestrians to turning traffic and may contribute to a reduction in pedestrian-vehicular conflicts and crashes at signalized intersections. Their research in Clearwater, Florida used prototype speech message technology in which speech messages were broadcast from the pedestrian signal head. When the pedestrian push button was pressed, the message was “Please wait for WALK signal.” The message “Look for turning vehicles while crossing [street name]” began 200 msec before WALK signals were illuminated.

The signal also gave participants who were blind precise information about the onset of the WALK interval and which street had the WALK interval.

# Accuracy and speed in identifying WALK indication for a given crossing

## INTRODUCTION

Access Board Draft PROWAG and the APS Guide emphasize the importance of installation location for APS. Installation location is critical for accurate and fast identification of which crosswalk has the WALK signal. Research on WALK signal location and tone, described in this section, was the basis for that recommendation.

APS must provide unambiguous information regarding which crosswalk has the WALK indication. A pedestrian who mistakes the signal for one crossing from a corner, for the signal for the other crossing, is at risk of making a crossing when vehicular traffic has the right-of-way and pedestrian crossing is not permitted. A two-tone system such as cuckoo/cheep has long been assumed to provide unambiguous information, however San Diego surveys and Uslan et al. noted problems with this system. ACB and AER surveys confirmed that there were numerous problems with it.

Speed in identifying the WALK signal for the desired crossing is related to delay in starting to cross. The most desirable signal from this perspective is one that is quickly identified, enabling users to initiate crossings promptly, and to finish crossing before the onset of perpendicular traffic.

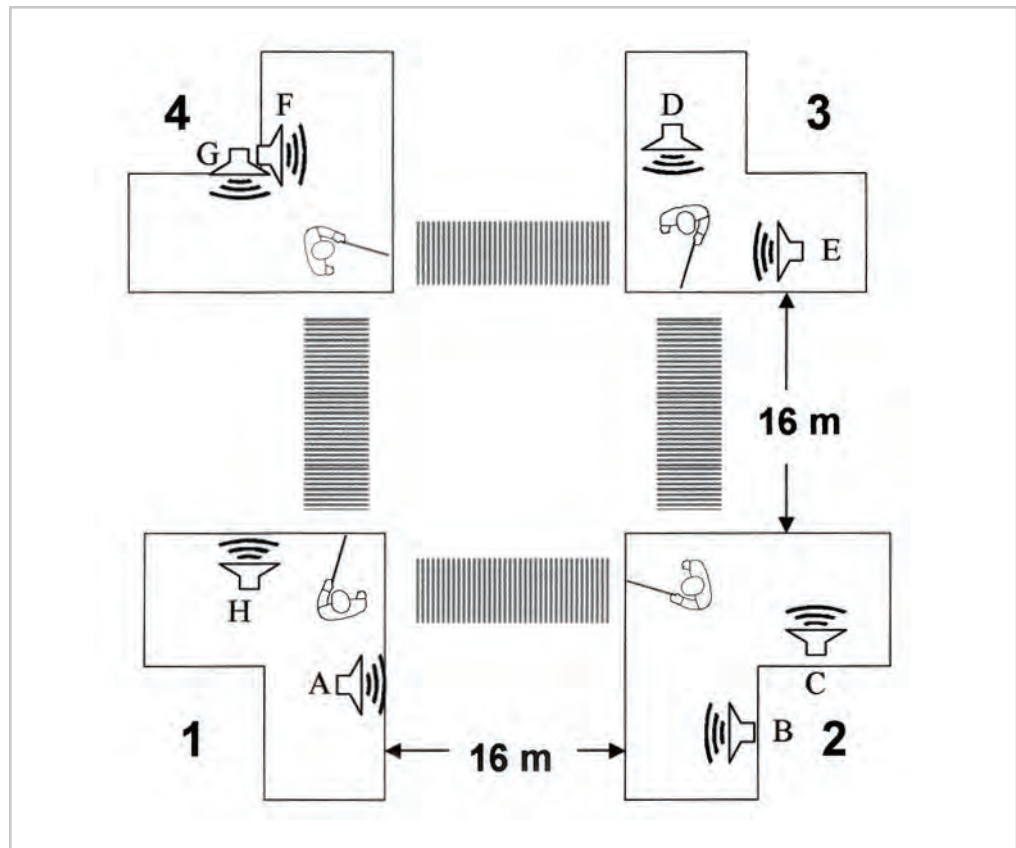
## RESULTS OF RESEARCH

In NEI research, Ashmead, Wall, Bentzen and Barlow (2004) investigated the effects on accuracy and speed of identifying the correct crosswalk, of location of APS speakers located in different positions relative to the crosswalk (see figure C-1 below for APS positioning used in research), using typical placements seen in the U.S.

Under the most typical signal mode, simultaneous presentation from both ends of the crosswalk, the most accurate performance occurred when signals were placed close to the curb line, near the side of the crosswalk that was furthest from the center of the intersection (see corner 1 in figure C-1). The pedestrian could easily tell which of the two loudspeakers at the corner was active because each loudspeaker was close to the position of the pedestrian waiting to cross at the associated crosswalk. Note that this was true despite the fact that both signals on the corner had the same sound. Other arrangements of loudspeakers resulted in somewhat worse performance. Accuracy at corner 3 was poor, with participants answering correctly on only 25% of trials in the simultaneous presentation condition and 50% of trials in the alternating presentation condition.

There was no evidence that response time differed across the four corners, that is, for different speaker arrangements. This suggests that the inaccurate judgments made from corner 3 about which crosswalk had the WALK signal did not reflect uncertainty, but rather were mistakes of which the participants were largely unaware.

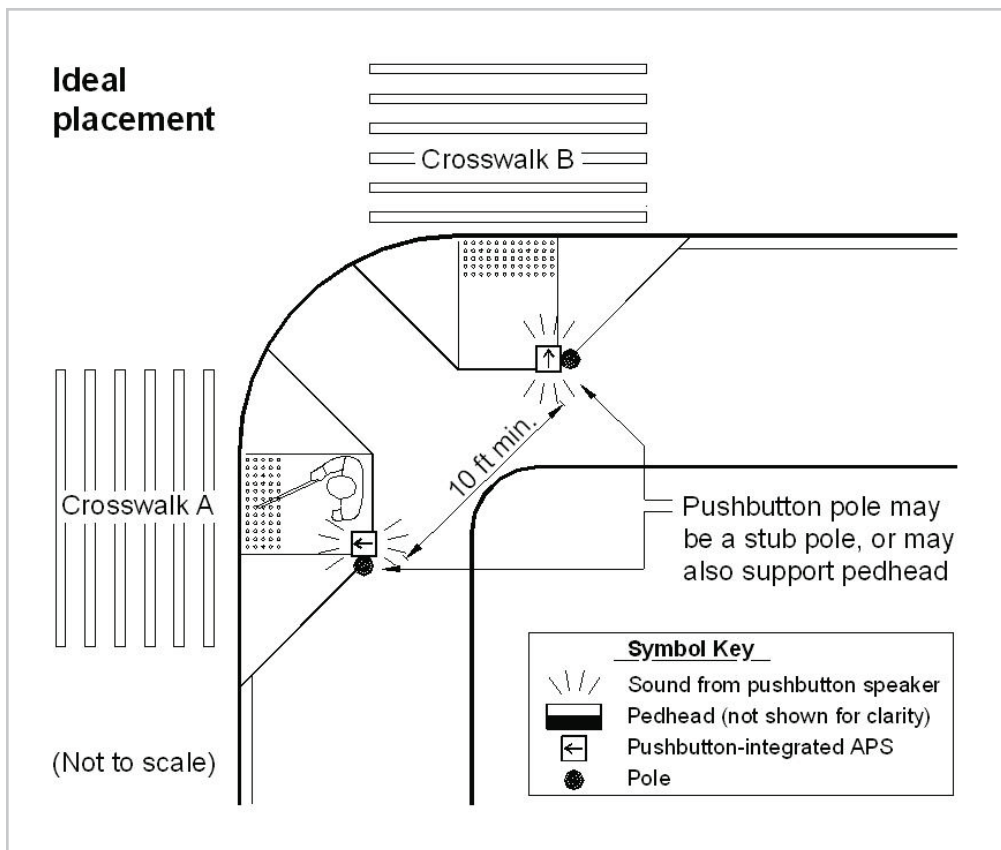




**Figure C-1. Positions and headings of loudspeakers and pedestrians at each corner in NEI research. (Figure from Ashmead, et al., 2004) Note: The question to the pedestrian always was, “Which has the WALK signal, the crosswalk straight in front of you or the one to your right?”** Corner 1: loudspeakers near curb, on outside of crosswalk line. Corner 2: loudspeakers near back edge of sidewalk, on outside of crosswalk line. Corner 3: loudspeakers near curb but facing across pedestrian’s position. Corner 4: loudspeakers near back edge of sidewalk mounted on the same pole. The figure is not drawn to scale.

The above graphic illustrates the recommended placement of APS devices in relation to the crosswalk provided in the APS Synthesis in 2003. This arrangement was based on the NEI research described above. However, the Panel for the NCHRP Project 3-62 asked for additional research to determine if use of two poles at each corner was necessary, or if installation of two devices on one pole could result in accurate and fast identification of which crosswalk had the WALK indication.

Both the location of pushbutton-integrated APS, and various associated signals were investigated under NCHRP 3-62 at an intersection in Portland, Oregon. (See Figure C-3 for the locations of APS on each corner, and the sounds associated with each.). Ninety participants who were blind, who had low vision, or who had cognitive disabilities made all eight approaches to a 4-way intersection, were asked to push the button for to cross the street in front of them, and then to indicate when the WALK signal came on for the street in front of them. (Participants did not cross the street except as they were guided from one corner to the next). (See 3-62 Final Report and Scott, Myers, Barlow and Bentzen, 2006.)

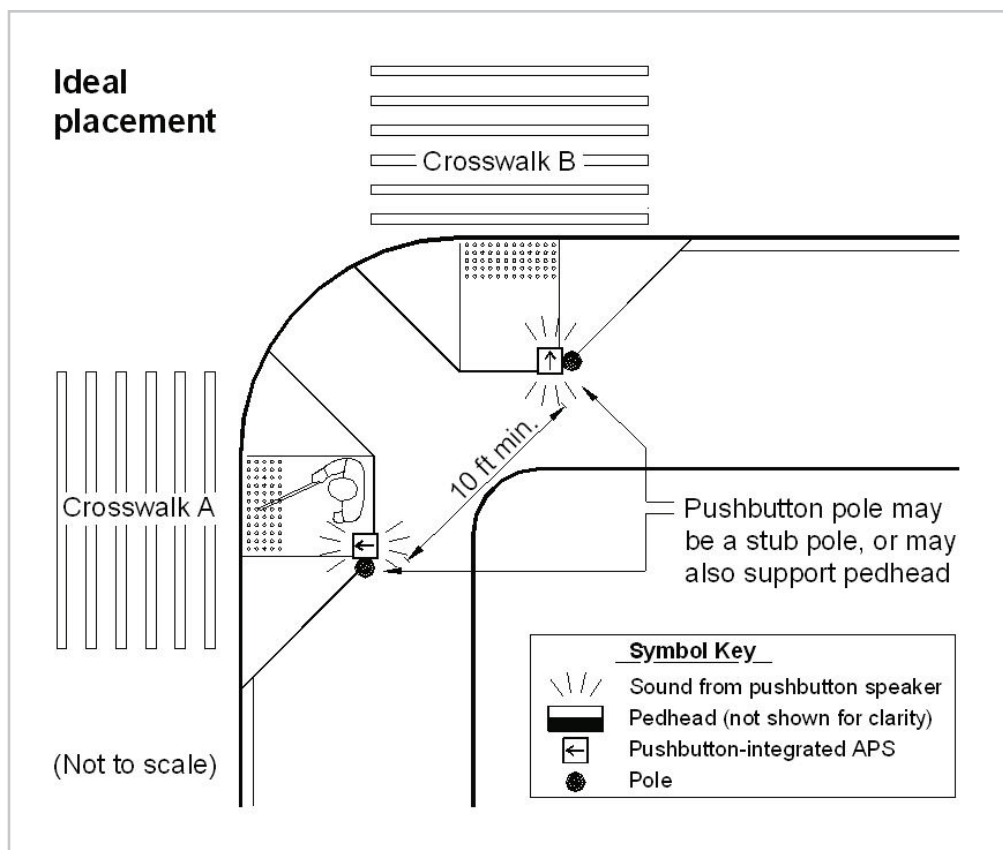


**Figure C-2. Optimal location of pushbutton-integrated APS.**

Results indicated that where pushbutton-integrated APS were mounted on separate poles, near the crosswalk line furthest from the center of the intersection, approximately 3 feet from the curb line, and approximately 10 feet apart, accuracy in judging when the correct crosswalk had the WALK signal was significantly better than when APS were located according to other criteria (see corner C, Figure C-3). On Corner C, participants in the totally blind and legally blind subgroups indicated that the street in front of them has the WALK signal, when in fact the WALK signal was to cross the street beside them, on only 7.55% of trials. For all other tested arrangements, the same participants made this type of error on at least 26.9% of trials. Responses to the onset of the correct WALK signal were also significantly faster at corner C.

For the two subgroups with the least vision, use of two different tones, when APS speakers were located on the same pole, resulted in errors in determining which street had the WALK interval on 50% of trials. Even when APS were located on two separated poles, accuracy in identifying the onset of the correct WALK signal was significantly greater when both APS on the same corner used the same tone (rapid tick) than when the two APS used two different tones (cuckoo and rapid tick). Speech WALK messages, when two APS were located on the same pole, were also evaluated in this research. Speech messages resulted in a much lower error rate than two tones, 19% vs 50%, however locating the APS on two separated poles and using the same tone on each for the WALK indication resulted in an error rate of less than 4%. Locating the APS speakers close to the crosswalk being signaled resulted in much better accuracy in identifying which street had the WALK interval

**Figure C-3. Locations of pushbutton-integrated APS and associated WALK signals in NCHRP 3-62 research**



than variation in WALK indications. The research recommended use of the rapid tick WALK indication because it produced the fastest and most accurate responses regarding which crosswalk has the WALK indication. This recommendation was in conjunction with recommendations for specific locations for the APS.

Participants who had enough vision to see the pedestrian signal (identified in the study as low vision or cognitively impaired) reported that they used the visual signal. However, the results for these groups are in the same direction as the results for the two subgroups with the least vision. It thus appears that the participants who could see the visual pedestrian signals might nonetheless have been influenced by the APS pole arrangement and signal sound.

In research comparing devices having various features, conducted in Tucson and Charlotte under NCHRP 3-62, (see NCHRP 3-62 Final Report; Barlow et al., 2005; Bentzen et al., in press), there were three types of WALK indications used in the devices, speech messages, birdcalls (cuckoo-cheep), and the rapidly repeating tone indication (rapid tick). Once pedestrians understood the crossing signal, the rapid tick provided the best cue in terms of starting to cross quickly in both cities. The faster response to the rapid tick signal confirms results of previous research on pushbutton location and nature of WALK signal, in which responses were faster to the tick than to two different tones or to speech messages.

# Research on source of WALK signal

## INTRODUCTION

Signals that have been typically installed in the U.S. have provided a loud beaoning WALK indication simultaneously from both ends of the crosswalk, and usually from two parallel crosswalks at the same time. As shown in the ACB and AER surveys (refs), pedestrians who are blind often have difficulty if they try to use the APS to indicate the direction of travel on the associated crosswalk. Research has taken place in Canada, Japan, and the U.S. on the effect of source of the WALK signal on accuracy of aligning to cross and of making actual crossings.

## RESULTS OF RESEARCH

### *Presentation mode – simultaneous, alternating, and far side*

Stevens (1993) and Tauchi, Sawai, Takato, Yoshiura and Takeuchi (1998) tackled the problem of improving localization of WALK signals (beacons) by varying the source of the sound. They found that blind pedestrians could cross more quickly and with less veering when the WALK signal alternated back and forth from one end of the crosswalk to the other.

Laroche et al. (2000) confirmed the superiority and subjective preference for an alternating signal for beaoning at a simulated intersection, but found no advantage of the alternating signal when data were collected at an intersection with steady traffic on both streets. This was true for all tones tested (chirp, cuckoo, low cuckoo, and melody). It may have been that blind participants had good directional information from vehicular sound at the intersection or it may have been related to the shorter duration of the APS sound when installed at the intersection. In the previous testing at a simulated intersection (in quiet), the WALK signal continued for 36 seconds, more than the time required for participants to complete the entire crossing. Testing at the simulated intersection was also in a quiet environment.

Poulsen (1982) reported more accurate walking in a simulated crossing setting with a far end signal, than when a signal came simultaneously from both ends, and that far end signal was regarded favorably by a group of blind pedestrians in a field test at a real intersection.

Tauchi, Takami, Suzuki, Kai, Takahara, and Jajima (2001) examined the effects of alternating WALK signals in which the sounds from both ends of a 60 ft. long crosswalk at the top of a “T” intersection with alternating WALK signals were different. Participants were better aligned, and maintained alignment better with the APS with different tones at the end of the crosswalk than with the APS having the same tone at the end of the crosswalk.

Wall et al. (2004) compared the usefulness of auditory signals in guiding crossing behavior in three signal presentation modes, simultaneous, alternating and far side only. In several experiments, blind adults and blindfolded sighted adults crossed a simulated crossing with recorded traffic noise to approximate street sounds. Audible signals were presented simultaneously from both ends of the crosswalk, alternating from one end to the other, or from the far end of the crosswalk only. The signals continued only for the typical U.S. WALK interval of seven seconds, stopping when participants were approximately halfway across the simulated street.

The principal findings were the same for blind and sighted participants and applied across a range of specific signals (e.g. chirps, clicks, voices). Crossing was more accurate when audible signals came only from the far end of the crossing, rather than the typical practice of presenting signals simultaneously from both ends. Alternating the signal between ends of the crossing was not helpful. However, providing a locator tone at the end of the crossing during the pedestrian clearance interval improved crossing accuracy. These findings offer less promise for the usefulness of the alternating signal mode, especially when the findings for single vs dual crosswalks are considered. In previous studies, only one crosswalk was signaled, but this research compared signaling a single crosswalk versus two parallel crosswalks in two experiments. Errors were lower in the alternating mode than the simultaneous mode, but only when a single crossing was signaled. The customary practice of signaling two parallel crossings at the same time seemed to draw participants somewhat toward the center of the intersection.

## Research on other APS Features

Previously described research has also looked at other specific features of APS including the pushbutton locator tone. The following sources are referred to: NCHRP 3-62 research, Barlow et al. 2005 and Bentzen et al., in press; Poulsen, 1982; San Diego research; and Williams et al., 2005.

### PUSHBUTTON LOCATOR TONES

Pushbutton locator tones are a standard feature of almost all pushbutton-integrated APS in use worldwide. In the U.S. they are standardized to repeat once per second, and are to be audible only 6-12 feet from the pushbutton unless there is special actuation to raise the volume during the following pedestrian phase [should it be pedestrian change interval rather than ped phase; it really has nothing to do with completion of the crossing; using that language makes me think of some kind of pedestrian detection] (Manual on Uniform Traffic Control Devices 2003 4E.09; Guidelines for Accessible Public Rights-of-Way, revised 2005). Pushbutton locator tones inform blind pedestrians that they need to push a button to actuate a WALK signal and/or pedestrian timing. Because the sound comes from the pushbutton, it indicates the location of the pushbutton.

Bentzen, Barlow, & Gubbé (2000), compared the speed of blind pedestrians on locating and walking to an APS with a pushbutton locator tone (880 Hz square wave, with multiple harmonics, 3 ms attack time, 15 ms sustained tone) at three repetition rates and three loudness levels relative to traffic sound along an eight lane artery in Los Angeles. Best performance was with a repetition rate of once per second and loudness of 2–5 dBA above ambient sound measured at 1 meter from the locator tone speaker.

### TACTILE ARROW

Tactile arrows aligned in the direction of travel on the associated crosswalk are features of all known pushbutton-integrated APS in use worldwide. Arrows vary in size and location on the APS. Some are on the pushbutton, some are on the vertical face of the housing and some are on the top (horizontal) surface. The length of the arrow varies from approximately 1.5 inches to 2.5 inches; stroke thickness varies from approximately 3/32 inch to ¼ inch; and height above the surface varies from approximately 1/6 inch to ¼ inch.

The only research on usefulness of the tactile arrow for establishing crossing alignment was done in Denmark by Poulsen (1982). The “arrow” tested was a rod on top of the APS that was approximately 2.5 inches in length, ¼ inch in width, and ¼ inch high, with a bump indicating the far side of the crossing and additional bumps indicating the presence of islands or medians, if any. Alignment was equal with or without use of the arrow. The size and graspability of this unique arrow, as well as its location on the top of the APS, are thought to make it a better indicator of direction

than smaller, non-graspable, arrows and those mounted on the vertical face of the APS. The failure to find any positive effect on alignment indicates that such an arrow (or probably any arrow) should not be considered a primary cue for alignment.

Nonetheless, tactile arrows do serve the important purpose of indicating the crosswalk with which a particular APS is associated. Research under NCHRP 3-62 (See Final Report and Bentzen et al. in press) found that increased familiarity with tactile arrows in Tucson and Charlotte resulted in an increase in use of tactile arrows, with arrows actually on the pushbutton being used more frequently than arrows that were not on the pushbutton itself. While participants looked at the incorrect (not desired crossing) arrows on 28 trials in Tucson, after extensive familiarization, they then found and pushed the correct pushbutton on all of these trials. In Charlotte, while there was a decrease in use of the wrong pushbutton following extensive familiarization, use of the wrong pushbutton on some trials remained. Under the same research, subjective responses indicating preference for various features indicated strong support for use of a tactile arrow to identify the correct pushbutton.

## **VIBROTACTILE INDICATIONS**

Most pushbutton-integrated APS worldwide have vibrating tactile arrows or other surfaces that vibrate during the WALK interval. The vibration is required by pedestrians who are deaf-blind to inform them that the WALK signal is on. It is also used by some pedestrians without hearing loss to confirm which crosswalk has the WALK signal, especially in very noisy conditions.

Because it is necessary for pedestrians who are deaf-blind, as well as helpful for blind pedestrians in some situations, a vibrotactile WALK indication is required along with an audible WALK indication in the Draft Guidelines for Accessible Public Rights-of-Way. A signal having vibrotactile indication only is not permitted. An APS that is vibratory only gives no indication of whether there is a pushbutton, or where the pushbutton is located, and it gives no audible directional guidance.

Gallagher and Montes de Oca (1998) surveyed blind pedestrians who were familiar with vibrotactile signals that did not have audible WALK indications, and on which a vibrating arrow was located on a horizontal surface above the pushbutton. They found the vibrotactile signal to be well-liked. In field research, they also found that use of the vibrotactile indication resulted in accurate crossing timing.

## **TACTILE MAP OF THE CROSSWALK**

Maps of the crosswalk are standard features of pushbutton-integrated APS in Sweden, are in wide use around the world where Swedish devices are used, and are required in Austria for all APS regardless of the equipment manufacturer (see Chapter 4 for photos and more information). There does not appear to be any research on the legibility or effectiveness of these maps of the crosswalk, but they do

have the potential to enable users who are unfamiliar with a particular crosswalk to anticipate such characteristics as the number of vehicular lanes in each direction, and the presence of islands or medians, rail tracks, and bicycle lanes.

In NCHRP 3-62 research (see and Bentzen et al., in press) one of four devices compared had a tactile map of the crosswalk. Mean ratings of participant agreement in Tucson and Charlotte to the statement “The crossing map was useful and easy to understand,” were 4.00 and 4.17, respectively, on a 5-point scale (5 = strongly agree). However, even when they were thoroughly familiar with the map, only 9 of 40 participants used it across the two cities.

## **PUSHBUTTON INFORMATION MESSAGE**

On some pushbutton-integrated APS, an optional feature is a speech message that comes from the pushbutton either whenever the button is pushed, or whenever the button is pushed and held in for an extended time (see Extended Button Press, above). This message always begins with the word “Wait”, as it comes on only during the flashing and steady DONT WALK intervals. The next information identifies the intersection and the street to be crossed. The recommended format for this message is “Wait, to cross Howard at Grand.” Additional information may be provided regarding unusual signalization (e.g. split phasing) or geometry (e.g. narrow median in the roadway).

In research conducted under NCHRP 3-62 (NCHRP 3-62 Final Report, Chapter 3; Bentzen et al., in press), three of four devices used in field research in Tucson and Charlotte had pushbutton information messages. On all three devices, the pushbutton had to be depressed for at least three seconds to actuate the full pushbutton information message. One device did not have the standard pushbutton information message when used in Tucson. The objective measure most closely related to the pushbutton information message was only whether participants used the extended button press which actuated the pushbutton information message; it was not possible to observe whether participants actually understood or used the information provided by the pushbutton information message. However, when asked to rate the extent of their agreement with the statement “The pushbutton information message was easy to understand,” the mean ratings for each city were above 4.0 on a 5-point scale (5 = strongly agree), indicating that the message was usually understood.

## **EXTENDED BUTTON PRESS**

Additional features on pushbutton-integrated APS may be actuated by an extended button press. These features include a pushbutton information message, a louder (beaconing) signal, and extended crossing time.

Noyce and Bentzen (2005) found that it was unusual for pedestrians to push pushbuttons for as long as one second. Therefore an extended button-press of only one second is being standardized to actuate any optional features that are available at an APS.



In NCHRP 3-62 research (NCHRP 3-62, Final Report, Chapter 3; Bentzen et al, in press) the extended button press feature was included on three of four types of APS. The extended button press was little used except following familiarization with each device. The extended button press was used on 65-85% of crossings in Tucson and Charlotte following familiarization to device features. This may indicate that specific information and training are necessary for pedestrians who are blind, if use of the extended button press is expected. Desirability of a pushbutton information message as well as beaconing, both of which were actuated by an extended button press, was supported by subjective data.

## AUDIBLE BEACONING

An optional feature on some currently available APS is audible beaconing, which is usually actuated only by an extended button press. Beaconing is provided by a louder signal during the next pedestrian phase. The beacon is intended to aid initial alignment for crossing and crossing within the crosswalk.

In NCHRP 3-62 research (NCHRP 3-62 Final Report, Chapter 3; Bentzen et al, in press), one of four devices tested had the audible beaconing feature. On this device, the WALK signal and subsequent locator tone increased in volume for the next pedestrian phase following a button press of at least three seconds. No objective measure of the use of audible beaconing could be made. The only measure possible was use of the extended button press feature that also actuated a pushbutton information message. However, when asked to rate the extent of their agreement with the statement “The louder signal was helpful,” the mean responses for Tucson and Charlotte were 3.86 and 4.00, respectively, on a 5-point scale (5 = strongly agree), indicating that this feature is desirable.

Additional research on the usefulness of APS for alignment and crossing within the crosswalk is provided under Effect of APS on specific crossing tasks: Results of research: Orientation, above.

## Other concerns and needs

### ENGINEERING CONCERNS

Noyce & Barlow (2003) investigated problems reported with the interface between APS devices and signal controllers to determine whether there were systemic problems with the APS/controller interface. Most problems were found to be installer errors, or wiring problems that had already been corrected by the manufacturer by the time research was conducted.

While the adjustment of the volume of the APS is critical for neighborhood acceptance and for usability by pedestrians who are blind, it continues to be an issue in many jurisdictions. In NCHRP 3-62 research on effect of device features (NCHRP 3-62 Final Report, Chapter 7) researchers found that it was not possible to adjust all devices to have the same perceived loudness, despite extensive efforts and adjustments and involvement by manufacturers' representatives. Perceived loudness is not amenable to objective measurement, and is influenced by conditions such as wind, humidity, precipitation, and nearby reflective surfaces.

APS devices, as with much new technology, have continued to generate maintenance and engineering concerns. As part of NCHRP 3-62 research, devices that were installed for human factors testing were monitored for a year by signal maintenance staff (see NCHRP 3-62 Final Report, Chapter 7). Concerns were expressed about more failures than expected, particularly of the vibratory feature of the devices. Manufacturers were said to be responsive to concerns and were continuously modifying devices to provide better durability.

Case studies of devices installed in cold weather areas were also developed as part of Project 3-62 (see NCHRP 3-62 Final Report, Chapter 6).

### TRAINING NEEDS

In NCHRP 3-62 Research in Tucson and Charlotte, experimenters observed that some participants did not have adequate information or techniques for using pushbuttons and APS devices in crossing streets and many did not have good information and understanding about the complexity of intersection signalization. Of concern to researchers were comments from some participants (prior to any explanation or training in the use of APS) who seemed to be trying to use the fact that the locator tone was sometimes louder in response to ambient sound as a WALK indication. These participants generally did not look for or push the pushbutton, but heard the audible locator tone and without knowledge of locator tones and their function, and made an assumption that it was some kind of WALK indication. This misunderstanding of ambient sound adjustment and the locator tone could lead to dangerous crossings. Where APS with locator tones are installed, it may be necessary to make a concerted effort to provide information about the devices to individuals in the community.

The major reason for the tactile arrow is to enable users to identify which street the pushbutton controls. Many participants in NCHRP 3-62 research and in NEI research needed to be shown the arrows on the devices to understand which way the arrow pointed. Use of the tactile arrow and the incorrect pushbutton presented a very different picture in Charlotte than in Tucson. In Tucson, participants who looked at the arrow on the incorrect pushbutton always correctly rejected the incorrect pushbutton. However, in Charlotte, even following familiarization, participants looked at the arrow on the incorrect pushbutton and failed to reject it on 20% of trials. This confusion in using the correct pushbutton seemed to be related to participants' lack of strategies to maintain their orientation; some would completely turn to face the street parallel to their travel path, while examining the arrow on the device, then push the button and line up to cross the parallel street. Strategies for looking for pushbuttons and aligning to cross need to be taught.

## Need for additional research

At a meeting in September, 2005, the project panel for NCHRP 3-62 developed the following list of issues for additional research:

- Guidance on the need for pushbutton APS on side streets.
- Wayfinding/beaconing (NEI project may address this need)
- Location/size/color of tactile arrow
- Speech message clarity (consistency, programming and downloading messages, standardized library)
- Tactile map (consistency, availability, info on median refuge, guidelines)
- Cold weather issues (future follow-up on case studies, comparison study)
- Tone types (acceptability to nearby residences, which are appealing)
- APS effect on general pedestrian population (tie-in to tone acceptability study?)
- Sound volume (best response to ambient sound, range and speed of response, range of decibel levels, resource is FHWA noise study office)
- Beaconing (volume, duration after press)
- Combining speech message and tones
- Audible message during flashing DONT WALK (tone vs. speech, countdown)
- Design of curb ramps (use in orientation/wayfinding, integration with signal design, effects on pole location)

## References

- Adams, P.F., Hendershot, G.E., and Marano, M.A. Current estimates from the National Health Interview Survey, 1996. National Center for Health Statistics. *Vital Health Statistics*, 10, 200, 1999.
- Ashmead, D.H., Wall, R.S., Bentzen, B.L., & Barlow, J. M. (2004). Which crosswalk? Effects of accessible pedestrian signal characteristics. *ITE Journal*, 74(9), 26–31:
- Barlow, J. M., Bentzen, B.L., Bond, T. and Gubbe, D. (2006) Accessible Pedestrian Signals: Effect on Safety and Independence of Pedestrians who are Blind. *Transportation Research Board 85th annual meeting compendium of papers*. CD-Rom, Transportation Research Board, Washington, D.C.. [NEI Portland pre-post]
- Barlow, J.M., Bentzen, B.L. and Bond, T. (2005) Blind pedestrians and the changing technology and geometry of signalized intersections: Safety, orientation and independence. *Journal of Visual Impairment and Blindness*. 99(10), 587–598. [NEI 3-cities]
- Barlow, J.M. and Franck, L. (2005). Crossroads: Modern interactive intersections and accessible pedestrian signals. *Journal of Visual Impairment and Blindness* 99(10),599-610.
- Bentzen, B.L., Barlow, J.M. & Bond, T. (2004). Challenges of Unfamiliar Signalized Intersections for Pedestrians who are Blind: Research on Safety. *Transportation Research Record: Journal of the Transportation Research Board*, 1878, 51–57. [NEI 2-cities]
- Bentzen, B.L., Barlow, J.M., and Franck, L. (2000) Addressing barriers to blind pedestrians at signalized intersections. *ITE Journal*, 70(9), 32–35. [AER survey]
- Bentzen, B.L., Barlow, J.M. and Franck, L. (2004). Speech messages for accessible pedestrian signals. *ITE Journal*, 74(9), 20–24.
- Bentzen, B.L., Barlow, J.M. & Gubbe, D. (2000). Locator tones for pedestrian signals. *Transportation Research Record* 1705, 40–42.
- Bentzen, B.L., Crandall, W.F., and Myers, L. (1999) Wayfinding system for transportation services: Remote infrared audible signage for transit stations, surface transit, and intersections. *Transportation Research Record* 1671, 19–26. [SKERI research]
- Bentzen, B.L., Scott, A.C., and Barlow, J.M. (in press) Accessible Pedestrian Signals: Effect of Device Features. *Transportation Research Record: Journal of the Transportation Research Board*.

Brabyn, J.A., Haegerström-Portnoy, G, Schneck, M.E., and Lott, L.A. Visual impairments in elderly people under everyday viewing conditions. *Journal of Visual Impairment and Blindness*, 94, 741–755, 2000.

Carroll, J. & Bentzen, B.L. (1999). American Council of the Blind survey of intersection accessibility. *The Braille Forum*, 38(7), 11–15. [ACB survey]

Carter, D.L., Harkey, D.L., Bentzen, B.L., and Barlow, J.M. (in press). Development of an intersection prioritization tool for accessible pedestrian signal installation. *Transportation Research Record: Journal of the Transportation Research Board*.

Centers for Disease Control and Prevention (CDC). “Blindness and Vision Impairment,” Online fact sheet, last update shown as 2003, available at <http://www.cdc.gov/communication/tips/blindness.htm>

Crandall, W., Bentzen, B.L. and Myers, L. (1998). *Remote signage development to address current and emerging access problems for blind individuals. Part I. Smith-Kettlewell research on the use of Talking Signs® at light-controlled street crossings*. Final report, Washington, DC, National Institute on Disability and Rehabilitation Research. [SKERI research]

Crandall, W., Bentzen, B.L., Myers, L., and Brabyn, J. (2001) New orientation and accessibility option for persons with visual impairment: transportation applications for remote infrared audible signage. *Clinical and Experimental Optometry*. 84, 120-131 [SKERI research]

Crandall, W., Brabyn, J, Bentzen, B.L. and Myers, L. (1999). Remote infrared signage evaluation for transit stations and intersections. *Journal of Rehabilitation Research and Development* 36:341-355. [SKERI research]

*Draft Guidelines for Accessible Public Rights-of-Way (Draft PROWAG)*. U.S. Architectural and Transportation Barriers Compliance Board, Washington, D.C., 2002, revised November 2005. Available at <http://www.access-board.gov/prowac/draft.htm>

Gallagher, B., Montes de Oca, P. (1998) Guidelines for Assessing the Need for Adaptive Devices for Visually Impaired Pedestrians at Signalized Intersections. *Journal of Visual Impairment and Blindness*, 92, 633-646.

Harkey, D., Carter, D., Barlow, J.M., Bentzen, B.L., Scott, A.F. and Myers, L. (2006) *Guidelines for Accessible Pedestrian Signals*. Final Report on NCHRP 3-62 to National Cooperative Highway Research Program, Transportation Research Board, The National Academies. [NCHRP 3-62 research]

Hall, G., Rabelle, A. & Zabihaylo, C. (1996). *Audible traffic signals: A new definition*. Montreal: Montreal Association for the Blind.

Health and Activity Limitations post-censal survey (HALS), Statistics Canada, Catalogue No. 89-542-XPE, 1995.

Hulscher, F. (1976). Traffic signal facilities for blind pedestrians. *Australian Road Research Board Proceedings* 8, 13–26.

Islar, Frederick. U.S. Access Board, Memorandum to Federal Highway Administration entitled “INFORMATION: Public Rights-of-Way Access Advisory,” January 23, 2006.

Available at <http://www.fhwa.dot.gov/environment/bikeped/prwaa.htm>

Killion, M.C. (1999). Guilt-free quick SIN [speech in noise]: When to give up on 4000Hz. International Hearing Aid conference V, University of Iowa.

Larouche, C. Giguere, C. and Poirier, P. (1999) Evaluation of Audible Traffic Signals for Visually-Impaired Pedestrians. Final Report, Institut Nazareth et Louis-Braille.

Larouche, C. Leroux, T., Giguere, C. and Poirier, P. (2000) Field Evaluation of Audible Traffic Signals for Blind Pedestrians. San Diego, Triennial Congress of the International Ergonomics Association.

McMillen, Barbara. Handout at ProWalk/ProBike Conference (unpublished), Minneapolis, MN, September 2002.

*Manual on Uniform Traffic Control Devices for Streets and Highways (MUTCD)*. U.S. Department of Transportation, Federal Highway Administration. Washington, D.C., Revision 1, 2003. Available at <http://www.mutcd.fhwa.dot.gov>

Marston, J.R. and Golledge, R.G. (2000) *Towards an accessible city: Removing functional barriers for the blind and vision impaired: A Case for Auditory Signs*. Final Report submitted to the University of California Transportation Center. University of California Berkeley: University of California Transportation Center.

Murakami, T., Ishikawa, M., Ohkura, M., Sawai, H., Takato, J. and Tauchi, M. (1998). Identification of difficulties of the independent blind travelers to cross intersection with/without audible traffic signals. *The 9th International Mobility Conference Proceedings*. Rehabilitation Research and Development Center, Veterans Administration Medical Center, Decatur, GA.

Noyce, D.A. and Barlow, J.M. (2003). *Interfacing Accessible Pedestrian Signals with Traffic Signal Control Equipment*. Washington, D.C.: U.S. Access Board.

Noyce, D.A. and Bentzen, B.L. (2005)). Determination of pedestrian pushbutton activation duration at typical signalized intersections. *Transportation Research Record: Journal of the Transportation Research Board* No. 1939, pp 63–68

Poulsen, T. (1982). Acoustic traffic signal for blind pedestrians. *Applied Acoustics* 15:363-376.

Public Rights-of-Way Access Advisory Committee (PROWAAC). Building a True Community: Final Report, Access Board, Washington, DC, January 2001.

Rehabilitation Act of 1973, U.S. Code Title 29 § 794, 1973.

San Diego Association of Governments. (1988) *Evaluation of audible pedestrian traffic signals*. San Diego Association of Governments, San Diego, CA. [San Diego research]

Schmeidler, E, & Halfmann, D. Distribution of people with visual impairment by community type, prevalence of disability, and growth of the older population. *Journal of Visual Impairment and Blindness*, 92, 380–381., 1998.

Scott, A. C., Bentzen, B.L., Myers, L. and Barlow, J.M. (2005) Experimental Trials on Pushbutton Location and WALK Indicator. NCHRP 3-62, *Guidelines for Accessible Pedestrian Signals, Task 5 Report*, Chapter 3.

Scott, A.C., Myers, L., Barlow, J.M., and Bentzen, B.L. (2006) Accessible pedestrian signals: The effect of pushbutton location and audible WALK indications on pedestrian behavior. *Transportation Research Record: Journal of the Transportation Research Board*, No. 1939, pp 69–76.

Stevens, A. (1993) A comparative study of the ability of totally blind adults to align and cross the street at an offset intersection using an alternating versus a non-alternating audible traffic signal. M.Ed. research report, University of Sherbrooke.

Szeto, A.Y.H., Valerio, N.C., and Novak, R.E. (1991a). Audible pedestrian signals: Part I. Analysis of sounds emitted. *Journal of rehabilitation research* 28(2):57–64. [San Diego research]

Szeto, A.Y.H., Valerio, N.C., and Novak, R.E. (1991b). Audible pedestrian signals: Part II. Prevalence and impact. *Journal of rehabilitation research* 28(2):65–70. [San Diego research]

Szeto, A.Y.H., Valerio, N.C., and Novak, R.E. (1991c). Audible pedestrian signals: Part III. Detectability. *Journal of rehabilitation research* 28(2):71-78. [San Diego research].

Tauchi, M., H. Sawai, J. Takato, T. Yoshiura, and K. Takeuchi. (1998) Development and Evaluation of a Novel Type of Audible Traffic Signal for the Blind Pedestrians, *The 9th International Mobility Conference Proceedings*. Rehabilitation Research and Development Center, Veterans Administration Medical Center, Decatur, GA, pp 108–109.

Tauchi, M., Takami, R., Suzuki, S., Kai, T., Takahara, S., and Tajima, T. (2001). Comparison of disorientation and walking tendency of the visually impaired pedestrians under different types of alternating audible traffic signals. Proceedings of World Congress on Intelligent Transport Systems.

The Lighthouse National Survey on Vision Loss: The Experience, Attitudes, and Knowledge of Middle-Aged and Older Americans, New York: The Lighthouse Inc., 1995.

Transportation Equity Act for the 21st Century (TEA-21), Public Law 105-178, U.S. Congress, June 1998, Revised July 1998. Available at <http://www.fhwa.dot.gov/tea21>

Uslan, M. M., Peck, A. F., & Waddell, W. (1988). Audible traffic signals: How useful are they? *ITE Journal*, 58 (9), 37-43.



Van Houten, R., Malenfant, J., Van Houten, J. & Retting, R. (1997). *Using auditory pedestrian signals to reduce pedestrian and vehicle conflicts*. Transportation Research Record No. 1578. Washington, DC: National Academy Press.

Wall, R.S., Ashmead, D.H., Bentzen, B.L., & Barlow, J. (2004). Directional guidance from audible pedestrian signals for street crossing. *Ergonomics*. Vol. 47, (12), 1318–1338.

Wall, R.S., Ashmead, D. H., Barlow, J.M., & Bentzen, B.L. (unpublished manuscript) Detectability of Audible Pedestrian Signals.

Wiener, W. R., Lawson, G., Naghshineh, K., Brown, J., Bischoff, A., & Toth, A. (1997). *The use of traffic sounds to make street crossings by persons who are visually impaired*. *Journal of Visual Impairment & Blindness*, 91, 435–445.

Williams, M. D., Van Houten, R., Ferraro, J., and Blasch, B. (2005). Field comparison of two types of accessible pedestrian signals. *Transportation Research Board 84th annual meeting compendium of papers*. Washington, D.C.: Transportation Research Board.

Wilson, D.G. (1980). *The effects of installing an audible signal for pedestrians at a light controlled junction*. Transport and Road Research Laboratory, Department of the Environment, Department of Transport, U.K.

# Appendix D: Prioritization Tool Instructions and Forms

Purpose of the Prioritization Tool .....	D-2
Understanding How Blind Pedestrians Cross at Signalized Intersections .....	D-2
Overview of Prioritization Tool Worksheets .....	D-4
Scoring System .....	D-4
Intersection Worksheet Sketch .....	D-5
Intersection Worksheet Variables .....	D-5
Configuration .....	D-5
Signalization .....	D-7
Transit Facilities within a Block (~ 1/8 mile) of Intersection— Any Leg .....	D-9
Distance to Facility Providing Services to the Blind or Visually Impaired .....	D-9
Distance to Major Pedestrian Attractions .....	D-10
Crosswalk Worksheet Variables .....	D-10
Crosswalk Width .....	D-10
Speed Limit (street being crossed) .....	D-10
Approach/Crosswalk Geometrics .....	D-11
Pedestrian Signal Control .....	D-14
Vehicle Signal Control .....	D-16
Off-Peak Traffic Presence .....	D-19
Distance to Alternative APS Crossing .....	D-20
Pedestrian Pushbutton Location (either corner) .....	D-20
Requests for APS .....	D-21
Blank Prioritization Tool Worksheets .....	D-22
Examples of Completed Prioritization Tool Worksheets .....	D-27
References .....	D-34

## Purpose of the Prioritization Tool

Municipalities responsible for the installation and operation of traffic signals are often required to make decisions about the use of accessible pedestrian signals. In many cases, there is a need to prioritize existing signalized intersections for APS installations. Two such cases include:

- 1) where the number of requests exceeds the funding available in a given fiscal year, and
- 2) where transition plans for making intersections accessible are being completed and decisions must be made about the order of installations.

This prioritization tool provides practitioners with the means to take observable characteristics of a pedestrian crosswalk and produce a score that reflects the relative crossing difficulty for pedestrians who are blind or visually impaired. This scoring system enables a prioritization of APS installations within a jurisdiction.

The information regarding prioritizing intersections for installation of APS is **not intended** for application to new or reconstructed intersections. In new construction or reconstruction projects, it is appropriate to consider the *Draft PROWAG* as the best guidance available at this time. This guidance states that in new construction, APS should be installed wherever pedestrian signals are installed.

## Understanding How Blind Pedestrians Cross at Signalized Intersections

*Before discussing how intersection and crosswalk characteristics affect the travel of blind pedestrians, it is important to understand **how** blind and low vision pedestrians travel. This section gives an overview of this issue.*

At any given time, people who are blind or visually impaired can travel and cross streets using a human guide, using a long, white cane to identify and avoid obstacles, using a dog guide, using special optical or electronic aids, or using no additional aid. Whatever aid is used, street crossing is comprised of a number of tasks.

- 1) *Locating the Street*—First, pedestrians who are blind must determine when they reach a street. This is typically accomplished using a combination of cues, including the curb or slope of the ramp, traffic sounds and detectable warnings.
- 2) *Street Recognition*—Next, blind pedestrians recognize or determine which street they have come to. This information is only occasionally provided in any accessible format, so pedestrians who are visually impaired develop a mental map and keep track of where they are within that map, usually by counting blocks and street crossings. Assistance may be sought from other pedestrians.
- 3) *Intersection Assessment*—Next, pedestrians who are blind obtain critical information about intersection geometry, including the location of the crosswalk, the

direction of the opposite corner, the number of intersecting streets, the width of the street to be crossed, and whether there are any islands or medians in the crosswalk. Vehicular sounds, where there is a stream of traffic on each street at the intersection, are used to infer intersection geometry.

Pedestrians with visual impairments also need to identify the type of traffic control system at an intersection. This may be determined by listening to traffic patterns through several light cycles, and searching the sidewalk area for poles with pushbuttons. However, it has become difficult or impossible to determine the type of traffic control at many intersections by listening. The inability to determine whether a crosswalk is pedestrian actuated may result in failure to use pedestrian push buttons and crossing at times other than the pedestrian phase.

4) *Cross the Roadway*—After determining the geometry of the intersection, aligning to face towards the destination curb, determining that the intersection is signalized, and having pushed a button (where necessary), pedestrians who are blind must recognize the onset of the walk interval. In the most common technique utilized for crossing at signalized intersections, pedestrians who are blind begin to cross the street when there is a surge of through traffic on the closest side of the street parallel to their direction of travel. Once pedestrians who are blind have begun to cross the street, they must maintain a heading toward the opposite corner. Turning traffic can make it difficult to establish a correct initial heading, and in the absence of traffic on the parallel street, pedestrians who are blind may veer toward or away from the intersection.

Optimal crossing conditions occur when crossing right angle signalized intersections with a moderate but steady flow of traffic through the intersection on each leg with a minimum of turning movements.

Pedestrian actuation requires blind pedestrians to locate and push a pushbutton, then cross on the next pedestrian phase to be assured of having enough time to cross. Blind pedestrians have three types of problems at these locations:

- 1) They cannot wait through a light cycle to assess and refine their heading by listening to vehicular trajectories, before crossing at the next pedestrian phase because they have to locate and push the button again (and re-establish their heading).
- 2) At a location with little vehicular traffic, even if pedestrians who are blind know there is a pushbutton and use it, they may not be able to detect the onset of the walk interval if there is no through traffic on the street parallel to their crossing.
- 3) Blind pedestrians may not be aware that there is a pushbutton and/or they may be unable to locate the pushbutton. In addition, some locations do not include a pedestrian phase, and at times when vehicular volume is low, there may not be enough time to cross the street.

In the past twenty years, significant changes in intersection geometry, signalization, driver behavior, and the technology of automobiles have affected the ability of blind travelers in the United States to obtain the information they need to cross streets independently and safely. Traffic clearing the intersection also commonly overlaps

the pedestrian phase by as many seconds as the duration of the walk interval. In such cases, blind pedestrians will first perceive the pedestrian phase, and initiate crossing, after the onset of the pedestrian change interval. These changes have increased the requests for APS by blind pedestrians. Municipalities and states need a documented procedure to respond to such requests as required by the program access requirements of the Americans with Disabilities Act.

## Overview of Prioritization Tool Worksheets

The prioritization tool includes three separate worksheets that should be used for rating each intersection (*blank forms included on pages D-21 through D-24*). The first worksheet is the *Intersection Worksheet* and is used for describing characteristics of the intersection as a whole, including space for a sketch of the intersection. The second worksheet is the *Crosswalk Worksheet* and is used for describing the features associated with each crosswalk at the intersection. A separate crosswalk worksheet should be completed for each crosswalk at the intersection. Each of these forms includes variables that either provide an assessment of level of difficulty that may be present for pedestrians who are blind or provide an indicator of the level of pedestrian activity in the vicinity of the intersection. The variables are further defined in the latter sections of this document. Each form also includes space for additional comments to be provided. Finally, a *Supplemental Form* is provided for those locations where more drawings or additional notes may be required.

## Scoring System

The APS Prioritization Tool provides a score for an individual crosswalk. Higher scores indicate a greater priority for APS installation. Lower scores indicate a lower priority for APS. There is no particular score that indicates whether APS should be installed or not. The scores are intended to provide a *relative prioritization* scheme among a group of crosswalks.

**The system of scoring is based on the premise that it is the individual crosswalk that is critical, as opposed to the intersection as a whole. Therefore, priorities for installation should be established on the basis of individual crosswalks, rather than complete intersections.** Jurisdictions may choose to install APS at all crosswalks of an intersection when installing them at one crosswalk. However, the intent is to rank and consider each crosswalk separately. If a scoring system were used that is based on the combined score of all crosswalks at an intersection, a very difficult crosswalk for blind pedestrians combined with three crosswalks that are relatively easy could result in low ranking for the intersection as a whole. Such an intersection-based system could result in critical crosswalks being missed on a priority list.

The total score for a crosswalk is calculated as the sum of the individual crosswalk score and the intersection score. The *Intersection Worksheet* includes the Intersection

Worksheet Score in the bottom right corner. The total crosswalk scores are found in the bottom right corner of each of the *Crosswalk Worksheets*. Each *Crosswalk Worksheet* includes the Crosswalk Worksheet Score and the Intersection Worksheet Score (transferred from the Intersection Worksheet), which are added together to get the resulting Total Crosswalk Score. The Total Crosswalk Scores can be listed on the Cover Sheet for quick reference.

## Intersection Worksheet Sketch

The *Intersection Worksheet* includes space for a simple sketch of the intersection being rated. At a minimum, the sketch should capture the following:

- 1) Crosswalk location and orientation, including skew and any change in direction (each one should be labeled (e.g., A, B, C, and D) for correct reference to the Crosswalk Worksheets.
- 2) Location of pushbuttons and other signal features.
- 3) Geometrics, such as islands and lane configuration.

Additional sketches and notes, as required, should be recorded on the *Supplemental Worksheet*.

## Intersection Worksheet Variables

### CONFIGURATION

Pedestrians who are blind or visually impaired use the sound of traffic moving beside them as an alignment cue and as a cue for determining when the traffic signal changes. Therefore, the number of approaches to an intersection and the geometric configuration affects the difficulty of crossing. A standard 4-leg intersection with perpendicular approaches is the easiest configuration. If those approaches are offset while still controlled by the same signal, the crossing becomes more difficult as it becomes harder to recognize the parallel traffic flow from the minor street. T-intersections are more difficult for similar reasons. Crossing the top of a T-intersection can be problematic due to the fact that the simultaneous traffic flow is from the stem of the T and is either turning right or left. Intersections with more than 4 legs can also result in ambiguous traffic flow cues for pedestrians with visual impairments.

Mid-block signalized locations are most difficult for blind pedestrians because there is no traffic stream parallel to the crosswalk to provide an audible cue. Given this, signalized mid-block crosswalks receive the highest point value in the Configuration category (14 points). Since completing the remainder of the worksheets for a mid-block crossing may prove confusing, the categories that apply to a mid-block crossing have been listed in Table 1 below.

**Table 1.**  
**Applicable Variables for**  
**Mid-Block Crossings**

<b>INTERSECTION WORKSHEET VARIABLE</b>	<b>CAN APPLY TO MID-BLOCK CROSSING?</b>
Configuration	Yes
Signalization	Yes, Actuated
Transit Facilities	Yes
Distance to Facilities for Visually Impaired	Yes
Distance to Major Ped Attraction	Yes
<b>CROSSWALK WORKSHEET VARIABLE</b>	
<b>CROSSWALK WORKSHEET VARIABLE</b>	<b>CAN APPLY TO MID-BLOCK CROSSING?</b>
Crosswalk width	Yes
Posted Speed Limit	Yes
Curb radius > 25 feet	No
Islands or medians	Yes
Transverse slope	No
Apex curb ramp	No
Channelized right turn island	No
Skewed crosswalk	No
Pushbutton actuation required	Yes
Non-concurrent WALK interval	No
Leading Pedestrian Interval	No
Timed for crossing to median island	Yes
RTOR permitted	No
Leading protected left turn	No
Protected right turn overlap	No
Channelized right turn under signal	No
Off-Peak Traffic Presence	Yes
Pushbutton location	Yes
Requests for APS	Yes

## **SIGNALIZATION**

The sequence of phases at a signalized intersection and other features of the signal operation, such as interval lengths and actuation-only phases, affects the ability of a blind pedestrian to determine when it is appropriate to cross. This information is captured in two places. The *Signalization* variable captures information about the general signal operation that may affect the difficulty of crossing any or all streets.

The *Crosswalk Signalization* variable on the crosswalk worksheet captures details about the signal operation that impact a particular crosswalk.

The following signalization options are given on the form. The user should select the option that has the highest point value AND applies to the intersection of interest. For example, if an actuated intersection has an exclusive pedestrian phase, then the user should select only “exclusive pedestrian phase”, since that option has a higher point value than actuation.

*Pre-timed*—Pre-timed signalized intersections are the easiest for a blind pedestrian to understand, since the phase sequence and intervals remain the same in every cycle.

*Actuated*—Actuated signals are more difficult for blind pedestrians since the interval timing may change or phases may be skipped on each cycle. In addition, some actuated signals require the pedestrian to find and push a pushbutton to obtain a WALK interval. Note: This intersection signalization variable is intended to capture actuation associated with vehicular traffic. Pedestrian actuation is captured within the Crosswalk Signalization variable on the Crosswalk Worksheet.

*Split phasing (on either street)*—The auditory cues of split phasing can provide confusing information. Split phasing on the street parallel to the crosswalk can lead a blind pedestrian to believe they have the WALK interval because the cross street traffic is stopped and they hear a surge on the parallel street, not knowing that left-turning vehicles may be present.

In the image on the left in Figure D-1, a pedestrian going north on the east crosswalk (bottom right corner) will have the WALK indication. A pedestrian going north on the west crosswalk (bottom left corner) will have DON'T WALK, since the northbound left turning traffic has a protected turn. Without APS, if a blind pedestrian on the bottom left corner hears the northbound through traffic, they might assume that they have the WALK indication and cross the street—presenting a potentially dangerous conflict with northbound left-turning traffic which has a protected turn.

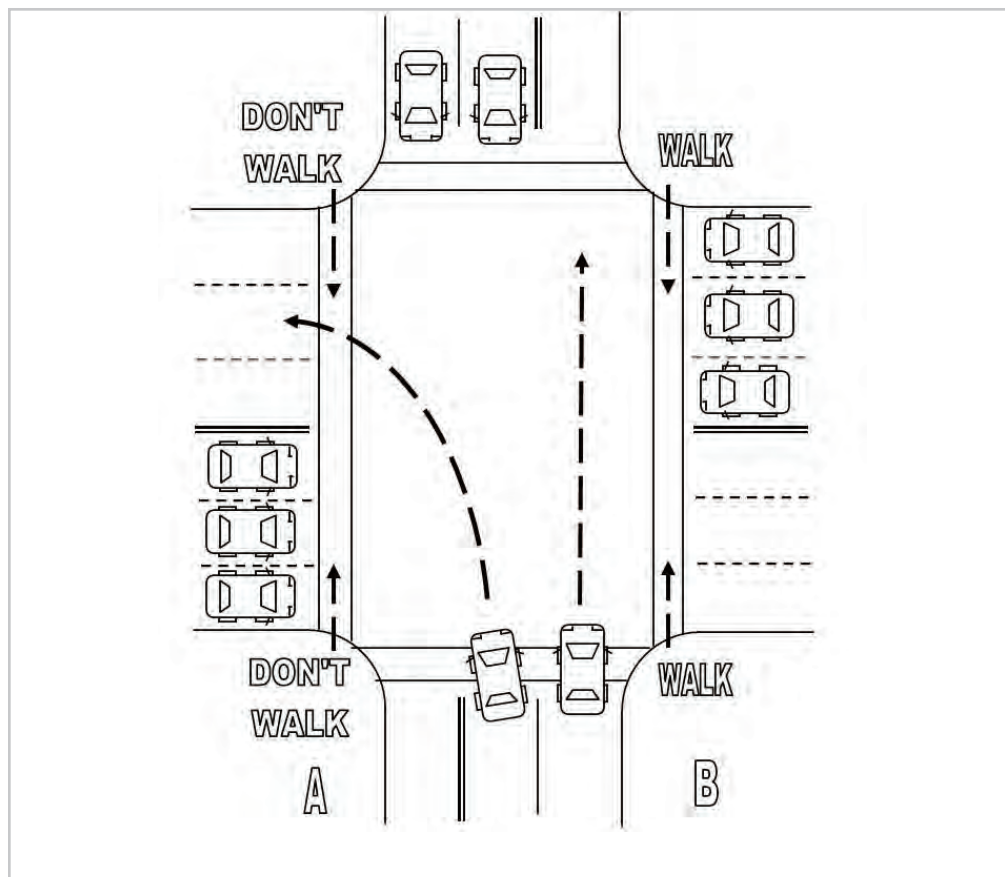
Split phasing on the street to be crossed can also be confusing in that the left-turning traffic onto the parallel street may be mistaken for the parallel street traffic surge. This variable does not include leading protected left turns; that signal feature is covered as a crosswalk-level variable.

*Exclusive pedestrian phase*—An exclusive pedestrian phase forces all vehicular traffic at an intersection to stop. It is much more difficult for a blind pedestrian to determine the onset of a WALK interval when there is no vehicular movement and thus no surge of traffic. A lull in traffic flow may be perceived as the onset of the WALK. However, a lull in traffic may also be perceived as gaps in traffic or changes between phases, rather than the onset of an exclusive pedestrian phase.

Where RTOR is permitted in combination with exclusive pedestrian phasing, an intersection may never be quiet enough for pedestrians who are blind to be sure that the pedestrian interval has begun. If they cross at such intersections independently, they are likely to begin crossing well into the pedestrian clearance interval. Additional points should be added for RTOR (separate variable described below) when present.



**Figure D-1. Split Phase Illustration**



### **TRANSIT FACILITIES WITHIN A BLOCK (~ 1/8 MILE) OF INTERSECTION – ANY LEG**

The availability of transit facilities within close proximity to an intersection will increase the likelihood of blind pedestrians, as well as sighted pedestrians, crossing at that intersection. The probability increases as the number of stops and routes increases, with the greatest probability occurring when there is a major transfer facility present, such as a transit mall or rail station. The levels on the prioritization tool account for transit activity by recording the number of routes that have stops within a block of the intersection. A single route will most likely be on the major street of an intersection. Multiple routes may include multiple major-street routes or a combination of major- and minor-street routes.

### **DISTANCE TO FACILITY PROVIDING SERVICES TO THE BLIND OR VISUALLY IMPAIRED**

The closer a facility for persons who are visually impaired is to an intersection, the more likely it is that pedestrians who are blind or visually impaired will need to cross at that intersection. Facilities that fall into this category include an adult rehabilitation center, library for the blind, residential school for the blind, offices of rehabilitation counselors, and other centers providing services for people who are blind or visually impaired.

Knowing the locations of these facilities will be difficult for any transportation department without good communication with the blind community. It is the responsibility of the department and the blind community to maintain a working relationship with each other. Organizations such as regional associations for the blind would be able to inform the department of any new schools or facilities that provide services to persons who are blind or visually impaired.

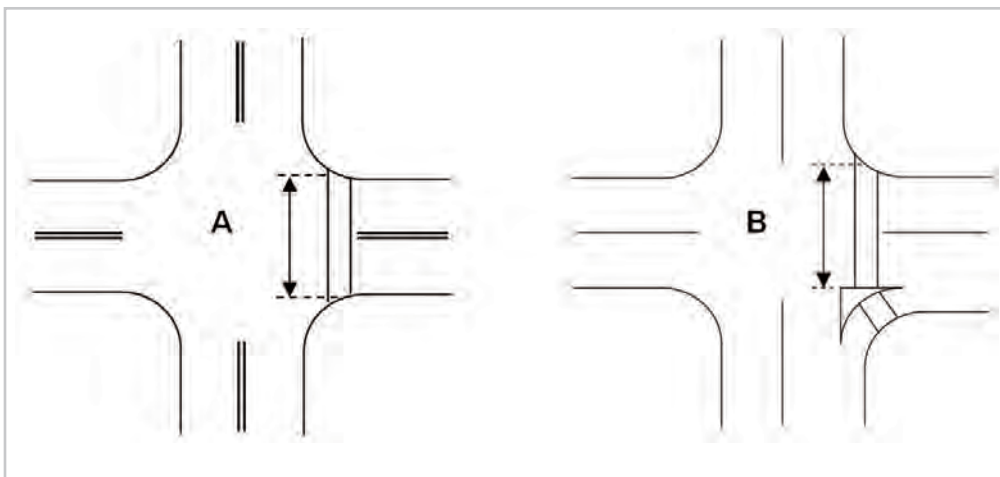
## DISTANCE TO MAJOR PEDESTRIAN ATTRACTIONS

The intent of this variable is to serve as a surrogate measure for pedestrian usage at the intersection without having to make pedestrian counts. Most agencies simply do not have such counts or the resources to acquire such. Major pedestrian attractions include, but are not limited to major shopping areas, major cultural venues, educational campuses, recreational areas and medical facilities. The designation of “major attraction” will depend on the characteristics of the municipality. The idea behind this variable is that higher pedestrian activity will increase the chance of blind or visually impaired pedestrians crossing at the intersection, which would increase the need for APS.

## Crosswalk Worksheet Variables

### CROSSWALK WIDTH

Crosswalk width is defined as the curb-to-curb measurement taken at the midpoint of the crosswalk. A longer crosswalk increases the potential that pedestrians who are blind will veer out of the crosswalk, as well as making it more critical for the blind pedestrian to start as quickly as possible after the onset of the WALK interval. In the case of a channelized right turn island, the crosswalk length should be measured from curb to island (Figure D-2). Widths less than 40 ft receive no points.



**Figure D-2.**  
**Diagram A demonstrates the crosswalk width measurement of a standard crosswalk. Diagram B demonstrates crosswalk width measurement of a crosswalk at a channelized right turn lane.**

## **SPEED LIMIT (STREET BEING CROSSED)**

The higher the speed of the vehicles on the street being crossed, the lower the probability of avoiding an incident should a visually impaired pedestrian mistakenly step into the street and the higher the probability of injury should a crash occur. Since operating speeds are not always available, the posted speed limit can be used as a surrogate measure. Speed limits of 20 mph and lower receive no points.

## **APPROACH/CROSSWALK GEOMETRICS**

There are several geometric factors at a crosswalk that can negatively impact upon the ability of a blind pedestrian to safely cross the street. Each of the factors on the form under this heading is defined below.

### *Curb radius > 25 ft (either corner)*

It is more difficult to establish an initial correct heading where curb radii are wide. Incorrect headings can result in pedestrians who are blind walking toward the center of the intersection.

### *Islands or medians*

Raised or painted crossing islands and medians can confuse blind pedestrians during their crossing, slow or delay their crossing, affect crossing alignment, and generally make the crossing more difficult. Points should be added for any median or island, painted, raised, or cut-through, that crosses the crosswalk, particularly when the crosswalk changes direction at the island. **Islands that are present for channelized right turns are taken into account in the “Channelized right turn island” factor.**

### *Transverse slope on crosswalk (cross slope)*

Crosswalks with a severe cross slope (> 5 %) can lead to veering toward the downhill side by a blind pedestrian during the crossing. Depending on the direction of the cross slope, they could either veer into the intersection or into the approach leg. A beaconing APS may counter this tendency to veer.

### *Apex (diagonal) curb ramp (either corner)*

Where the slope of the curb ramp is not aligned with the direction of travel on the crosswalk, blind pedestrians may misalign for the crossing and walk into the flow of parallel traffic. This misalignment most commonly occurs with “apex” curb ramp configurations (Figure D-3). This apex configuration occurs when the corner only has one ramp that points toward the center of the intersection, usually for the purpose of serving two perpendicular crosswalks. If the corner has two ramps that each serves one crosswalk, the corner has a perpendicular ramp configuration (Figure D-4).



**Figure D-3.**  
Photo and sketch of an apex ramp configuration



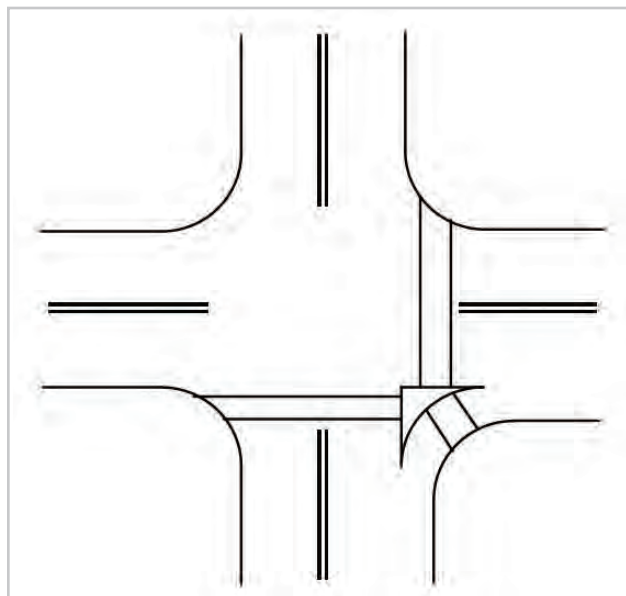
**Figure D-4.**  
Photo and sketch of a perpendicular ramp configuration

### *Channelized right-turn lane island*

Crossings at a channelized right-turn lane normally require the pedestrian to cross to the island in one direction, reorient themselves, and then complete the crossing in a different direction (see Figure D-5). This direction change is potentially confusing to blind pedestrians. Most of the right-turn lanes where such islands are present are unsignalized. Therefore, an APS will not be installed for the right-turn lane crossing unless a traffic signal is being added. The APS installation that should be considered at these locations is on island for the crosswalks that cross the through travel lanes. The locator tones, as well as the WALK interval tones and speech messages, on an APS device under these conditions may assist the visually-impaired pedestrian with the reorientation that is required to find the correct crosswalk.

**Note:** Islands and medians separating traffic lanes in the middle of the road are taken into account by the “Islands or medians” variable. If the right-turn lane is signalized, refer to the “Channelized right turn lane under signal control” variable.

**Figure D-5.**  
**Crosswalks at a**  
**channelized turn island**

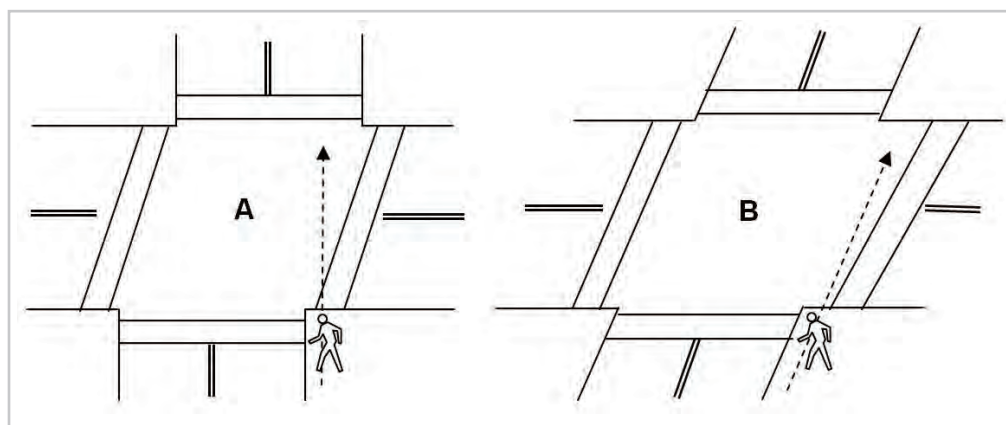


**Skewed crosswalk**

If the direction of travel on a crosswalk is different from the direction of travel on the approaching sidewalk (is skewed), the consequence of failure to establish a heading toward the opposite corner is often that blind pedestrians will walk toward the center of the intersection and into the path of parallel traffic.

The degree of skew can vary from crosswalk to crosswalk. **Skew, in this case, is not defined by the angle at which the streets intersect.** If a blind pedestrian walking a straight line from the approaching sidewalk is headed toward parallel traffic lanes, the crosswalk is skewed (see crosswalk A in Figure D-6). If the blind pedestrian would end up deviating from the crosswalk but would still arrive at the opposite corner, the crosswalk is not defined as skewed for this rating tool (see crosswalk B in Figure D-6).

**Figure D-6.**  
**Crosswalk A is defined**  
**as skewed because a**  
**pedestrian following the**  
**sidewalk line is headed**  
**toward the parallel traffic**  
**Crosswalk B is not skewed**  
**because a pedestrian**  
**following the sidewalk**  
**line is headed toward the**  
**opposite corner.**



Skewing can also occur at crosswalks where the pedestrian walk signal only gives enough time for the pedestrian to reach a median. In this case, the blind pedestrian must be able to find the median to wait for the next signal cycle. A skewed or bent crosswalk may cause the pedestrian to miss the median. In this situation, the crosswalk is defined as skewed (Figure D-7).



**Figure D-7.**  
This crosswalk is defined as skewed because it is timed for median crossing (two-stage) and a blind pedestrian might miss the median due to the bent crosswalk.

Determination of skew should not consider the island of a channelized right turn (Figure D-5). Although crossing from curb to curb may involve a crooked path due to a direction change at the island, this disadvantage is already accounted for in the fields relating to channelized turn islands.

## PEDESTRIAN SIGNAL CONTROL

The ability of a pedestrian who is visually impaired to safely cross at a crosswalk can be impacted by the WALK interval timing and other pedestrian signal control features. Each of these factors is defined below.

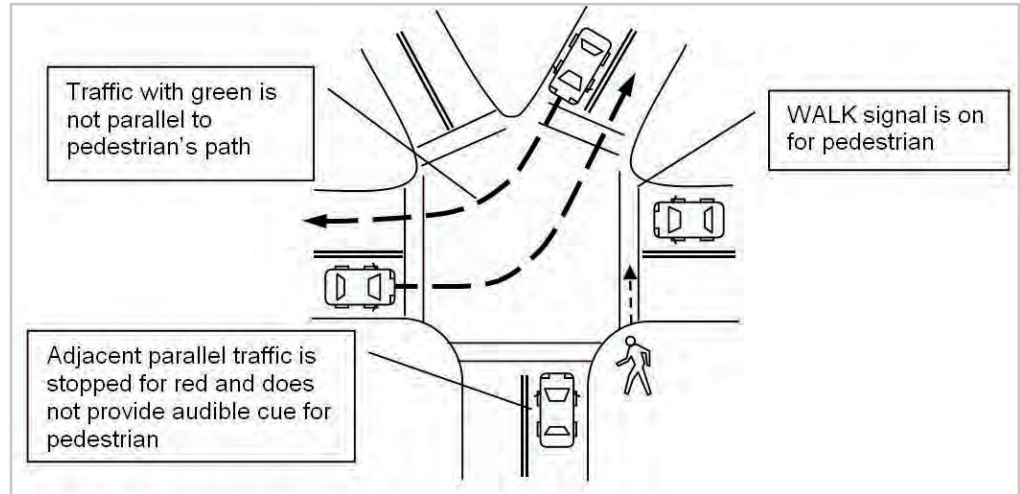
### *Push button actuation required for WALK*

At unfamiliar intersections, pedestrians who are blind have no way to know pedestrian actuation is required unless there is an APS with a locator tone. Therefore pedestrians who are blind are unlikely to use pushbuttons at unfamiliar intersections and are more likely to cross relying only on the cue of traffic surge, whether or not it corresponds to the onset of the walk interval. Even if the parallel traffic surge is interpreted correctly, the green phase timing may not be sufficient to allow a pedestrian to safely cross the street. The problem is compounded when the pushbutton is not right beside the probable location of a pedestrian who is waiting to cross; this may require pedestrians who are blind or visually impaired to repeatedly leave their chosen starting location and heading and push the button again, and then return to their chosen starting location and re-establish their heading.

### Non-concurrent WALK interval

Some signal timing plans at multi-leg intersections display the pedestrian WALK signal at a different time than the green phase for adjacent parallel traffic (Figure D-8). Pedestrians who are blind or visually impaired will typically assume that the WALK interval will begin with the onset of through traffic on the parallel street. Without an APS, they will not know the appropriate time to cross at such locations.

**Figure D-8.**  
Pedestrian crosswalk  
with non-concurrent  
WALK interval

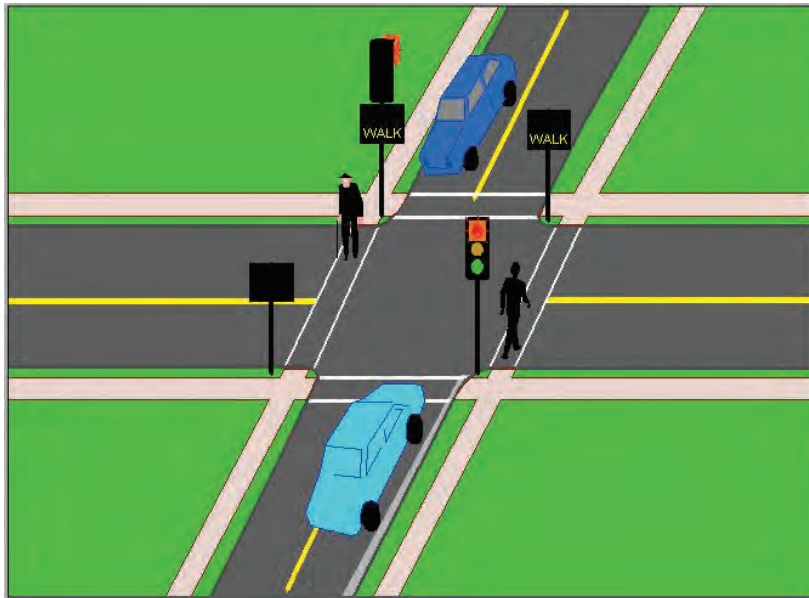


### Leading Pedestrian Interval — LPI (with parallel street green)

The LPI permits pedestrians parallel to a traffic stream to move prior to the vehicles receiving a green signal, with a goal of allowing pedestrians to “claim” the crosswalk space prior to vehicles that may be turning right (Figure D-9). Unfortunately, this treatment creates a scenario in which blind pedestrians are unable to detect the beginning of the walk interval if there is no audible indication. Subsequently, they may begin crossing only when the parallel traffic starts, which may be too late in the pedestrian phase and at a time when drivers are not expecting them.

### Timed for crossing to median island

On wide streets with medians or crossing islands, blind pedestrians cannot easily determine whether the WALK signal is intended to allow them to cross the entire street or only to the mid-point. Without an APS providing an audible cue at the median, blind pedestrians are unable to recognize that they must stop there, which may place them in a high-risk situation. The *MUTCD* states: “Where the pedestrian clearance time is sufficient only for crossing from the curb or shoulder to a median of sufficient width for pedestrians to wait, additional measures should be considered, such as median-mounted pedestrian signals or additional signing.” (*MUTCD* 2003)



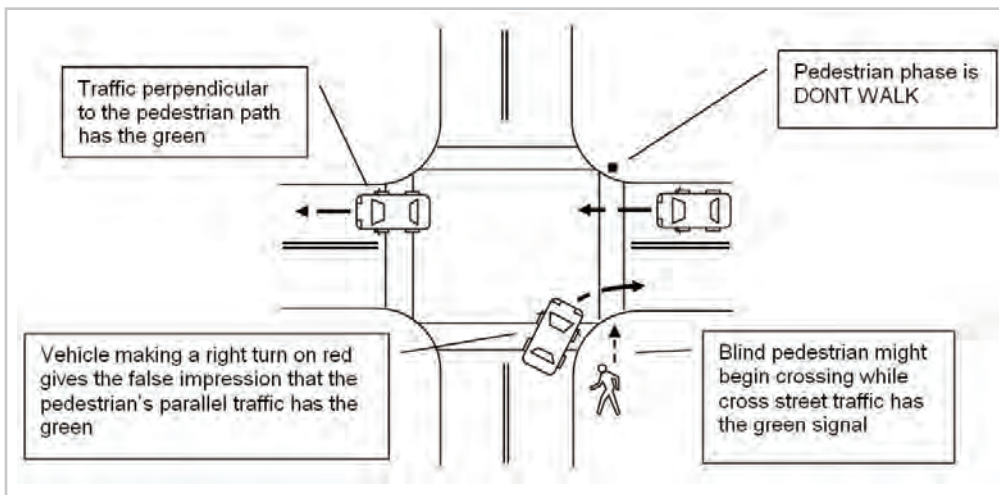
**Figure D-9.**  
**Leading Pedestrian**  
**Interval (source:**  
**Insurance Institute for**  
**Highway Safety)**

### *Vehicle Signal Control*

The types of signal phases available for vehicle traffic can greatly impact upon the ability of the pedestrian who is visually impaired to understand the audible cues from the traffic surges of various movements and make correct decisions about when it is appropriate to cross the street. Each type of signal phasing that may lead to this ambiguity is defined below.

### *Right-Turn-On-Red (RTOR) permitted (on parallel street)*

The allowance of RTOR on the parallel street may create a false audible cue for the blind pedestrian (Figure D-10). Vehicles turning right after stopping may be interpreted as indicating the onset of the parallel green phase, and pedestrians who are blind or visually impaired may begin to cross the street at the wrong time. RTOR vehicles also make it harder to audibly recognize the onset of the parallel traffic movement.



**Figure D-10.**  
**Right turns on red can**  
**mislead blind pedestrians**



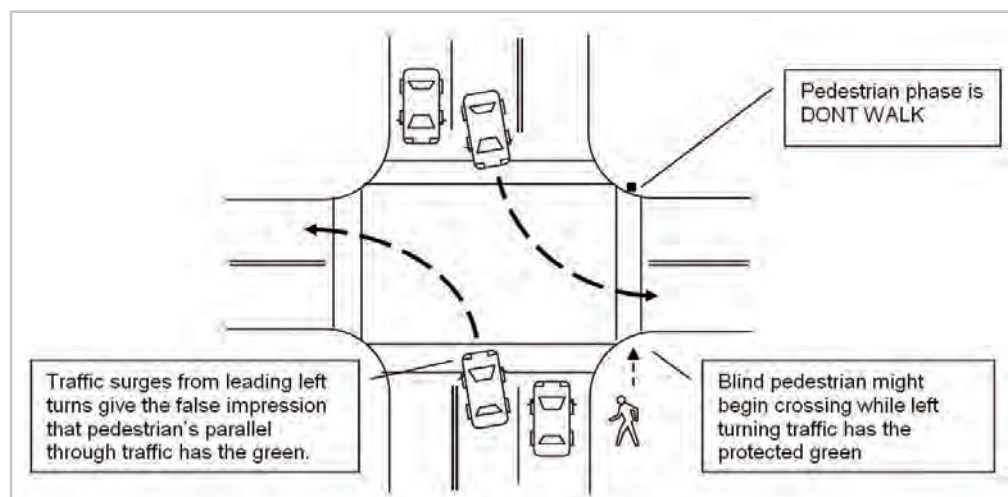
The allowance of RTOR during an exclusive pedestrian phase also sends mixed signals. If vehicles are turning, blind pedestrians may not be aware that they have a WALK interval. If they do recognize it, there may be a delayed initiation of crossing which means they may not begin crossing on the WALK interval and may still be in the street during the DONT WALK interval.

### *Leading protected left-turn phase (on parallel street)*

It can be difficult for a blind pedestrian to audibly distinguish between the surge of traffic at the beginning of a protected left-turn phase and the beginning of the through traffic phase (Figure D-11). The moving cars of the leading left-turn phase may also mask the sounds of the parallel through traffic beginning to move, particularly if the protected left-turn interval is followed by a permissive left-turn interval.

Note: Points are **not** given for lagging left-turn phases, which are much better for a blind pedestrian. With a lagging left-turn interval, the through traffic on the parallel street is the first vehicular maneuver after traffic stops on the cross street. The onset of the WALK interval usually occurs at the same time and allows all pedestrians, including blind pedestrians to initiate the crossing. The pedestrians are then typically clear of the intersection by the time the lagging left-turn interval begins.

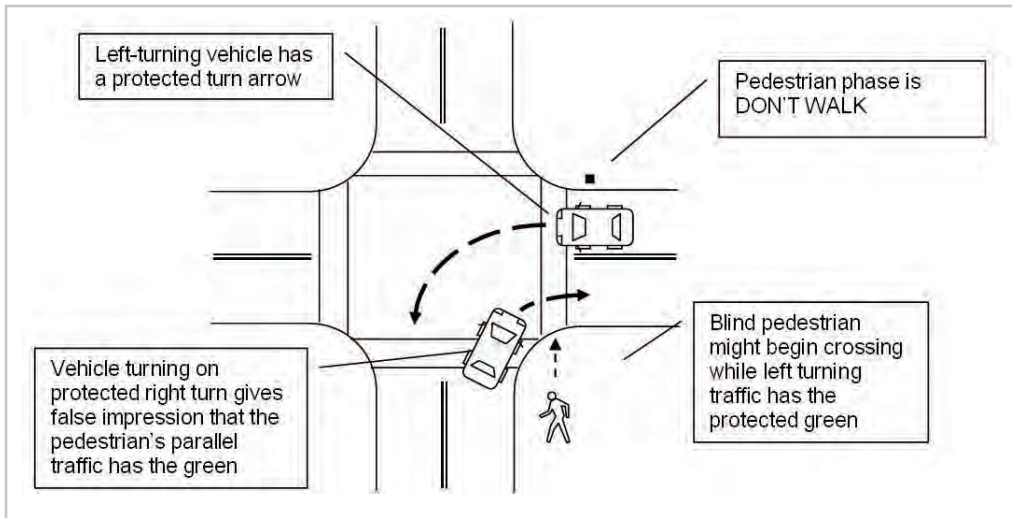
**Figure D-11.**  
Leading protected left turns can mislead blind pedestrians



### *Protected right-turn-only phase (on parallel street)*

The surge of traffic by right-turning vehicles using a protected right-turn phase may be incorrectly interpreted as the beginning of the parallel through traffic surge and the simultaneous onset of the WALK interval (Figure D-12).

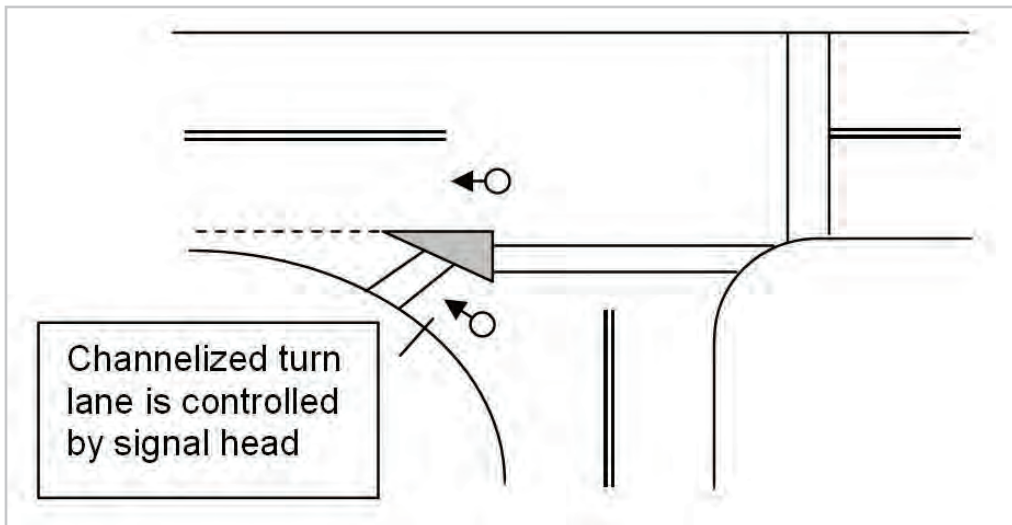
### *Channelized right-turn lane under signal control*



**Figure D-12.**  
Protected right turn phase can mislead blind pedestrians

Turning vehicles at channelized turns are typically under yield control. They must stop only if there is traffic approaching intersection the cross street, or if a pedestrian is in the crosswalk. However, at some channelized right-turn lanes, vehicles are controlled by a signal that prohibits turns if the signal is red (Figure D-13). Without an audible indication, a blind pedestrian will not know that traffic at the channelized turn lane is under signal control and may attempt to cross when the traffic has a green signal. This confusion of priorities may lead to an unsafe crossing.

**Note:** The point values for this factor are for the “signalization” component only. A channelized right-turn lane that is signalized will also receive points under “Channelized right turn island”.



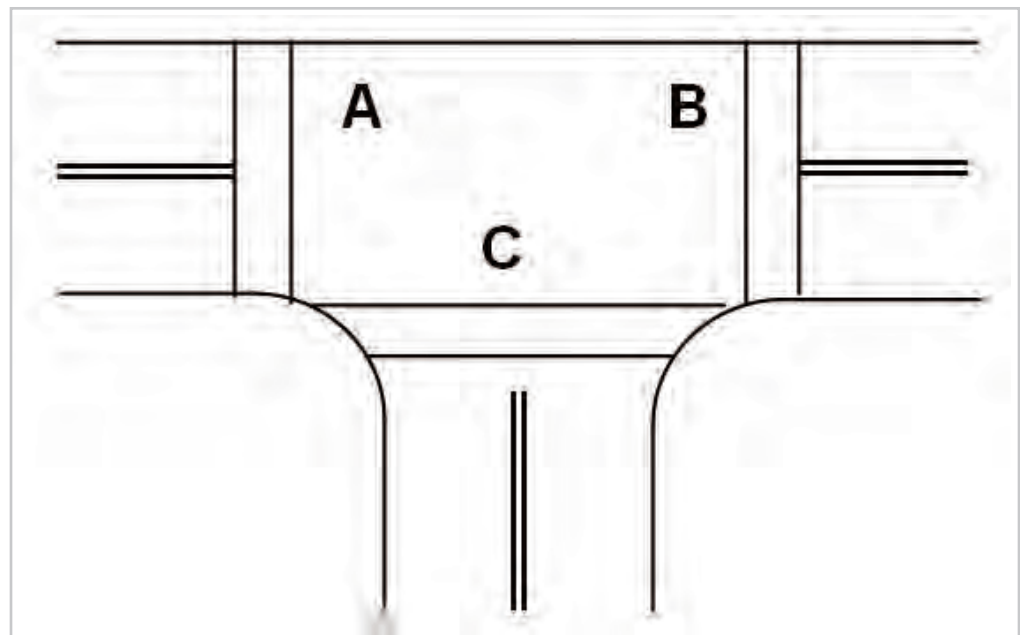
**Figure D-13.**  
Channelized turn lane under signal control

## OFF-PEAK TRAFFIC PRESENCE

Traffic flow that is very light or erratic (which most often occurs in off-peak periods) makes it difficult to use traffic sound to recognize signal changes. In such cases, audible signals can help to determine the onset of the walk interval. While many municipalities may have turning movement counts or average daily traffic counts, it is not a simple or uniform process to translate these numbers into a meaningful measure for assessing off-peak traffic presence. Instead, this variable is scored on the basis of the proportion of time that at least two vehicles are present at the beginning of a green phase in through lanes that are parallel to the path of the pedestrian.

Note that traffic presence in this category refers to traffic that is parallel to the crosswalk and passes straight through the intersection. If there is no through traffic at the intersection (no lanes continuing straight), there is no reliable traffic available for the blind pedestrian to use as a cue that the walk interval has begun, and the crosswalk would get a rating of “None” and receive the maximum number of points. An example of such a configuration is a T-intersection (Figure D-14).

**Figure D-14.**  
Crosswalks A and B, across top of the T, at a T-intersection, have no parallel through traffic. In contrast, Crosswalk C has parallel through traffic.



Noting the number of signal cycles with 2 or more through vehicles over 5 to 10 cycles during the off-peak should be sufficient for determining the percentage for scoring this variable. The levels provided on the worksheet reflect the results that may be acquired in such an exercise.

## DISTANCE TO ALTERNATIVE APS CROSSING

If there is another signalized crosswalk with APS in close proximity to the intersection being rated, the intersection should receive a lower score (lower priority for APS) than a similar intersection where there is no nearby crossing alternative.

If an alternative accessible crossing is present and scored as such, care must be taken to ensure that the alternative crossing meets the need of the blind traveler by getting them to/from the destination. Just because a crossing is close, it may not always be in a location that helps get the person to their destination. A local Orientation & Mobility Specialist or a pedestrian who has requested an APS can assist with making this determination.

## **PEDESTRIAN PUSHBUTTON LOCATION (EITHER CORNER)**

Section 4E.09 of the MUTCD provides guidance on where pedestrian pushbuttons with APS should be located as follows:

- a) Adjacent to a level all-weather surface to provide access from a wheelchair, and where there is an all-weather surface, wheelchair accessible route to the ramp;
- b) Within 1.5 m (5 ft) of the crosswalk extended;
- c) Within 3 m (10 ft) of the edge of the curb, shoulder, or pavement; and
- d) Parallel to the crosswalk to be used. (MUTCD 2003)

The Crosswalk Worksheet provides for points to be added if the location of pedestrian push buttons on either side of a crosswalk does not meet either B or C above. In essence, this variable will give an intersection with poorly located pushbuttons a higher priority for the installation of APS over an intersection with properly located pushbuttons (assuming all other characteristics of the two intersections are the same). Poorly located pushbuttons create much greater difficulty for blind pedestrians in terms of being easily accessible, being positioned in a manner to provide alignment cues, and being located close enough to the curb to be pushed and then cross on the same cycle.

## **REQUESTS FOR APS**

Requests for an APS may come from a pedestrian who is visually impaired or from an Orientation and Mobility professional. These requests are usually very specific – the individual needs to travel from their home to their workplace and needs to cross this street using this crosswalk. Such requests should increase the priority for APS.

## Blank Prioritization Tool Worksheets

On the following pages are blank forms that may be reproduced for use in the field when evaluating intersections and crosswalks. There are three separate forms to be used at all intersections—an *Intersection Worksheet*, *Crosswalk Worksheet*, and *Supplemental Form*—as well as a cover sheet for easy reference of the crosswalk scores.

<b>Prioritization Tool for Installation of Accessible Pedestrian Signals</b> <i>Cover Sheet</i>	
Location:	
Evaluator:	
Evaluation Date:	

<b>Evaluation Summary</b>
Enter total crosswalk score or N/A
Crosswalk A Total Score:
Crosswalk B Total Score:
Crosswalk C Total Score:
Crosswalk D Total Score:
Crosswalk E Total Score:
Crosswalk F Total Score:
Crosswalk G Total Score:
Crosswalk H Total Score:

For each crosswalk, the total score is the intersection score added to the score from the individual crosswalk worksheet.

***Draft Version***

National Cooperative Highway Research Program  
*Project 3-62: Guidelines for Accessible Pedestrian Signals*

**2006**

**Figure D-15. Cover Sheet of APS Prioritization Tool**


Prioritization Tool for Installation of Accessible Pedestrian Signals, IICHRP 3-62, 2006 <b>Intersection Worksheet</b>				
<b>Location:</b>				
<p><b>Sketch:</b> See instructions for information to include. Label crosswalks as A, B, C, D, etc.</p> <div style="text-align: center;">  <p>Indicate North</p> </div>	<b>Configuration (select one)</b>		Points	Score
	4-leg		0	
	4-leg offset		3	
	3-leg (T or Y)		3	
	5 or more legs		12	
	Midblock location		14	
	<b>Signalization* (select one)</b>		Points	Score
	Pre-timed		0	
	Actuated (semi or fully)		2	
	Split phasing		6	
Exclusive ped phase		8		
<b>Transit Facilities within a block (~ 1/8 mile) of the intersection - all legs (select one)</b>		Points	Score	
No transit facilities		0		
Single bus route		1		
Multiple bus routes		3		
Transit mall/rail station		5		
<b>Distance to Facility for Visually Impaired (select one)</b>		Points	Score	
> 2600 ft (~1/2 mile)		0		
< 2600 ft (~1/2 mile)		4		
< 1900 ft (~1/4 mile)		6		
< 650 ft (~1/8 mile)		8		
< 300 ft		10		
<b>Other Intersection Level Issues</b>				
<b>Distance to Major Pedestrian Attraction (select one)</b>		Points	Score	
> 2600 ft (~1/2 mile)		0		
< 2600 ft (~1/2 mile)		2		
< 1900 ft (~1/4 mile)		3		
< 650 ft (~1/8 mile)		4		
< 300 ft		5		
<p>** Select the option with the highest point value that applies to the situation.</p>				
<p>** The accompanying instructions are essential for accurate completion of this form **</p>		<p><b>Intersection Worksheet Score:</b> <input style="width: 50px; height: 20px;" type="text"/></p> <p>(sum of scores on this page)</p>		

Figure D-16. Intersection Worksheet of APS Prioritization Tool

<b>Prioritization Tool for Installation of Accessible Pedestrian Signals, HCHRP 3-62, 2006</b> <b>Crosswalk Worksheet</b> (Complete one sheet for each crosswalk)							
<b>Location:</b>			<b>Crosswalk Label:</b>				
<b>Crosswalk Width (select one)</b>		<b>Points</b>	<b>Score</b>	<b>Posted Speed Limit (select one)</b>			
< 40 ft		0		< 20 mph			
40 - 59 ft		1		25 mph			
60 - 79 ft		2		30 mph			
80 - 99 ft		3		35 mph			
100 - 119 ft		4		40 mph			
≥ 120 ft		5		≥ 45 mph			
<b>Approach/Crosswalk Geometrics (select all that apply)</b>				<b>Points</b>	<b>Score</b>		
Curb radius > 25 ft (either corner)				1			
Islands or medians (painted, raised or cut-through)				1			
Transverse (cross) slope on crosswalk				1			
Apex (diagonal) curb ramp (either corner)				2			
Channelized right turn island				2			
Skewed crosswalk				7			
<b>Pedestrian Signal Control (select all that apply)</b>				<b>Points</b>	<b>Score</b>		
Push button actuation required for WALK signal				4			
Non-concurrent WALK interval				4			
Leading Pedestrian Interval (LPI) with parallel street green				8			
Timed for crossing to median island				8			
<b>Vehicle Signal Control (select all that apply)</b>				<b>Points</b>	<b>Score</b>		
Right-Turn-On-Red permitted (on parallel street)				2			
Leading protected left-turn phase (on parallel street)				3			
Protected right turn phase / right turn overlap (on parallel street)				7			
Channelized right turn lane under signal control				8			
<b>Off-Peak Traffic Presence - at least 2 vehicles present on parallel street (select one)</b>				<b>Points</b>	<b>Score</b>		
Constant (≥ 90 percent of ten cycles)				1			
Heavy (70 - 80 percent)				2			
Moderate (50 - 60 percent)				3			
Light (30 - 40 percent)				4			
Occasional (< 30 percent)				5			
None (i.e., no through lanes present to create surge noise - e.g., stem of T-intersection)				6			
<b>Distance to Alternative APS Crosswalk (select one)</b>		<b>Points</b>	<b>Score</b>	<b>Pedestrian Pushbutton Location - either corner (select all that apply)</b>			
< 300 ft		0		Located > 10 ft from curb			
< 650 ft (~ 1/8 mile)		1		Located > 5 ft from the CW extd.			
< 1300 ft (~ 1/4 mile)		2					
< 2600 ft (~ 1/2 mile)		3					
≥ 2600 ft (~ 1/2 mile)		4					
<b>Other Crosswalk Level Issues</b>				<b>Requests for APS (select one)</b>			
** The accompanying instructions are essential for accurate completion of this form **				No requests		0	
				1 or more requests		6	
				<b>Crosswalk Worksheet Score:</b> (score from this page)			
				<b>Intersection Worksheet Score:</b> (score from intersection form)			
				<b>Total Crosswalk Score:</b> (add the two above scores)			

Figure D-17. Crosswalk Worksheet of APS Prioritization Tool



Prioritization Tool for Installation of Accessible Pedestrian Signals, IICHRP 3-62, 2006	
<b>Supplemental Worksheet</b>	
Location:	
Supplemental Sketch	
Supplemental Notes	

**Figure D-18. Supplemental Worksheet of APS Prioritization Tool**

## Examples of Completed Prioritization Tool Worksheets

The following two examples show how the Prioritization Tool would be used to rate two crosswalks. The first example is a crosswalk that would be relatively easier for pedestrians who are blind or visually impaired. The second example is a crosswalk that would be relatively difficult.

### EXAMPLE CROSSWALK #1

This example uses the APS Prioritization Tool to rate a crosswalk at an intersection in a dense urban area. Both streets of the intersection are fairly narrow and have 35 mph speed limits. The signal is pretimed. Figure 5-1 shows an overhead view of the intersection, with the crosswalk of interest outlined.



**Figure D-19.**  
**Overhead view of**  
**Example Crosswalk #1**  
**(Google Earth © 2005)**

The first worksheet deals with the intersection characteristics (Figure D-20). The total intersection score was zero, since the intersection was a simple 4-legged configuration with a pretimed signal and was not located near transit facilities, facilities for the visually impaired, or major pedestrian attractions.

**Figure D-20.**  
**Intersection Worksheet for**  
**Example Crosswalk #1**

Prioritization Tool for Installation of Accessible Pedestrian Signals, NCHRP 3-62, 2006				
<b>Intersection Worksheet</b>				
<b>Location:</b> <i>Broadway &amp; Prospect</i>				
<b>Sketch:</b> See instructions for information to include. Label crosswalks as A, B, C, D, etc.		<b>Configuration (select one)</b>		
		4-leg	0	0
		4-leg offset	3	
		3-leg (T or Y)	3	
		5 or more legs	12	
		Midblock location	14	
		<b>Signalization* (select one)**</b>		
		Pre-timed	0	0
		Actuated (semi or fully)	2	
		Split phasing	6	
		Exclusive ped phase	8	
		<b>Transit Facilities within a block (- 1/8 mile) of the intersection - all legs (select one)</b>		
		No transit facilities	0	0
		Single bus route	1	
		Multiple bus routes	3	
		Transit mall/rail station	5	
		<b>Distance to Facility for Visually Impaired (select one)</b>		
		> 2600 ft (~1/2 mile)	0	0
		< 2600 ft (~1/2 mile)	4	
		< 1300 ft (~1/4 mile)	6	
		< 650 ft (~1/8 mile)	8	
		< 300 ft	10	
<b>Other Intersection Level Issues</b>				
		<b>Distance to Major Pedestrian Attraction (select one)</b>		
		> 2600 ft (~1/2 mile)	0	0
		< 2600 ft (~1/2 mile)	2	
		< 1300 ft (~1/4 mile)	3	
		< 650 ft (~1/8 mile)	4	
		< 300 ft	5	
<p>* For intersections only. Signalized midblock locations are accounted for under Configuration.</p> <p>** Select the option with the highest point value that applies to the situation.</p>				
<p>** The accompanying instructions are essential for accurate completion of this form **</p>			<p><b>Intersection Worksheet Score:</b> <i>0</i>                      (sum of scores on this page)</p>	

The second worksheet deals with the crosswalk (Figure D-21). Points were given for the following reasons:

- The crosswalk width is 50 feet. The worksheet range of 40-59 feet earns one point.
- The posted speed limit on Prospect (the street being crossed) is 35 mph. This earns three points.
- The traffic on Broadway (the parallel street) is constant, thereby giving constant audible cues for the pedestrian. This variable earns only one point.
- There is another APS-equipped crosswalk within one-quarter mile. Thus, the crosswalk being rated earns 2 points in this category.

There are no characteristics of this crosswalk that would qualify under the sections for “Approach/Crosswalk Geometrics,” “Pedestrian Signal Control,” or “Vehicle Signal Control.” In addition, the pushbutton poles are located close to the curb and within the crosswalk lines extended and there have been no requests for APS at this crosswalk; both receive zero points on the prioritization scheme.

Prioritization Tool for Installation of Accessible Pedestrian Signals, NCHRP 3-62, 2006					
<b>Crosswalk Worksheet</b>					
<i>(Complete one sheet for each crosswalk)</i>					
Location: <i>Broadway &amp; Prospect</i>			Crosswalk Label: <i>A</i>		
<b>Crosswalk Width (select one)</b>	Points	Score	<b>Posted Speed Limit (select one)</b>	Points	Score
< 40 ft	0		< 20 mph	0	
40 - 59 ft	1	<i>1</i>	25 mph	1	
60 - 79 ft	2		30 mph	2	
80 - 99 ft	3		35 mph	3	<i>3</i>
100- 119 ft	4		40 mph	4	
≥ 120 ft	5		> 45 mph	5	
<b>Approach/Crosswalk Geometrics (select all that apply)</b>			Points	Score	
Curb radius > 25 ft (either corner)			1		
Islands or medians (painted, raised or cut-through)			1		
Transverse (cross) slope on crosswalk			1		
Apex (diagonal) curb ramp (either corner)			2		
Channelized right turn island			2		
Skewed crosswalk			7		
<b>Pedestrian Signal Control (select all that apply)</b>			Points	Score	
Push button actuation required for WALK signal			4		
Non-concurrent WALK interval			4		
Leading Pedestrian Interval (LPI) with parallel street green			8		
Timed for crossing to median island			8		
<b>Vehicle Signal Control (select all that apply)</b>			Points	Score	
Right-Turn-On-Red permitted (on parallel street)			2		
Leading protected left-turn phase (on parallel street)			3		
Protected right turn phase / right turn overlap (on parallel street)			7		
Channelized right turn lane under signal control			8		
<b>Off-Peak Traffic Presence - at least 2 vehicles present on parallel street (select one)</b>			Points	Score	
Constant (≥ 90 percent of ten cycles)			1	<i>1</i>	
Heavy (70 - 80 percent)			2		
Moderate (50 - 60 percent)			3		
Light (30 - 40 percent)			4		
Occasional (< 30 percent)			5		
None (i.e., no through lanes present to create surge noise - e.g., stem of T-intersection)			6		
<b>Distance to Alternative APS Crosswalk (select one)</b>		Points	Score	<b>Pedestrian Pushbutton Location - either corner (select all that apply)</b>	
< 300 ft		0		Located > 10 ft from curb	
< 650 ft (~ 1/8 mile)		1		Located > 5 ft from the CW extd.	
< 1300 ft (~ 1/4 mile)		2	<i>2</i>		
< 2600 ft (~ 1/2 mile)		3			
≥ 2600 ft (~ 1/2 mile)		4			
<b>Other Crosswalk Level Issues</b>			<b>Requests for APS (select one)</b>		
			No requests		
			1 or more requests		
			Points		
			Score		
			0		
			6		
			<b>Crosswalk Worksheet Score:</b>		
			(score from this page)		
			<i>7</i>		
			<b>Intersection Worksheet Score:</b>		
			(score from intersection form)		
			<i>0</i>		
			<b>Total Crosswalk Score:</b>		
			(add the two above scores)		
			<i>7</i>		
<b>** The accompanying instructions are essential for accurate completion of this form **</b>					

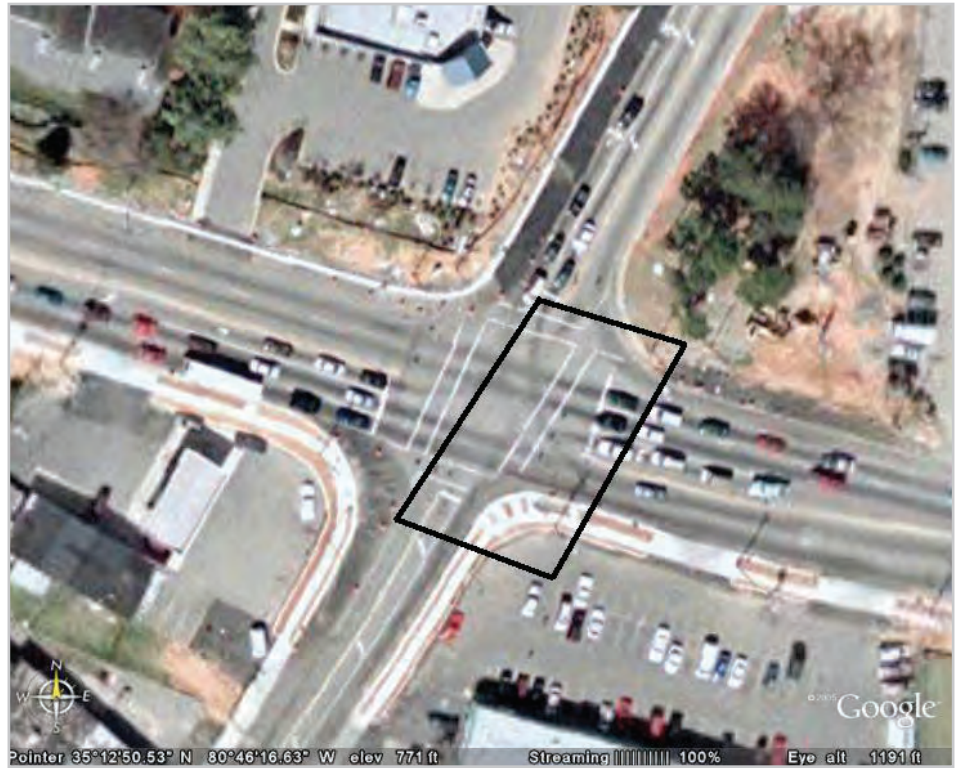
Figure D-21. Crosswalk Worksheet for Example Crosswalk #1

The crosswalk worksheet score is 7 points. When added to the intersection score of zero points, this yields a total crosswalk score of 7 points. In practice, this score of 7 points would be compared to other crosswalks under consideration for APS installations. Those crosswalks with the highest scores would have the highest priority for APS.

### EXAMPLE CROSSWALK #2

This example rates a crosswalk at a large intersection of a major arterial and a minor side street. The crosswalk of interest is on the east leg (highlighted in Figure D-22; shown at street level in Figure D-23).

**Figure D-22.**  
**Overhead view of**  
**Example Crosswalk #2**  
**(Google Earth © 2005)**



**Figure D-23.**  
**Street view of Example**  
**Crosswalk #2**



The first worksheet deals with the intersection characteristics (Figure D-24). Points were given for the following reasons:

- The signal is actuated but also uses split phasing, which is a higher point value than actuation, so the intersection gets the six points for split phasing. Split phasing is a less commonly used signal design, and the typically heavy turning movements make it harder to effectively use the traffic movement cue to determine signal changes. APS would provide a definitive cue to the onset of the WALK interval for pedestrians who are unable to see the pedestrian signal.
- There is a single bus route on the main street, which earns another point. The presence of public transit increases the likelihood that visually impaired pedestrians will travel at this intersection, thereby increasing the priority for APS.

There are no facilities specifically providing services for individuals who are visually impaired or major pedestrian attractors within one-half mile, so no points are given for those categories. The total intersection score is seven points.

Intersection Prioritization Tool for Installation of Accessible Pedestrian Signals, NCHRP 3-62, 2006																					
Intersection Worksheet																					
Location: <b>CENTRAL &amp; KILBOURNE/NORLAND</b>																					
Sketch: See instructions for information to include. Label crosswalks as A, B, C, D, etc.		<table border="1"> <thead> <tr> <th>Configuration (select one)</th> <th>Points</th> <th>Score</th> </tr> </thead> <tbody> <tr><td>4-leg</td><td>0</td><td>0</td></tr> <tr><td>4-leg offset</td><td>3</td><td></td></tr> <tr><td>3-leg (T or Y)</td><td>3</td><td></td></tr> <tr><td>5 or more legs</td><td>12</td><td></td></tr> <tr><td>Midblock location</td><td>14</td><td></td></tr> </tbody> </table>		Configuration (select one)	Points	Score	4-leg	0	0	4-leg offset	3		3-leg (T or Y)	3		5 or more legs	12		Midblock location	14	
Configuration (select one)	Points	Score																			
4-leg	0	0																			
4-leg offset	3																				
3-leg (T or Y)	3																				
5 or more legs	12																				
Midblock location	14																				
		<table border="1"> <thead> <tr> <th>Signalization* (select one)**</th> <th>Points</th> <th>Score</th> </tr> </thead> <tbody> <tr><td>Pre-timed</td><td>0</td><td></td></tr> <tr><td>Actuated (semi or fully)</td><td>2</td><td></td></tr> <tr><td>Split phasing</td><td>6</td><td>6</td></tr> <tr><td>Exclusive ped phase</td><td>8</td><td></td></tr> </tbody> </table>		Signalization* (select one)**	Points	Score	Pre-timed	0		Actuated (semi or fully)	2		Split phasing	6	6	Exclusive ped phase	8				
		Signalization* (select one)**	Points	Score																	
Pre-timed	0																				
Actuated (semi or fully)	2																				
Split phasing	6	6																			
Exclusive ped phase	8																				
Other Intersection Level Issues Split phasing		<table border="1"> <thead> <tr> <th>Transit Facilities within a block (~ 1/8 mile) of the intersection - all legs (select one)</th> <th>Points</th> <th>Score</th> </tr> </thead> <tbody> <tr><td>No transit facilities</td><td>0</td><td></td></tr> <tr><td>Single bus route</td><td>1</td><td>1</td></tr> <tr><td>Multiple bus routes</td><td>3</td><td></td></tr> <tr><td>Transit mall/rail station</td><td>5</td><td></td></tr> </tbody> </table>		Transit Facilities within a block (~ 1/8 mile) of the intersection - all legs (select one)	Points	Score	No transit facilities	0		Single bus route	1	1	Multiple bus routes	3		Transit mall/rail station	5				
		Transit Facilities within a block (~ 1/8 mile) of the intersection - all legs (select one)	Points	Score																	
No transit facilities	0																				
Single bus route	1	1																			
Multiple bus routes	3																				
Transit mall/rail station	5																				
		<table border="1"> <thead> <tr> <th>Distance to Facility for Visually Impaired (select one)</th> <th>Points</th> <th>Score</th> </tr> </thead> <tbody> <tr><td>&gt; 2600 ft (~1/2 mile)</td><td>0</td><td>0</td></tr> <tr><td>&lt; 2600 ft (~1/2 mile)</td><td>4</td><td></td></tr> <tr><td>&lt; 1300 ft (~1/4 mile)</td><td>6</td><td></td></tr> <tr><td>&lt; 650 ft (~1/8 mile)</td><td>8</td><td></td></tr> <tr><td>&lt; 300 ft</td><td>10</td><td></td></tr> </tbody> </table>		Distance to Facility for Visually Impaired (select one)	Points	Score	> 2600 ft (~1/2 mile)	0	0	< 2600 ft (~1/2 mile)	4		< 1300 ft (~1/4 mile)	6		< 650 ft (~1/8 mile)	8		< 300 ft	10	
		Distance to Facility for Visually Impaired (select one)	Points	Score																	
> 2600 ft (~1/2 mile)	0	0																			
< 2600 ft (~1/2 mile)	4																				
< 1300 ft (~1/4 mile)	6																				
< 650 ft (~1/8 mile)	8																				
< 300 ft	10																				
		<table border="1"> <thead> <tr> <th>Distance to Major Pedestrian Attraction (select one)</th> <th>Points</th> <th>Score</th> </tr> </thead> <tbody> <tr><td>&gt; 2600 ft (~1/2 mile)</td><td>0</td><td>0</td></tr> <tr><td>&lt; 2600 ft (~1/2 mile)</td><td>2</td><td></td></tr> <tr><td>&lt; 1300 ft (~1/4 mile)</td><td>3</td><td></td></tr> <tr><td>&lt; 650 ft (~1/8 mile)</td><td>4</td><td></td></tr> <tr><td>&lt; 300 ft</td><td>5</td><td></td></tr> </tbody> </table>		Distance to Major Pedestrian Attraction (select one)	Points	Score	> 2600 ft (~1/2 mile)	0	0	< 2600 ft (~1/2 mile)	2		< 1300 ft (~1/4 mile)	3		< 650 ft (~1/8 mile)	4		< 300 ft	5	
		Distance to Major Pedestrian Attraction (select one)	Points	Score																	
> 2600 ft (~1/2 mile)	0	0																			
< 2600 ft (~1/2 mile)	2																				
< 1300 ft (~1/4 mile)	3																				
< 650 ft (~1/8 mile)	4																				
< 300 ft	5																				
		* For intersections only. Signalized midblock locations are accounted for under Configuration. ** Select the option with the highest point value that applies to the situation.																			
		Intersection Worksheet Score: <b>7</b> (sum of scores on this page)																			

Figure D-24. Intersection Worksheet for Example Crosswalk #2

The second worksheet deals with the crosswalk (Figure D-25). Points were given for the following reasons:

- The crosswalk width of 110 feet and speed limit of 45 mph on the main street earn the crosswalk four and five points, respectively. Wider crosswalks and faster traffic increase the crossing difficulty and risk to visually impaired pedestrians, and APS may help expedite their crossing.
- The curb radius on one of the corners bordering the crosswalk is greater than 25 feet, so one point is given in the geometrics category. Larger curb radii create orientation problems for visually impaired pedestrians that may be decreased with the use of an APS.
- The signal requires push button actuation for the pedestrian WALK signal, so four points are given for the pedestrian signalization category. An APS locator tone would help a pedestrian who is visually impaired recognize that there is a pushbutton at that crosswalk and help in locating the pushbutton.
- Right-turn-on-red (RTOR) is permitted at the crosswalk, so two points are given in the vehicle signal control category. RTOR may produce misleading traffic cues, and an APS would provide a definitive cue of the appropriate time to cross.
- During off-peak hours, there was enough parallel traffic to provide audible cues (2 or more vehicles per cycle) about 75% of the time. This earns two points.
- There is not an alternative APS crosswalk within one-half mile, so four points are given towards the prioritization of an APS installation at this crosswalk.
- The pedestrian push button at one end of the crosswalk is located more than 10 feet from the curb, which is contrary to the recommendations in Section 4E.09 of the MUTCD. Three points are given for this drawback, since a correctly installed APS would position the push button closer to the curb which facilitates orientation alignment for blind and visually impaired pedestrians.

The crosswalk worksheet score is 25 points. When added to the intersection score of seven points, this yields a total crosswalk score of 32 points. In practice, this score of 32 points would be compared to other crosswalks under consideration for APS installations. Those crosswalks with the highest scores would have the highest priority for APS.





## References

*Manual on Uniform Traffic Control Devices, 2003 Edition*, (with Revision No. 1 incorporated), Federal Highway Administration, Washington, DC, November 2004.

# Appendix E:

## Glossary

In the following list, *MUTCD* refers to definitions taken from Section 4A.02 Definitions Relating to Highway Traffic Signals of the Manual on Uniform Traffic Control Devices.

### **Accessible pedestrian signal**

**(APS).** A device that communicates information about pedestrian timing in nonvisual format such as audible tones, verbal messages, and/or vibrating surfaces. (*MUTCD*)

**Actuated operation.** A type of traffic control signal operation in which some or all signal phases are operated on the basis of actuation. (*MUTCD*)

**Actuation.** Initiation of a change in or extension of a traffic signal phase through the operation of any type of detector. (*MUTCD*)

**Actuation indicator.** Either a light, a tone, a voice message, or both audible and visual indicators that indicate to pedestrians that the button press has been accepted.

### **Alert tone at onset of WALK interval.**

A very brief burst of high frequency sound, rapidly decaying to a 500 Hz WALK tone, to alert pedestrians to the exact onset of the WALK interval.

**APS.** See Accessible pedestrian signal.

**Audible beacon.** Use of a sound source to provide directional orientation and alignment information.

**Automatic volume adjustment.** An APS volume control that is automatically responsive to ambient (background) sound; automatic gain control.

**Braille street name.** Provision of the name of the associated street in Braille above the APS pushbutton.

**Button actuated timer (BAT).** See Extended button press.

**Clearance interval indicator.** Tones sounding during the pedestrian clearance interval that are differentiated from the WALK interval indicator (tones).

**Controller unit.** That part of a controller assembly that is devoted to the selection and timing of the display of signal indications. (*MUTCD*)

**Crosswalk.** (a) that part of a roadway at an intersection included within the connections of the lateral lines of the sidewalks on opposite sides of the highway measured from the curbs or in the absence of curbs, from the edges of the traversable roadway, and in the absence of a sidewalk on one side of the roadway, the part of a roadway included within the extension of the lateral lines of the sidewalk at right angles to the centerline; (b) any portion of a roadway at an intersection or elsewhere distinctly indicated for pedestrian crossing by lines or other markings on the surface. (*MUTCD*)

**Crosswalk map.** See Tactile map.

**Cycle Length.** The time required for one complete sequence of signal indications. (*MUTCD*)

**Detectable warning.** A standardized surface feature built in or applied to walking surfaces or other elements to warn visually impaired people of hazards on a circulation path.

**Detector.** A sensing device used for determining the presence or passage of vehicles or pedestrians. (*MUTCD*)

**Extended button press.** On APS, holding the ped button down between 1-3 sec. may activate special features, including audible beaconing and extended pedestrian clearance interval.

**Fixed time operation.** See Pretimed operation.

**Flashing (flashing mode).** A mode of operation in which a traffic signal indication is turned on and off repetitively. (*MUTCD*)

**Full-actuated operation.** A type of traffic control signal operation in which all signal phases function on the basis of actuation. (*MUTCD*)

**Intersection.** (a) the area embraced within the prolongation or connection of the lateral curb lines, or if none, the lateral boundary lines of the roadways of two highways that join one another at, or approximately at, right angles, or the area within which vehicles traveling on different highways that join at any other angle may come into conflict; (b) the junction of an alley or driveway with a roadway or highway shall not constitute an intersection. (*MUTCD*)

**Interval.** The part of a signal cycle during which signal indications do not change. (*MUTCD*)

**Interval sequence.** Interval sequence. The order of appearance of signal indications during successive intervals of a signal cycle. (*MUTCD*)

**Locator signal.** See Pushbutton locator tone.

**Long button press.** See Extended button press.

**Long cane.** A cane individually prescribed to provide safety and orientation information to persons who are blind or visually impaired; typically much longer than a support cane and not intended for support; typically has a white, reflective surface.

**Major street.** The street normally carrying the higher volume of vehicular traffic. (*MUTCD*)

**Minor street.** The street normally carrying the lower volume of vehicular traffic. (*MUTCD*)

**Passive pedestrian detection.** A feature that uses sensors (piezo-electric, infrared, microwave, or video camera serving remote sensor software) to trigger, cancel, or lengthen pedestrian timing, or to trigger the pushbutton locator tone when the pedestrian enters the detection zone.

**Pedestrian.** People who travel on foot or who use assistive devices, such as wheelchairs, for mobility.

**Pedestrian change interval.** An interval during which the flashing UPRAISED HAND (symbolizing DONT WALK) signal indication is displayed. When a verbal message is provided at an accessible pedestrian signal, the verbal message is “wait.” (*MUTCD*)

**Pedestrian clearance time.** The time provided for a pedestrian crossing in a crosswalk, after leaving the curb or shoulder, to travel to the center of the farthest traveled lane or to a median. (*MUTCD*)

**Pedestrian phase (or ped phase).**

The cycle of pedestrian timing consisting of three parts: (1) The WALK interval (WALK sign); (2) the pedestrian clearance interval (flashing DONT WALK); and the pedestrian change interval (steady DONT WALK).

**Pedestrian signal head.** A signal head, which contains the symbols WALKING PERSON (symbolizing WALK) and UPRAISED HAND (symbolizing DONT WALK), that is installed to direct pedestrian traffic at a traffic control signal. (*MUTCD*).

**Pedhead.** See Pedestrian signal head.

**Permissive mode.** A mode of traffic control signal operation in which, when a CIRCULAR GREEN signal indication is displayed, left or right turns may be made after yielding to pedestrians and/or oncoming traffic. (*MUTCD*)

**Preemption control.** The transfer of normal operation of a traffic control signal to a special control mode of operation. (*MUTCD*)

**Pretimed operation.** A type of traffic control signal operation in which none of the signal phases function on the basis of actuation. (*MUTCD*)

**Priority control.** A means by which the assignment of right-of-way is obtained or modified. (*MUTCD*)

**PROWAAC.** Public Rights of Way Access Advisory Committee of the U.S. Access Board, that includes advocates, engineers, architects, and public works officials.

**Protected mode.** A mode of traffic control signal operation in which left or right turns may be made when a

left or right GREEN ARROW signal indication is displayed. (*MUTCD*)

**Pushbutton.** A button to activate pedestrian timing. (*MUTCD*)

**Pushbutton locator tone.** A repeating sound that informs approaching pedestrians that they are required to push a button to actuate pedestrian timing and that enables pedestrians who have visual disabilities to locate the pushbutton. (*MUTCD*)

**Pushbutton message.** A speech message that provides additional information when the APS pedestrian pushbutton is pushed.

**Remote activation.** A handheld pushbutton device allowing a pedestrian to send a message over a short distance to call the ped phase.

**Semiactuated operation.** A type of traffic control signal operation in which at least one, but not all, signal phases function on the basis of actuation. (*MUTCD*)

**Signal head.** An assembly of one or more signal faces together with the associated signal housings. (*MUTCD*)

**Signal indication.** The illumination of a signal lens or equivalent device. (*MUTCD*)

**Signal phase.** The right-of-way, yellow change, and red clearance intervals in a cycle that are assigned to an independent traffic movement or combination of movements. (*MUTCD*)

**Signal section.** The assembly of a signal housing, signal lens, and light source with necessary components to be used for providing one signal indication. (*MUTCD*)

**Signal timing.** The amount of time allocated for the display of a signal indication. (*MUTCD*)

**Signal warrant.** A threshold condition that, if found to be satisfied as part of an engineering study, shall result in analysis of other traffic conditions or factors to determine whether a traffic control signal or other improvement is justified. (*MUTCD*)

**Steady (steady mode).** The continuous illumination of a signal indication for the duration of an interval, signal phase, or consecutive signal phases. (*MUTCD*)

**Tactile.** An object that can be perceived using the sense of touch.

**Tactile arrow (aligned in direction of travel).** A raised (tactile) arrow in an APS pushbutton that helps users know which crosswalk is actuated by the pushbutton.

**Tactile map.** A raised schematic map (located on an APS pushbutton housing) that shows what will be encountered as the pedestrian negotiates the crosswalk controlled by that push button.

**Traffic control signal (traffic signal).** Any highway traffic signal by which traffic is alternately directed to stop and permitted to proceed. (*MUTCD*)

**Vibrotactile pedestrian device.** A device that communicates, by touch, information about pedestrian timing using a vibrating surface. (*MUTCD*)

**WALK interval.** An interval during which the WALKING PERSON (symbolizing WALK) signal indication is displayed. When a verbal message is provided at an accessible pedestrian signal, the verbal message is “WALK sign.” (*MUTCD*)