

Evaluation of Bridge-Scour Research: Abutment and Contraction Scour Processes and Prediction

DETAILS

0 pages | | PAPERBACK

ISBN 978-0-309-43076-0 | DOI 10.17226/22841

AUTHORS

BUY THIS BOOK

FIND RELATED TITLES

Visit the National Academies Press at NAP.edu and login or register to get:

- Access to free PDF downloads of thousands of scientific reports
- 10% off the price of print titles
- Email or social media notifications of new titles related to your interests
- Special offers and discounts



Distribution, posting, or copying of this PDF is strictly prohibited without written permission of the National Academies Press. (Request Permission) Unless otherwise indicated, all materials in this PDF are copyrighted by the National Academy of Sciences.

Copyright © National Academy of Sciences. All rights reserved.

ACKNOWLEDGMENT

This work was sponsored by the American Association of State Highway and Transportation Officials (AASHTO), in cooperation with the Federal Highway Administration, and was conducted in the National Cooperative Highway Research Program (NCHRP), which is administered by the Transportation Research Board (TRB) of the National Academies.

COPYRIGHT INFORMATION

Authors herein are responsible for the authenticity of their materials and for obtaining written permissions from publishers or persons who own the copyright to any previously published or copyrighted material used herein.

Cooperative Research Programs (CRP) grants permission to reproduce material in this publication for classroom and not-for-profit purposes. Permission is given with the understanding that none of the material will be used to imply TRB, AASHTO, FAA, FHWA, FMCSA, FTA, Transit Development Corporation, or AOC endorsement of a particular product, method, or practice. It is expected that those reproducing the material in this document for educational and not-for-profit uses will give appropriate acknowledgment of the source of any reprinted or reproduced material. For other uses of the material, request permission from CRP.

DISCLAIMER

The opinions and conclusions expressed or implied in this report are those of the researchers who performed the research. They are not necessarily those of the Transportation Research Board, the National Research Council, or the program sponsors.

The information contained in this document was taken directly from the submission of the author(s). This material has not been edited by TRB.

THE NATIONAL ACADEMIES

Advisers to the Nation on Science, Engineering, and Medicine

The **National Academy of Sciences** is a private, nonprofit, self-perpetuating society of distinguished scholars engaged in scientific and engineering research, dedicated to the furtherance of science and technology and to their use for the general welfare. On the authority of the charter granted to it by the Congress in 1863, the Academy has a mandate that requires it to advise the federal government on scientific and technical matters. Dr. Ralph J. Cicerone is president of the National Academy of Sciences.

The **National Academy of Engineering** was established in 1964, under the charter of the National Academy of Sciences, as a parallel organization of outstanding engineers. It is autonomous in its administration and in the selection of its members, sharing with the National Academy of Sciences the responsibility for advising the federal government. The National Academy of Engineering also sponsors engineering programs aimed at meeting national needs, encourages education and research, and recognizes the superior achievements of engineers. Dr. Charles M. Vest is president of the National Academy of Engineering.

The **Institute of Medicine** was established in 1970 by the National Academy of Sciences to secure the services of eminent members of appropriate professions in the examination of policy matters pertaining to the health of the public. The Institute acts under the responsibility given to the National Academy of Sciences by its congressional charter to be an adviser to the federal government and, on its own initiative, to identify issues of medical care, research, and education. Dr. Harvey V. Fineberg is president of the Institute of Medicine.

The **National Research Council** was organized by the National Academy of Sciences in 1916 to associate the broad community of science and technology with the Academy's purposes of furthering knowledge and advising the federal government. Functioning in accordance with general policies determined by the Academy, the Council has become the principal operating agency of both the National Academy of Sciences and the National Academy of Engineering in providing services to the government, the public, and the scientific and engineering communities. The Council is administered jointly by both Academies and the Institute of Medicine. Dr. Ralph J. Cicerone and Dr. Charles M. Vest are chair and vice chair, respectively, of the National Research Council.

The **Transportation Research Board** is one of six major divisions of the National Research Council. The mission of the Transportation Research Board is to provide leadership in transportation innovation and progress through research and information exchange, conducted within a setting that is objective, interdisciplinary, and multimodal. The Board's varied activities annually engage about 7,000 engineers, scientists, and other transportation researchers and practitioners from the public and private sectors and academia, all of whom contribute their expertise in the public interest. The program is supported by state transportation departments, federal agencies including the component administrations of the U.S. Department of Transportation, and other organizations and individuals interested in the development of transportation. www.TRB.org

www.national-academies.org

CONTENTS

	<u>Page No.</u>
FIGURES.....	iii
TABLES.....	vi
SYMBOLS.....	vii
AUTHOR ACKNOWLEDGMENTS.....	ix
ABSTRACT.....	x
EXECUTIVE SUMMARY.....	1
CHAPTER 1. INTRODUCTION.....	9
1.1 Definitions.....	9
1.2 Motivation for Review.....	10
1.3 Objectives.....	14
1.4 Approach.....	14
CHAPTER 2. ABUTMENT FORM AND CONSTRUCTION.....	15
2.1 Abutment Form.....	15
2.2 Abutment Layout.....	16
2.3 Abutment Construction.....	17
2.4 Pier Proximity.....	19
2.5 Sediment and Soil Boundary Material.....	20
2.6 Flow Field.....	21
CHAPTER 3. ABUTMENT SCOUR AS A DESIGN CONCERN.....	25
3.1 Design Scour Depths.....	25
3.2 Estimation of Scour Depths.....	25
3.3 An Essential Design Question.....	26
CHAPTER 4. SCOUR CONDITIONS.....	28
4.1 Three Common Conditions of Abutment Scour.....	28
4.2 Influence of Pier Proximity.....	32
4.3 Other Scour Processes.....	32
CHAPTER 5. ABUTMENT SCOUR DEPTH ESTIMATION FORMULAS.....	34
5.1 Parameter Framework.....	34
5.2 Summary of Abutment Scour Formulas.....	37
5.3 Classification of Scour Formulas.....	42
5.4 Evaluation of Abutment Scour Formulas.....	48
5.5 Geotechnical Approach.....	58

CHAPTER 6. CONTRACTION SCOUR FORMULAS.....	60
6.1 Definition of Contraction Scour.....	60
6.2 Dimensional Analysis.....	60
6.3 Idealized Long-Contraction Scour.....	62
6.4 Contraction Scour Formulas from Laboratory Data.....	63
6.5 Field Data on Contraction Scour.....	64
6.6 Vertical Contraction Scour.....	65
 CHAPTER 7. RECOMMENDATIONS FOR DESIGN ESTIMATION OF ABUTMENT AND CONTRACTION SCOUR.....	 66
7.1 General Recommendations.....	66
7.2 Specific Recommendations.....	67
 CHAPTER 8. RESEARCH AND EDUCATION NEEDS.....	 70
8.1 Introduction.....	70
8.2 Scour Processes.....	70
8.3 Design Estimation of Scour.....	71
8.4 Monitoring and Maintenance.....	73
 CHAPTER 9. CONCLUSIONS.....	 75
 CHAPTER 10. REFERENCES.....	 78
 APPENDICES	
A. Abutment Scour Equations.....	83
B. Contraction Scour Equations.....	85
C. Research Problem Statements.....	87

FIGURES

<u>Caption</u>	<u>Page No.</u>
Figure 1-1. Schematic of long, multi-span bridge over a compound channel.....	11
Figure 1-2. Schematic of relatively short bridge over narrow main channel	11
Figure 1-3. Abutment scour resulting in embankment failure by collapse due to geotechnical instability.....	12
Figure 1-4. Scour at I-70 bridge over Missouri River from 1993 flood with flow from left to right. (Photo from Parola et al. 1998).....	13
Figure 2-1. Plan views of the two common abutment forms: (a) Wing-wall; (b) Spill-through (Ettema et al. 2010).....	15
Figure 2-2. Definitions of embankment length, floodplain width, and main channel width (Ettema et al. 2010).....	16
Figure 2-3. Isometric view of spill-through abutment comprising a standard-stub column located within the end of an earthfill embankment (Ettema et al. 2010).....	17
Figure 2-4. The geometry and dimensions of a standard-stub abutment commonly used for spill-through abutments (prototype scale indicated); design provided by the Iowa DOT (Ettema et al. 2010).....	18
Figure 2-5. The geometry and dimensions of a wing-wall abutment - compacted earthfill embankment extends back from the abutment structure (prototype scale indicated); design provided by the Iowa DOT (Ettema et al. 2010).....	18
Figure 2-6. A spill-through abutment with a pier in close proximity; approximate layout proportions of $L/B_f = 1.0$; $B_f/0.5B \approx 0.7$, and $L/W \approx 1.0$, in which W = embankment top width (Ettema et al. 2010).....	19
Figure 2-7. Variation of soil and sediment types at a bridge crossing (Ettema et al. 2010)....	20
Figure 2-8. Flow structure including macro-turbulence generated by flow around abutments in a narrow main channel. (Ettema et al. 2010).....	21
Figure 2-9. Flow structure including macro-turbulence generated by floodplain/main channel flow interaction, flow separation around abutment, and wake region on the floodplain of a compound channel. (Ettema et al. 2010).....	22

<u>Caption</u>	<u>Page No.</u>
Figure 2-10. Interaction of flow features causing scour and erodibility of boundary (Ettema et al. 2010).....	23
Figure 2-11. For a spill-through abutment well set back on a flood-plain, deepest scour usually occurs where flow is most contracted through the bridge waterway.....	24
Figure 3-1. A common situation of abutment failure; scour has led to failure and partial washout of the earthfill spill-slope at this abutment. A basic question arises as to how abutment design should take scour into account.....	27
Figure 3-2. Failure of abutment fill in September 2009 Georgia flood accompanied by failure of approach roadway (Hong and Sturm 2010).....	27
Figure 4-1. Abutment-scour conditions: Scour Condition A - hydraulic scour of the main channel bed causes bank failure, which causes a failure of the face of the abutment embankment (a); Scour Condition B - hydraulic scour of the floodplain causes failure of the face of the abutment embankment (b); and, Scour Condition C - breaching of the approach embankment exposes the abutment column so that scour progresses as if the abutment were a form of pier (c) (Ettema et al. 2010).....	29
Figure 4-2. Field example of Scour Condition A.....	31
Figure 4-3. Scour Condition B.....	31
Figure 4-4. Scour condition C for a wing-wall abutment.....	32
Figure 5-1. Definition sketch for abutment terminating in a compound channel.....	35
Figure 5-2. Bankline abutment in a narrow channel.....	45
Figure 5-3. Bridge crossing for a compound channel.....	45
Figure 5-4. Bridge crossing of a braided channel.....	46
Figure 5-5. Comparison between scour data at a spill-through abutment (with riprap protection extended below the surface of the floodplain) and the formula by Sturm and Chrisochoides 1998 (see also Sturm 2004, 2006). Reproduced from NCHRP Report 587 by Barkdoll et al. (2007).....	52
Figure 5-6. Comparison between scour data at a spill-through abutment (with riprap protection extended below the surface of the floodplain) and the formula by Melville (1997). Reproduced from NCHRP Report 587 by Barkdoll et al. (2007).....	52

<u>Caption</u>	<u>Page No.</u>
Figure 5-7. Comparison of Briaud et al. (2009) formula with experimental results of Ettema et al. (2010) for Scour Condition B. [Reproduced from Briaud et al. (2009). Final design curves are Figs. 12.3 and 12.4 of the NCHRP 24-20 report by Ettema et al. (2010)].	54
Figure 5-8. Comparison of Melville (1992, 1997) formula and Sturm (2004, 2006) data for rigid abutments with Ettema et al. (2010) data for erodible abutments and Scour Condition B.	55
Figure 5-9. Scour depth trends for Scour Condition B. (Ettema et al. 2010).	56
Figure 5-10. Minnesota River near Belle Plaine, MN for 2001 flood. (Wagner et al. 2006).	57
Figure 5-11. Scour depth estimation based on geotechnical stability of embankment; (a) variables, (b) failure of embankment past abutment column relieves flow so that maximum scour depth is attained (Ettema et al. 2010).	59
Figure 6-1. Definition sketch for idealized long contraction scour (Q_1 = main channel flowrate for live-bed scour; Q_2 = total flowrate in channel at contracted section; d_{sc} = contraction scour depth).	61

TABLES

<u>Caption</u>	<u>Page No.</u>
Table 5-1. Classification of abutment scour parameters.....	36
Table 5-2. Formulas categorized by parameter groups.....	43
Table 5-3. Limitations and experimental databases of abutment scour formula.....	50
Table 8-1. Prioritized list of research and education needs addressing improved understanding of abutment-scour processes.....	71
Table 8-2. List of design-related research tasks addressing improved design estimation of abutment scour depth coupled to research needs in Table 8-1.....	73
Table 8-3. Prioritized list of research and education needs addressing improved methods for monitoring and maintenance (needs I1, I2, and I3 can be combined).....	74
Table A-1. A selection of abutment scour equations (revised and extended from Melville and Coleman 2000).....	83
Table B-1. A selection of contraction scour formulas (B_1 = approach flow channel width; B_2 = contracted channel width; Y_1 = approach flow channel depth; Y_2 = contracted channel depth after scour).....	85

SYMBOLS

B = width of total flow cross section at the bridge crossing
 B_f = width of the floodplain
 B_{m1} = width of the main channel in the approach flow section
 B_{m2} = width of the main channel in the bridge section
 d_s = scour depth at the bridge section
 d = some measure of the sediment size such as the median size by weight, d_{50}
 F = flow Froude number
 F_c = critical flow Froude number when sediment motion begins
 F_d = densimetric grain Froude number = $V / [(\rho_s/\rho - 1)gd]^{1/2}$
 g = acceleration of gravity
 H_E = height of the embankment
 k_F = roughness height of the floodplain
 k_m = roughness height of the main channel
 K_s = shape factor of the abutment as it affects scour by the flow field
 K_θ = embankment skewness factor as it affects scour
 K_f = spiral flow factor in Maryland formula
 K_v = velocity adjustment factor in Maryland formula
 K_p = pressure flow coefficient in Maryland formula
 L = length of the abutment/embankment
 L_c = length of contraction transition
 m = geometric contraction ratio = $(B - 2L)/L$
 M = discharge contraction ratio = $(Q - Q_{obst})/Q$
 Q = total discharge going through the bridge
 Q_{obst} = discharge in the approach flow obstructed by the bridge embankment
 q_1 = discharge per unit width in approach flow cross section
 q_2 = discharge per unit width in contracted bridge section
 u_{*1} = shear velocity of the approach flow
 u_{*c} = critical value of shear velocity for initiation of sediment motion
 V_1 = approach flow velocity
 V_c = critical velocity for initiation of sediment motion
 W = width of the embankment in the flow direction
 Y_1 = upstream approach flow depth in main channel
 Y_2 = maximum depth of flow after scour at the bridge in main channel or floodplain
 Y_C = mean flow depth at the bridge due to contraction scour
 Y_F = upstream approach flow depth in the floodplain
 Y_{MAX} = maximum flow depth at the bridge after scour

Greek symbols

α = scour amplification factor
 ρ = density of the fluid
 ρ_s = sediment density
 μ = viscosity of the fluid, respectively
 σ_g = geometric standard deviation of grain size distribution
 σ = bulk shear strength of the embankment fill

γ_E = bulk density of the embankment

τ_1 = mean boundary shear stress in approach flow

τ_2 = mean boundary shear stress in contracted flow section

τ_c = critical shear stress for initiation of sediment motion

ACKNOWLEDGMENTS

The research reported herein was performed under NCHRP Project 24-27(02) by the Georgia Institute of Technology, School of Civil and Environmental Engineering, Atlanta, GA. Georgia Tech was the primary contractor for this study with subcontracts issued to the University of Wyoming, Laramie, WY and the University of Auckland, Auckland, New Zealand.

Dr. Terry W. Sturm, Ph.D., P.E. , Professor of Civil and Environmental Engineering, was the Project Director and Co-Principal Investigator. The other authors of this report are Dr. Robert Ettema, Ph.D., P.E., Professor and Dean, College of Engineering, University of Wyoming, and Dr. Bruce W. Melville, Professor, Department of Civil and Environmental Engineering, University of Auckland, both of whom were members of the research team serving as Co-Principal Investigators.

The research team is very grateful for the technical comments provided by an expert team of researchers and consultants: The expert team members were:

- Mr. David Andres, Northwest Hydraulic Consultants, Edmonton, Alberta
- Mr. Sterling Jones, formerly with the Federal Highway Administration, Turner-Fairbanks Hydraulic Laboratory, McLean, Virginia
- Dr. D. Max Sheppard, Ocean Engineering Associates, Gainesville, Florida
- Dr. Mutlu Sumer, Technical University of Denmark, Lyngby, Denmark
- Dr. Lyle Zevenbergen, Ayres Associates, Inc., Fort Collins, Colorado

Many useful suggestions, which are gratefully acknowledged by the research team, were provided by the NCHRP Panel for this project.

ABSTRACT

This report reviews the present state of knowledge regarding bridge-abutment scour and the veracity of the leading methods currently used for estimating design scour depth. It focuses on research information obtained since 1990, which is to be considered in updating the scour estimation methods that are recommended by AASHTO, and used generally by engineering practitioners. Though considerable further progress has been made since 1990, the findings indicate that several important aspects of abutment scour processes remain inadequately understood and therefore, are not included in current methods for scour depth estimation. The state-of-art for abutment scour estimation is considerably less advanced than for pier scour. Moreover, there is a need for design practice to consider how abutment design should best take scour into account, as scour typically results in the geotechnical failure of an abutment's earthfill embankment, possibly before a maximum potential scour depth is attained hydraulically. Abutment scour herein is taken to be scour at the bridge-opening end of an abutment, and directly attributable to the flow field developed by flow passing around an abutment. This definition excludes other flow and channel-erosion processes such as lateral geomorphic shifting of the bridge approach channel but includes contraction and abutment scour as part of the same physical processes that should be treated together rather than separately in their estimation. The review shows that, since 1990, advances have been made in understanding abutment-scour processes, and in (1) estimating scour depth at abutments with erodible compacted earthfill embankments, and at those with solid-body (caisson-like) foundations; (2) identifying the occurrence of at least three distinct abutment scour conditions depending on abutment location and construction; (3) utilizing the capacity of numerical modeling to reveal the flow field at abutments in ways that laboratory work heretofore has been unable to provide. The review identifies and evaluates leading scour formulas and suggests a framework for developing a unified abutment scour formula that depends on satisfying several targeted future research needs.

EXECUTIVE SUMMARY

INTRODUCTION

The objective of this study is to review the present state of knowledge regarding bridge-abutment scour and evaluate the leading methods currently used for estimating design scour depth. It focuses on research information obtained since 1990, and that must be considered in updating the scour-depth estimation methods recommended by AASHTO¹, and used generally by engineering practitioners. This summary defines the problem of abutment scour, describes the study's research approach, and presents its findings along with recommendations and suggestions for future research projects.

The study builds on the three principal investigators extensive knowledge regarding abutment scour, and capitalizes on the insights of an expert panel consisting of leading academicians and engineering consultants who also have significant experience with abutment scour. An extensive and thorough series of 2-3 day workshops over the life of the project were conducted by the principal investigators with the results presented to the panel of experts and to the NCHRP review panel. In this manner, conflicting points of view and commonly held misinformation about abutment scour have been debated and clarified in completing this study. Collective physical insights have been integrated into an expert system of organizing, collating, and evaluating current knowledge to create a solid base from which future research needs are effectively identified and outlined in order to advance the methods needed for engineers to design safer bridges.

PROBLEM STATEMENT

The complexity of bridge abutment scour necessitates a thorough evaluation of the physical processes involved and their parameterization in scour depth estimation formulas. As river flow approaches a bridge, the streamlines converge due to the physical contraction in width and then diverge once through it. In this process, the flow passes around bluff bodies, generating, transporting, and eventually dissipating large-scale turbulence structures (large eddies shed in a recognizable pattern due to flow separation albeit intermittently with time). The flow is bounded by erodible boundaries of complex and changing form that have widely varying compositions and characteristics. Even the classification of abutment scour as an independent bridge scour component is problematic, because contraction scour and abutment scour are linked processes usually occurring together during flood events. Given the complexity of the various scour processes, and the difficulty of including all of those processes in a single empirical formula, it is not surprising that current abutment scour formulas commonly provide scour depth estimates that vary over a wide range of magnitudes. Furthermore, comparisons of abutment scour depth estimations from existing formulas with field data and with engineering experience produce mixed results, partly because of the misperception that abutment scour formulas based on simplified laboratory experiments apply to all types of abutment scour, even to the most complicated field situations, and partly due to the difficulty of estimating the flow and sediment parameters required in existing scour formulas.

Even with the foregoing complexities, some progress has been made in understanding abutment and contraction scour in the past twenty years or so, but future advances require identifying the most useful concepts and then winnowing and unifying some of these concepts into an

¹ AASHTO ~ Association of American State Highway and Transportation Officials

overarching design philosophy buttressed by fulfilling carefully focused and defined research needs.

OBJECTIVES

The study's specific objectives are:

1. Critically evaluate research completed since 1990 in abutment and contraction scour processes;
2. Compare current scour-prediction practice with the present understanding of scour processes through a clear delineation of the major variables governing abutment and contraction scour;
3. Provide recommendations for adoption of specific research results by AASHTO and use by the engineering community if possible; and,
4. Where knowledge gaps exist, develop a logical and comprehensive set of research needs and problem statements to fill them in the near future.

RESEARCH APPROACH

The research approach can best be described as one of expert systems analysis and evaluation. The three co-principal investigators, who have all done extensive research on abutment scour, pooled their knowledge and experience and augmented it with the insights of an expert panel consisting of leading academicians and engineering consultants who also have significant experience with abutment scour. The co-principal investigators conducted an extensive and thorough series of 2-3 day workshops over the life of the project and periodically presented the results to the panel of experts and to the NCHRP review panel in interactive oral presentations as ideas were refined and incorporated into the research product in a feedback loop. In this manner, conflicting points of view and commonly held misinformation about abutment scour were debated and clarified. Collected insights were integrated into an expert system of organizing, collating, and evaluating current knowledge to create a solid base from which future research needs could be effectively identified and outlined in order to advance the methodologies needed for engineers to design safer bridges.

As part of the overall research approach, the following criteria were established to evaluate existing scour-depth prediction formulas in order to identify those that may provide promise and direction or even a framework for future research:

1. Adequacy of formulas in addressing parameters that reflect the important physical processes governing abutment scour;
2. Limitations of formulas in design applications with respect to ranges of controlling parameters on which they are based;
3. Categorization and acceptability of laboratory experiments and research methods that led to the formulas;
4. Attempts to verify and compare formulas with other lab data and field data, if any, with which a valid comparison can be made;
5. Applicability and ease of formula use for design (AASHTO manual)

RESEARCH FINDINGS

At the outset, it was necessary to re-examine the definition of abutment scour because of its close association and interaction with contraction scour. Abutment scour is defined herein as **scour at the bridge-opening end of an abutment, and directly attributable to the flow field developed by flow passing around an abutment.** It includes the effects of flow acceleration due to channel flow constriction as well as local, large-scale turbulence effects due to flow separation which are present in varying relative proportions depending on the upstream approach flow distribution and flow distribution at the bridge section, abutment column type, foundation type and location, flow curvature, and near-field river morphology. Several of the most important research insights are summarized below.

A New View of Abutment Scour

Based on the foregoing definition of scour and documentation in this report of numerous failures of bridges due to abutment scour, one of the important initial findings is that many abutment failures occur due to scour and sliding of the earthfill embankment on the main stream side of the abutment into the scour hole, or outflanking due to erosion of the earthfill embankment on the floodplain side due to overtopping or inadequate drainage protection. Even more difficult to evaluate is the vulnerability to scour caused by lateral shifting of the channel thalweg such that it directs flow adversely towards abutments and embankments.

Whereas much of the laboratory research of recent years has focused on solid abutments that extend into the soil foundation, such as with sheet piles or other fairly rigid foundations, more attention should be focused in the future on erodible embankments. Recognition of the difference between erodible and solid abutments provides a factor for classifying existing scour prediction formulas and introduces the importance of geotechnical failure caused by hydraulic scour. In addition, it suggests the need for estimating the strength of the embankment over the range of construction forms varying from unprotected, compacted soils of various types through rock riprap revetment to the solid abutment, and incorporating this estimate into a more comprehensive scour prediction formula. These considerations pose a fundamental design problem in that partial failure of the embankment that occurs as sliding of earthfill and/or riprap into the scour hole may ultimately reduce the total scour depth while complete failure of the embankment may be intolerable if it results in failure of the bridge approach slab or the first bridge span.

Classification of Scour Formulas

To apply the foregoing criteria for evaluation of the adequacy and limitations of existing scour prediction formulas, several classification schemes were developed as explained next.

Classification by Abutment Scour Conditions

For erodible embankments, three common conditions of abutment scour are identified

1. **Scour Condition A.** Scour of the main-channel bed, when the channel bed is far more erodible than the floodplain may cause the main-channel bank to become geotechnically unstable and collapse. The collapsing bank undercuts the abutment and embankment, which in turn collapses locally and results in soil and/or riprap sliding into the scour hole;
2. **Scour Condition B.** Scour of the floodplain around the abutment. This condition also is equivalent to scour at an abutment placed in a rectangular channel, if the abutment is set

far back from the main channel. Given the floodplain resistance to scour, this scour condition usually occurs as clear-water scour and can result in soil and riprap sliding into the scour hole as in Scour Condition A;

3. **Scour Condition C.** Scour Conditions A and B may eventually cause the approach embankment to breach near the abutment, thereby fully exposing the abutment column. For this condition, scour at the exposed stub column essentially progresses as if the abutment column is a pier, and it usually occurs as clear-water scour.

Scour conditions A and B can also occur for solid abutments that are located near the main channel bank, or on the floodplain some distance from the bank. In this case, abutment failure would result if the scour hole were deep enough to undermine the solid foundation. Scour Condition C would tend to occur for a solid abutment in the case of outflanking of the abutment and erosion of the approach embankment.

Classification by Types of Bridge Crossings

The three scour conditions identified in the previous section may occur within the context of specific classes of bridge crossings:

1. Class I refers to narrower bridge crossings of incised channels, where the channel is reasonably well represented by a rectangular channel. This class also includes narrow crossings for conditions up to bank-full flows.
2. Class II refers to wider bridge crossings, where the channel is typically compound, comprising a main channel and wide flood channels. At such sites, significant flows may be diverted from the flood channels towards the main channel at the bridge section.
3. Class III refers to bridges spanning wide braided river channels, where the river channel can be approximated by a rectangular channel under extreme flood flow conditions. At such sites, the bridge foundations may be significantly skewed to the flow at lesser flood flow conditions.

Class I and Class III are the simplest situations to model in the laboratory. Many of the existing laboratory data apply to these two classes, which have been modeled typically in rectangular flumes using rigid abutment models extending below the maximum measured scour depth. Equations derived from such data give the “maximum possible” scour depth that can occur and should then be conservative for design. Such equations are not suitable for prediction of scour depths that develop where undermining of the pile cap or slab footing occur, because slope failure may then limit further scour. Scour Conditions A and C are the most likely for Class I and II bridge crossings.

All three scour conditions (A, B, and C) are possible for Type II crossings of compound channels which consist of both a main channel and floodplain. Class II crossings are the most difficult in terms of scour prediction because of the interaction between the main channel and floodplain flows and the resultant redistribution of the flow in the contracted bridge section depending on how much of the floodplain flow is blocked by the embankment. A fourth scour condition might be added to the Type II crossing: Scour Condition AB for an abutment with a small setback distance in which both the floodplain and the bank of the main channel are erodible and the scour hole on the floodplain extends into the main channel.

Classification by Parameter Groups

From the dimensional analysis of the abutment scour problem, it can be shown that specific groups of dimensionless parameters exist that define different aspects of the physics of the problem. These parameter groups are given as

- G1. Flow/sediment variable ratios such as the flow intensity defined as the ratio of the approach flow velocity to the critical velocity for initiation of sediment motion, V/V_c ;
- G2. Relative abutment and sediment size scales given by the ratio of embankment length to sediment size, L/d ;
- G3. Abutment and flow geometry variables such as the ratio of embankment length to flow depth, L/Y , and abutment shape and skewness factors, K_s and K_θ ;
- G4. Flow distribution ratios such as the ratio of the discharge per unit width in the approach flow section to that in the contracted bridge section, q_2/q_1 ;
- G5. An abutment stability parameter that quantifies the shear strength of the embankment relative to the intergranular grain stress due to the height of the embankment

Parameter Group G1 is essential in establishing the potential for scour through the ratio of some flow variable, such as velocity or shear stress, to a variable indicating critical conditions for sediment movement. This parameter can take a variety of forms including a densimetric grain Froude number as well as the common V/V_c . Establishing the effect of the scale of the horseshoe vortex relative to sediment size is the intent of Parameter Group G2, but not enough is known at this stage to firmly establish what this parameter or parameters should be. The influence of flow contraction on abutment scour is incorporated into existing scour formulas by either Parameter Group G3 or G4 with the ratio of length scales utilized in the former and discharge ratios in the latter. Parameter Class G5 is somewhat unique in that it has not been utilized in existing abutment scour formulas although introduction of erodible embankments into the design problem suggests the need for a parameter of this type.

Comparison, Evaluation and Selection of Scour Formulas

From an extensive review and analysis of contraction scour, and consideration of the common parameter classes affecting abutment and contraction scour, it was concluded that the most promising treatment of the combined occurrence of bridge and abutment scour is to establish the total effect as an amplification factor times a reference contraction scour depth. The reference depth would be obtained from well-established contraction scour formulas that depend on the assumption of equilibrium sediment transport in the live-bed case and the occurrence of critical conditions in the equilibrium scour hole in the clear-water case. The amplification factor would be developed as a function of degree of flow contraction caused by the constricted bridge opening as well as the local turbulence generated by flow obstruction and separation as described previously.

An extensive comparison of the performance of leading scour formulas against each other and against sound experimental data bases established a short list of scour prediction formulas that displayed similar trends in terms of the reference contraction scour depth formulation. This smaller list of formulas was further subjected to the classification schemes and the selection criteria developed for this purpose. Finally, a common parameter framework was established that

encompassed both solid abutments and erodible abutments. While no formula was found to satisfy all criteria, the framework developed as a result of this research approach suggests a path toward refining and unifying a small number of leading scour formulas.

RECOMMENDATIONS

1. Contraction scour should be viewed as a reference scour depth calculation while abutment scour should be taken as some multiple of contraction scour rather than additive to it.
2. A small subset of abutment scour formulas, each member of which has certain desirable attributes, should be unified into a single formula in order to develop more realistic and robust procedures for abutment scour prediction. The following formulas are judged to be most promising in this regard, and with respect to the established criteria:
 - a. Ettema et al. (2010). It is the only formula that considers an erodible embankment; it has the desirable attributes of reflecting the physics of the abutment scour process both in terms of flow constriction and turbulent structures.
 - b. Sturm (2004, 2006) It includes a method of accounting for flow re-distribution due to compound channel geometry, and it represents the upper limit of scour for a solid-wall foundation as opposed to an erodible embankment.
 - c. Melville (1997) It is most applicable to short, solid-wall abutments and depends on abutment length rather than the flow distribution in the contracted section, but it can be viewed as comparable to the first two formulas.
 - d. ABSCOUR (Chang and Davis 1998, 1999; MSHA 2010) It contains the desirable attribute of including the direct effect of flow re-distribution on the floodplain through the Laursen contraction scour formula and has a computer implementation.

Although the Briaud (2009) formula does not satisfy the criterion for best parameter framework, it is one of the only databases for cohesive sediments, and the data could be useful in expanding the range of applicability of the final unified formula.

3. A flow chart should be developed to be used as a guide to evaluate abutment scour in an informed manner and to assist the judgment of design engineers including both a unified scour formula and geotechnical evaluation of scour. For more complex problems, hybrid numerical and physical models should become a readily accessible option.
4. In the near term, abutments should have a minimum setback distance from the bank of the main channel with riprap protection of the embankment including a riprap apron, and other effective scour countermeasures such as guidebanks should be considered (see Lagasse et al. 2009, HEC-23)
5. Further development of an educational curriculum for hydraulic engineers should be undertaken in order to emphasize the proper choice of parameters that go into any scour calculation and in the use of 2D and 3D numerical models to better evaluate the hydraulic parameters. At least in the short term, 2D numerical models should be used on all but the simplest bridge crossings as a matter of course.
6. A long-term field program of obtaining high-quality, real-time field data should be undertaken. While embarking upon such a program will be expensive and require

patience, the results will move the ultimate solution to the abutment scour problem forward more effectively than less-expensive post-flood surveys.

CONCLUSIONS

This study leads to the following main conclusions regarding its objectives:

1. Abutment-scour literature published since 1990 documents substantial advances in understanding abutment-scour processes:
 - a. New insights exist regarding scour development at abutments with erodible, compacted earthfill embankments. Differences occur between scour at erodible abutments and scour at solid abutments on solid-wall foundations similar in nature to sheet piles or caisson structures;
 - b. The flow field around an abutment has essentially the same characteristics as flow fields through short contractions. Notably, flow distribution is not uniform and generates large-scale turbulence. Deepest scour occurs approximately where flow contraction is greatest. As scour develops at abutments with solid-wall foundations, the large-scale turbulence may increase in strength and cause scour to deepen;
 - c. At least three abutment scour conditions may develop at abutments with erodible embankments, depending on abutment location in a compound channel. Two conditions may result in embankment failure, while the third condition is pier-like scour at an exposed abutment column once an embankment has been breached;
 - d. The roles of variables (e.g., embankment length) and dimensionless parameters (e.g., embankment length relative to flood-plain width and relative flow distribution in compound channels) defining scour processes have become better understood;
 - e. The leading methods for estimating scour depth better reflect parameter influences;
 - f. Improved insights exist regarding abutment scour in clay;
 - g. Insight has been gained regarding the influence of some site complications (e.g., pier proximity); and,
 - h. Numerical modeling is substantially growing in utility to reveal two- and three-dimensional features of flow distribution at abutments in ways that laboratory work heretofore has been unable to provide.

2. The following aspects of abutment scour processes remain inadequately understood:
 - a. The role of embankment soil strength and flood-plain soil strength on scour development and equilibrium scour depth;
 - b. Scour of boundary materials whose erosion characteristics are not adequately understood (some soils, rock); however, existing reliable data indicate that scour depths in cohesive soils and weak rock do not exceed those in cohesionless material;
 - c. Quantification of factors further complicating the abutment flow field (such as debris or ice accumulation, submergence of bridge superstructure, channel morphology) and erodibility of flood-plain soils; and,
 - d. Temporal development of abutment-scour depth, especially the relative timings for which scour develops at several locations around an abutment.

3. The evaluation (Chapter 5) outlines the well-understood relationships between scour depth and significant parameters, summarized in Table 5-1. Notable examples of recent information include similitude in hydraulic modelling of flow distribution through a contracted bridge waterway, and the importance of flood-plain and embankment soil strengths. Groups of primary parameters are identified in Table 5-2. They define the magnitude and approximate distribution of the abutment flow field, and therefore the potential maximum scour depth.
4. An important conclusion drawn from the evaluation (Chapter 6) is the need to define a set of methods for estimating abutment-scour depth associated with different abutment types, notably for abutments with erodible embankments and those with solid-wall foundations:
 - a. For abutments with erodible embankments, the estimation methods proposed by Ettema et al. (2010) and ABSCOUR (MSHA 2010) should be further developed with a view to producing a set of methods for scour-depth estimation;
 - b. For abutments with erodible embankments, further research is needed to develop and verify the geotechnical approach to scour depth estimation; and,
 - c. For abutments with solid-wall foundations, the estimation methods proposed by Sturm (2006) and Melville (1997, also Melville and Coleman 2000) should be further developed with a view to producing a comprehensive method for scour-depth estimation.
5. The evaluation in this report draws attention to the importance of effective monitoring and maintenance of bridge abutments. Bridge waterway site complexity (flow field, foundation material, embankment material) can introduce significant uncertainty for scour-depth estimation. Moreover, risks attendant to channel changes and possible deterioration of the abutment structure introduce additional uncertainties as to abutment condition. Effective monitoring (inspection schedule and instrumentation) is needed to manage and mitigate the uncertainties.
6. It is important that the abutment designer recognize the limits of existing methods for scour-depth estimation and the capabilities of new field and numerical modelling tools through updated continuing education courses.
7. Detailed research needs related to Conclusions 4, 5, and 6 can be found in Tables 8-1, 8-2, and 8-3 with expansion into research problem statements in Appendix C. The main research needs shown there are identified as *Critical* priority as decided by the NCHRP Project Panel. Work should commence on this road map for the future as soon as possible.

CHAPTER 1

INTRODUCTION

This report reviews the present state of knowledge regarding bridge-abutment scour and evaluates the leading methods currently used for estimating design scour depth. It focuses on research information obtained since 1990, which is to be considered in updating the scour estimation methods that are recommended by AASHTO², and used generally by engineering practitioners. Though considerable further progress has been made since 1990, the findings indicate that several important aspects of abutment scour processes remain inadequately understood. Moreover, the current methods for scour depth prediction do not adequately take into account the physical scour processes. The state-of-art for abutment scour prediction is considerably less advanced than that for pier scour prediction.

The review and its recommendations were prepared for eventual use in updating the two AASHTO manuals Policy for Design of Highway Drainage Facilities and Recommended Procedures for Design of Highway Drainage Facilities, so that these manuals present the best available guidelines for abutment scour estimation and countermeasure design, and provide clear direction as to further research. The recommendations are particularly intended to be used by AASHTO in developing policies and procedures for use in addressing bridge abutment scour.

The review draws upon a broad range of sources of information regarding abutment scour, including agency reports, books, and technical papers. Close attention was given to recent NCHRP project reports on abutment scour; e.g., “Estimation of Abutment Scour” (NCHRP Project 24-20), “Abutment Scour in Cohesive Materials” (NCHRP 24-15(2)); and, “Abutment Scour Countermeasures” (NCHRP Project 24-18). Additionally, the review builds on that by Parola et al. (1996), who provide a useful earlier wide-ranging assessment of research needs regarding bridge waterway scour.

1.1 DEFINITIONS

At the outset of this report it is necessary to define the terms abutment, abutment scour, and abutment failure. These terms are not clearly defined in scour literature or in the common vernacular about scour.

Abutments comprise several structural parts, notably an abutment column supporting one end of a bridge deck, and the column which is set amidst, or backed by, a compacted earthfill approach embankment. **This review may use the term “embankment/abutment” to describe the full structure – approach embankment and abutment column structure, but where necessary the separate terms will be applied for clarity.** The “embankment” is considered to be the earthfill that extends from the abutment column into the floodplain away from the stream, while the term “abutment” refers to the column and the support structure facing the stream. Chapter 2 describes the main features of abutment structure and form.

² AASHTO ~ Association of American State Highway and Transportation Officials

Abutment scour herein is taken to be scour at the bridge-opening end of an abutment, and directly attributable to the flow field developed by flow passing around an abutment. It includes the effects of flow acceleration due to channel flow constriction as well as local large-scale turbulence effects due to flow separation which are present in varying relative proportions depending on the upstream approach flow distribution and flow distribution at the bridge section; abutment column type, foundation type and location; flow curvature; and near-field river morphology. Other flow and channel-erosion processes cause scour at abutments. One such process often leading to abutment failure is lateral erosion and shifting of the approach channel immediately upstream of an abutment as part of a long-term geomorphic process; the approach flow then impinges against the abutment flank. Many field observations of abutment scour mix abutment scour (as defined above) and scour caused by channel shifting. Chapter 4 explains the current understanding of abutment scour.

Abutment scour may cause embankment failure, abutment column failure, or both. **Observations of abutment scour indicate that scour frequently may initiate a geotechnical-type failure of the earthfill embankment.** Failure of the abutment column itself is less commonly observed. Although failure of the embankment may occur with the abutment column (and bridge structure) remaining intact, it is a most undesirable condition that renders the bridge approach dangerous for road vehicles. Chapter 3 elaborates abutment scour conditions and the various modes of bridge abutment failure.

1.2 MOTIVATION FOR REVIEW

The need to evaluate present knowledge about abutment scour processes and failure conditions, and determine the extent to which existing scour-estimation methods reflect this knowledge, is expressed in several publications prepared by national agencies and societies in the US: e.g., NCHRP Reports 24-08 (“Scour at Bridge Foundations: Research Needs”) and 20-07(178) (Parola et al. 1996, Lagasse and Zevenbergen 2004), as well as NCHRP Report 417 (Parola et al. 1998), USGS (2003), and Kattell and Eriksson (1998).

However, few situations of water flow and boundary erosion are more complex and challenging to understand than those associated with scour of bridge abutments. The sketches in Figures 1-1 and 1-2 convey a sense of the complexities faced during estimation of scour depths at bridge waterways. Abutment sites may vary widely in their specific details. Figure 1-1 illustrates a wide, multi-span bridge whose abutments are considerably set back from the bank on broad flood plains. As depicted in Figure 1-2, the abutments for shorter bridges are in close proximity to each other; in such cases the abutments often may be set close to the bank of a channel whose morphology is quite irregular and varies markedly with flow stage.

Both Figures 1-1 and 1-2 indicate how flow approaching a bridge waterway converges then diverges once through it. As it does so, it passes around bluff bodies, generating, transporting, and eventually dissipating large-scale turbulence structures (large eddies shed in a recognizable pattern due to flow separation albeit intermittently with time). The flow is bounded by erodible boundaries of complex and changing form that have widely varying compositions and characteristics. Even the classification of abutment scour as an independent bridge scour component is problematic, because contraction scour and abutment scour are linked processes that usually occur together during flood events.

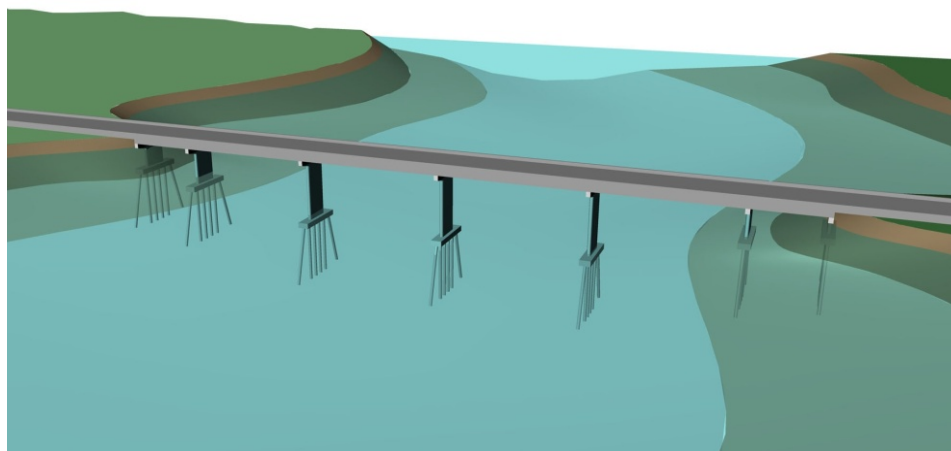

Figure 1-1. Schematic of long, multi-span bridge over a compound channel.

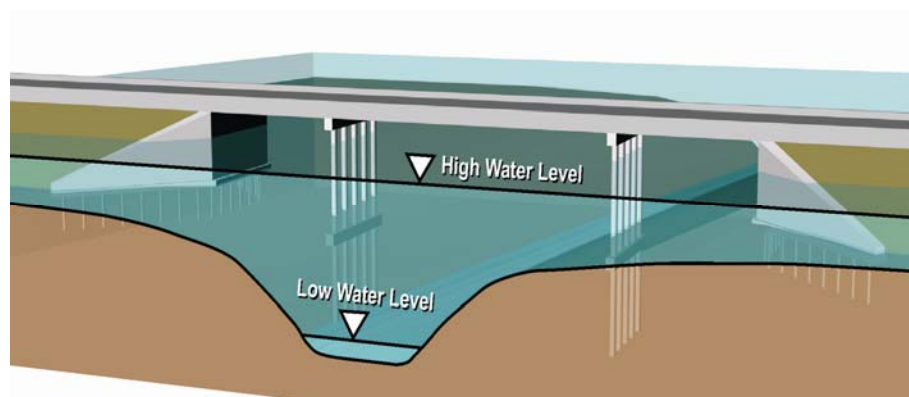

Figure 1-2. Schematic of relatively short bridge over a narrow main channel.

Furthermore, the sketch in Figure 1-3 shows the effect of hydraulic erosion of bed and banks on the integrity of certain boundary components (banks and embankments) after a geotechnical slope-stability failure. Such failures add additional complexity to waterway flow and scour, and thereby to scour-depth estimation. It can be readily appreciated from Figures 1-1 through 1-3 that scour indeed is a long-standing and vexing problem in hydraulic-engineering research, not to mention bridge foundation design.

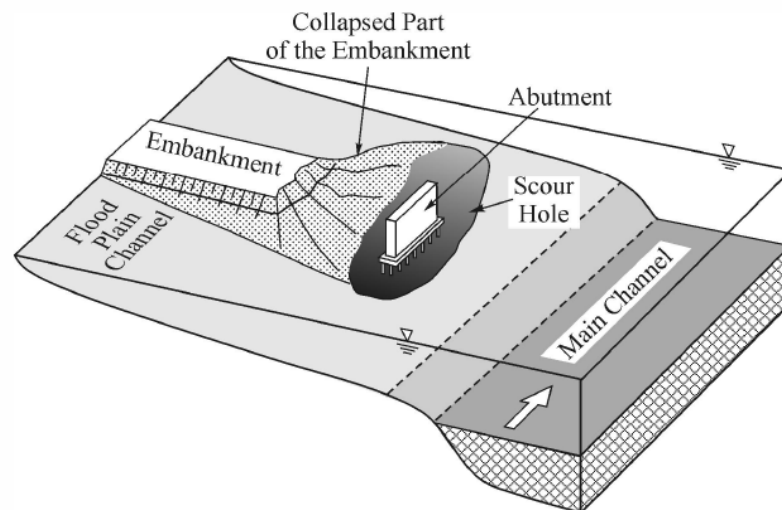

Figure 1-3. Abutment scour resulting in embankment failure by collapse due to geotechnical instability.

The development of practical design methods for predicting scour depths at bridges has been hampered by inadequate knowledge about, and formulation of, important component processes and their interaction during scour. The scour-estimation methods presently available do not adequately take all these considerations into account. As would be expected, early work on abutment scour focused on the simpler and idealized situations of scour; notably, abutment scour simulated as scour at a rigid structure extending at depth into a bed of uniform sand. Commensurately, the existing relationships and guidelines apply to simplified abutment situations, such as an abutment placed in a straight rectangular channel, and are roughly based on empirical or regression equations fitted to a collection of data from laboratory tests with model abutments (whose construction does not always resemble that of actual abutments). Such design relationships can only be extrapolated with considerable uncertainty to actual field conditions. That extrapolation often results in overly conservative estimates of scour depth. Conservatism is understandable and indeed useful, but can be expensive for large abutment structures.

Moreover, when existing design methods inadequately embody certain scour processes, there is a risk that the manner or location of actual scour failure will differ from that assumed for the estimation relationship or guideline. Additionally, an overlooked process may trigger or exacerbate scour at a site where a scour problem had not been anticipated. There are several prominent knowledge gaps about processes whereby scour could occur in ways and places not accounted for by existing prediction methods or programs of bridge monitoring (e.g., geomorphic change in channel alignment, inadequate estimation of peaks and periods of design flows, proximity of old or new bridges, the role of large-scale turbulence, inadequate control of storm-water drainage at the bridge site). These gaps are not only limited to flow and geomorphic processes but also relate to sediment type in terms of fine-grained sediments, which experience interparticle physico-chemical forces, and coarse grained sediments whose movement is resisted by gravity forces alone.

The threat posed by scour was realized early in the struggle to construct and maintain bridges. Over the ages it has been dealt with in several ways, but the threat has not yet been adequately addressed. In antiquity, for instance, Roman engineers recognized the threat. Whenever they built a new bridge they usually would place on the bridge an appeasing inscription to Janus, the Latin god of bridges (and portals generally), or to the local deity of the river or stream being crossed. Engineers in Japan and Korea reduce the threat for bridge abutments at major, levee-flanked rivers flowing through heavily urbanized regions. They do so by not locating bridge abutments on the floodplain, but instead locating them outside the levee; in this manner, flow contraction through a bridge waterway is minimized or practically eliminated, and the abutments are not exposed to scour. On the whole, though, bridge scour continues to be a threat. The case depicted in Figure 1-4 is an example of scour failure that occurred fairly recently (1993 flood in Midwestern U.S.) for an unusually large flow that exceeded the design flow for the bridge waterway. The maximum scour depth measured two months after the flood was 17 m in the floodplain on the upstream side of the bridge (Parola et al. 1998).



Figure 1-4. Scour at I-70 bridge over Missouri River from 1993 flood. Flow was from left to right. (Photo from Parola et al. 1998).

1.3 OBJECTIVES

The principal objectives of this review are as follow:

1. Complete a critical evaluation of knowledge about abutment scour processes, using especially research conducted since 1990;
2. Compare current scour-prediction practice with the present understanding of scour processes; and,
3. Develop recommendations for adoption of specific research results by AASHTO and use by the engineering community in general.

In pursuing these objectives, the review constructs a well-illuminated explanation of the physical processes attendant to scour at abutments, and delineate the validity limits of existing scour-prediction methods. From this basis, the review indicates the prospects for substantial improvements in estimating scour depths, and thereby better abutment design.

Two points require emphasis at the outset of this report:

1. The state of knowledge regarding abutment scour considerably lags that for pier scour; and,
2. A major education effort is needed to better inform engineers about the processes associated with abutment scour. In particular, the geotechnical aspects of abutment scour and failure have received inadequate attention heretofore.

1.4 Approach

Three important considerations guide the approach taken for the present review:

1. Abutment scour must be viewed from the perspective of flow and scour through the entire bridge waterway, because abutment scour normally cannot be dissociated from flow and bathymetric conditions across the bridge waterway;
2. Abutment construction influences scour, as the type of abutment affects maximum scour depth and location; and,
3. Abutment scour comprises processes of hydraulic erosion, which may cause geotechnical instability of the embankment earthfill and possibly the foundation upon which the abutment is based.

These considerations lead to the necessary insights regarding abutment scour, and provide the requisite framework of inquiry for understanding abutment scour.

CHAPTER 2.

ABUTMENT FORM AND CONSTRUCTION

The main design characteristics of an abutment can be described in terms of abutment form, the overall layout of an abutment's approach embankment, and the abutment's construction configuration. These characteristics, together with the waterway's channel morphology, boundary sediments and soils, as well as flow-resistance features (e.g., vegetation state of the floodplain), influence the flow field around the abutment, and therefore, scour. A striking, and somewhat complicating, characteristic of bridge abutments is that few abutment situations are alike, as Figures 1-1 and 1-2 exemplify. Accordingly, the development of a method for estimating scour depth at abutments requires that the abutment forms, layouts, and construction configurations of common practical importance be identified.

2.1 ABUTMENT FORM

Two general forms of abutment exist as illustrated in Figure 2-1:

1. Wing-wall abutments, including vertical-wall abutments; and,
2. Spill-through abutments

Spill-through abutments have sloped sides, whereas wing-wall abutments have a vertical face and wing-walls that retain an earthfill approach embankment. The wing-walls can be oriented at various angles to the abutment's central panel, although a 45° angle is representative. A wing-wall abutment with wing-walls angled at 90° to its central panel is sometimes called a vertical-wall abutment, and it is fairly common for small abutments. Sheet-pile caissons extending into channels also may be viewed as a type of vertical-wall abutment. Various alternative names exist for these two general abutment forms.

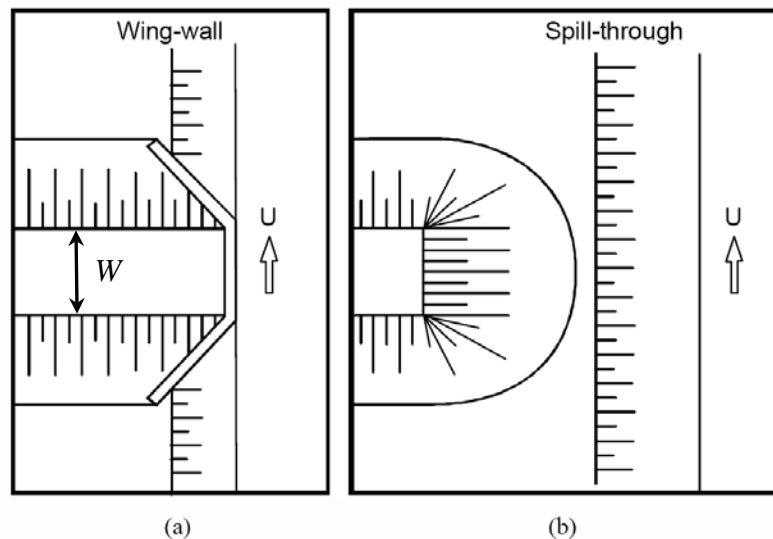

Figure 2-1. Plan views of the two common abutment forms: (a) Wing-wall; (b) Spill-through (Ettema et al. 2010).

2.2 ABUTMENT LAYOUT

In a somewhat simplified manner, it is useful to discuss abutment layout in terms of the length, L , of approach embankment, floodplain width, B_f , main channel width, B_m , overall width of the main channel and floodplain at a bridge crossing of a waterway, B , and embankment top width, W . These variables are indicated in Figure 2-2 except for W which is shown in Fig. 2-1.

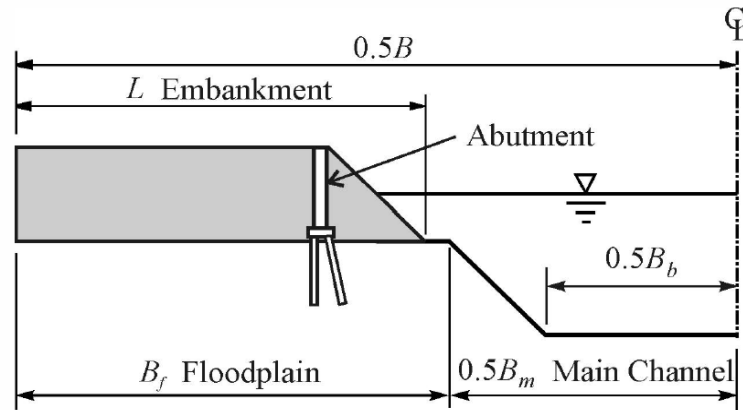

Figure 2-2. Definitions of embankment length, floodplain width, and main channel width (Ettema et al. 2010).

Bridge abutments can be characterized as conforming to the following layout arrangements, which can be represented in terms of the variables L , B_f , and B :

1. The abutment is located on the floodplain of a compound channel ($L \leq B_f$). This layout is typical for spill-through abutments. It is usual for the abutment to be set back from the main-channel bank so that a vehicle (and wildlife) can pass between the abutment and the bank. A minimum setback distance of about 10 ft (3.05 m) is common practice, if site layout allows, but the setback distance on large rivers with wide floodplains may be considerably more ;
2. The abutment extends up to the bank of the main channel ($L \approx B_f$). This layout is typical for wing-wall abutments, especially for channels having a narrow, or no, floodplain. Wing-wall abutments are common for bridges over small streams; and,
3. The abutment is located in a rectangular channel, and no floodplain is present. This layout is not common, although it is essentially similar to a relatively short abutment on a wide floodplain and is representative of wide-braided channels. Also, it is similar to channel-control structures (e.g., spur-dikes, groins, barbs, hard-points), coffer-dams, and construction caissons.

The nature of an abutment inevitably requires that the layout of an abutment be tailored to fit the local topography of a bridge site. Therefore, to varying extents each abutment inevitably differs in layout. Other variations in abutment layout can be found; e.g., many small bridges in Maine have wing-wall abutments that extend into the main channel (Lombard and Hodgkins 2008).

2.3 ABUTMENT CONSTRUCTION

It is usual for the top width of the earthfill embankment to accommodate minimally a road width of 24 ft (7.22 m) plus two shoulders of width 8 ft (2.41 m), giving an overall top width of 40 ft (12.04 m). The side-slopes of earthfill approach embankments commonly are set at 2H:1V, though slopes range from about 2H:1V to 3H:1V. Figure 2-3 is an isometric view of the geometry used for spill-through abutments. The embankment geometry for wing-wall abutments is essentially similar to that shown in Figure 2-3, except that the vertical face of a wing-wall abutment retains the end of the embankment.

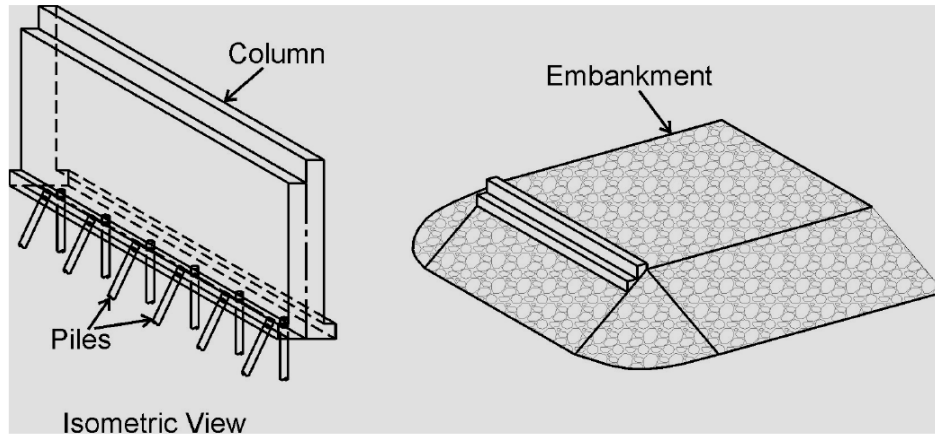

Figure 2-3. Isometric view of spill-through abutment comprising a standard-stub column located within the end of an earthfill embankment (Ettema et al. 2010).

Abutments usually comprise a concrete support wall founded on a pile cap supported by piles or on a spread footing, and adjoin an earthfill approach embankment. Pile supports are more common than are footing supports, unless the abutment is founded directly on rock. Spill-through abutments are formed around a “standard-stub abutment,” which comprises a concrete stub supported by a pile cap on two rows of circular piles. The design and dimensions of a common standard-stub abutment column are shown in Figure 2-4. Wing-wall abutments usually have similar foundation layouts as the standard-stub abutments, except that they include wing-walls extending from the central stub. Figure 2-5 shows the design and dimensions of a common wing-wall abutment.

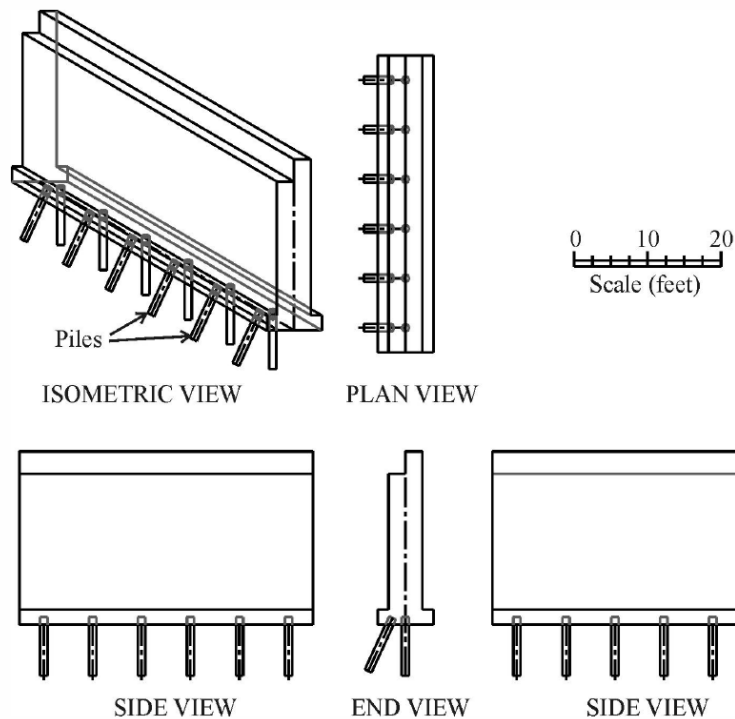

Figure 2-4. The geometry and dimensions of a standard-stub abutment commonly used for spill-through abutments (prototype scale indicated); design provided by the Iowa DOT (Ettema et al. 2010).

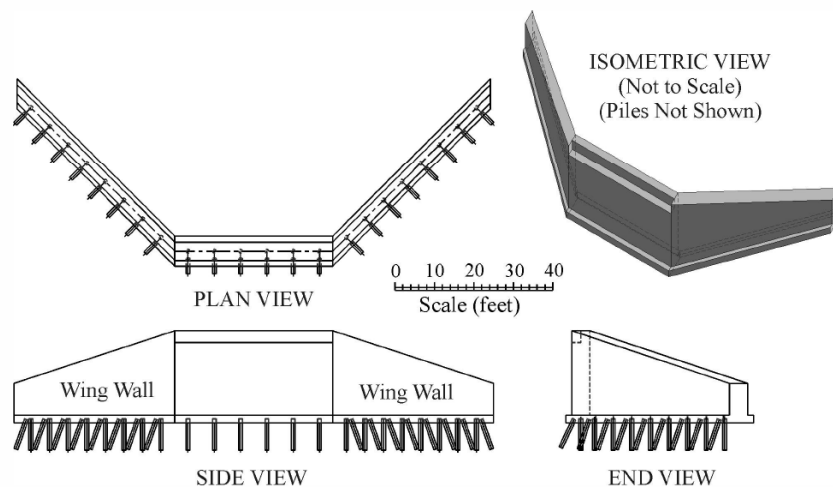

Figure 2-5. The geometry and dimensions of a wing-wall abutment - compacted earthfill embankment extends back from the abutment structure (prototype scale indicated); design provided by the Iowa DOT (Ettema et al. 2010).

The elevation of the pile cap and the detailed arrangement of piles may vary from bridge site to bridge site. At some sites, the pile cap is located at, or near, the top elevation of the floodplain, whereas at other sites the piles extend upward through the embankment earthfill. In this latter case, the piles directly support a cross beam, which in turn supports the beams of the bridge deck. Also, for some sites, wing-wall abutments may be supported by sheet piles driven in approximately the same plan layout as the abutment.

The foregoing descriptions of common abutment forms and construction arrangements are not reflected in the leading design guides and bridge-monitoring guides addressing scour at bridge abutments. For example, FHWA's (2009) guide for bridge inspectors does not fully portray the complexity of an abutment structure and its flow field, or possible failure mechanisms due to scour, as elaborated in this report. Chrisohoides et al. (2003) and Ettema et al. (2010), for example, provide useful visualizations of abutment flow, as currently understood.

2.4 PIER PROXIMITY

Many bridges over rivers are constructed with a comparatively short first deck span, such that a pier is located very close to an abutment. There are construction-economy advantages in having the pier close to the abutment and riverbank, and the arrangement often facilitates a clear span over the river. This construction advantage, however, raises a question as to whether pier proximity could adversely influence abutment scour (and vice-versa). Figure 2-6 depicts an example of a bridge with a pier located close to an abutment.

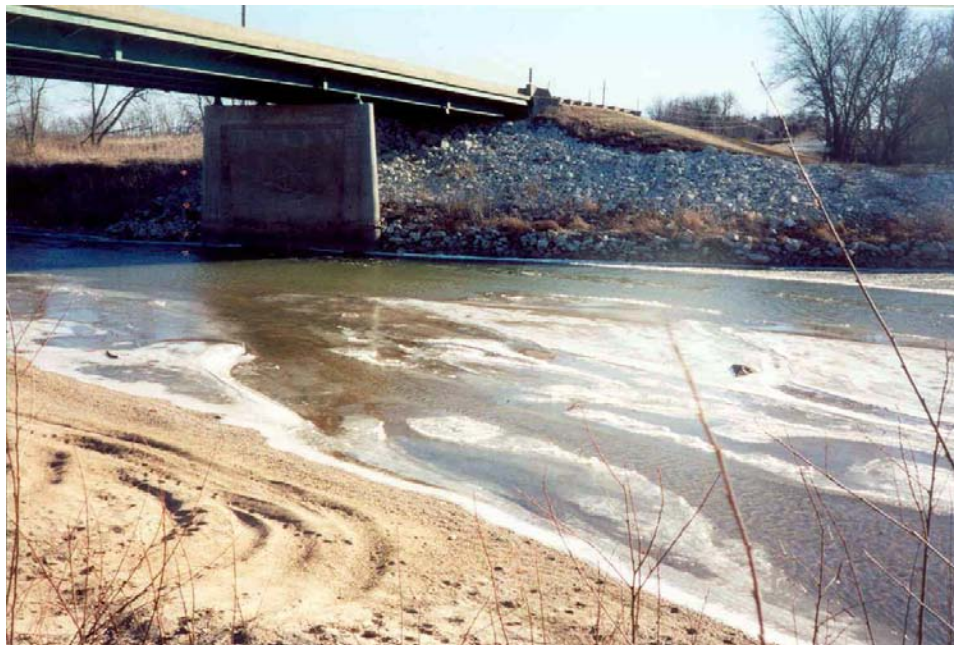

Figure 2-6. A spill-through abutment with a pier in close proximity; approximate layout proportions of $L/B_f = 1.0$; $B_f/0.5B \approx 0.7$, and $L/W \approx 1.0$, in which $W =$ embankment top width (Ettema et al. 2010).

2.5 SEDIMENT AND SOIL BOUNDARY MATERIAL

The boundary material of the main-channel, floodplain, and embankment components of a bridge-waterway boundary usually comprise different zones of alluvial sediments and soil, as indicated in Figure 2-7. Abutment scour usually occurs within several zones of sediment and soil, leading to different erosion processes and varying rates of erosion.

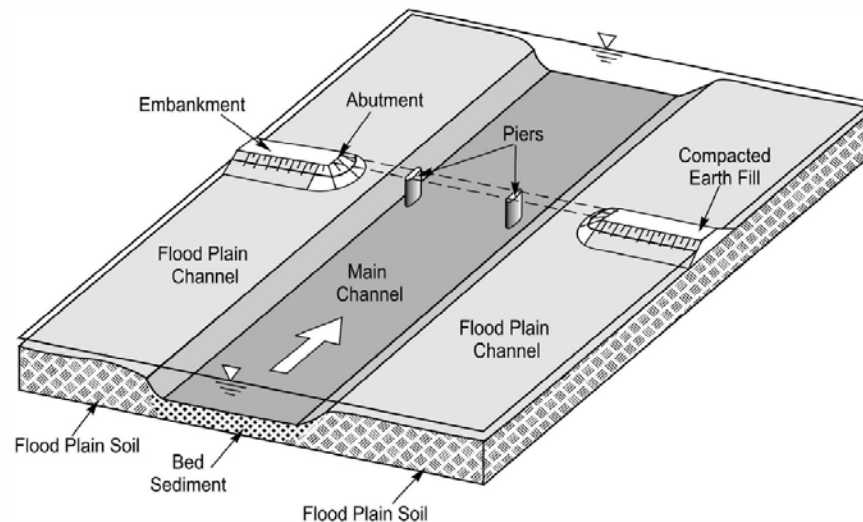

Figure 2-7. Variation of soil and sediment types at a bridge crossing (Ettema et al. 2010).

Alluvial non-cohesive sediment (sands and gravels) most frequently forms the bed of the main channel, whereas the channel's floodplain may be formed from considerably finer sediments (silts and clays), typically causing the floodplain soil to be more cohesive in character than the bed sediment of the main channel. The banks of the main channel usually are formed of the floodplain soils, and thus also may behave cohesively so as to stand at a fairly steep slope.

Most abutments have an earthfill approach embankment formed of compacted soils. The soils may have been excavated from the floodplain or have been brought to the bridge site from elsewhere. The earthfill embankment is placed and compacted to a specific value of shear strength so as to support the traffic load.

Direct, dynamic simulation of the strength behavior of an earthfill embankment or a floodplain soil poses a practical difficulty for laboratory experiments on scour at bridge abutments. The difficulty is to replicate, at a reduced scale, the shear strength of a representative earthfill embankment. To date, no study appears to have attempted experiments that closely replicated the strength behavior of an embankment with mixed soil types.

2.6 FLOW FIELD

Flow through a bridge waterway narrowed by a bridge abutment and its embankment is essentially flow around a short streamwise contraction³. Figure 2-8 schematically illustrates the characteristic flow features and the connection between the contraction and the formation of a complex flow field around the abutments. The flow width narrows and the flow accelerates through the contraction, generating macro-turbulence structures (eddies and various vortices spun from the contraction boundary) that shed and disperse within the flow. Flow contraction and turbulence at many bridge waterways, though, is complicated by the shape of the channel. It is common for waterways to traverse a compound channel formed of a deeper main channel flanked by floodplain channels, as shown in Figure 2-9. To varying extents, all flow boundaries are erodible. As this figure indicates, the major flow features of a short contraction prevail at a bridge waterway comprising a two-lane road. The contraction lengthens for dual-carriageway highways like freeways or expressways.

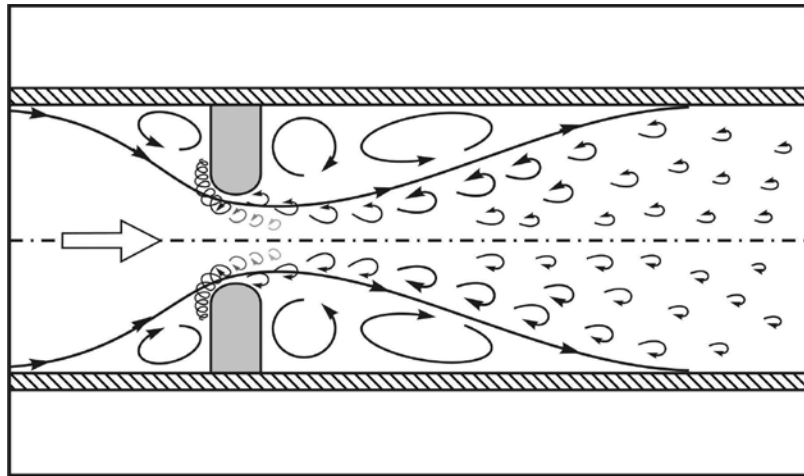

Figure 2-8. Flow structure including macro-turbulence generated by flow around abutments in a narrow main channel. (Ettema et al. 2010).

³ The contraction is short in the streamwise direction

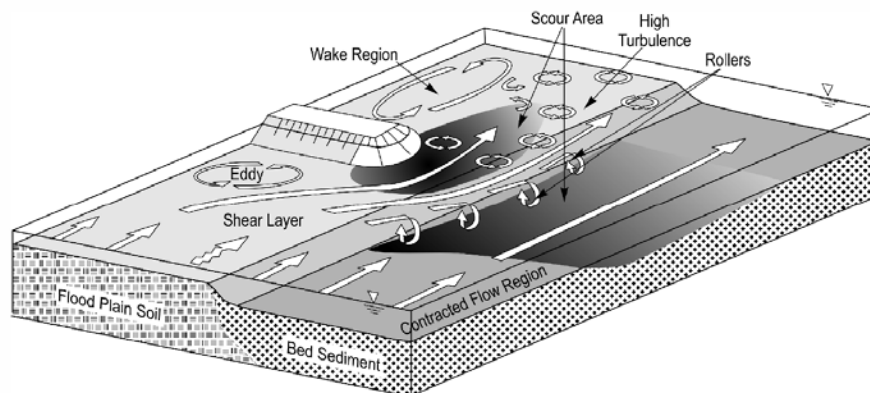

Figure 2-9. Flow structure including macro-turbulence generated by floodplain/main channel flow interaction, flow separation around abutment, and wake region on the floodplain of a compound channel. (Ettema et al. 2010).

Though the short-contraction analogy is somewhat simplistic, an important point to be made is that the flow field around an abutment, like the flow field through an orifice, is not readily delineated as a contraction flow field separate from a local flow field established near the abutment. The two flow features (flow contraction and large-scale turbulence) are related and difficult to separate.

Either of the flow features may dominate, depending on the extent of flow contraction and the characteristics of the abutment and its foundation. When an abutment barely constricts flow through the waterway, scour at the abutment may develop largely due to the local flow field generated by the abutment. This flow field is characterized by a local contraction of flow and by generation of large-scale turbulence. For a severely contracted bridge waterway, flow contraction dominates the flow field and a substantial backwater occurs upstream of the bridge. In this situation, the approach flow slows as it approaches the upstream side of the bridge, and then accelerates to a higher velocity as it passes through the bridge waterway.

When the foundation of the end of an abutment comprises a solid contiguous form extending into the bed (flood plain or main channel), scour development may become similar to that at a wide pier where the flow becomes contracted and large-scale turbulence is produced. Such abutments include situations where a sheet-pile skirt is placed around the toe of the spill-slope of a spill-through abutment (to protect against spill-slope instability and failure), or when a wing-wall column is founded on sheet-piles.

Embankment and abutment structures create potentially erodible short contractions. Higher flow velocities and large-scale turbulence around an abutment may erode the abutment boundary. Commonly, the bed of the main channel is more erodible than the floodplain, because the bed is formed of loose sediment, while the floodplain is formed of more cohesive soil often protected by a cover of vegetation. Accordingly, two prime scour regions typically develop, as borne out by field observations of scour, as indicated in Figure 2-10:

- One region is where the boundary is least resistant to hydraulic erosion. This could be the main bed if flow velocities (and unit discharges) are sufficiently large; and,
- The other region is where the flow velocities (and unit discharges) and turbulence are greatest. This usually is near the abutment.

For the simpler situation of an abutment well set back on a flood-plain, laboratory experiments indicate that deepest scour usually coincides with the region where flow contraction is greatest (Ettema et al. 2010, Melville et al. 2006). Figure 2-11 illustrates this for a spill-through abutment. For spill-through abutments comprising erodible embankments flow contraction dominates the abutment flow field. Once scour begins, the geometry of the bridge waterway (as a short contraction) changes. The deepened flow at the scour region draws more flow, because flow contraction is locally eased there.

The extent and maximum depth of scour at abutments can be complicated by the mix of materials forming the compound channel and the abutment's embankment, and other considerations such as the proximity of a pier.

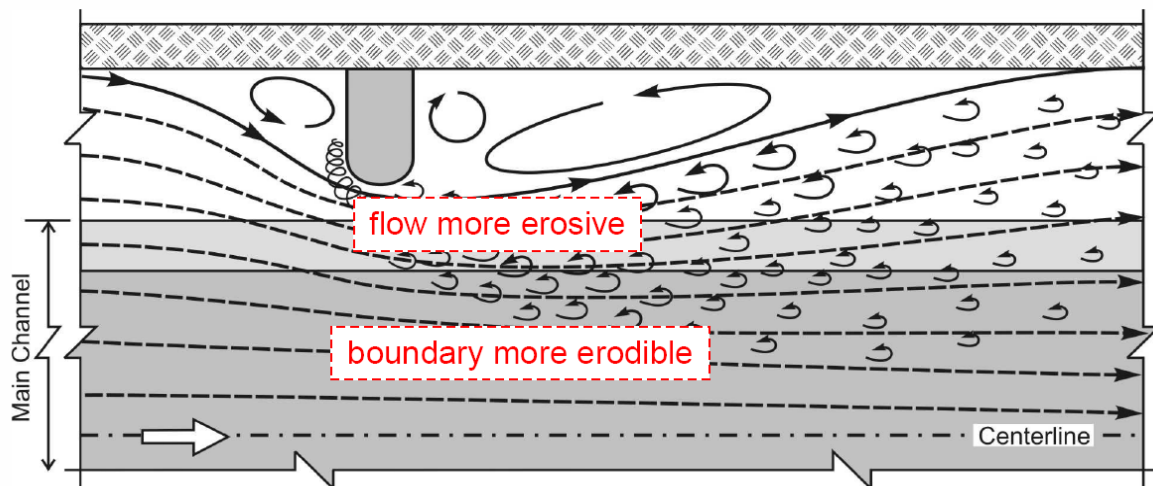

Figure 2-10. Interaction of flow features causing scour and erodibility of boundary (Ettema et al. 2010).

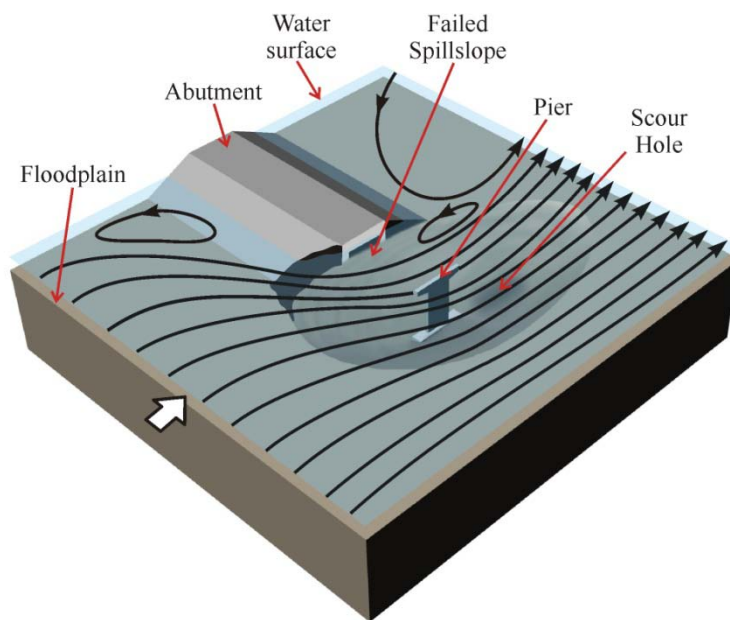

Figure 2-11. For a spill-through abutment well set back on a flood-plain, deepest scour usually occurs where flow is most contracted through the bridge waterway.

CHAPTER 3.

ABUTMENT SCOUR AS A DESIGN CONCERN

The principal design concerns can be expressed in terms of set of questions:

1. What is the greatest scour depth that reasonably could occur near the abutment?
2. Will that scour depth pose a slope-stability problem for the embankment?
3. What scour depth should be used in estimating the required length of pile support?
4. What is the deepest scour that potentially could occur at the abutment column itself?
5. Does that scour occur when the embankment is breached so as to fully expose the abutment foundation?

3.1 DESIGN SCOUR DEPTHS

When considering the possibility of embankment failure, two scour depths must be estimated, in accordance with the design concerns:

1. One scour depth is needed for stable embankment design; and,
2. The second scour depth is required for determining the length of piles underpinning the abutment column, or elevation of column footing (if a footing foundation is to be used).

For design estimation of scour depths, it is necessary to consider the absolute elevations and locations attained by scour. The location of deepest scour relative to the concern of embankment stability differs from that associated with column stability. Additionally, the likely rates or sequences in which the scour develops are important, as explained in Ettema et al. (2010).

3.2 ESTIMATION OF SCOUR DEPTHS

There are several approaches to estimate the two scour depths mentioned in Section 3.1.

Scour depth associated with embankment stability subject to scour can be addressed in two ways, as described below.

1. **Hydraulic then geotechnical calculations.** Estimate the potential maximum depth of scour that may develop without immediately considering the geotechnical failure of the embankment on the floodplain near the abutment. Once this scour depth is estimated, its effect on the geotechnical stability of the main channel bank and embankment can be estimated. If the bank and embankment were found unstable, they would collapse. Failure of the headslope, or spill-slope, is an undesirable condition, which may have most serious consequences if road traffic is not immediately prevented from accessing the bridge approach. The integrity of the abutment column also may be affected by embankment failure, but this may not be the worst case for the column, as discussed below. Embankment failure acts to relieve flow contraction, diminish macro-turbulence generation, and consequently reduce the maximum scour depth attained. The geotechnical strengths of the embankment and floodplain soils, therefore, may

significantly influence abutment scour depth, as well as contribute uncertainty to scour-depth estimation; and,

2. **Geotechnical calculation.** For given (or measured) geotechnical strength properties of the embankment earthfill near the waterway, estimate the maximum limiting steepness for embankment stability. The maximum scour depth attainable then is determined in the context of the limiting maximum steepness of the embankment. No hydraulics calculation is needed, but the position of deepest scour must be estimated. An important point here is that the location of maximum scour depth has substantial bearing on embankment stability and thus the prospect of abutment failure.

Once the embankment fails, flow contraction is relieved, flow area increases, maximum velocity near the abutment diminishes, and scour will not deepen. To be kept in mind, though, is the relative timing of scour development and embankment failure, and the undesirable consequences of full embankment failure.

Scour depth associated with abutment-column stability should be considered in two ways. First, the abutment-column may be rendered unstable due to embankment failure as described above. Secondly, following embankment failure the abutment column may be exposed to the flow in the manner of a pier. This case must rely on a semi-empirical relationship such as used for estimating scour depth at a bridge pier, because an exposed abutment essentially is a pier. The complexity of flow field and sediment movement at a column is practically the same as at a bridge pier.

These design concerns are drawn together in more detail in the NCHRP 24-20 report by Ettema et al. (2010) as a sequence of design steps that take into account abutment location, geotechnical properties of embankment and floodplain, and the erodibilities of main-channel bed and floodplain. Further elaboration of the research needs in this area can be found in Chapter 8.

3.3 AN ESSENTIAL DESIGN QUESTION

An essential design question to be addressed by agencies designing bridge abutments – and not addressed during this evaluation study – concerns how abutment design should best take abutment scour into account. Many experiments and field observations of abutment failure indicate that failure typically occurs as the geotechnical collapse and washout of the abutment’s earthfill embankment. Under severe situations, the abutment column also may fail in a manner similar to scour failure of a bridge pier. Embankment failure may limit the development of abutment scour to a potential maximum depth, because the exposed embankment soil erodes laterally, increasing the flow area and easing flow velocities in the area of deepest scour.

The essential question leads to the following more specific questions:

1. What scour depth(s) should be considered for abutment design (the potential deepest scour, scour leading to embankment failure, or scour at an exposed abutment column)?
2. Is embankment failure (with bridge super-structure remaining intact) acceptable?
3. As the embankment near an abutment column often is a relatively weak or vulnerable location of bridge waterway, what design considerations should be contemplated in order

to strengthen embankments in the vicinity of an abutment column? Then, how would such strengthening affect abutment scour or scour at a nearby pier?

It is noteworthy that all the illustrations of abutment scour in this report show failure of an abutment's earthfill embankment. The example shown in Figure 3-1 is representative of many abutment failures. Another example of embankment failure is shown in Figure 3-2 for a flood in the Atlanta metro area in 2009. Flow coming from the left floodplain as well as overtopping of the bridge severely eroded the left embankment, exposed the abutment and resulted in the approach span to the bridge deck falling into the stream.



Figure 3-1. A common situation of abutment failure; scour has led to failure and partial washout of the earthfill spill-slope at this abutment. A basic question arises as to how abutment design should take scour into account.



Figure 3-2. Failure of abutment fill in September 2009 Georgia flood accompanied by failure of approach roadway (Hong and Sturm 2010).

CHAPTER 4.

SCOUR CONDITIONS

One method for classifying abutment scour depends on abutment location in a channel, the relative erodibilities of sediments forming the main-channel bed and soils forming the floodplain (see Figure 2-10), as well as to the shear strength of the compacted earthfill forming the approach embankment. In addition, other conditions such as stream morphologic changes and lack of control of highway runoff can lead to abutment scour under unexpected and less well-defined circumstances.

4.1 THREE COMMON CONDITIONS OF ABUTMENT SCOUR

Figure 4-1a-c illustrates the three scour conditions for spill-through abutments:

1. **Scour Condition A.** Scour of the main-channel bed, when the channel bed is far more erodible than the floodplain. Figure 4-1a illustrates how scour of the main-channel bed causes the main-channel bank to become geotechnically unstable and collapse. The collapsing bank undercuts the abutment and embankment, which in turn collapses locally. Soil, and possibly riprap, from the collapsed bank and embankment slide into the scour hole;
2. **Scour Condition B.** Scour of the floodplain around the abutment. This condition also is equivalent to scour at an abutment placed in a rectangular channel, if the abutment is set back from the main channel. As the amount of bed-sediment transport on a floodplain usually is quite low, this scour condition usually occurs as clear-water scour. Figure 4-1b shows that the floodplain scours around the abutment, and especially slightly downstream of it. The scour hole locally destabilizes the embankment side slope, causing embankment soil, and possibly riprap, to slide into the scour hole; and,
3. **Scour Condition C.** Scour Conditions A and B may eventually cause the approach embankment to breach near the abutment, thereby fully exposing the abutment column. For this condition, scour at the exposed stub column essentially progresses as if the abutment column were a pier, as illustrated in Figure 4-1c. For the same reasons as given for Condition B, this scour condition usually occurs as clear-water scour.

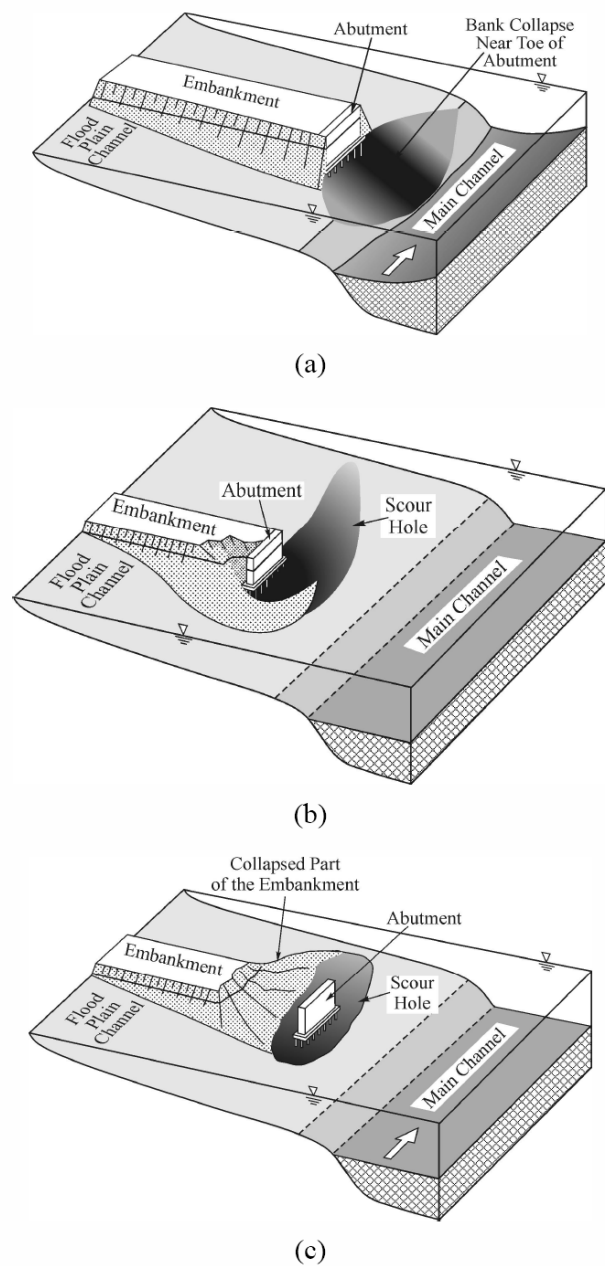

Figure 4-1. Abutment-scour conditions: Scour Condition A - hydraulic scour of the main channel bed causes bank failure, which causes a failure of the face of the abutment embankment (a); Scour Condition B - hydraulic scour of the floodplain causes failure of the face of the abutment embankment (b); and, Scour Condition C - breaching of the approach embankment exposes the abutment column so that scour progresses as if the abutment were a form of pier (c) (Ettema et al. 2010).

The three scour conditions may occur also for wing-wall abutments. However, a couple of additional erosion processes can result in failure of the main-channel bank and the approach embankment:

1. The local flow field generated at the corners of the abutment can cause local scour at those locations; and,
2. Exposure of the piles beneath the abutment pile cap can cause river-bank and embankment soil to be eroded out from beneath the pile cap.

Provided no substantial geotechnical failure of the abutment occurs for scour Conditions A and B, scour deepens to an equilibrium level commensurate with the abutment flow field's capacity to attain a balance with the rate of sediment inflow to the scour region (live-bed scour) or the channel boundary's resistance to erosion (clear-water scour).

A scour event (or series of events) at an abutment, may involve a sequence of all three scour conditions, resulting in several local maxima for scour depth for a wing-wall abutment. When an abutment is close to the main channel, Condition A may develop relatively quickly, with Condition B occurring at a slower rate. Either, or together, Scour Conditions A and B may eventually cause the approach embankment to undergo a slope-stability failure. If the embankment extensively washes out, so as to expose the abutment structure, scour may then develop at the abutment structure as if the abutment were a form of pier (Condition C). Accordingly, an important design consideration is that the stub or wing-wall abutment should not fail when exposed; i.e. foundations of wing-walls should be deep enough that the wing-walls do not fail when exposed to a pier-like scour condition.

For design estimation of scour depth, it is useful to consider the likely rates or sequences in which the three scour conditions developed, and to ask -- What is the greatest scour depth that reasonably could occur near the abutment? Will that scour depth pose a slope-stability problem for the earthfill embankment adjoining an abutment foundation or for the floodplain bank of the main channel? What is the deepest scour that could occur at the abutment column foundation itself, and does that scour occur when the embankment is breached so as to fully expose the abutment column? The set of photographs in Figures 4-2 through 4-4 depict situations where Scour Conditions A, B, and C occurred at bridge abutments.



Figure 4-2. Field example of Scour Condition A.



Figure 4-3. Field example of Scour Condition B.



Figure 4-4. Field example of Scour Condition C for a wing-wall abutment.

4.2 INFLUENCE OF PIER PROXIMITY

The influence of pier proximity on the three scour conditions is slight, at least for the pier form and construction depicted previously in Section 2.5. Flume experiments (NCHRP 24-20) show that abutment scour is dominated by the flow field established by an abutment. Once scour initiates, and deepens below the pier's pile cap, pier presence does not substantially increase flow contraction or the strength of large-scale turbulence structures.

For Scour Condition A at spill-through abutments, pier presence may increase maximum scour depth by approximately 10% when $L_p/W < 2$; where, W = embankment top width and L_p = distance from abutment to pier. The increase results because pier presence close to an abutment slightly increases flow contraction, as flow is deflected around the pier (as if the abutment were lengthened). For Scour Condition B, pier presence acts to increase flow contraction but it also acts to partially block the dispersal of riprap stone. The net influence for Scour Condition B is a lessening of scour depth.

4.3. OTHER SCOUR PROCESSES

Abutment scour may develop consequent to several processes of flow and bed-sediment movement:

1. Localized scour attributable to change in main channel alignment and morphology, which adversely affects abutment location and orientation relative to flow in the main channel. Lateral shift of a channel may direct flow adversely towards abutments not designed for a lateral shift in the channel thalweg. The deeper scour commonly resulting from this possibility must be considered in the scour design of abutments;
2. Scour of the approach embankment flank on the floodplain. This condition may occur when the floodplain flow converging towards the bridge waterway undercuts the flank of

the approach embankment. This scour mechanism differs from those discussed in Chapter 4, and is less common;

3. Erosion along the flanks of an abutment, which may develop because of inadequate control of road drainage along an abutment. Such erosion exposes the earthfill at the end of the abutment, making the abutment more prone to erosion by flow in the main channel; and,
4. Degradation of the main channel bed. This process occurs in response to an overall propensity of the main-channel flow to degrade associated with the reduction in the bed-sediment load along the channel. It also could result from the upstream advance of head-cutting of the channel bed, because the channel has steepened hydraulically. Bank erosion with channel widening may accompany degradation and lead to erosion attack of the embankment.

CHAPTER 5.

SCOUR DEPTH ESTIMATION FORMULAS

Given the complexity of the various scour processes identified in Chapter 4, and the difficulty of including all of those processes in a single empirical formula, it is not surprising that current abutment scour formulas provide scour depth estimates that vary over a wide range of magnitudes. Furthermore, comparisons of abutment scour depth estimations from existing formulas with field data and with engineering experience can produce mixed results partly because of the misperception that abutment scour formulas apply to all types of abutment scour, even to the most complicated field situations, and partly due to the difficulty of estimating the flow and sediment parameters required in existing scour formulas. It is the purpose of this chapter to present several leading abutment scour formulas, classify them, assess their limitations, and evaluate their usefulness in various types of abutment scour cases.

5.1 PARAMETER FRAMEWORK

While dimensional analysis provides a convenient starting point for building a framework of parameters on which abutment scour formulas depend, the specific parameter influences are somewhat less clear than in the case of pier scour. Nevertheless, identification of groups of dimensionless parameters that are used in different scour prediction formulas provides a context for classifying and assessing the applicability of the formulas. Some of the major variables affecting abutment scour in a compound channel are defined in Figure 5-1. A dimensional analysis of these variables leads to the following set of parameters:

$$\frac{Y_2}{Y_1} = \phi \left[\frac{u_{*1}}{u_{*c}}, \frac{V_1^2}{gY_1}, \frac{\rho V_1 L}{\mu}, \frac{L}{d}, \frac{L}{Y_F}, \frac{W}{Y_F}, K_s, K_\theta, \frac{L}{B_f}, \frac{B_f}{B_{m1}}, \frac{B_{m2}}{B_{m1}}, \frac{Y_F}{Y_1}, \frac{k_F}{k_m}, \frac{\sigma}{\gamma_E H_E} \right] \quad (5.1)$$

in which Y_2 = maximum depth of flow after scour in the short contraction presented by the bridge; Y_1 = upstream approach flow depth in main channel; Y_F = upstream approach flow depth in the floodplain; L = length of the abutment/embankment; B_f = width of the floodplain; B_{m1} and B_{m2} = width of the main channel in the approach flow section and the bridge section, respectively; W = width of the embankment in the flow direction; d = some measure of the sediment size forming the erodible boundary such as the median size by weight, d_{50} ; ρ and μ = density and viscosity of the fluid, respectively; V_1 = approach flow velocity; u_{*1} and u_{*c} = shear velocity of the approach flow and the critical value of shear velocity for initiation of sediment motion, respectively; k_F and k_m = roughness height of the floodplain and main channel, respectively; K_s = shape factor of the abutment as it affects scour by the flow field; K_θ = embankment skewness factor as it affects scour; g = acceleration of gravity; σ = bulk shear strength of the embankment fill; γ_E = bulk density of the embankment material; and, H_E = height of the embankment.

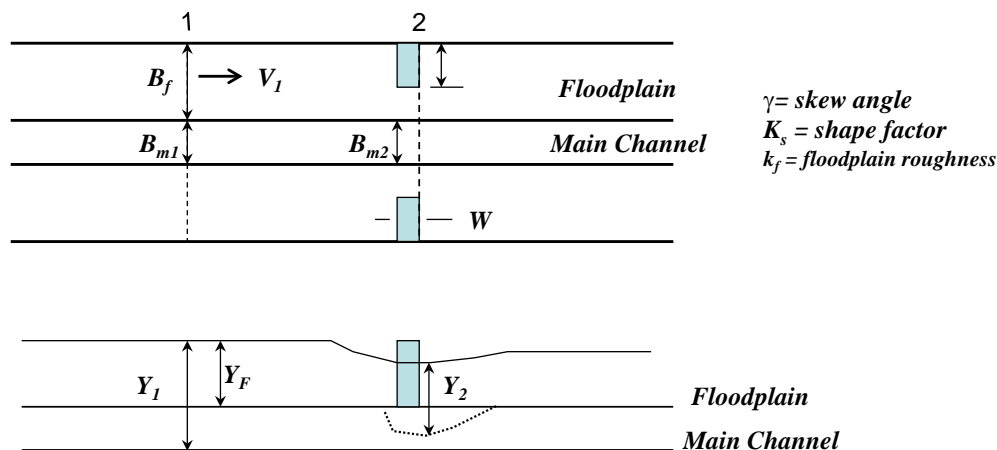

Figure 5-1. Definition sketch for abutment terminating in a compound channel.

This dimensional analysis does not fully include other scour influences identified in the previous chapter that are less amenable to quantification, such as changes in channel alignment and morphology; erosion of the abutment flank due to flow convergence or drainage; bed degradation due to anthropogenic or natural causes, and heterogeneity of sediments comprising floodplain and main channel.

Major groups of dimensionless parameters affecting abutment scour are identified in Table 5-1. These parameter groups tend to overlap. For example, the relative roughness of the floodplain and main channel affect not only the flow distribution as Group G4 parameters, but also influence the magnitude of the flow intensity factors in Group G1 as a consequence. It could be argued that the Group G2 parameter is also a Group G1 parameter in so far as the abutment/embankment length represents some measure of the size of turbulent flow structures.

Alternative formulations of the flow intensity factor in Group G1 are also possible such as

$$Flow\ Intensity \approx \frac{V_1}{u_{*c}} \text{ or } F_d = \frac{V_1}{\sqrt{(\rho_s / \rho - 1)gd}} \tag{5.2}$$

in which ρ_s = density of the sediment; and F_d = sediment number or densimetric grain Froude number. While the numerical values of such parameters are not the same, they measure the ratio of the velocity causing transport to a reference velocity scale associated with initiation of particle movement. The critical shear stress is preferred for characterizing the threshold of sediment motion because it depends only on sediment properties. Critical velocity, on the other hand, depends both on critical shear stress and depth of flow; it can be calculated from Manning’s equation or Keulegan’s equation for fully-rough turbulent flow. For transitional or smooth turbulent flow, an expanded equation is needed (see Sturm 2009). Applying a measured critical velocity from a laboratory flume directly to the field can lead to serious errors.

Table 5-1. Classification of abutment scour parameters.

Dimensionless Parameter Groups	Parameter Names	Parameter Group	Influences	Comments
u_{*1}/u_{*c} or V_1/V_c , $V_1/(gY_1)^{0.5}$, $\rho V_1 L/\mu$	Flow intensity, Froude number, Reynolds number	G1. Flow/Sediment	Stage of sediment transport; effect of gravity on water surface profile; effect of flow separation & bed roughness	Flow intensity indicates flow interaction with the sediment and can be used to classify clear-water vs. live- bed scour
L/d	Relative sediment size	G2. Abutment/Sediment scale	Unclear, but may be related to model scaling issue	Generally not included in abutment scour formulas
L/Y_F , W/Y_F , K_s , K_θ	Floodplain aspect ratio; relative contraction length, abutment shape and skewness factors	G3. Abutment/Flow geometry	Measures abutment dimensions relative to scale of flow field, and shape and orientation of abutment relative to flow field	Abutment scour formulas classified by Melville according to value of L/Y_F
$\frac{L}{B_f}$, $\frac{B_f}{B_{m1}}$, $\frac{B_{m2}}{B_{m1}}$, $\frac{Y_F}{Y_1}$, $\frac{Y_F}{k_f}$, $\frac{k_f}{k_m}$	Abutment, channel and flow length scales	G4. Abutment Flow distribution	Taken together, these parameters can be translated into discharges per unit width in the flow approach and contracted sections	Discharge contraction ratio or q_{f2}/q_{f1} determined by these parameters
$\sigma/(\gamma_E H_E)$	Abutment stability parameter	G5. Scour/Geotechnical Failure	Scour that leads to slope instability	Difficult to model in the laboratory

Of the parameter groups listed in Table 5-1, the geotechnical stability parameter is particularly difficult to determine. While strict quality controls may be followed during construction, the mixture of soil materials comprising the embankment may be very site specific and difficult to quantify relative to erosion resistance. Scour gradually causes removal of the toe and subsequent geotechnical instability of the entire fill. In addition, the Group G4 hydraulic parameter that quantifies the change in flow distribution from the approach flow section to the bridge section conveniently encompasses the influence of many geometric length ratios, but it is nonetheless challenging to evaluate, especially with one-dimensional numerical models. In the bridge section itself, the flow contraction is not always fully developed because it is abrupt and relatively short in the flow direction so that significant streamline curvature exists. Under these circumstances, a two-dimensional model for setback abutments on wide floodplains, or even a three-dimensional model for bankline abutments may be necessary to quantify the flow distribution at the bridge section. Finally, it is paramount to have as much information as possible on the sediment itself both in the floodplain and in the main channel, and over soil formation depths commensurate with the abutment foundation depth. Spatial heterogeneity of soils and their erosion resistance is the rule rather than the exception, and a scour resistant layer can be underlain by a very erodible

layer or vice-versa. Fine-grained materials are often found in the river banks and floodplains while sand and gravel may form the erodible boundary of the main channel. The interparticle forces associated with fine-grained soils make evaluation of their erosion resistance particularly challenging.

In some states, abutment scour countermeasures may be required as a matter of course for all abutments. Riprap aprons, concrete aprons, and guide banks are especially useful, and guidelines have been developed for their design. In the case of riprap aprons, for example, the rock size and blanket thickness, and the lateral extent of the riprap apron as it wraps around the spill-through abutment can all be specified, as can the extent of a concrete apron (Barkdoll et al. 2007, Melville et al. 2006a, b). Scour is moved to the edge of the riprap apron, and even if a portion of the apron erodes, it serves to protect against further abutment scour in the immediate vicinity of the abutment. There is a danger, however, in assuming that an apron protects an abutment from failure for all discharges. The scour hole may be moved into regions that are more easily scoured and may interact with adjacent pier scour holes depending on their proximity. For this reason, abutment scour formulas must be further developed for cases of riprap aprons in place as well as for those without such countermeasures.

Channel morphologic changes are a major concern with respect to abutment scour, but they cannot be conveniently quantified in Table 5-1 nor have abutment scour formulas been developed for this case because of its complexity. River meanders gradually migrate downstream by transporting sediment from the outside of the bend to a point bar at the beginning of the next meander loop. As the outer meander loop boundaries translate laterally they can intersect the abutment and cause failure. The meander loop can also be cut off during a flood leading to a completely new channel path that endangers the bridge abutments. Braided streams are even more unpredictable as multiple channels form and interconnect thereby leaving island deposits and new flow pathways that unexpectedly form and expand in the lateral direction with each new flood. Prevention of abutment failures due to these morphologic changes requires close consultation between the hydraulic engineer and a fluvial geomorphologist such that bridge abutments are located well outside any meander belts or braided stream paths.

5.2 SUMMARY OF ABUTMENT SCOUR FORMULAS

Table A-1 of Appendix A presents several abutment scour formulas in an approximately chronological order of publication. In some cases, later refinements of formulas by the same researchers are grouped together. Some of the earliest contributions to the problem of abutment scour estimation were related to research on scour around spur dikes by Garde et al. (1961) and Gill (1972), while Liu et al. (1961) reported the results of extensive flume studies on vertical wall, wing-wall and spill-through abutments in large flumes. These formulas prominently feature the scour depth nondimensionalized by the flow depth as a function of Froude number and the geometric width contraction ratio or the ratio of abutment length to flow depth.

Laursen applied the early Straub (1934) solution for equilibrium sediment transport in a long contraction to abutments using his own sediment transport formula for the live-bed case. He assumed that abutment scour was some multiple of the theoretical long contraction scour. Laursen's (1960, 1963) formulas and Gill's (1972) formula are similar and are all based on the

solution to the idealized long rectangular contraction. The principal difference lies in the contraction ratios used; Gill used the full channel contraction ratio (approach channel width divided by bridge opening width), whereas Laursen used an assumed contraction width equal to the estimated scour hole width, resulting in the contraction ratio $= (2.75d_s + L)/2.75d_s$, where d_s is scour depth below the undisturbed bed level.

Sturm and Janjua (1994) introduced the idea of replacing the geometric contraction ratio with the discharge contraction ratio M for characterizing the change in flow rate per unit width caused by an abutment ending on the floodplain of a compound channel. This formula was further refined in Sturm (2004, 2006) by applying the relationship for the Laursen long contraction such that the independent variable became q_{f2}/q_{fc} in which $q_{f2} \approx q_{f1}/M$ and q_{fc} = critical floodplain velocity times the depth in the contracted bridge section of a compound channel. Extensive experiments were conducted for various abutment lengths on a wide erodible floodplain including both setback and bankline abutments. Three sediment sizes were used, and wingwall, spill-through and vertical abutments were included in the experiments. The abutments were constructed as solid-wall structures and so the results are applicable to sheet-pile foundations and other conditions for which the abutment stub and embankment are not subject to undermining.

Chang and Davis (1998, 1999) presented an abutment scour methodology called ABSCOUR which has been further developed by the Maryland State Highway Administration (MSHA 2010). ABSCOUR treats abutment scour as an amplification of contraction scour. For clear-water scour, the reference contraction scour is estimated by a form of the Laursen contraction scour formula as q_{f2}/V_c and adjusted by an abutment shape factor K_s , an embankment skewness factor, K_θ , a velocity correction factor K_v , and a spiral flow correction factor K_f . In addition, the methodology includes an adjustment/safety factor that is based on the user's assessment of risk and whether the floodplain is narrower or wider than 800 ft (244 m) (Benedict 2010, MSHA 2010). The velocity correction factor varies with q_{f1}/q_{f2} based on potential flow theory while the spiral flow factor is intended to account for turbulence effects and is related to the approach flow Froude number based on laboratory data (Palaviccini 1993, MSHA 2010). The method is also applied to live-bed scour. The full ABSCOUR 9 computer program/methodology includes procedures to refine discharge and velocity distributions and channel setback distances under the bridge; evaluate scour in layered soils; consider the effect of pressure scour; evaluate the slope stability problem for the embankment; consider degradation and lateral channel movement and other specific concerns. The program is used to integrate contraction, abutment and pier scour and to draw a scour cross-section under the bridge (MSHA 2010).

Extensive experimental work at The University of Auckland by Melville (1992, 1997) resulted in a comprehensive approach to estimating abutment scour that was integrated with earlier pier scour formulas. The Melville approach accounts not only for abutment length in ratio to flow depth but also for effects of flow intensity, bed armouring, abutment shape and orientation, relative sediment size, and channel geometry as separate multiplicative factors obtained from experiments that were conducted primarily in rectangular channels. Melville (1992) showed that his formula for maximum clear-water scour at an intermediate-length, vertical-wall abutment in a rectangular channel agrees with Laursen's abutment scour formula. The data obtained by Cardoso and Bettess (1999) and Fael et al. (2006) have verified that the Melville formula provides an envelope relationship for the depth of clear-water scour at a vertical-wall abutment

in a rectangular channel for $L/B < 0.4$, where B is channel width. Lim (1997) and Lim and Cheng (1998b) have derived abutment scour formulas for clear-water and live-bed scour, respectively, in a rectangular channel. They assume that the flow rate through the scour hole area is the same before and after scour. Their clear-water scour formula agrees with the Melville formula and the Laursen abutment scour formula for the special case of an intermediate-length, vertical-wall abutment in a rectangular channel.

The live-bed abutment scour formula developed by Froehlich (1989) and the HIRE equation are suggested in HEC-18 (Richardson and Davis 2001). Froehlich's equation is derived from regression analysis applied to a list of dimensionless variables using laboratory data from Liu (1961), Gill (1972), and the Auckland data among other sources. The HIRE equation is based on field scour data for spur dikes in the Mississippi River obtained by the U.S. Army Corps of Engineers.

Oliveto and Hager (2002, 2005) conducted extensive experiments on vertical-wall abutments in rectangular channels referred to as the VAW data set from ETH Zurich. They proposed a reference length scale for abutment scour depth to be $(Y_1 L^2)^{1/3}$ and used the sediment number (or densimetric grain Froude number), F_d , which was described in section 5.1, as the primary independent dimensionless ratio; however, their proposed formula also includes a dimensionless time so that scour depth can be estimated at different times of scour hole development. Kothyari et al. (2007) further refined this relationship by expressing it in terms of the densimetric grain Froude number written in the form $(F_d - F_{dc})$, in which F_{dc} = the critical value of F_d at the beginning of scour. Furthermore, an estimate of the time to "end-scour" conditions is given in terms of F_d .

The essential notion underlying the scour prediction methodology proposed by Ettema et al. (2010, Project NCHRP 24-20) is that the potential maximum flow depth near an abutment due to scour can be expressed in terms of an amplified contraction scour estimated as a function of unit-discharge values for flow around an abutment. The maximum scour depth, Y_{MAX} , is given as $Y_{MAX} = \alpha Y_C$, in which Y_C is the mean flow depth of the contraction scour, and α is an amplification factor whose value varies in accordance with the distribution of flow contracted through the bridge waterway, and on the characteristics of macro-turbulence structures generated by flow through the waterway. Two estimates of αY_C should be considered:

1. Amplification of long-contraction scour; and,
2. Amplification of local scour estimated on the basis of the flow contracted locally around an abutment in a channel so wide that flow does not contract through the bridge waterway.

The value of α should be assessed for flow contraction in the main channel (Scour Condition A) and/or near the abutment (Scour Condition B). Abutment shape, along with the aspects of channel morphology and roughness that affect flow through the bridge waterway, influence the amplification coefficient, α . The ensuing limits apply to α :

1. When the bridge waterway is contracted only locally around an abutment, and contraction scour is negligibly small in the waterway, α is large. Its value depends on the

local contraction of flow passing immediately around the abutment, and the turbulence structures generated by the abutment; and,

2. For a severely contracted bridge waterway, α diminishes to a value slightly above 1. At this limit, the bridge creates a substantial backwater effect that impounds water. The bed shear exerted by highly contracted flow is much larger than the erosive forces exerted by turbulence structures generated by the abutment. In some ways, such extreme contraction is similar to scour at a bottomless culvert.

In developing relationships for estimating the scour depths incurred with Scour Conditions A and B, it is convenient to adapt and extend Laursen's well-known methods for estimating live-bed contraction scour (Laursen 1960), and for clear-water contraction scour (Laursen 1963). His methods are useful for directly identifying the main parameters associated with abutment scour, though they neglect the influence of macro-turbulence. Other contraction-scour methods could certainly be used. The proposed formulation assumes live-bed scour conditions for flow in the main channel, and clear-water scour conditions for flow over the floodplain. The relationships apply to scour of cohesive as well as non-cohesive bed and floodplain boundaries. It is noted that slightly different relationships are given for Scour Conditions A and B.

An important consideration in the method proposed by Ettema et al. is the need to take into account the actual manner in which most abutments are constructed; i.e., as an abutment column set amidst an earthfill embankment whose length varies widely in accordance with site conditions. Consequently, geotechnical failure of the embankment is an important aspect of abutment scour, and may limit its development. Geotechnical failure is not a desirable condition, but it occurs frequently for abutments, sometimes leading to flow breaching of the earthfill embankment at abutments as shown previously in Figures 3-1 and 3-2. Ettema et al. also propose a geotechnically based approach for estimating scour depth. This approach is not reliant upon the need to estimate a critical value of erosion resistance for the boundary around an abutment. The approach requires instead an estimate of the geotechnical strength of the earthfill embankment at the bridge waterway. Also, Ettema et al. give a relationship for estimating Scour Condition C, scour depth at an exposed abutment column.

A further consideration in choosing abutment scour formulas is the case of predicting scour depth and possible embankment failure when armor protection and an apron have been applied to an embankment. Van Ballegooy (2005) conducted an extensive set of experiments concerning riprap and cable-tied-block (CTB) protection at spill-through and wing-wall abutments. The findings are presented in Melville et al. (2006a, 2006b), as well as in Van Ballegooy (2005).

For spill-through abutments, it is shown that armor protection (including apron protection) acts to deflect the scour development a sufficient distance away from the abutment toe that damage is prevented. With increasing toe protection (i.e. increasing apron extent), the scour hole at spill-through abutments sited in the flood channel typically is deflected further away from the abutment and reduces in size. However, for abutment and compound channel configurations where the scour hole forms close to the main channel bank, the scour hole can increase in size as the apron extent is increased. CTB mats allow scour holes to form closer to the abutment, compared to scour holes at abutments protected by equivalent riprap aprons, and result in deeper scour holes. It is axiomatic that wider apron protection is needed to give a certain level of

protection, when using CTB compared to riprap aprons. Equations are given to predict the scour depth for spill-through abutments, situated on the flood plain of a compound channel, and the minimum apron width to prevent undermining of the toe at spill-through abutments. A design methodology is proposed for evaluation of the stability of spill-slope fill material at spill-through abutments in terms of the extent of apron protection, and is presented in Melville et al. (2006a, 2006b) and Van Ballegooy (2005).

For wing-wall abutments, it is shown that the scour under mobile-bed conditions is directly related to the level of the deepest bed-form trough that propagates past the abutment, which is predictable using existing expressions, together with any localized scour that may occur (Melville et al 2006a, 2006b, and Van Ballegooy 2005). Stones on the outer edge of riprap aprons tend to settle and move away from the abutment pushing the erosion zone further away from the abutment. Conversely, CTB mats remain intact during settlement. The outer edge of the apron settles vertically, allowing the scour to occur closer to the abutment face than for an equivalent riprap apron. Equations are given for prediction of the minimum apron width remaining horizontal after erosion. These predictions, together with prediction of apron settlement, facilitate assessment of the stability of an abutment structure.

Briaud et al. (2009) have developed a formula for abutment scour in a compound channel with pure porcelain clay as the sediment and with solid abutments. Experiments were done in a compound channel and a rectangular channel. The ratios of flow depth in the floodplain to that in the main channel, however, were greater than 0.5 so that compound channel effects on the velocity distribution were minimal. The main channel velocity never exceeded the floodplain velocity by more than about 10%. Each experiment was run for more than 10 days, and the abutment scour holes developed usually at the toe of the abutment on the downstream side. The scour formula developed from the data indicates that the maximum abutment scour depth depends on the difference between 1.57 times a flow Froude number near the toe of the abutment and a critical value of the flow Froude number, where “critical” refers to initiation of scour. The reference velocity in the Froude number is determined as the mean velocity in the bridge opening for bankline abutments, and as the mean velocity of the upstream floodplain flow if it were to pass entirely through the floodplain in the contracted section for set-back abutments. The physical significance of Froude number alone when formulating a relationship for scour depth seems somewhat problematic when scour is dominated by flow separation and macroturbulence. Froude number effects are often neglected for small values (considerably less than one); the approach flow Froude numbers in the experiments were of the order of 0.25. It is interesting that the resulting scour formula for cohesive sediments underpredicted the scour data of Sturm (2006) while overpredicting the scour in the database used by Froehlich (1989) in noncohesive sediments; that is, the cohesive sediment scour depths stayed within the bounds of those measured for noncohesive sediments for solid abutments.

The maximum scour depth formula by Briaud et al. is part of a larger procedure that involves testing a sediment sample in a pressurized duct flow to determine erosion rate as a function of shear stress (erodibility curve). The critical shear stress is taken as the hydrodynamic stress corresponding to a very low erosion rate of 0.1 mm/hr. The maximum shear stress before scour at an abutment is estimated based on a Reynolds number that uses the mean approach velocity as the velocity scale and the width of the abutment as the length scale. For this maximum shear

stress, the initial erosion rate is determined from the erodibility curve. Then the maximum scour depth and initial erosion rate are substituted into a standardized hyperbolic time development curve to obtain the scour depth for a specific duration of storm, or for a specified time history of flow taken over the life of the bridge.

5.3 CLASSIFICATION OF SCOUR FORMULAS

Because existing scour formulas apply to different types of abutment scour situations and rely on different classes of basic parameters on the one hand, and may not apply at all to some cases of abutment scour such as those due to stream morphology changes on the other hand, it is worthwhile to classify the formulas in several different ways. Furthermore, it is imperative that abutment scour formulas not be applied outside the range of variability of the basic dimensionless parameters for which they were derived. In carrying out such a classification exercise, it may be possible to develop a hierarchical approach in which classes of scour formulas are first matched with the type of abutment scour to be expected in a given project, then tested against the range of dimensionless parameters to be experienced in the field, and finally accepted or rejected on the basis of their applicability. In some instances, and especially if more adverse consequences and a resultant higher risk are involved relative to possible bridge failure by scour, it may become clear that no existing formula is acceptable. In this case, combinations of numerical and hydraulic modeling may be needed. In addition, abutment scour formulas that apply when scour countermeasures such as abutment riprap aprons are in place may be required as discussed in the section on further research.

5.3.1. Classification by Parameter Groups

Most of the abutment scour formulas presented in Table A-1 utilize dimensionless parameters from one or more of the groups of parameters in Table 5-1. All formulas except those based only on vertical-wall abutments incorporate a shape and orientation factor from Group G3 parameters in Table 5-1. Only the procedure by Ettema et al. (2010) has suggested a geotechnical parameter such as in Group G5 in the table. Ettema et al. argue the importance of considering how abutments are built. A risk in comparing the formulas is that some formulas are developed for quite different abutment structures. Practically all the formulas developed prior to Ettema et al. are based on models that assume abutments to be pier-like structures extending as solid forms deeply into the bed or floodplain of a channel such as would be the case for sheet-pile foundations. The vast majority of abutments are built as earthfill embankments at or surrounding a pier-like abutment column.

Formulas are placed into categories in Table 5-2 according to the dominant parameter groups from Table 5-1 that are incorporated into them. A major category of formulas (**C1**) includes L/y_1 from Group G3 and some flow parameter such as F_1 , and/or F_d or V_1/V_c from Group G1. This category includes the formulas by Laursen, Liu, Froehlich, Melville, Lim, Cardoso and Bettess, and Fael et al. which were developed primarily from experiments in rectangular laboratory flumes with relatively short abutments. Note that the live-bed scour formulas in this group tend to include F_1 , while the clear-water scour formulas incorporate V_1/V_c or a similar parameter. As argued by Laursen, the live-bed case is based on equilibrium sediment transport rate, not the relative stage of incipient sediment motion in the approach flow as for clear-water scour. These

formulas essentially treat abutments as a “half pier” for small value of L or as a wide pier in shallow flow for larger values of L .

Table 5-2. Formulas categorized by parameter groups.

Formula Category	Parameter Group				
	G1 Flow/Sed	G2 Abut/Sed	G3 Abut/Flow Geometry	G4 Abut/Flow Distribution	G5 Scour/Geotech Failure
C1 Laursen, Liu, Froehlich, Melville, Lim, Cardoso & Bettess, Fael et al.	X		X		
C2 Oliveto & Hager, Kothyari et al., Briaud et al.	X				
C3 Garde et al., Liu, Gill, Sturm, Chang & Davis, Ettema et al.	X			X	
C4 Ettema et al.					X

The formulas by Oliveto and Hager (2002), and by Kothyari et al. (2007) are in a related but second category (**C2**) because of the inclusion of the sediment number, or densimetric Froude number, from Group G1 parameters, while the abutment length and flow depth are combined into a reference length scale to nondimensionalize scour depth rather than appearing separately as L/y_1 from Group G3. The appearance of a dimensionless time in this category of formulas also sets them apart from the first category. The Kothyari et al. (2007) formula introduces $(F_d - F_{dc})$ as the primary independent parameter; that is, an excess value of F_d relative to a critical value akin to a sediment transport formula even though it is intended for clear-water scour. However, the critical value is estimated at the contracted section from the geometric contraction ratio so that $F_d > F_{dc}$. The formula by Briaud et al. (2009) for maximum scour depth might also be placed in this second category only because it is based on an excess value of the flow Froude number relative to a critical value in the contracted section. The abutment length appears in this formula only as an abutment location correction for abutments very close to the bank of the main channel.

A third category of formulas (**C3**) is one that uses some measure of the flow contraction caused by the bridge (Parameter Class G4). Formulas by Garde et al., Liu, and Gill are for rectangular channels and contain a geometric contraction ratio. The formula by Sturm replaces the geometric contraction ratio with a discharge contraction ratio, which is more appropriate for compound

channels, to obtain the discharge per unit width in the contracted section in ratio to its critical value, q_2/q_c . The scour methodology of Chang and Davis (1998, 1999) utilizes q_2/q_1 as an independent variable for live-bed scour and q_2/V_c for clear-water scour. Ettema et al. directly employ the ratio q_2/q_1 and embed the effect of V/V_c in the reference contraction scour depth for the clear-water case. Ettema et al. also use the live-bed contraction scour as a reference length for live-bed abutment scour in the main channel (Scour Condition A) for bankline abutments. A significant difference in the data obtained by Ettema et al. is that it was taken for an erodible abutment/embankment instead of a rigid one which sets this formula apart from the others in this respect. In addition, their unique methodology for evaluating hydraulic scour and geotechnical failure in a combined design process has been identified as Parameter Class G5 in Table 5-2.

5.3.2. Classification by Channel Type and Bridge Crossing

When considering scour at bridge abutments, a diverse range of situations is possible based on the geomorphic type of channel that a bridge must cross. The following three classes of bridge crossings encompass most actual cases and provide a useful classification. First, the description of each type of crossing is given, and then abutment scour formulas appropriate for each class are given.

1. Class I: Shorter crossings over incised channels

Class I refers to narrower bridge crossings of incised channels, where the channel is reasonably well represented by a rectangular channel. This class also includes narrow crossings for conditions up to bank-full flows. Some examples are shown in Figure 5-2.

At Class I bridge crossings, bridge foundations may be single or multiple span. The bridge abutments are typically located at the channel bank. From the perspective of abutment scour analysis, many such sites can be considered to have essentially no flood channels. Vertical wall abutments, with or without wing-walls, are common. The abutment column may be founded on piles, or a slab footing, in which case undermining of the abutment structure by scour is a common type of failure. Alternatively, a protective wall (e.g., sheet-piling) may be constructed below the abutment structure, effectively extending the non-erodible abutment surface deeper into the underlying bed material. Outflanking of the abutment column, due to lateral channel migration and/or flow skewness at the abutment, is also common.

2. Class II: Wider crossings over compound river channels

Class II refers to wider bridge crossings, where the channel is typically compound, comprising a main channel and wide flood channels. At such sites, significant flows may be diverted from the flood channels towards the main channel at the bridge section. Some examples are shown in Figure 5-3.



(a)



(b)

Figure 5-2. Bankline abutment in a narrow channel.



(a)



(b)

Figure 5-3. Bridge crossing for a compound channel.

At Class II bridge crossings, bridge foundations are typically multi-span. The bridge abutments are usually located on the flood channels, and may be near to the main channel bank or set back from it. From the perspective of abutment scour analysis, such sites exhibit significant flow diverted from the floodplain towards and into the main channel at the bridge section. Spill-through abutments, with or without countermeasure protection to the embankment slopes and toe, are common. Toe protection may be a protective apron or sheet-pile protection, or equivalent. The abutment column may be founded on piles, or a slab footing, in which case undermining of the abutment structure, due to slope failure initiated by scour at the toe of the embankment by scour, is the common type of failure.

3. Class III: Wider crossings over braided river channels

Class III refers to bridges spanning wide braided river channels, where the river channel can be approximated by a rectangular channel under extreme flood flow conditions. At such sites, the bridge foundations may be significantly skewed to the flow at lesser flood flow conditions. An example is shown in Figure 5-4.

At Class III bridge crossings, bridge foundations are usually multi-span. The bridge abutments may be located at the channel bank or extend into the channel. In the latter case, significant flow contraction may occur. Spill-through abutments, with or without countermeasure protection to the embankment slopes and toe, are common. Toe protection may be a protective apron or sheet-pile protection, or equivalent. The abutment column may be founded on piles, or a slab footing, in which case undermining of the abutment structure, due to slope failure initiated by scour at the toe of the embankment by scour, is the common type of failure.



Figure 5-4. Bridge crossing of a braided channel.

Class I and Class III are the simplest situations to model in the laboratory and many of the existing laboratory data apply to these two classes which can be modeled approximately as rectangular channels. It is important to recognize, however, that nearly all known data in these two classes were collected using rigid abutment models extending below the maximum measured scour depth. Equations derived from such data give the “maximum possible” scour depth that can occur and should then be conservative for design. Such equations are not suitable for prediction of scour depths that develop where undermining of the pile cap or slab footing occur, because slope failure may then limit further scour.

The following equations in Table A-1 may be considered applicable for estimation of “maximum possible” scour depths at non-erodible abutments/embankments at Class I and Class III crossings:

- *Liu et al. (1961)*
- *Garde et al. (1961)*
- *Laursen (1960, 1963)*
- *Gill (1972)*
- *Froehlich (1989)*
- *Melville (1992, 1997)*
- *Lim (1997, 1998b)*
- *Oliveto and Hager (2002, 2005)*
- *Fael et al. (2006)*

If the abutment/embankment structure is erodible, then the formula by Ettema et al. (2010) is also applicable to this case and would correspond to Scour Conditions A and C.

Class II crossings are the most difficult to predict because of the interaction between the main channel and floodplain flows and the resultant redistribution of the flow in the contracted bridge section depending on how much of the floodplain flow is blocked by the embankment. As a result, Class II crossings are further sub-classified according to the three scour types identified by Ettema et al. and discussed in the following section.

5.3.3. Classification by Scour Condition in Class II Compound Channel

The following three scour conditions can occur in a Class II compound channel as described in more detail in Section 4.1. They were classified by Ettema et al. (2010) and lead to abutment scour being defined on a continuum of relative importance of local flow constriction due to the abutment versus channel-wide flow contraction as a result of increasing lengths of the embankment.

- **Scour Condition A.** Scour of the main-channel bed, when the floodplain is far less erodible than the bed of the main channel. This condition can lead to instability of the main channel bank and the abutment embankment which collapse into the scour hole. This scour condition is usually live-bed scour in the main channel.
- **Scour Condition B.** Scour of the floodplain around the abutment. This condition can be equivalent to scour at an abutment placed in a rectangular channel, if the abutment is set back far enough from the main channel, but the distance required is not well defined. As the amount of bed-sediment transport on a floodplain usually is quite low, this scour condition usually occurs as clear-water scour. For an erodible embankment, it can be undercut and fail by collapsing into the scour hole.
- **Scour Condition C.** Scour Conditions A and B may eventually cause the approach embankment to breach near the abutment, thereby fully exposing the abutment column. For this condition, scour at the exposed stub column essentially progresses as if the abutment column were a pier. For the same reasons as given for Condition B, this scour condition usually occurs as clear-water scour.

To these three scour conditions, a fourth might be added:

- **Scour Condition AB.** This condition is a combination of A and B in which the floodplain as well as the embankment is erodible, and the scour hole on the floodplain can extend into the main channel.

The following equations in Table A-1 may be considered to apply to Class II crossings, with boundary material as specified:

- *Cardoso and Bettess (1999) – rigid, with relatively narrow flood channel*
- *Melville (1992, 1997) - rigid*
- *Van Ballegooy – erodible with protection*
- *Ettema et al. – erodible*
- *Richardson and Davis (2001) – HIRE equation, based on field data*
- *Laursen – rigid*
- *Briaud – rigid (clay)*
- *Sturm - rigid*

5.4. EVALUATION OF ABUTMENT SCOUR FORMULAS

From the foregoing classifications of existing abutment scour formulas, it appears that no single formula can apply to all possible cases of abutment scour, and in fact, none of the equations apply to the more difficult geomorphic transformations characteristic of meandering and braided streams. Nevertheless, it is useful to evaluate existing formulas in order to identify those that may provide promise and direction or even a framework for future research. For this purpose, the following criteria were established for evaluating abutment scour formulas:

1. *Adequacy in addressing parameters that reflect important physical processes governing abutment scour;*
2. *Limitations of formulas in design applications with respect to ranges of controlling parameters on which they are based;*
3. *Categorization and acceptability of laboratory experiments and research methods that led to the development of the formula (e.g., experimental duration, variety of particle sizes and types of sediments, realistic geometries and scales, characterization of flow field, degree of idealization, large database)*
4. *Attempts to verify and compare formulas with other lab data and field data, if any, with which a valid comparison can be made;*
5. *Applicability and ease of use for design (notably, as recommended in AASHTO Standard Specifications for Highway Bridges)*

5.4.1. Parameter Groups

With respect to parameters included in an abutment scour formula, it was shown in Section 5.3.1 how different parameters can be used to reflect the same physical process such as the approach flow conditions in clear-water scour. Parameters that utilize critical velocity as opposed to critical shear stress must include the flow depth because velocity alone is insufficient to characterize the propensity to transport sediment and generate scour.

Abutment scour formulas that were developed from experiments in rectangular channels must be used very carefully in compound channel flow. The geometric contraction ratio does not properly represent the flow contraction effect in a compound channel. Furthermore, the abutment must be set well back on the floodplain from the main channel in order to apply a rectangular channel formula; or more precisely, the amount of floodplain flow blocked by the embankment must be small in comparison to the total flow. Thus, geometric criteria based on the values of L/B_f and B_f/B_m are useful, but they may not be sufficient. In addition, the floodplain flow depth relative to the main channel depth is an important criterion to consider in terms of the degree of interaction of floodplain and main channel flows. Interactions become less important as $Y_f/Y_1 > 0.5$. A discharge contraction ratio is a better measure of the flow redistribution from the floodplain to the main channel as the bridge opening is approached.

The geotechnical parameter measuring embankment stability does not appear explicitly in any of the formulas, but the procedure recommended by Ettema et al. includes a check of embankment stability in addition to predicting the depth of scour. Finally, the inclusion of d_{50} as the sole measure of grain stability is conservative in that it does not account for the armoring effect. For pure clays, grain size is not necessarily the correct parameter to determine critical shear stress although it may be important in some coarser soil mixtures.

5.4.2. Limitations and Databases of Abutment Scour Formulas

The ranges of dimensionless parameters to which several abutment scour formulas apply are given in Table 5-3. The dependent parameter of d_s/Y_1 is related to Y_2/Y_1 as $Y_2/Y_1 = d_s/Y_1 + 1$ only if the change in velocity head and the head loss between the approach flow and contracted sections can be neglected. This is generally true only if the flow is decidedly subcritical; that is, if the Froude number is relatively small. Backwater effects can also become important at higher values of the undisturbed approach flow Froude number as embankment length increases.

The classification scheme of Melville (1992) based on L/Y_1 is useful in comparing the applicable ranges of different abutment scour formulas:

$0 < L/Y_1 < 1$	<i>Short abutments similar to pier obstructions</i>
$1 < L/Y_1 < 25$	<i>Intermediate length abutments</i>
$25 < L/Y_1$	<i>Long abutments</i>

Only a few of the formulas in Table 5-3 include experiments with abutments in the “long” category. This classification scheme should be accompanied by one that measures the flow distribution between floodplain and main channel in compound channels; B_f/B_m and L/B_f are not quite sufficient in this regard as discussed in Section 5.4.1.

It is important to distinguish between clear-water scour and live-bed scour because the required parameters are different as discussed previously. Only a few formulas are applicable to both cases. The Melville formula accomplishes this by using a different function for the flow intensity factor in clear-water and live-bed scour, while the formulation by Ettema et al. is referenced to a contraction scour depth that is computed by different principles for the two cases.

Table 5-3. Limitations and experimental databases of abutment scour formula.

METHOD	Dependent Variable	Primary Independent Variables.	LIMITS	CMPD. -C RECT. -R	CLEAR WATER; LIVE-BED	d_{50} mm	Time hr
Garde et al. (1961)	d_s/Y_1	F_1 , $m = (B - 2L)/B$	$0.1 < F_1 < 0.4$ $0.5 < m < 0.9$	R	CW	0.2, 0.45, 1.0, 2.25	3-5
Liu et al. (1961) CSU	d_s/Y_1	$F_1, L/Y_1$	$0.3 < F_1 < 1.2$ $1 < L/Y_1 < 10$	R	LB	0.56	5-150
Liu et al. (1961) CSU	d_s/Y_1	F_1, m	$0.1 < F_1 < 0.6$ $0.5 < m < 0.9$	R	CW	0.56, 0.65	--
Laursen (1963)	d_s/Y_1	$L/Y_1, u^*/u_{*c}$	Liu (CSU) data	R	CW	--	--
Gill (1972)	d_s/Y_1	$Y_1/d, m$, τ_c/τ_1	$20 < Y_1/d < 90$ $0.6 < m < 0.9$	R	CW, LB	0.9, 1.5	6
Froehlich (1989)	d_s/Y_1	$K_s, K_\theta, F_1, L/Y_1, Y_1/d$, σ_g	Liu, Garde, Gill, Auckland data	R	CW	--	--
Froehlich (1989)	d_s/Y_1	$K_s, K_\theta, F_1, L/Y_1$	Liu, Garde, Gill data	R	LB	--	--
Melville (1992) (1997), Melville and Coleman (2000)	d_s/Y_1	$K_s, K_\theta, L/Y_1, L/d, \sigma_g$, $V_1/V_c, K_G$	$1 < L/Y_1 < 69$ $0.7 < V_1/V_c < 6.4$	R, C	CW, LB	0.9	50-200
HIRE(2001)	Y_2/Y_1	K_s, K_θ, F_{ab}	$L/Y_1 > 25$	C	LB		Field
Lim (1997) (1998)	d_s/Y_1	L/Y_1 , u^*/u_{*c}	Gill, Liu, Cunha, Auckland	R	CW LB		
Cardoso & Bettess (1999)	d_s/Y_1	L/B_f , Y_f/B_f	$0.2 < L/B_f < 1$ $3 < L/Y_1 < 20$ $B_f/B_m = 0.5$ $0.4 < Y_f/Y_1 < 1.0$	C	CW	0.84	6-120 (T_{eq})
Sturm (2004, 2006)	d_s/Y_1	$K_s, q_{fl}/(Mq_{oc})$ where $M = (Q - Q_{obst})/Q$ $q_{oc} = V_c Y_{fd}$ $q_{fl} = V_{fl} Y_{fl}$	$12 < L/Y_1 < 80$ $0.17 < L/B_f < 1$. $0.2 < Y_f/Y_1 < 0.5$ $B_f/0.5B_m = 6.7$ $0.26 < M < 0.90$	C	CW	1.1, 2.7, 3.3	20-60
Maryland Chang & Davis (1998, 1999), MSHA (2010)	d_s	$K_s, K_\theta, q_2/q_1, F_1$ $K_s, K_\theta, q_2/V_c, F_1$	Compared with Sturm (2004) lab data in HEC-18; SC field data in Benedict (2010)	R, C R, C	LB CW	--	--
Oliveto & Hager (2002, 2005)	d/d_R $d_R = (L_a^2 Y)^{1/3}$	F_d, σ, T	$1.5 < F_d < 3.7$	R	CW	0.6-5	6-330
Fael et al. (2006)	d_s/Y_1	$(\rho_s/\rho - 1), L/Y_1$	$9 < L/Y_1 < 36$ $V_1/V_c \approx 1.0$ $L/B < 0.4$	R	CW	Quartz – 1.3 Pumice – 1.2	20-120
Ettema et al. (2010)	Y_2/Y_c	A: $q_2/q_1, \alpha$ B: $q_2/q_{fl}, \alpha$ $\alpha = \text{amplification}$	$0.2 < L/B_f < 2$ $0.23 < B_f/0.5B_m < 1$	R, C	LB CW	0.45	4-24
Briaud et al. (2009)	d_s/Y_1	$(1.57 F_2 - F_c)^{0.7}$	$0.5 < L/B_f < 1$ (Compound) $0.28 < L/B < 0.75$ (Rectangular) $3 < L/Y_1 < 8$ $0.48 < Y_f/Y_1 < 0.67$ $B_f/0.5B_m = 2$	R, C	CW	Porcelain clay	320

The duration of scour experiments has been discussed extensively in the literature. In general, live-bed scour experiments approach an equilibrium state, albeit with fluctuating bedforms, in a relatively short period of time compared to clear-water scour which only approaches equilibrium in an asymptotic manner. Formulas have been developed for estimating the time to equilibrium for abutment scour (Coleman et al. 2003). The result differs with flow intensity and the relative shallowness of the flow blocked by the embankment. The time to reach equilibrium in the experiments of Briaud et al. (2009) on pure clay is exceedingly long because of the time required to break the inter-particle bonds of the clay structure.

Some of the formulas in Table 5-3 are based on a relatively small number of experiments, while others have a robust database that includes wide ranges in values of the various independent parameters. The experimental databases of Liu et al. (1961), Melville (1992, 1997), Sturm (2004, 2006), Oliveto and Hager (2002, 2005) and of Ettema et al. (2010) include large numbers of scour experiments, for example.

5.4.3. Comparisons of Abutment Scour Formulas

To evaluate abutment scour formulas, it is necessary to compare the scour predictions of leading formulas with experimental data of other studies, provided that the comparisons are made for similar ranges of the governing parameters. Comparing a live-bed abutment scour formula with clear-water abutment scour data is not necessarily valid, for example. In addition, it must be recognized that comparisons between scour data for erodible abutments and foundations versus solid abutments and sheet pile foundations will likely produce different results, but in this case, it may be informative to explore how much different the scour depth predictions are with all other factors being equal.

Comparisons of various abutment scour formulas must also take into account the inherent uncertainty in the data and the confidence limits of the formulas. The study by Sturm (2004), for example, shows that most of the data fall within limits of $\pm 25\%$ of the best-fit relationship for maximum scour depth. Similarly, Oliveto and Hager (2002, 2005) report limits of $\pm 30\%$ for their extensive data set, although their comparisons for dimensionless scour depth include dimensionless time as an additional independent variable.

Abutment scour data at a spill-through abutment in a laboratory compound channel are compared in Figures 5-5 and 5-6 with predictions from the formulas proposed by Sturm (2004, 2006) and Melville and Coleman (2000, also see Melville 1997) in Figures 5-5 and 5-6, respectively. For the abutments considered, riprap protection extended below the level of the floodplain so that the abutment was less likely to erode. Reasonable agreement between the data and the Sturm formula is shown in Figure 5-5. In Figure 5-6, the envelope lines given by Melville and Coleman are in good agreement with the data when the scour hole is located on the floodplain but underestimate the data for a scour hole extending from the floodplain into the main channel. It could be argued that the Melville and Coleman (2000) formula applies to a setback abutment for shallow flow in a wide floodplain, because it does not explicitly include the effect of flow contraction.

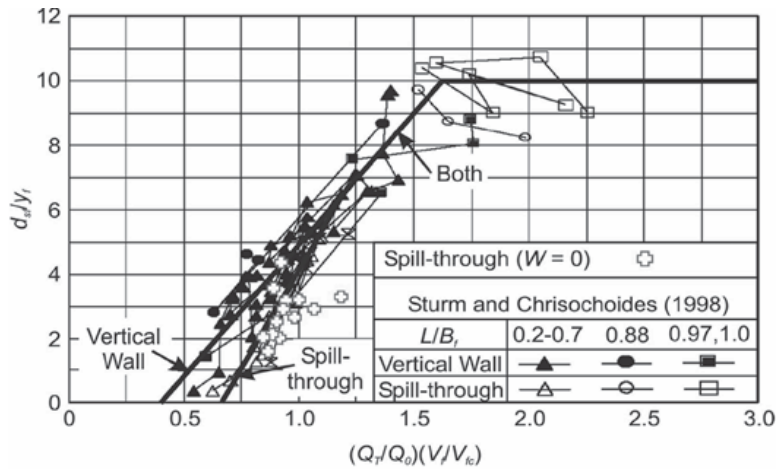

Figure 5-5. Comparison between scour data at a spill-through abutment (with riprap protection extended below the surface of the floodplain) and the formula by Sturm and Chrisochoides (1998a, see also Sturm 2004, 2006). Reproduced from NCHRP Report 587 by Barkdoll et al. (2007).

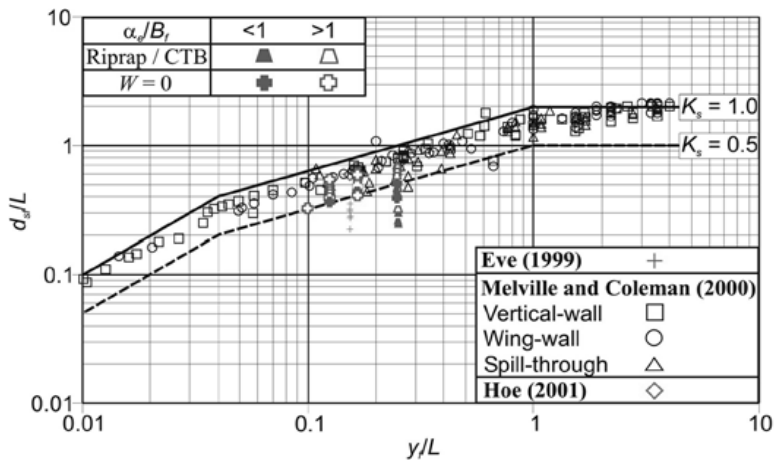
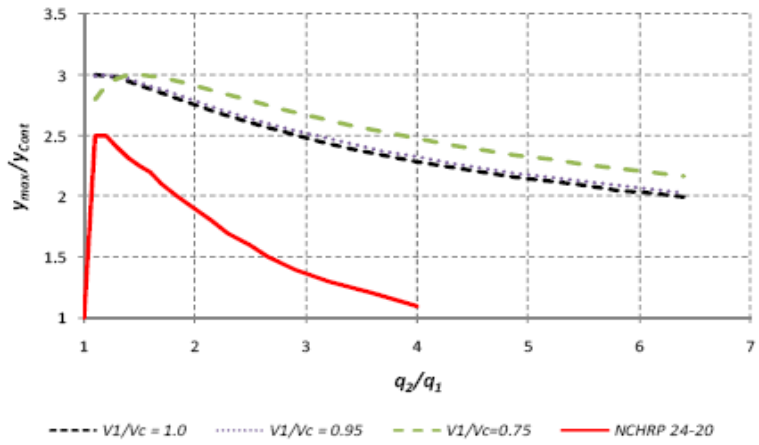

Figure 5-6. Comparison between scour data at a spill-through abutment (with riprap protection extended below the surface of the floodplain) and the formula by Melville and Coleman (2000, essentially the same formula as proposed by Melville, 1997). Reproduced from NCHRP Report 587 by Barkdoll et al. (2007).

Ettema et al. (2010) have compared their data with the ABSCOUR formula for clear-water abutment scour depth (Chang and Davis 1999, MSHA 2010). Although both approaches use contraction scour depth as a reference depth, Ettema et al. concluded that there are significant differences in the adjustment factors in the two formulas. ABSCOUR includes a velocity adjustment K_v , which is given as a function of q_1/q_2 and is derived for potential flow, and a spiral flow adjustment K_f determined as a function of approach flow Froude number. On the other hand, the Ettema et al. adjustment factors for flow concentration and turbulence are combined into one factor given in a design curve as a function of q_2/q_1 . As a result, the asymptote of Y_{Max}/Y_C in ABSCOUR for large values of q_2/q_1 tends to be controlled by the value of K_f and thus the Froude number, while the design curve by Ettema et al. approaches a value of unity as abutment scour becomes increasingly dominated by channel flow contraction. Although the ABSCOUR methodology limits the values of K_f to a range of 1.0 to 1.4, the laboratory studies by Kerényi et al. (2007) on bottomless culverts show that K_f is not a function of Froude number. Likewise, application of the Maryland formula to the field clearwater abutment scour data of Benedict (2003) shows that the spiral flow factor appears to have no statistically significant dependence on Froude number (Benedict 2010).

Briaud et al. (2009) have compared their method for prediction of maximum scour depth with the data envelopes developed by Ettema et al. (2010) for erodible embankments in Scour Condition B as shown in Figure 5-7. Briaud et al. assumed a rectangular channel and made calculations from their formula for three velocity ratios ($V_1/V_c = 1.0, 0.95, 0.75$) and for a spill-through as well as wing-wall abutment. Good agreement is obtained at the peak of the Ettema et al. curve for the spill-through abutment, but for both abutment shapes, the Briaud et al. formula shows a more gradual decrease in Y_{MAX}/Y_C with q_2/q_1 . At $q_2/q_1 = 4$, the Briaud et al. formula predicts a relative abutment scour depth that is approximately 2.5 times greater than the Ettema et al. value for wing-wall abutments and approximately 1.8 times greater for spill-through abutments. In large part, the difference can be attributed to the difference in model abutments used. Briaud et al. use a pier-like abutment whose solid body extended at depth into the boundary. As scour developed at such an abutment, flow can entrench around the solid abutment form. Ettema et al. use erodible abutments prone to failure as scour deepens. An important consideration in the development of scour is the strength of the earthfill embankment.



(a) Wing-Wall shape abutment

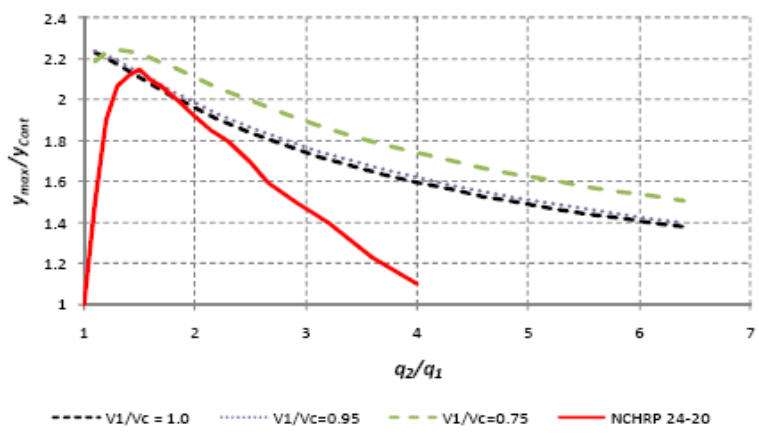

(b) Spill-Through abutment

Figure 8.5 – Comparison with NCHRP 24-20 (2008).

Figure 5-7. Comparison of Briaud et al. (2009) formula with experimental results of Ettema et al. (2010) for Scour Condition B. [Reproduced from Briaud et al. (2009). Final design curves are Figs. 12.3 and 12.4 of the NCHRP 24-20 report by Ettema et al. (2010)]

The abutment scour formula of Melville (1992, 1997) and the abutment scour data from Sturm (2004, 2006) are shown in Figure 5-8 in comparison with the data from Ettema et al. (2010) for Scour Condition B. The Melville formula is plotted on these axes by using the Laursen assumption that the flow contraction takes place at the end of the abutment in a flow width of $2.75d_s$. Experiments show that this width is actually variable; a flow width of $3.5d_s$ is shown in the figure for a slightly better correspondence with the data, but the main purpose here is only to place into perspective the Melville formula and the Sturm data, which are both for solid abutments with sheet pile foundations, relative to the Ettema et al. data for a riprap-protected embankment on an erodible floodplain. The reference to “long” and “intermediate” length abutments in the figure is according to the classification by Melville (1992). The data from Sturm (2006) have been adjusted to apply for $V_1/V_c = 1.0$ in agreement with the Melville curves

shown in the figure. It is interesting to note that both the Melville formula and the Sturm data for Y_{MAX}/Y_C follow the same trend of an increase to a maximum relative scour depth followed by a gradual decrease as q_2/q_1 increases. The peak occurs at $q_2/q_1 = 1.5-2$ in comparison to a value of 1.25 from the Ettema et al. data. The most useful insight is perhaps that the maximum value of Y_{MAX}/Y_C for the solid abutment with sheet pile foundation is approximately 6.5 in comparison with the Ettema et al. value of 2.5 for a riprap-protected but erodible embankment. Evidently, the manner of abutment construction plays an important role in the development of scour and the depth attained. It would appear that the solid abutment holds the vortex system in place relative to the abutment with scour progressing downward unimpeded by riprap rolling into the scour hole and limited in horizontal extent by deposition downstream. The scour depths indicated by the Sturm (2004, 2006) data and Melville (1997) curves provide an upper limit because they apply to a solid abutment while conceivably embankments of greater strength or more conservative riprap design than in the Ettema et al. experiments could be represented by intermediate curves in Figure 5-8. This is a matter for further research.

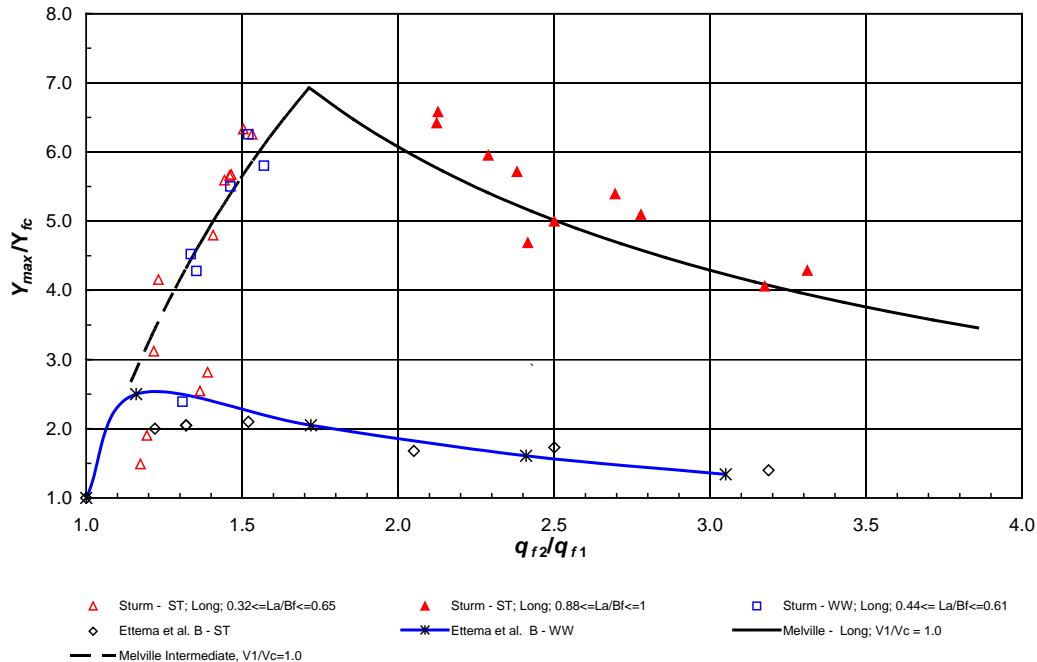

Figure 5-8. Comparison of Melville (1997, also Melville and Coleman 2000) formula and Sturm (2004, 2006) data for rigid abutments with Ettema et al. (2010) data for erodible embankments and Scour Condition B.

Ettema et al. (2010) have further considered the limiting cases of an abutment approaching zero length in a floodplain of fixed width versus an abutment of fixed length in a floodplain of increasing width as shown in Figure 5-9. In the latter case, the limiting condition is a scour depth that is greater than the contraction scour depth because it is governed by the local turbulence and flow separation associated with the abutment obstruction and flow concentration alone. Further research is needed to define this limiting case.

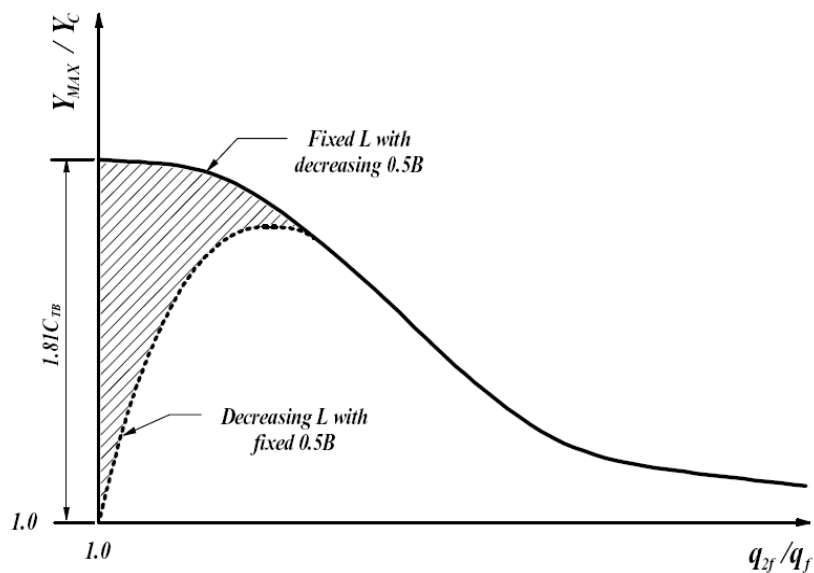

Figure 5-9. Scour depth trends for Scour Condition B. (Ettema et al. 2010).

Comparisons between leading scour formulas and field data are more challenging than for the laboratory case. Mueller and Wagner (2005) compared measured contraction and abutment scour depths in the field with predictions from formulas recommended by HEC-18 and concluded that the formulas do not account for the complexity of flow conditions in the field. Comparisons by Wagner et al. (2006) between abutment scour formulas and field data generally showed large overpredictions by several abutment scour formulas including those by Froehlich, Sturm, and the HIRE equation. In some cases, the formula by Sturm predicted abutment scour depths that agreed with the field data within the $\pm 25\%$ uncertainty of the formula, most notably on the Pomme de Terre River in Minnesota, while predictions were excessive on the Minnesota River near Belle Plaine, Minnesota. In the latter case, a skewed crossing with two small radius meanders immediately upstream of the bridge resulted in a very complex flow field (see Figure 5-10). In other cases, the field data included silt or silty sand with some clay content at the bridge crossing which makes the estimation of critical velocity a challenge. Unfortunately, such complex field situations are not uncommon.



Figure 5-10. Minnesota River near Belle Plaine, MN for 2001 flood. (Wagner et al. 2006).

Other important issues to be considered when comparing abutment scour formulas with field data are the different mechanisms associated with scour at abutments. Besides considerations of embankment strength, time of measurement of scour, and location of maximum scour depth, abutment scour often is associated with lateral shifting of the approach channel.

Comparisons between measured post-flood scour depths at bridges in South Carolina with several abutment scour formulas have been reported by Benedict et al. (2007). In most cases, the hydraulic variables used in the scour formulas were assumed to be those calculated for the 100 year flood without knowledge of the actual flow conditions that caused the scour. In a smaller number of cases, measured flood discharges were available. Excessive abutment scour depth estimates were given by the Sturm formula due in part to the fact that critical velocities were estimated by the equation given in HEC-18, which is valid only for coarse sediments. Approximately two-thirds of the sediment samples at the South Carolina sites, especially in the Piedmont, were fine-grained sediments exhibiting cohesive characteristics according to the classification by Benedict et al. (2007). In further examination of the sensitivity of estimated scour depths to critical velocity, Benedict (2010) concluded that significant errors in existing scour prediction formulas, when compared to field data, may occur because of poor definition of this parameter. In addition, the long time duration required to reach equilibrium scour in cohesive soils calls into question the advisability of direct comparisons of predictions of equilibrium scour formulas developed for coarse-grained soils with scour data for cohesive soils.

5.4.4. Ease of Use of Abutment Scour Formulas

Ease of use of abutment scour formulas is a function of how easily and how accurately the important parameters can be estimated. The critical velocity or shear stress is of paramount concern in clear-water scour formulas, while the estimate of flow-field parameters such as velocity and discharge per unit width in the approach flow and in the contracted bridge section are important in both clear-water and live-bed scour. In the former case, relationships for critical velocity may be misapplied, and so further education is needed in this regard; however, the inescapable inference is that better methods are needed with respect to making initial estimates of critical velocity or critical shear stress in the case of fine-grained sediments. Adequately characterizing the required flow-field parameters for any of the abutment scour formulas that have been discussed is also a challenging problem. One-dimensional methods such as HEC-RAS leave much to be desired, but they are preferred with respect to rules of thumb in estimating flow distribution at a bridge, for example. Two-dimensional methods require experienced users for calibration and can be an improvement to 1D methods in the hands of experienced users. For the case of a bankline abutment, even 3D methods with standard turbulence models are available now.

The difficulty of estimating critical shear stress/velocity and flow-field parameters responsible for scour makes it unlikely that any one scour formula holds any advantage over others in terms of ease of use and accuracy of application. In fact, the estimation of representative values for these two classes of parameters is a limitation of all the methods discussed.

5.5 GEOTECHNICAL APPROACH

Given the difficulty of applying abutment scour formulas and the rather common geotechnical failure of the embankment, an additional consideration might be to use the geotechnical approach to scour estimation along with the leading abutment scour formulas. One point of view is that methods based solely on hydraulic considerations give “potential scour depths” in the absence of embankment failure. Often, as evident in the field, the abutment embankment fails before the potential depth is attained.

A direct geotechnical estimate entails the following considerations (Figure 5-11):

1. Embankment failure back to the abutment column defines maximum scour depth; failure opens the flow area, relieves flow; and,
2. Determination of values of internal resistance angle, θ_s , of the embankment and floodplain materials.

Further details are given by Ettema et al. (2010).

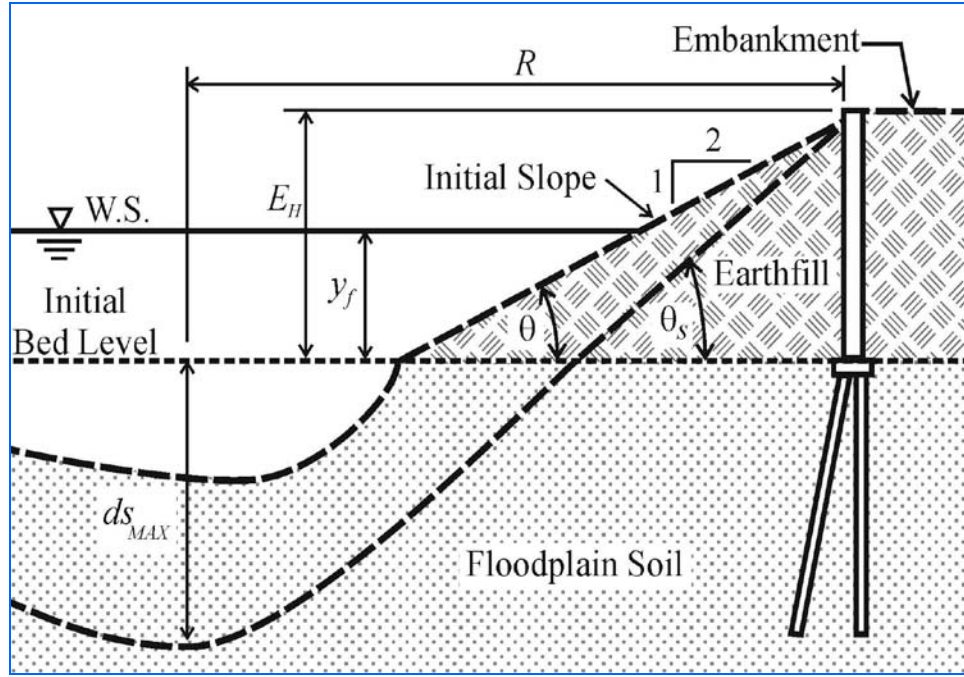

(a)

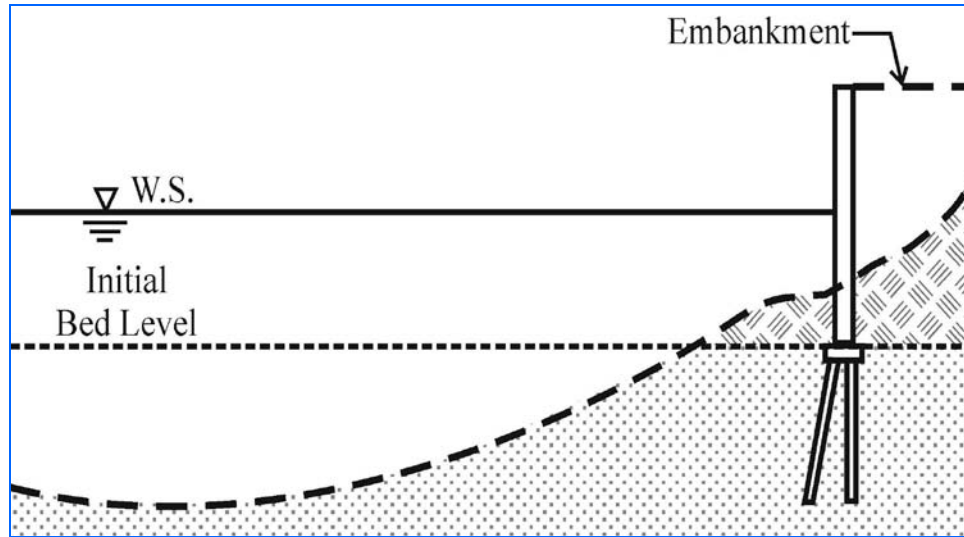

(b)

Figure 5-11. Scour depth estimation based on geotechnical stability of embankment; (a) variables, (b) failure of embankment past abutment column relieves flow so that maximum scour depth is attained (Ettema et al. 2010).

CHAPTER 6.

CONTRACTION SCOUR FORMULAS

6.1 DEFINITION OF CONTRACTION SCOUR

Contraction scour is caused by flow acceleration due to narrowing of the channel cross section whether by natural reduction in the width of the main channel for a bankline abutment, or by redistribution of floodplain flow in the contracted section as a result of flow blockage by the bridge embankment for a setback abutment. Although contraction scour will vary across the cross section in the field due to nonrectangular geometry and a nonuniform velocity distribution, it is often visualized and applied as a uniform decrease in bed elevation across the bridge opening. Floodplain contraction scour is usually treated separately from main channel contraction scour in compound channels. In this case, one of the difficulties in applying a contraction scour formula is the determination of the discharge distribution between the floodplain and the main channel in the bridge section.

Both live-bed and clear-water contraction scour can occur in the field. The former commonly occurs in the main channel of a sand-bed river, while the latter is more likely to be found in a floodplain contraction or a relief bridge located on the floodplain. Contraction scour formulas have been developed analytically for an idealized long contraction as will be described subsequently. In the case of live-bed contraction scour, the limiting condition is continuity of sediment transport between the approach-flow section and the contracted section. For clear-water scour, the governing principle is that the depth of scour in the contracted section corresponds to the occurrence of critical velocity there as the scour approaches its equilibrium state.

6.2 DIMENSIONAL ANALYSIS

Dimensional analysis provides a useful approach for evaluating contraction scour formulas. The approach is similar to that given in Section 5.1 for abutment scour. With reference to Figure 6-1, the dimensional analysis for contraction scour can be written as

$$\frac{Y_2}{Y_1} = \varphi_2 \left(\frac{u_{*1}}{u_{*c}}, \frac{(V_1)^2}{gY_1}, \frac{\rho V_1 Y_1}{\mu}, \frac{B_1}{d}, \frac{B_1}{Y_1}, \frac{B_1}{B_2}, \frac{L_c}{B_2}, M, \sigma_g \right) \quad (6.1)$$

in which Y_2 = maximum depth of flow after contraction scour; Y_1 = upstream approach flow depth; B_1 = width of approach flow channel; B_2 = width of contracted section; L_c = length of contraction (streamwise); d = some measure of the sediment size; ρ and μ = density and viscosity of the fluid, respectively; V_1 = approach flow velocity; u_{*1} and u_{*c} = shear velocity of the approach flow and the critical value of shear velocity for initiation of sediment motion, respectively; g = acceleration of gravity; M = discharge ratio dependent on flow redistribution between main channel and floodplain; and σ_g = geometric standard deviation of sediment size distribution.

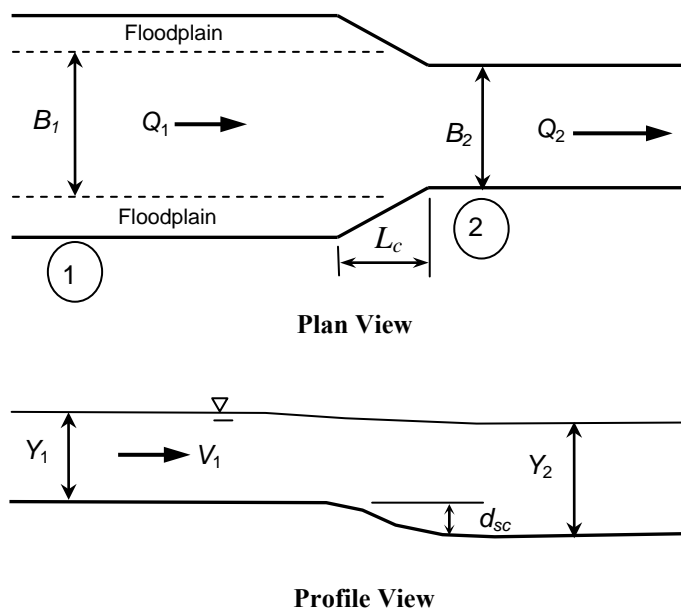

Figure 6-1. Definition sketch for idealized long contraction scour (Q_1 = main channel flowrate for live-bed scour; Q_2 = total flowrate in channel at contracted section; d_{sc} = contraction scour depth).

The first term on the right-hand side of Equation (6.1) can also be written as a ratio of shear stresses, τ_1 / τ_c , since $u_* = (\tau/\rho)^{1/2}$. This ratio is less than or equal to unity for clear-water contraction scour, while it plays no role in live-bed contraction scour which is governed by sediment transport continuity. The second term is the Froude number squared which reflects the influence of the drop in the water surface due to flow acceleration; it is important for larger values but is often neglected for smaller values. The third term is the flow Reynolds number which incorporates viscous effects, but it can be neglected for the large values typical of prototype turbulent flow. The fourth and fifth ratios define the relative sediment size and the aspect ratio of the approach flow, respectively, and can be neglected except in very small scale laboratory experiments. The ratio of channel widths, B_1/B_2 , is a very important dimensionless ratio that determines the amount of geometric contraction of the flow and thus the degree of contraction scour. The discharge contraction ratio M is discussed below, and σ_g accounts for armoring in well-graded sediments. The parameter L_c/B_2 expresses relative contraction length, which may affect the location of maximum contraction of flow and, thereby, scour development (this aspect of abutment scour has yet to be studied).

All of the floodplain and main channel geometric and roughness characteristics from Equation (5.1) have been replaced in Equation (6.1) with a single discharge distribution factor, M , that differs based on whether the flow is main channel flow only or a compound channel flow, and whether the contraction scour can be classified as live-bed or clear-water. In the case of live-bed contraction scour, it will be shown below from the Laursen equation that for overbank flow with a contraction caused by a bankline abutment, $M = Q_{1\text{main channel}} / Q_{2\text{total}}$. If, on the other hand, live-

bed contraction scour occurs for flow in the main channel only, the value of M is unity but B_1/B_2 becomes the primary independent variable gauging the degree of flow contraction as determined by main-channel geometry alone.

Because clear-water contraction scour tends to occur only on the floodplain, the effective B_1/B_2 can be replaced by the ratio of discharges per unit width, q_{f2}/q_{f1} , for a streamtube that passes through the contracted floodplain. The difficulty comes in estimating the value of q_{f2}/q_{f1} . If it is assumed that there is no interaction between the floodplain and main channel flows, then it follows that all of the approach floodplain flow passes through the contracted floodplain so that $q_{f1} = Q_{f1}/B_{f1}$ and $q_{f2} = Q_{f2}/B_{f2}$. Then with the assumption that $Q_{f1} = Q_{f2}$, the value of q_{f2}/q_{f1} reduces back to B_{f1}/B_{f2} , the geometric floodplain contraction ratio.

Between the two extremes of live-bed scour in the main channel for the contraction caused by a bankline abutment, and floodplain clear-water scour for a very short abutment that terminates on the floodplain at a large setback distance from the main channel, is the case of $Q_{f1} \geq Q_{f2}$. In this instance, the main channel flow entrains a portion of the floodplain flow as it travels from the approach-flow section to the contracted section. For this case, Sturm and Janjua (1994) and Sturm (2006) showed that q_{f2}/q_{f1} can be estimated as $1/M$ where $M = Q_{1unobstructed}/Q_{2total}$. Another alternative is to estimate the values of Q_{f1} and Q_{f2} , and thus q_{f1} and q_{f2} , from the ratio of conveyances as in HEC-RAS, but Sturm and Chrisohoides (1998b) have shown that the latter estimate is not a good one because the flow is not one-dimensional at the contracted section. A better approach is to use a two-dimensional flow model.

6.3 IDEALIZED LONG CONTRACTION SCOUR

Contraction scour has been estimated theoretically by assuming an idealized long contraction with uniform flow occurring in the approach section and in the contracted section. The theoretical development of ideal contraction scour occurred as early as the work of Straub (1934) who established the equilibrium condition for live-bed contraction scour as the scour depth that results in sediment continuity through the contracted flow section as shown in Figure 6-1. He applied the Duboys sediment transport formula (Vanoni 1975), which is generally considered a bed-load transport formula in which bed shear stress is the independent variable, for estimation of the sediment transport rate in the approach-flow and contracted sections.

The work of Straub inspired several subsequent studies of contraction scour based on the idealized long contraction. More recently, additional experimental studies of long contractions have been reported in the literature. Several of the more prominent contraction formulas are given in Appendix B in Table B-1; they are discussed in the same order as given in the table.

Laursen (1960) utilized a similar approach to that of Straub in which he applied his own sediment transport formula to the live-bed case with the result shown in Table B-1 as the Laursen live-bed contraction scour formula. In compound channels he assumed that all of the sediment transport occurs in the main channel. Laursen's sediment transport formula considers both bed-load and suspended-load transport; the coefficient p varies according to the relative contribution of bed load and suspended load to the total sediment transport rate. For an overbank flow

contraction with a bankline abutment, it can be seen that dimensionless scour depth depends only on (Q_t/Q_c) or $(1/M)$ as mentioned earlier, while for main channel flow alone it depends on B_1/B_2 .

Gill (1981) generalized the Straub formula for live-bed scour by assuming that sediment transport rate is proportional to excess shear stress, $(\tau - \tau_c)^\beta$ where β is a numerical exponent equal to 3 for the Einstein-Brown formula and 1.5 for the Meyer-Peter and Mueller formula, for example. The resulting live-bed contraction scour formula is given in Table B-1.

Laursen (1963) also applied the assumption of a long contraction to the case of clear-water scour by assuming that the shear stress in the contracted section has reached its critical value τ_c at the end of the scouring process. Then using Manning's equation for the approach flow and contracted flow, he obtained a ratio of τ_1/τ_c that when combined with the continuity equation yielded the clear-water contraction scour formula given in Table B-1.

6.4 CONTRACTION SCOUR FORMULAS FROM LABORATORY DATA

Komura (1966) emphasized the influence of armoring on live-bed scour depth by arguing that the ratio of the sediment sizes in the approach flow section and contracted section influence the contraction scour depth for large values of B_1/B_2 and σ_{g1} . He applied dimensional analysis to a series of laboratory experiments on live-bed and clear-water contraction scour in a long contraction ($L_c/B_1 \geq 1.0$) and proposed a formula based on his experimental results in which dimensionless scour depth depends on F_1 , B_1/B_2 , and σ_{g1} as shown in Table B-1.

Lim and Cheng (1998a) derived a long contraction scour formula for live-bed scour along the same lines as that of Gill (1981) using a bedload formula in which $\beta=4$, but then showed that the only solution of the equation was one in which the dimensionless live-bed contraction scour depth depends on B_1/B_2 alone as shown in Table B-1. They compared their formula with several sets of laboratory data for long contractions and concluded that it gave reasonable agreement not only with live-bed scour data but also with several sets of clear-water scour laboratory data.

Briaud et al. (2005) conducted flume experiments on clear-water scour of a cohesive sediment (porcelain clay) in a long contraction. From their experimental results, they proposed a formula for maximum dimensionless contraction scour depth (d_{sc}/Y_1) that depends on F_1 , B_1/B_2 , and the critical value of approach flow Froude number, F_{1c} , as shown in Table B-1. They concluded that contraction length has no influence on the scour depth as long as $L_c/B_2 \geq 0.25$. In addition, their results showed no influence of the transition angle on scour depth.

Dey and Raikar (2005) conducted a set of flume experiments on a long contraction using both sand and gravel beds and varied the geometric standard deviation of the sediments. They maintained the flow conditions such that $0.9 < V_1/V_c < 1.0$, i.e. their formula in Table B-1 applies to maximum clear-water contraction scour. Their results showed a significant effect of sediment gradation for $1.4 < \sigma_g < 3$ with a minimum value of scour depth due to armoring given as 25% of the value for uniform sediment. The value of the exponent on (B_1/B_2) in their formula is 1.26 which is somewhat different than the theoretical value and previous experimental values.

6.5 FIELD DATA ON CONTRACTION SCOUR

As with abutment scour, there is a paucity of reliable field data for comparison with the contraction scour formulas in Table B-1. Two major problems with such comparisons is that: (1) the formulas are based on a much simpler set of flow conditions in the laboratory than found in the field; and (2) existing field data are primarily based either on measurements of contraction scour long after the flood event for which the hydraulic parameters may not be known, or on “flood chasing” techniques in which the time of scour measurement may not coincide with the occurrence of maximum temporal scour depth. Furthermore, distinguishing contraction scour from other types of scour is not a straightforward process. Local pier scour is often separated from contraction scour using a concurrent ambient bed surface for the cross section which is essentially a graphical estimate of the cross section that would exist without pier scour at the time of the cross section measurement (Landers and Mueller 1996). After elimination of pier scour, field contraction scour is determined as the difference between the average bed elevation of the contracted bridge section and an assumed average bed elevation that would have existed without the bridge (uncontracted section). The uncontracted bed elevation can only be estimated from plots of the concurrent bed profile both upstream and downstream of the bridge. (Landers and Mueller 1996).

Mueller and Wagner (2005) conducted a comprehensive analysis of the available field data for contraction scour even though it is limited. They compared field data with contraction scour estimates from the formulas of Straub, Laursen, and Komura which were discussed previously. In general, the results were mixed with overprediction in most cases, but instances of underprediction also occurred. More detailed real-time measurements of flow velocities and bed elevations were available for a flood in 1997 on the Pomme de Terre River in Minnesota. The velocity data were not reproduced well by HEC-RAS because the flow through the bridge opening was clearly not one-dimensional. The contraction scour for the bridge was significantly underestimated using the equations recommended in HEC-18; however, this comparison may have been biased by an attempt to separate abutment scour and contraction scour. Mueller and Wagner (2005) concluded that future efforts for computing contraction scour (and abutment scour) require a better balance between the complexity of field conditions and the simplicity of idealized laboratory conditions.

Benedict (2003) measured clear-water contraction scour in the South Carolina Piedmont as the depth of remnant scour holes in the floodplain. Flow data was not available for many of the sites so the 100-year peak discharge was taken as representative for these sites while the historic peak discharge was used where it had been measured or could be estimated from surrounding gauges. The Laursen equation was shown to greatly over-predict the contraction scour under these assumptions. An envelope curve for contraction scour was recommended instead as a function of the geometric contraction ratio defined as $(1 - B_2/B_1)$. The contraction scour depths were shown to vary from nearly zero to the limit of the envelope for all values of the geometric contraction ratio without any apparent trend. Benedict (2003) concludes that “because the envelope was developed from a limited sample of bridges in the (South Carolina) Piedmont, scour depths could exceed the envelope”.

In a follow-up study of live-bed contraction scour in the South Carolina Piedmont and the Coastal Plain, Benedict and Caldwell (2009) estimated the elevation of buried scour surfaces using ground-penetrating radar. They proposed eliminating Q_2/Q_1 from the Laursen live-bed scour equation by assuming that all flow remains in the main channel in order to justify an envelope curve for the contraction scour depth, which depends only on the geometric contraction ratio. By comparing the maximum depth of scour with soil boring data, they concluded that the Piedmont data for scour depth were limited by a scour-resistant subsurface layer that consisted primarily of bedrock, but in a smaller number of cases it was composed of gravel or clay. The Coastal Plain data exhibited a similar scour-resistant layer although some cutting into this layer of no more than 5 ft was evident.

Hong and Sturm (2006) showed that field contraction scour can be modeled in the laboratory using Froude number similarity and equality of V_1/V_c in model and prototype by judicious choice of the model geometric scale and the model sediment size. A 1:45 scale model of a bridge on the Ocmulgee River in Macon, Georgia was constructed in the hydraulics laboratory at Georgia Tech, and bathymetry of a 750 m reach of the river was reproduced. Good agreement was obtained between model and prototype velocity distributions for the 1998 historical flood of 1840 m³/s (50-year flood peak = 2,240 m³/s). The maximum clear-water contraction scour in the laboratory ($V_1/V_c = 1$) agreed with the measured field live-bed contraction scour depth within 5%.

6.6 VERTICAL CONTRACTION SCOUR (PRESSURE SCOUR)

As evidence continues to mount for a higher degree of variability in future climatic conditions, engineers must struggle with more frequent occurrences of submergence, and even overtopping of older bridges, and the need to develop new assessments of design risk for bridges to be built in the future. As a bridge first experiences inlet submergence prior to overtopping, there may be a critical design condition for maximum scour before overtopping relief begins. The work by Arneson and Abt (1998), Umbrell et al. (1998), Lyn (2008), and Guo et al. (2010) has advanced the state of knowledge on vertical contraction scour, but much remains to be done to integrate this information into a comprehensive abutment/contraction scour methodology.

CHAPTER 7.

RECOMMENDATIONS FOR DESIGN ESTIMATION OF ABUTMENT AND CONTRACTION SCOUR DEPTH

From the foregoing discussion, it is apparent that none of the abutment scour or contraction scour formulas listed in Tables A-1 and B-1 satisfy fully the criteria specified in Section 5.4. Furthermore, it is obvious that no simple abutment scour formula can be recommended that will apply to all of the complexities found in the field. Finally, the idealized contraction scour formulas currently in use are problematic because of their basis in assumptions that are not satisfied for bridge contractions which are inherently short contractions, and for which the flow is nonuniform. Given this state of our current understanding of abutment/contraction scour, or lack thereof, it is very difficult to develop design-specific recommendations at this time. Some important strides forward have been made in the past decade, but there much remains to be learned before we have arrived at the more settled and defined state of knowledge that currently exists with respect to pier scour.

In spite of these caveats, some general recommendations can be made and then discussion of a possible path forward to create a unifying model of abutment scour is presented in the following.

7.1 GENERAL RECOMMENDATIONS

- The definition of abutment scour and the formulas by which it is estimated pertain to a combination of local scour due to large-scale turbulence generated by flow separation and constriction scour due to flow acceleration caused by the flow contraction itself. Under these circumstances it would appear that contraction scour should not be computed separately from abutment scour estimates. Therefore, it is recommended that a combined abutment/contraction scour formula be developed.
- Given that many abutment failures due to scour are the result of collapse of an erodible embankment, it is recommended that geotechnical estimates of stability should accompany hydraulic scour estimates as suggested by the NCHRP 24-20 Final Report (Ettema et al. 2010). The precise approach to formulating such estimates requires further work, however.
- It is recommended that abutment toe protection and/or guide banks should be considered for all new installations of abutments. Furthermore, for setback abutments, the setback distance should be large enough to avoid failure of the main channel bank in the event of an embankment failure. This distance depends on the flow distribution in the bridge opening as well as the abutment characteristics.
- A small group of abutment scour formulas using the flow distribution in the bridge section or a similar independent variable are best for estimating abutment scour in compound channels. The idealized long contraction scour depth is a useful reference scour depth for these formulas.
- It is recommended that a clear distinction be made between abutment scour depth estimates by formulas developed for solid abutments and those for erodible embankments and abutments. These formulas should be applied only to the case for which they were developed. The solid abutment scour formulas will predict the maximum potential scour

depth in comparison to erodible abutment/embankment scour formulas that consider the flow relief associated with embankment failure. Unifying these formulas with an adjustment factor for erosion strength of the embankment would be a useful goal.

- It is recommended that a renewed effort be undertaken to educate hydraulic engineers with respect to the complexities of abutment scour and the new numerical and physical modeling tools available to resolve difficult cases.

7.2 SPECIFIC RECOMMENDATIONS

First, it is recommended that contraction scour be viewed as a reference scour depth calculation as suggested in several recent investigations of abutment scour, and that abutment scour be taken as some multiple of contraction scour rather than additive to it. In this context, further refinement of contraction scour equations may not be the most productive approach; rather, the incorporation of contraction scour into abutment scour formulas may be a more realistic and useful goal.

Second, it is recommended that a small subset of abutment scour formulas, each having its desirable attributes, be unified into a single formula in order to develop more realistic and robust procedures for abutment scour prediction. Reducing these formulas to a common form and establishing upper and lower limits of expected abutment scour depending on the limitations of each formula would seem to be a practical path forward. The formulas judged to be most promising in this regard, and with respect to the established criteria, are the following:

1. *Ettema et al.* - It is the only formula that considers an erodible embankment; it has the desirable attributes of reflecting the physics of the abutment scour process both in terms of flow constriction and turbulent structures of the flow separation process albeit in a rudimentary form; and it includes experiments with compound channel geometry although a wider array of experiments is needed. It could in theory be applied to scour Classes I, II, and III channels.
2. *Sturm* - It includes a method of accounting for flow re-distribution due to compound channel geometry with similar independent variables compared to the formula of Ettema et al., and it represents the other extreme of a solid-wall foundation as opposed to an erodible embankment. It is most applicable to Class II channels, Scour Condition B.
3. *Melville* - It is most applicable to short, solid-wall abutments and depends on abutment length rather than the flow distribution in the contracted section, but it can be viewed as comparable to the first two formulas if some width of contracted flow, which is related to the width of the scour hole, is established in the contracted section through which all of the approach floodplain flow passes. It also is at the limit of a solid-wall foundation rather than an erodible one. It is most applicable to Class I and Class III channels.
4. *ABSCOUR* - It contains the desirable attribute of including the direct effect of flow re-distribution on the floodplain through the Laursen contraction scour formula in terms of q_2/V_c , although the adjustment factors for spiral flow and velocity should be re-evaluated in the limit of severe contractions as discussed previously. In addition, the correction

factor related to floodplain width seems to be an ad hoc adjustment for the specialized data of Benedict (2003) that applies only to South Carolina. These adjustment factors should all be re-considered in the process of developing a unified formula that is more generally applicable. ABSCOUR also has the useful feature of a user-friendly computer application that minimizes to some extent the mistakes that can be made by hydraulic engineers without an extensive background in the area of bridge scour.

Although the Briaud (2009) formula does not satisfy the criterion for best parameter framework, it is one of the only databases for cohesive sediments, and the data could be useful in expanding the range of applicability of the final unified formula.

It is suggested that a unifying formula or family of formulas can be formed from the list above with a common set of independent variables, preferably of the form of the Ettema et al. formula. The Ettema et al. and Maryland formulas directly use idealized contraction scour as the reference variable for nondimensionalizing the flow depth after scour at the bridge section while the others use the approach flow depth. Each of these approaches has desirable attributes, and each one should be tested in the effort to develop a unifying formula. Using the contraction scour depth as a reference length scale is very attractive if further work can elucidate the limiting case at the left-hand boundary of Figure 5-8 as discussed previously. It is beyond the scope of the present project to develop a unifying formula, although Figure 5-7 may provide a useful starting point. Such a formula could provide an interim update to the HEC-18 formulas, which currently must be used with informed caution, until the proposed research needs in the next section can be fully satisfied.

Third, it is recommended that a flow chart be developed to be used as a guide to evaluate abutment scour in an informed manner and to assist the judgment of design engineers. Where a unified abutment scour formula predicts very large abutment scour depths or possible embankment failure, appropriate scour countermeasures should be indicated. Geotechnical evaluation of scour could become a routine part of the analysis. For more complex problems, hybrid numerical and laboratory hydraulic models should become a readily accessible option.

Fourth, it is recommended that in the near term, abutments should have a minimum setback distance from the bank of the main channel with riprap protection of the embankment and a riprap apron until better methods are available for estimating the erodibility of the embankment itself. The minimum setback distance would then be that recommended for the width of riprap aprons (see Lagasse et al. 2009: HEC-23). Other scour countermeasures, especially guidebanks, should be seriously considered for protection of the embankment as well.

Fifth, it is recommended that further development of an educational curriculum for hydraulic engineers be undertaken in order to emphasize the proper choice of parameters that go into any scour calculation and in the use of 2D and 3D numerical models to better evaluate the hydraulic parameters. At least in the short term, 2D numerical models should be used on all but the simplest bridge crossings as a matter of course. These issues are discussed further in the next section on research needs. The prediction of critical velocity and the estimates of flow distribution in the contracted section are examples of parameters that are

crucial to the success of any abutment scour formula. Furthermore, implementation of a computerized procedure as in ABSCOUR or HEC-RAS with controls on reasonable values of input parameters would be very helpful.

Finally, it is recommended that a long-term field program of obtaining high-quality, real-time field data be undertaken. Simultaneous measurement of bed elevations and the flow field are possible with in-situ sensing devices that record the data and transmit them for real-time bridge monitoring on the internet. Sites without a large number of complicating factors could be identified, and full reliable data sets of simultaneous hydraulic conditions and bed elevations could be obtained to better understand field scaling issues and the simultaneous interaction of various scour processes driven by the hydrodynamics of the flow. While embarking upon such a program will be expensive and require patience, the results will move the ultimate solution to the abutment scour problem forward more effectively than less-expensive post-flood surveys.

CHAPTER 8.

RESEARCH AND EDUCATION NEEDS

8.1 INTRODUCTION

The preceding chapters show that several groups of factors cause abutment scour to persist as a major cause of bridge waterway failure. One group concerns the need for improved understanding of the processes causing abutment scour and failure. Another group concerns the development of more reliable design methods, including the integration of abutment-scour counter-measures into abutment design. Yet a further group concerns inadequate monitoring and maintenance of bridge waterways so as to avert abutment failure for reasons associated with maintenance of approach-channel conditions. This chapter outlines the primary research and education needs associated with the groups and, thereby, with overall improving the reliability of design estimates of abutment-scour depth. Brief problem statements associated with each research need are given in Appendix C.

Education is included here because some aspects of the substantial advances in abutment-scour knowledge that have occurred since 1990 have yet to be integrated adequately into abutment design and monitoring practice, particularly in regions with limited access to design expertise. Bridge abutments continue to fail for the same reasons they did prior to 1990.

8.2. SCOUR PROCESSES

The primary research needs regarding scour processes concern better definition of abutment scour for the categories of abutment scour outlined in Chapter 6, how scour varies with the parameters determining the potential maximum scour depth, and what considerations limit scour depth at abutments. These needs entail understanding the abutment flow field and its variation with the parameters determining the potential maximum scour depth. They also concern better knowledge about how foundation material erodes. Table 8-1 lists research topics and priorities regarding scour processes. Research needs of highest priority are designated as *Critical*.

The main research needs outlined in Table 8-1 can be summarized as follows:

- i. Laboratory experimental studies aimed at elucidating scour processes (flow field, erosion, geotechnical instability), filling existing data gaps, and for diagnostic comparison with selected field investigations;
- ii. Forensic field investigations of abutment failures during significant flood events at bridges featuring particular abutment types; and,
- iii. The use of numerical models to illuminate flow at abutments, and possibly scour development and embankment failure at abutments.

Table 8-1. Prioritized list of research and education needs addressing improved understanding of abutment-scour processes.

Aspect	Research Need	Priority
Laboratory studies	L1. Additional laboratory hydraulic experiments on realistic abutment foundation structures and abutment shapes with and without countermeasures, methods of modeling embankment material; geotechnical stability aspects; modeling of intermediate length and short erodible embankments and wide abutments	<i>Critical</i>
	L2. Overtopping of erodible embankments and abutment scour under pressure scour conditions	<i>High</i>
Field studies	FS1. Field studies with continuous hydraulic and scour monitoring that assess uncertainties in measurement and that can be compared with laboratory hydraulic models	<i>Critical</i>
	FS2. An overall survey to determine the statistical distribution of embankment failure (including types of failures) relative to other modes of bridge waterway failure.	<i>Critical</i>
Numerical studies	N1. Investigation of sound use of 2D (depth-averaged models) for determining flow distribution through bridge waterways for the short term combined with 3D CFD models and laboratory turbulence measurements to shed further light on hydraulic model scaling issue for the long term	<i>Critical</i>
	N2. Education of engineers concerning limitations of 1D abutment scour prediction formulas and the potential and applicability of 2D and 3D numerical modeling in combination with laboratory hydraulic modeling	<i>High</i>

8.3 DESIGN ESTIMATION OF SCOUR

Before outlining research tasks to improve design methodology as an integral part of the research needs outlined in the previous section, it is useful to refer back to the essential question raised in Section 3.3 – How should abutment design best take abutment scour into account? This basic question leads to a set of specific questions outlined in Section 3.3, and provides important context for research aimed at improved design estimation of scour depth. Most research to date has focused on identifying scour depths at solid-body abutments, without indication of how such scour depths relate to abutment design; though the designer would ensure that the abutment column foundation extends adequately below the scour depth. There is a need to include assessment and improvement of design practice, and to determine guidelines, on how best to address scour at abutments as a part of the research needs in Table 8-1.

The present review (Chapter 3) describes several basic abutment designs (erodible embankment at abutment column, caisson-type (solid wall foundation) abutments). Each basic design likely requires its own tailored relationship for estimating abutment scour depth, but these relationships may possibly be placed in the same form with different values of specific coefficients. Chapter 7 summarizes a set of scour estimation methods for the basic types of abutments, and indeed indicates that currently no single estimation method in its present form suffices for all abutments.

Table 8-2 lists the design-related research tasks needed to improve and validate the design methodologies recommended in Chapter 7. Such improvement and validation should occur concurrently and in concert with satisfaction of the research needs described in Table 8-1. The

listed priorities in Table 8-2 coincide with those of the overall research needs given in Table 8-1. A theme evident in the research needs described here is that of merging existing methods. The leading methods summarized in Chapter 7 contain important insights and reflect the effects of primary parameters, and should be brought into closer relationship with each other and refined. The present evaluation does not advocate the development of yet more methods.

The main design-related tasks that should be coupled to research needs in the previous section are:

- i. For abutments with erodible embankments with abutment columns, merge and validate and/or refine the scour estimations methods proposed by Ettema et al. (2010) and ABSCOUR (MSH 2010) as guided by the scour process research in Table 8-1. These methods both treat abutment scour as an amplification of contraction scour, but the adjustment coefficients reflecting effects of turbulence need to be unified, and less physically based adjustment coefficients that lack specific experimental validation need to be re-evaluated. In addition, geotechnical scaling of laboratory results for erodible embankments to the field require estimation of laboratory embankment strength and erodibility
- ii. For abutments with solid-wall (or caisson-like) foundations, validate and/or refine the scour estimation methods proposed by Sturm (2006) and Melville (1992) using field and laboratory data, and explore unifying these formulas with those of Ettema et al. (2010) to provide a range of scour depth estimates that depend on the strength and type of foundation of the embankment;
- iii. Include scour counter-measures in bridge abutment design. Abutments fitted with an armored apron may be intermediate in form between the abutment types mentioned in items i and ii, above;
- iv. Use two-dimensional flow (depth-averaged) numerical models for estimating flow distribution and scour depth at abutments.

Table 8-2. List of design-related research tasks addressing improved design estimation of abutment scour depth coupled to research needs in Table 8-1.

Aspect	Research Need	Design-related Research Task	Priority
Erodible embankment abutments	L1, FS1	1. Determine if and how the ABSCOUR method (MSHA 2010) and that proposed by Ettema et al. (2010) can be merged and further developed. From diagnostic field studies determine method veracity.	<i>Critical</i>
	L1, FS1	2. Further develop and check the validity of the geotechnical approach to estimating scour depth. From diagnostic field studies determine method veracity.	<i>Critical</i>
	L1, FS1	3. Refine the methods in Task 1 for the limiting case of a short abutment as the channel becomes very wide. From diagnostic field studies determine method veracity.	<i>Critical</i>
	L2, FS1	4. Ascertain how the methods in Task 1 apply, or should be adjusted, for embankments under pressure scour conditions and possibly over-topping. From diagnostic field studies determine method veracity.	<i>High</i>
Solid body abutments	L1, FS1	5. Determine the extent to which the methods proposed by Sturm (2006) and Melville (1992, 1996) can be merged and further developed for solid-wall abutments and then combined with Task 1. in a comprehensive design procedure. From diagnostic field studies determine method veracity.	<i>Critical</i>
	L2, FS1	6. Ascertain how the methods in Task 5 apply, or should be adjusted, for embankments under pressure scour conditions and possibly over-topping. From diagnostic field studies determine method veracity.	<i>High</i>
Abutments fitted with scour counter-measures	L1, FS1	7. Determine how the methods in Tasks 1 and 5 should be adjusted, for embankments fitted with scour counter-measures, notably an armored apron around the abutment toe or sheet-pile skirt. From diagnostic field studies determine method veracity.	<i>Critical</i>
2-D flow numerical methods	N1	8. Utilize a 2-D flow model to determine peak values of flow velocity, unit discharge or shear stress in the vicinity of an abutment, especially if the abutment is located in a channel of irregular geometry, in order to estimate amplification of contraction scour at an abutment.	<i>Critical</i>

8.4 MONITORING AND MAINTENANCE OF BRIDGE ABUTMENTS

Numerous scour-induced failures of bridge abutments often result as a consequence of inadequate monitoring and maintenance of approach channel features (especially the lateral shifting of a channel), and concomitantly at times the deterioration of the abutment embankment (as can be caused by inadequate handling of drains along embankment flanks). Therefore, an important group of research needs relates to improving ways to monitor and maintain bridge waterway conditions in order to avert abutment failure. Developments in monitoring techniques and maintenance methods can help to reduce abutment failure. The ensuing research (and education) needs aim to improve implementation of monitoring and maintenance practice.

- i. Development of instrumentation and techniques to better facilitate routine observation and recording bridge-waterway conditions, and identify waterway and embankment deteriorations that may increase abutment susceptibility to failure scour;
- ii. Development of instrumentation and techniques for determining abutment state during extreme flood-flow events;
- iii. Education of appropriate technical staff about abutment scour processes including those linked to changes in channel alignment and abutment condition (exposure to flow, geotechnical weakening). Also, education regarding monitoring instrumentation and effective options for abutment maintenance; and,
- iv. Determination of additional effective maintenance methods for mitigating abutment failure owing to scour.

Table 8-3. Prioritized list of research and education needs addressing improved methods for monitoring and maintenance (needs I1, I2, and I3 can be combined).

Aspect	Research Need	Priority
Instrumentation for routine monitoring	I1. (a) New instrumentation and techniques for remote-sensing of abutment and bridge waterway state, and for accessible data and image storage; (b) instrumentation for monitoring embankment soil conditions (leverage off COE levee studies) and (c) low-cost instrumentation and techniques for small bridges or bridges in regions with limited resources to monitor bridges.	<i>High</i>
Instrumentation for monitoring during flood flows	I2. (a) Instrumentation for obtaining waterway bathymetry data during flood flows; (b) instrumentation for monitoring embankment soil parameters during flood hydrograph passage.	<i>High</i>
Education	I3. Training of appropriate staff to conduct monitoring activities, and complete effective abutment maintenance.	<i>High</i>
Maintenance	M1. Innovative and efficient methods for repairing, stabilizing, or replacing weakened components of abutments (e.g., strengthening weakened spill-slope soil at abutment column)	<i>Medium</i>

CHAPTER 9.

CONCLUSIONS

9.1 INTRODUCTION

This report comprises an extensive, broad review of scour at bridge abutments, conducted with the intent of providing recommendations for updating AASHTO manuals Policy for Design of Highway Drainage Facilities and Recommended Procedures for Design of Highway Drainage Facilities, so that these manuals present the best available guidelines for abutment scour estimation and countermeasure design, and indicate clear direction as to further research. The present chapter presents the main conclusions of the review.

A key observation providing context for the conclusions is that, though substantial progress has been made in understanding abutment scour, the state of knowledge regarding abutment-scour estimation lags that for pier scour. Indeed, the review cannot arrive at a definite recommendation regarding the adoption of one method for design estimation of depth of abutment scour. For several reasons, as discussed in this report, the existing methods for abutment-scour estimation are inadequately formulated or require further verification:

1. Scour at abutments is strongly influenced by abutment construction. Most abutments consist of an abutment column set amidst an erodible earthfill embankment. However, most abutment formulations are based on laboratory data obtained using abutment models with a solid-wall foundation (similar to half a wide pier);
2. Scant few laboratory studies have replicated abutments with erodible earthfill embankments;
3. Abutment scour at abutments with erodible embankments can result in at least three failure modes, and scour at solid-wall abutments produces yet a different scour form;
4. For abutments with earthfill embankments, which form the majority of abutments in the U.S., two failures may occur (the earthfill embankment and the abutment column); and,
5. Additional processes cause abutments to erode. A particularly common process causing abutment erosion is the lateral migration of the approach channel. The mixing of processes associated with channel migration, the flow field through a bridge waterway, and the flow field at an abutment at times complicates interpretation of field data on abutment scour.

The report's main contribution is its focus on the various scour processes occurring at abutments as actually constructed, and its clear indication as to directions for future research needed to improve the reliability of methods for design estimation of abutment scour.

Additionally, an important observation expressed in the report is the necessity for abutment design practice to address the essential question – How should abutment design account for abutment scour? This essential question quickly leads to a set of specific questions (Section 3.3) concerning the acceptability (or otherwise) of embankment failure. Acceptable reliability of abutment design in relation to scour behooves bridge designers to address this question.

9.2 CONCLUSIONS

The review and evaluation leads to the following main conclusions regarding the six objectives stated in Section 1.3:

1. Abutment-scour literature published since 1990 documents substantial advances in understanding abutment-scour processes. In particular, with regard to Objective 1, knowledge has advanced regarding the following aspects of abutment scour:
 - i. New insights exist regarding scour development at abutments with erodible, compacted earthfill embankments. Differences occur between scour at erodible abutments and scour at solid abutments on solid-wall foundations similar in nature to caisson structures;
 - ii. The flow field around an abutment has essentially the same characteristics as flow fields through short contractions. Notably, flow distribution is not uniform and generates large-scale turbulence. Deepest scour occurs approximately where flow contraction is greatest. As scour develops at abutments with solid-wall foundations, the large-scale turbulence may increase in strength and cause scour to deepen;
 - iii. At least three abutment scour conditions may develop at abutments with erodible embankments, depending on abutment location in a compound channel. Two conditions may result in embankment failure, while the third condition is pier-like scour at an exposed abutment column once an embankment has failed and been breached. These scour-induced failures differ substantially from those in previous studies of abutments modeled as solid bodies with a solid-wall foundation for the case of sheet-piles or other solid, high strength foundations resistant to erosion;
 - iv. The roles of variables (e.g., embankment length) and dimensionless parameters (e.g., embankment length relative to flood-plain width and relative flow distribution in compound channels) defining scour processes have become better understood;
 - v. The leading methods for estimating scour depth better reflect parameter influences;
 - vi. Improved insights exist regarding abutment scour in clay;
 - vii. Insight has been gained regarding the influence of some site complications (e.g., pier proximity); and,
 - viii. Numerical modeling is substantially growing in utility to reveal two- and three-dimensional features of flow distribution of flow at abutments in ways that laboratory work heretofore has been unable to provide.

These advances address a significant portion of the general statement in NCHRP Project 24-8, Scour at Bridge Foundations: Research Needs (Parola et al. 1996) regarding abutment scour research needs. They also address aspects of abutment scour not envisioned for NCHRP 24-8, especially the roles of embankment erosion during abutment scour. However, further significant research has yet to be done in these areas.

2. The following aspects of abutment scour processes remain inadequately understood:
 - i. The role of embankment soil strength, and flood-plain soil strength on scour development and equilibrium scour depth;

- ii. Scour of boundary materials whose erosion characteristics are not adequately understood (some soils, rock). However, existing reliable data indicate that scour depths in cohesive soils and weak rock do not exceed those in cohesionless material;
 - iii. Quantification of factors further complicating the abutment flow field (such as debris or ice accumulation, submergence of bridge superstructure, channel morphology) and erodibility of flood-plain soils; and,
 - iv. Temporal development of abutment-scour depth, especially the relative timings for which scour develops at several locations around an abutment.
3. The evaluation (Chapter 5) outlines the well-understood relationships between scour depth and significant parameters, summarized in Table 5-1. Notable examples of recent information include similitude in hydraulic modeling of flow distribution through a contracted bridge waterway, and the importance of flood-plain and embankment soil strengths.

Groups of primary parameters are identified in Table 5-1. They define the magnitude and approximate distribution of the abutment flow field, and therefore the potential maximum scour depth.

4. An important conclusion drawn from the evaluation (Chapter 6) is the need to define a set of methods for estimating abutment-scour depth associated with different abutment types, notably for abutments with erodible embankments and those with solid-wall foundations:
- i. For abutments with erodible embankments, the estimation methods proposed by Ettema et al. (2010) and ABSCOUR (MSHA 2010) should be further developed with a view to producing a set of methods for scour-depth estimation;
 - ii. For abutments with erodible embankments, further research is needed to develop and verify the geotechnical approach to scour depth estimation; and,
 - iii. For abutments with solid-wall foundations, the estimation methods proposed by Sturm (2006) and Melville (1997, also Melville and Coleman 2000) should be further developed with a view to producing a comprehensive method for scour-depth estimation.
5. The review draws attention to the importance of effective monitoring and maintenance of bridge abutments. Bridge waterway site complexity (flow field, foundation material, embankment material) can introduce significant uncertainty for scour-depth estimation. Moreover, risks attendant to channel changes and possible deterioration of the abutment structure introduce additional uncertainties as to abutment condition. Effective monitoring (inspection schedule and instrumentation) is needed to manage and mitigate the uncertainties.

Finally, it is important that the abutment designer recognize the limits of existing methods for scour-depth estimation and the capabilities of new field and numerical modeling tools through updated continuing education courses.

REFERENCES

- Arneson, L.A. and Abt, S.R., "Vertical Contraction Scour at Bridges With Water Flowing Under Pressure Conditions." *Transportation Research Record* 1647 (1998) pp. 10–17.
- Barkdoll, B., Ettema, R., and Melville, B.W., "Countermeasures to Protect Bridge Abutments from Scour." Report 587, National Cooperative Highway Research Program, Transportation Research Board, Washington, D.C. (2007).
- Benedict, S.T., "Clear-water Abutment and Contraction Scour in the Coastal Plain and Piedmont Provinces of South Carolina, 1996-99." Water Resources Investigation Report 03-4064, U.S. Geological Survey, Reston VA (2003).
- Benedict, S.T., Deshpande, N., Aziz, N.M., and Conrads, P.A., "Trend of Abutment-Scour Prediction Equations Applied to 144 Field Sites in South Carolina." Open-File Report 2003-295, U.S. Geological Survey, Reston VA (2007).
- Benedict, S.T. and Caldwell, A.W., "Development and Evaluation of Live-Bed Pier and Contraction Scour Envelope Curves in the Coastal Plain and Piedmont Provinces of South Carolina." U.S. Geological Survey SIR 2009-5099 (2009).
- Benedict, S.T., "Evaluation of Maryland Abutment Scour Equation through Selected Threshold Velocity Methods." *Transportation Research Record*, No. 2195 (2010) pp. 153-167.
- Briaud, J.-L., Chen, H.-C., Li, Y., Nurtjahyo, P., and Wang, J., "SRICOS-EFA Method for Contraction Scour in Fine-Grained Soils." *Journal of Geotechnical and Geoenvironmental Engineering*, ASCE, Vol. 131, No. 10 (2005) pp. 1283-1294.
- Briaud, J.-L., Chen, H.-C., Chang, K.-A., Oh, S.J., and Chen, X., "Abutment Scour in Cohesive Material." NCHRP Report 24-15(2), Transportation Research Board, National Research Council, Washington, DC (2009).
- Cardoso, A.H., and Bettess, R., "Effects of Time and Channel Geometry on Scour at Bridge Abutments." *Journal of Hydraulic Engineering*, ASCE, Vol. 125, No. 4 (1999) pp. 388-99.
- Chang, F., and Davis, S., "Maryland Procedure for Estimating Scour at Bridge Abutments, Part 2—Clear Water Scour." Proc. of Water Resources Engineering, '98, ASCE, Memphis, TN, (1998) pp. 169-173.
- Chang, F. and Davis, S., "Maryland SHA Procedure for Estimating Scour at Bridge Waterways, Part 1 – Live Bed Scour." In *Stream Stability and Scour at Highway Bridges*, (Eds.) Richardson, E. and Lagasse, P., ASCE, Reston VA, (1999) pp. 401-4011.
- Chrisohoides, A., Sotiropoulos, F. and Sturm, T.W., "Coherent Structures in Flat-Bed Abutment Flow: CFD Simulations and Experiments." *Journal of Hydraulic Engineering*, ASCE, Vol. 129, No. 3 (2003) pp. 177-86.

Coleman, S. Lachlan, C. and Melville, B. “Clearwater Scour Development at Bridge Abutments,” *Journal of Hydraulic Research*, IAHR, Vol. 41, no. 5 (2003) pp. 521-531.

Dey, S. and Raikar, R.V., “Scour in Long Contractions.” *Journal of Hydraulic Engineering*, ASCE, Vol. 131, No. 12 (2005) pp. 1036-49.

Ettema, R., Nakato, T. and Muste, M., “Estimation of Scour Depth at Bridge Abutments.” Final Report, NCHRP 24-20, Transportation Research Board, Washington, DC, (2010).

Fael, C.M.S., Gonzalo, S.-G., Martin-Vide, J.-P., and Cardoso, A.H., “Local Scour at Vertical-Wall Abutments under Clear-Water Flow Conditions.” *Water Resources Research*, Vol. 42, W10408 (2006) 12 pp.

FHWA, “Stream Instability, Bridge Scour and Countermeasures: A Field Guide for Bridge Inspectors.” Federal Highway Administration, National Highway Institute Publication, McLean VA (2009).

Froehlich, D.C., “Local Scour at Bridge Abutments,” Proc. ASCE National Hydraulic Conference, Colorado Springs, Colorado, (1989) pp. 13-18.

Garde, R.J.; Subramanya, K., and Nambudripad, K.D., “Study of Scour Around Spur Dikes.” *Journal of the Hydraulics Division*, ASCE, Vol. 87, No. HY6 (1961) pp. 23-37.

Gill, M.A., “Erosion of Sand Beds Around Spur Dikes.” *Journal of the Hydraulics Division*, ASCE, Vol. 98, No. HY9 (1972) pp. 1587-1602.

Gill, M.A., “Bed Erosion in Rectangular Long Contractions.” *Journal of the Hydraulics Division*, ASCE, Vol. 107, No. 3 (1981) pp. 273-284.

Guo, J., Kerényi, J. K., Shan, H., Xie, Z., Zhai, Y., and Zhao, L., “Time-Dependent Scour Depth under Bridge-Submerged Flow.” Proc. Fifth International Conference on Scour and Erosion, San Francisco, CA (2010).

Hong, S., Gotvald, A., Sturm, T.W., and Landers, M., “Laboratory and Field Measurements of Bridge Contraction Scour.” Proc., 3rd International Conference on Scour and Erosion, CURNET, Gouda, The Netherlands (2006).

Hong, S.H. and Sturm, T.W., “Physical Modeling of Abutment Scour for Overtopping, Submerged Orifice, and Free Surface Flows.” Proc. 5th International Conference on Scour and Erosion, San Francisco (2010).

Kattell, J. and Eriksson, M., “Bridge Scour Evaluation: Screening, Analysis, and Countermeasures.” Gen. Tech. Rep. 9877 1207-SDTDC, U.S. Department of Agriculture, San Dimas, CA (1998).

Kerenyi, K., J. Sterling Jones, and Stein, S., "Bottomless Culvert Scour Study: Phase II Laboratory Report." Report No. FHWA-HRT-07-026, U.S. Dept. Transportation, Federal Highway Administration, McLean, Virginia, (2007) 77pp.

Komura, S., "Equilibrium Depth of Scour in Long Constrictions." *Journal of the Hydraulics Division*, ASCE, Vol. 92, No. 5 (1966) 17-37.

Kothyari, U.C.; Hager, W.H.; and Oliveto, G., "Generalized Approach for Clear-Water Scour at Bridge Foundation Elements." *Journal of Hydraulic Engineering*, ASCE, Vol. 133, No. 11 (2007) pp. 1229-1240.

Lagasse, P.E., and Zevenbergen, L.W., "Evaluation and Update of NCHRP Project 24-08, 'Scour at Bridge Foundation Research Needs.'" NCHRP Project 20-07 Task 178, Transportation Research Board, Washington, DC (2004).

Lagasse, P.E., Clopper, P.E., Pagan-Ortiz, J.E., Zevenbergen, L.W., Arneson, L.A., Schall, L.D., and Girard, L.G., "Bridge Scour and Stream Instability Countermeasures." 3rd Edition, HEC-23, National Highway Institute, Arlington, VA (2009).

Landers, M.N., and Mueller, D.S., "Channel Scour at Bridges in the United States." Federal Highway Administration Report FHWA-RD-95-184, Washington, DC (1996).

Laursen, E.M., "Scour at Bridge Crossings." *Journal of the Hydraulics Division*, ASCE, Vol. 86, No. HY2 (1960) pp. 39-54.

Laursen, E.M., "An Analysis of Relief Bridge Scour." *Journal of the Hydraulics Division*, ASCE, Vol. 92, No. HY3 (1963) pp. 93-118.

Lim, S.Y., "Equilibrium Clear-Water Scour Around an Abutment." *Journal of Hydraulic Engineering*, ASCE, Vol. 123, No. 3 (1997) pp. 237-243.

Lim, S.-Y. and Cheng, N.-S., "Scouring in Long Contractions." *Journal of Irrigation and Drainage Eng.*, ASCE, Vol. 124, No. 5 (1998a) pp. 258-261.

Lim, S.Y., and Cheng, N.-S., "Prediction of Live-Bed Scour at Bridge Abutments." *Journal of Hydraulic Engineering*, ASCE, Vol. 124, No. 6 (1998b), pp. 635-638.

Liu, H.K.; Chang, F.M.; and Skinner, M.M., *Effect of Bridge Construction on Scour and Backwater*, Report CER 60 HKL 22, Department of Civil Engineering, Colorado State University, Fort Collins, CO (1961).

Lombard, P.J. and Hodgkins, G.A., *Comparison of Observed and Predicted Abutment Scour at Selected Bridges in Maine*, Report 08-04, Maine Department of Transportation (2008).

Lyn, D.A., "Pressure-Flow Scour: A Re-examination of the HEC-18 Equation." *Journal of Hydraulic Engineering*, ASCE, Vol. 134, No. 7 (2008) pp. 1015-20.

- Melville, B.W., "Local Scour at Bridge Abutments." *Journal of Hydraulic Engineering*, ASCE, Vol. 118, No. 4 (1992) pp. 615-631.
- Melville, B.W., "Pier and Abutment Scour: Integrated Approach." *Journal of Hydraulic Engineering*, ASCE, Vol. 123, No. 2 (1997) pp. 125-136.
- Melville, B.W., Van Ballegooy, S., Coleman, S.E. and Barkdoll, B., "Countermeasure Toe Protection at Spill-Through Abutments." *Journal of Hydraulic Engineering*, ASCE, Vol.132, No. 3, (2006a), pp. 235-245.
- Melville, B. W., van Ballegooy, S., Coleman, S.E. and Barkdoll, B. "Scour countermeasures for wing-wall abutments," *Journal of Hydraulic Engineering*, ASCE, Vol. 132, No. 6, (2006b) pp. 563-574.
- Melville, B. W., and Coleman, S. E., *Bridge Scour*, Water Resources Publications, Colorado, U.S.A. (2000), 550p.
- MSHA, "Manual for Hydrologic and Hydraulic Design." Maryland State Highway Administration, Baltimore, MD (2010). Report available at www.gishydro.umd.edu.
- Mueller, D.S., and Wagner C.R. "Field Observations and Evaluations of Streambed Scour at Bridges." Report FHWA-RD-03-052, Federal Highway Administration (2005).
- Oliveto, G. and Hager, W.H., "Temporal Evolution of Clear-Water Pier and Abutment Scour." *Journal of Hydraulic Engineering*, ASCE, Vol. 128, No. 9 (2002) pp. 811-20.
- Oliveto, O. and Hager, W.H., "Further Results to Time-Dependent Local Scour at Bridge Elements." *Journal of Hydraulic Engineering*, ASCE, Vol. 131, No. 2 (2005) pp. 97-105.
- Palaviccini, M., Scour Predictor Model at Bridge Abutments, Ph.D. Dissertation, Civil Engineering Department, Catholic University of America, Washington, DC (1993).
- Parola, A.C., Hagerty, D.J., Mueller, D.S., Melville, B.W., Parker, G. and Usher, J. S, "Scour at Bridge Foundations: Research Needs." NCHRP Project 24-8, Preliminary Draft Strategic Plan, Transportation Research Board, Washington, DC (1996).
- Parola, A.C., Hagerty, D.J., Kamojjala, S., "Highway Infrastructure Damage caused by the 1993 Upper Mississippi River Basin Flooding." NCHRP Report 417, Transportation Research Board, Washington, D.C. (1998).
- Richardson, E.V., and Davis, S.R., "Evaluating Scour at Bridges." *Hydraulic Engineering Circular* No. 18, 4th Ed., Federal Highway Administration, Arlington, VA. (2001).
- Straub, L.G., "Effect of Channel Contraction Works upon Regimen of Movable Bed Streams." *Transactions of the American Geophysical Union*, Part 2 (1934) pp. 454-463.

Sturm, T.W., and Janjua, N.S., “Clear-Water Scour around Abutments in Floodplains.” *Journal of Hydraulic Engineering*, ASCE, Vol. 120, No. 8 (1994) pp. 956-972.

Sturm, T.W. and Chrisohoides, A., “Abutment Scour in Compound Channels for Variable Setbacks.” Proc, Water Resources Engineering '98, ASCE, Memphis, Vol. 1 (1998a) pp. 174-179.

Sturm, T.W., and Chrisohoides, A., “One-Dimensional and Two-Dimensional Estimates of Abutment Scour Prediction Variables.” *Transportation Research Record* 1647, Transportation Research Board, National Research Council, Washington, D.C. (1998b) pp. 18-26.

Sturm, T.W., “Enhanced Abutment Scour Studies for Compound Channels.” Publication No. FHWA-RD-99-156, Federal Highway Administration, Turner-Fairbank Highway Research Center, McLean, VA (2004).

Sturm, T.W., “Scour Around Bankline and Setback Abutments in Compound Channels.” *Journal of Hydraulic Engineering*, ASCE, Vol.. 132, No. 1 (2006) pp. 21-32.

Sturm, T.W., *Open Channel Hydraulics*, 2nd Edition, McGraw-Hill, New York (2009).

Umbrell, E.R., Young, G.K., Stein, S.M., and Jones, J.S., "Clear-Water Contraction Scour Under Bridges in Pressure Flow." *Journal of Hydraulic Engineering*, Vol. 124, No. 2 (1998) pp.236–240.

USGS, “Guidance for Bridge Scour Studies.” Office of Surface Water Technical Memorandum No. 2003.06, U.S. Geological Survey, Reston, VA (2003).

Van Ballegooy, S., “Bridge Abutment Scour Countermeasures.” PhD Thesis, The University of Auckland, Auckland, New Zealand (2005).

Vanoni, V., “Sedimentation Engineering.” ASCE Manuals and Reports on Engineering Practice No. 54, ASCE, New York, NY (1975).

Wagner, C.R., Mueller, D.S., Parola, A.C., Hagerty, D.J., and Benedict, S.T., “Scour at Contracted Bridges.” Transportation Research Board, National Cooperative Highway Research Program Document 83, Project 24-14 (2006).

APPENDIX A
Table A-1. A selection of abutment scour formulas (revised and extended from Melville and Coleman 2000).

Reference	Formula	Notes
Garde et al. (1961)	$\frac{d_s}{Y_1} = \Gamma \left(\frac{B}{B-L} \right) F_1^\delta$	Γ and δ are given as functions of the drag coefficient of the sediment
Laursen (1960)	$\frac{L}{Y_1} = 2.75 \frac{d_s}{Y_1} \left[\left(\frac{d_s}{11.5Y_1} + 1 \right)^{1.7} - 1 \right]$	Applies to live-bed scour at an abutment encroaching into the main channel
Laursen* (1963)	$\frac{L}{Y_1} = 2.75 \frac{d_s}{Y_1} \left[\frac{\left(\frac{d_s}{11.5Y_1} + 1 \right)^{7/6}}{\left(\frac{\tau_1}{\tau_c} \right)^{0.5}} - 1 \right]$	Applies to clear-water scour at an abutment encroaching into the main channel τ_1 = grain roughness component of bed shear stress; τ_c = critical shear stress
Liu et al. (1961)	$\frac{d_s}{Y_1} = 1.1 \left(\frac{L}{Y_1} \right)^{0.4} F_1^{0.33}$	Applies to live-bed scour at spill-through abutments; $F_1 = V_1 / (gY_1)^{0.5}$
Liu et al. (1961)	$\frac{d_s}{Y_1} = 2.15 \left(\frac{L}{Y_1} \right)^{0.4} F_1^{0.33}$	Applies to live-bed scour at wing-wall or vertical-wall abutments
Liu et al. (1961)	$\frac{d_s}{Y_1} = 12.5 F_1 \beta$	Applies to clear-water scour at vertical-wall abutments; β = contraction ratio
Gill (1972)	$\frac{Y_2}{Y_1} = 8.375 \left(\frac{d}{Y_1} \right)^{0.25} \beta^{6/7} \left[\beta^{1/m} \left(1 - \frac{\tau_c}{\tau_1} \right) + \frac{\tau_c}{\tau_1} \right]^{-3/7}$	Y_2 = flow depth at bridge $\approx Y_1 + d_s$ Equation given at the threshold condition
Sturm and Janjua (1994)	$\frac{d_s}{Y_f} = 7.7 \left(\frac{F_1}{MF_c} - 0.35 \right)$	F_1 = Froude number of the approach flow upstream of the abutment; F_c = critical Froude number for initiation of motion; $M = Q_o / Q_{tot}$, Q_o = portion of approach flow in bridge opening width, Q_{tot} = total flowrate
Froehlich (1989) (HEC-18)	$\frac{d_s}{Y_f} = 2.27 K_s K_\theta \left(\frac{L}{Y_f} \right)^{0.43} F^{0.61}$	Applies to live-bed scour; Y_f = average depth of flow in the floodplain; $F = V_e / (gY_f)^{0.5}$, $V_e = Q_e / A_e$, Q_e = flow obstructed by the embankment, A_e = flow area corresponding to Q_e
Richardson and Davis (2001) (HIRE)	$\frac{d_s}{Y_1} = 7.27 K_s K_\theta F_1^{0.33}$	Applies when $L/Y_1 > 25$, and for conditions similar to field conditions from which equation was derived
Melville (1992, 1997)	$d_s = K_{yL} K_L K_d K_s K_\theta K_G$	$K_{yL} = 2L$ $L/Y_1 < 1$ $K_{yL} = 2(Y_1 L)^{0.5}$ $1 < L/Y_1 < 25$ $K_{yL} = 10Y_1$ $L/Y_1 > 25$
Lim (1997, 1998b)	$\frac{d_s}{Y_1} = K_s (0.9X - 2)$	Applies to clear-water scour $X = 0.9 \left[\theta_c^{-0.375} F_d^{0.75} \left(\frac{d_{s0}}{Y_1} \right)^{0.25} \left(0.9 \left(\frac{L}{Y_1} \right)^{0.5} + 1 \right) \right]^{-2}$ θ_c = Shields entrainment function F_d = densimetric Froude number

Reference	Formula	Notes
Lim	$\left(1 + \frac{d_s}{2Y_1}\right)^{4/3} = \frac{1 + 1.2\sqrt{L/Y_1}}{\sqrt{(X_L + 1) + \left(\frac{L \tan \phi}{d_s} + 1\right)^{2/3}}} X_L$	Applies to live-bed scour $X_L = \left(1 - \frac{u_{*c}^2}{u_{*1}^2}\right)$ = live-bed parameter
Cardoso and Bettess (1999)	$\frac{d_s}{Y_f} = f\left(\frac{L}{Y_f}\right)$ Melville and Dongol curves form envelope for $3 < L/Y_f < 20$	Clear-water scour; wide main channel relative to floodplain
Sturm (2004, 2006)	$\frac{d_s}{Y_{f0}} = 8.14 \left[\frac{q_{f1}}{MV_{x0c} Y_{f0}} - 0.4 \right]$	Clear-water scour; $q_{f1} = V_{f1} Y_{f1}$; $M = Q_o / Q_{tot}$, Q_o = portion of approach flow in bridge opening width, Q_{tot} = total flowrate; V_{x0c} = critical velocity in floodplain for setback abutment and in main channel for bankline abutment; Y_{f0} = undisturbed floodplain flow depth; Y_{f1} = approach floodplain flow depth
Chang and Davis (1998, 1999), MSHA (2010)	Live-bed $d_s = K_s K_\theta \left[Y_1 K_f K_p \left(K_v \frac{q_2}{q_1} \right)^{K_2} - Y_{0adj} \right] FS$ Clear-water $d_s = K_s K_\theta \left[\left(K_f K_p K_v^{0.857} \frac{q_2}{V_c} \right) - Y_{0adj} \right] FS$	d_s = scour depth; Y_{0adj} = flow depth at bridge before scour; Y_1 = approach flow depth; K_s = shape factor; K_θ = skew factor; K_p = pressure flow factor; K_f = spiral flow adjustment factor; K_v = velocity adjustment factor; K_2 = sediment transport factor (0.637-0.857); q_2 = unit discharge in bridge section; q_1 = unit discharge in flow approach section; FS = calibration/safety factor
Oliveto and Hager (2002, 2005); Kothyari et al. (2007)	$\frac{d_s}{L_R} = 0.068 K_s \sigma_g^{-0.5} F_d^{1.5} \log T$ $\frac{d_s}{L_R} = 0.272 \sigma_g^{-0.5} (F_d - F_{dc})^{2/3} \log T$	Clear-water scour; $L_R = (Y_1 L_a^2)^{1/3}$; $K_s = 1.25$ for rect. abutment; σ_g = geometric st. dev. of sediment; F_d = densimetric grain Froude no. = $V_1 / (g' d_{50})^{0.5}$; $T = t/t_R$; $t_R = L_R / [\sigma_g^{1/3} (g' d_{50})^{0.5}]$; $g' = g(\rho_s - \rho) / \rho$
Fael et al. (2006)	$\frac{d_s}{Y_1} = \sqrt{\frac{\rho_s}{\rho} - 1} \phi \left[\frac{L}{Y_1} \right]$	Function given graphically and combined with Dongol's data to give $\phi = 2-6$ for $1 < L/Y_1 < 100$ and $V/V_c \approx 1$
Ettema et al. (2010)	$\frac{Y_{MAX}}{Y_c} = f\left(\frac{q_2}{q_1}\right)$ (erodible embankment) $\frac{Y_{MAX}}{Y_{fc}} = f\left(\frac{q_{f2}}{q_{f1}}\right)$ (erodible embankment)	Scour condition A in main channel; Y_c = flow depth of live-bed contraction scour in main channel; q_2, q_1 = discharge per unit width in contracted and approach sections of main channel Scour condition B in floodplain; Y_{fc} = flow depth of clear-water contraction scour in floodplain; q_{f2}, q_{f1} = discharge per unit width in contracted and approach sections of floodplain
Briaud et al. (2009)	$\frac{d_s}{Y_1} = 6.5 K_s K_\theta K_l K_p (1.57 F_2 - F_c)^{0.7}$	Y_1 = flow depth upstream from the toe of the abutment; F_2 = Froude no. at the toe of the abutment = $V_2 / (g Y_1)^{0.5}$; F_c = critical Froude number at the toe of the abutment = $V_c / (g Y_1)^{0.5}$ Equations are given for V_2 and V_c

APPENDIX B

Table B-1. A selection of contraction scour formulas (B_1 = approach flow channel width; B_2 = contracted channel width; Y_1 = approach flow channel depth; Y_2 = contracted channel depth after scour)

Reference	Formula	Notes
Straub (1934)	$\frac{Y_2}{Y_1} = \left(\frac{B_1}{B_2} \right)^{6/7} \left[\frac{\tau_c}{2\tau_1} + \sqrt{\left(\frac{\tau_c}{2\tau_1} \right)^2 + \left(1 - \frac{\tau_c}{\tau_1} \right) \frac{B_1}{B_2}} \right]^{-3/7}$	<i>Live-Bed Scour</i> ; τ_c = critical shear stress; τ_1 = approach flow shear stress. Based on DuBoys bedload transport formula
Laursen (1960)	$\frac{Y_2}{Y_1} = \left(\frac{Q_t}{Q_c} \right)^{6/7} \left(\frac{B_1}{B_2} \right)^{p_1} \left(\frac{n_2}{n_1} \right)^{p_2}$	<i>Live-Bed Scour</i> ; Q_c = approach flowrate in main channel ; Q_t = total flowrate through bridge opening main channel; n = Manning's resistance coefficient; p_1, p_2 = exponents from Laursen's total sediment transport formula depending on whether sediment load is mostly bedload, mixed load, or mostly suspended load; B_1 = approach main channel width; B_2 = bridge main channel width.
Laursen (1963)	$\frac{Y_2}{Y_1} = \left(\frac{B_1}{B_2} \right)^{6/7} \left(\frac{\tau_1}{\tau_c} \right)^{3/7}$	<i>Clear-Water Scour</i> . Shear stress in contracted section equal to the critical shear stress τ_c at equilibrium
Komura (1966)	$\frac{Y_2}{Y_1} = 1.45 F_1^{1/5} \left(\frac{B_1}{B_2} \right)^{2/3} \sigma_{g1}^{-1/5} \text{ Live-bed}$ $\frac{Y_2}{Y_1} = 1.60 F_1^{1/5} \left(\frac{B_1}{B_2} \right)^{2/3} \sigma_{g1}^{-1/2} \text{ Clear-water}$	<i>Live-Bed and Clear-Water Scour</i> . F_1 = approach flow Froude number; σ_{g1} = geometric standard deviation of sediment size distribution in approach channel. Includes effect of armoring in contracted section.
Gill (1981)	$\frac{Y_2}{Y_1} = \left(\frac{B_1}{B_2} \right)^{6/7} \left[\frac{\tau_c}{\tau_1} + \left(1 - \frac{\tau_c}{\tau_1} \right) \left(\frac{B_1}{B_2} \right)^{1/\beta} \right]^{-3/7}$	<i>Live-Bed Scour</i> . Sediment transport rate assumed proportional to $(\tau - \tau_c)^\beta$
Lim and Cheng (1998a)	$\frac{Y_2}{Y_1} = \left(\frac{B_1}{B_2} \right)^{0.75}$	<i>Live-Bed Scour</i> . Sediment transport rate assumed proportional to $(V - V_c)^4$ Compared with lab data for both live-bed and clear-water scour.
Briaud et al. (2005)	$\left(\frac{d_s}{Y_1} \right)_{unif} = 1.41 \left(1.31 \frac{B_1}{B_2} F_1 - F_c \right)$ $\left(\frac{d_s}{Y_1} \right)_{max} = 1.90 \left(1.38 \frac{B_1}{B_2} F_1 - F_c \right)$ $L_c / B_1 > 3$	<i>Clear-Water Scour of Porcelain Clay</i> . $unif$ = uniform scour depth; max = maximum scour depth; F_1 = approach flow Froude number; F_c = Froude number with critical velocity

Reference	Formula	Notes
Dey and Raikar (2005)	$\frac{d_s}{Y_1} = 0.368 F_{1e}^{0.55} \left(\frac{d_{50}}{Y_1} \right)^{-0.19} \left(\frac{B_1}{B_2} \right)^{1.26}$	<p><i>Clear-Water Scour</i> ($0.9 < V_1/V_c < 1.0$) $F_{1e} = (V_1 - V_{1c}) / [(SG - 1)gY_1]^{1/2}$; SG = specific gravity; V_{1c} = approach flow velocity when $V_2 = V_c$ at beginning of scour</p>
HEC-18 Richardson and Davis (2001)	$\frac{Y_2}{Y_1} = \left(\frac{Q_2}{Q_1} \right)^{6/7} \left(\frac{B_1}{B_2} \right)^p \quad \text{Live-Bed}$ $Y_2 = \left[\frac{K_u Q_2^2}{d_m^{2/3} B_2^2} \right]^{3/7} \quad \text{Clear-Water}$	<p>Live-Bed formula is the same as Laursen (1960) with the ratio of Manning's n removed; p = sediment transport factor = 0.637-0.857.</p> <p>Clear-Water formula is derived from $Y_2 = q_2/V_c$ and it is different in form, but not in principle, from Laursen (1963) because it does not involve the approach flow section. $K_u = 0.025$ (SI); 0.0077 (EN); $d_m = 1.25 d_{50}$</p>

APPENDIX C

RESEARCH PROBLEM STATEMENTS

C.1 INTRODUCTION

This appendix provides brief problem statements for the research needs and associated design-related research tasks listed in Tables 8-1, 8-2, and 8-3 of Chapter 8. The problem statements comprise short outlines indicating the purpose of the research needed. They can be used to develop project scope and objectives.

C.2 RESEARCH REGARDING ABUTMENT-SCOUR PROCESSES

The ensuing problem statements elaborate the research needs in Table 8-1.

Research Need L1: Laboratory experiments to fill knowledge gaps identified in this report. These are divided into subprojects but could easily be incorporated into a single project.

- a. *Additional experiments on realistic abutment foundation structures with and without countermeasures and on methods of modeling embankment material*

Most investigations of abutment scour have used rigid abutment/embankment models. Ettema et al. (2010) were the first to use erodible embankment models in a comprehensive laboratory study of abutment scour. As shown in Figure 5-8, scour depths at rigid models extending deep into bed material are typically significantly greater than those measured by Ettema et al. (2010) using erodible models. Additional data are needed using an experimental methodology based on that developed by Ettema et al.

The experiments of Ettema et al. (2010) featured a sand bed main channel and both rigid and sand floodplains. Similarly, rigid and erodible (sand) spill-through abutment models were tested; these represented the limiting cases of non-erodible and very erodible materials. Methods are available to develop better ways of modeling the channel bank, floodplain and spill-through slope fill materials, to facilitate more realistic laboratory modeling of the erodibility of such materials and thereby, more realistic simulation of field situations. In particular, the experiments would use a suitable range of shear strength values for the bed and bank materials, with shear strength being appropriately scaled according to the length scales for the models.

The research would include a representative range of realistic abutment models for both wing-wall and spill-through abutments, and abutment/embankment models with and without armor protection, with a specific focus on toe protection of embankment slope armor.

b. Geotechnical stability of embankments exposed to abutment scour

Most cases of abutment failure attributable to scour show a geotechnical failure of the earthfill embankment associated with the abutment. The abutment column typically remains standing. Because spill-slope failure increases the flow area through a bridge waterway, and deposits material in the scour area, the maximum scour depth attainable at an abutment, and damage sustained by an abutment, appears to be limited by the geotechnical stability of an abutment's earthfill embankment. However, the relationship between scour and geotechnical stability of a spill-slope or embankment has never been investigated.

There is a need to address the following aspects:

1. Comprehensively define the essential geotechnical aspects associated with scour of spill-through abutments;
2. Show if and how embankment stability limits scour depth; and,
3. Define the conditions requisite for partial failure as opposed to complete failure

c. Experiments on intermediate length erodible embankments between bankline and short embankments for which compound channel effects are important

Following the successful completion of Research Need L1, or as part thereof, additional data are needed for the case where the abutment is sited on the floodplain with setback distances in the approximate range of $0.4 < L_a/B_f < 1.0$, such that the scour process is influenced by both main channel and floodplain flows. Current ad-hoc methods and even HEC-RAS are insufficient to properly predict the distribution of flow between the floodplain and main channel in the contracted section on which abutment scour, as related to contraction scour, depends. These experiments should include an erodible embankment and should be accompanied by at least 2D numerical methods, or possibly by 3D methods, to develop a relationship for q_2/q_1 in terms of the geometric and flow variables on which it depends. The numerical model should include modeling of the free surface as well as a state-of-the art turbulence sub-model. Once verified by the laboratory experiments, the numerical model can be used to generate a much broader array of results than is possible by experiments alone.

d. Experiments on the limiting case of a short abutment in a wide channel

Following the successful completion of Research Need L1, or as part thereof, additional data are needed for the case where the abutment is sited on the floodplain of a wide channel with relatively large setback distances, such that negligible contraction scour occurs for flow passing through the bridge waterway, and abutment scour is attributable to the flow field generated by the abutment. This abutment situation corresponds to the shaded area in Figure 5.9. For such relatively short abutments scour results from flow contraction locally around the abutment, and turbulence structures generated by flow around the abutment.

Research Need L2: Overtopping of embankments and abutment scour under pressure scour conditions

Within the context of climate change and more commonly occurring pressure scour and overtopping events, experimental research is needed on abutment scour for these flow conditions with realistic compound channel geometry and erodible embankments. Even with riprap protection, the abutment is subject to catastrophic failure under this combination of flow types, especially for moderate to small setback distances from the main channel. The experimental program should include a range of values of relative flow depth on the floodplain with a realistic tailwater curve for the proposed compound channel geometry. Free surface flows that occur prior to submergence of the bridge opening should be included in the experimental program for comparison with the pressure flow and overtopping cases. It is essential to pinpoint the flow conditions for which maximum scour depth occurs in order to develop an assessment of the vulnerability of existing bridges to failure and to devise design criteria for new bridges under climate change scenarios.

Research Need FS1: Field studies with continuous hydraulic and scour monitoring that assess uncertainties in measurement and that can be compared with laboratory physical models

Simultaneous measurement of bed elevations and the flow field are possible with in situ sensing devices that record the data and transmit it for real-time bridge monitoring on the internet. Sites without a large number of complicating factors could be identified, and full reliable data sets of simultaneous hydraulic conditions and bed elevations could be obtained to better understand field scaling issues and the simultaneous interaction of various scour processes driven by the hydrodynamics of the flow. This research would be targeted at specific bridges from which the most useful data sets could be obtained for verification of abutment scour formulas.

Research Need N1: Sound use of 2D (depth-averaged models) for determining flow distribution through bridge waterways for the short term combined with 3D CFD models and laboratory turbulence measurements to shed further light on hydraulic model scaling issues for the long term.

Immediate need exists for informed use of the best possible 2D numerical models, including appropriate turbulence submodels, to develop flow-field parameters needed in the unified scour estimation technique outlined in this report. The most important parameter needed in the short term is the distribution of the discharge per unit width in the bridge contraction section. Extensive opportunities also exist for hybrid modeling (laboratory hydraulic modeling and numerical modeling) to elucidate the flow structure around the various forms of abutment. The brunt of this effort will need to be completed using numerical models because they best reveal the three-dimensional and unsteady features of flow around abutments, particularly those at abutments with solid-wall foundations. Connection of the turbulent structure with appropriate dimensionless variables would allow improved representation of the complex flow fields of the prototype in a physical laboratory model and point the way toward future handling of the more difficult prototype abutment scour problems involving complex flow fields.

Research Need N2: Education of engineers concerning limitations of 1D abutment scour estimation formulas and the potential and applicability of 2D and 3D numerical modeling in combination with physical modeling

Implementation of advanced numerical models requires commensurate education of modelers. Because turbulence is inherently three-dimensional, engineers require basic instruction in the structure of turbulence and how it is modeled in 3D numerical models followed by an introduction to the simplifications concomitant with 2D and 1D numerical models. There is considerable need for engineers to use 2D (depth-averaged flow) numerical models for assessing flow conditions at bridge waterways. The optimal use of such models (their configuration, capabilities, and limitations) has yet to be adequately determined. Various turbulence submodels should be discussed along with issues of grid generation, boundary conditions, discretization techniques, flow resistance, calibration, and verification. In concert with this effort, physical models and their principles should be taught to encourage the hybrid use of physical and numerical models to resolve the most complex bridge abutment scour problems.

Significant potential exists for 3D numerical models to illuminate flow field conditions at abutments. However, further work (and advances in computer technology) is needed to bring such models to a level that they can be used for performing parametric studies on scour processes, and for design purposes.

C.3 RESEARCH TASKS RELATED TO ABUTMENT DESIGN

The ensuing problem statements elaborate the research tasks given in Table 8-2. The task aim at satisfying the research needs listed in Table 8-1.

Task 1. Determine if and how the ABSCOUR method (MSHA 2010) and that proposed by Ettema et al. (2010) can be merged and further developed. From diagnostic field studies determine method veracity.

ABSCOUR (MSHA 2010) and the hydraulic method proposed by Ettema et al. (2010) share the concept that abutment scour is fundamentally an amplification of contraction scour. The two methods have similarities in formulation and prompt the question as to whether they could be developed further as a single method better reflecting improved understanding of scour as amplification of abutment scour. This research effort entails additional critical review of the two methods, and transition to an updated method to be validated using laboratory and field data.

Task 2. Further develop and check the validity of the geotechnical approach to estimating scour depth. From diagnostic field studies determine method veracity.

On the basis of the geotechnical stability of the earthfill embankment at an abutment, Ettema et al. (2010) propose a comparatively simplified formulation for estimating abutment scour depth; if indeed further research shows that a simplified formulation is feasible. Further research is needed to validate or improve upon the formulation, exploring its utility as a practical method relating abutment scour depth to the shear strength of the abutment's earthfill embankment. The

relationship would provide a useful check on scour depth estimated using hydraulics-based methods for scour-depth estimation.

Task 3. Ascertain how the methods in Tasks 1 and 2 apply to, or should be adjusted for, embankments under pressure scour conditions and possibly over-topping. From diagnostic field studies determine method veracity.

The situation termed pressure scour may occur commonly at bridge abutments. Accordingly there is a need to determine how the leading methods for estimating abutment scour depth apply during pressure scour situations. When feasible, conduct diagnostic field studies to determine method veracity.

Task 4. Refine the methods in Tasks 1 and 2 for the limiting case of short abutment as the channel becomes very wide. From diagnostic field studies determine method veracity.

The scour estimation formulations described in problem statements E1 and F1 should be examined for the limiting condition indicated by the shaded area in Figure 5-9. Of interest is whether the formulations can be extended for use for short abutments. The necessary research entails the execution of laboratory flume experiments and verification using field data.

Task 5. Determine the extent to which the methods proposed by Sturm (2006) and Melville (1997) can be merged and further developed for solid-wall abutments. From diagnostic field studies determine method veracity.

The estimation methods proposed by Sturm (2006) and Melville (1997) were developed for estimating scour depth at solid-wall abutments. Both methods contain parameters reflecting scour processes. The question to be investigated is whether they could be developed further as a single method best reflecting improved understanding of scour. This research effort entails additional critical review of the two methods, and transition to an updated method to be validated using laboratory and field data tailored to the types of abutments for which they were developed. This effort could also be unified with the method developed in E1.

Task 6. Ascertain how the methods in Task 5 apply, or should be adjusted, for embankments under pressure scour conditions and possibly over-topping. From diagnostic field studies determine method veracity.

The situation termed pressure scour may occur commonly at bridge abutments. Accordingly there is a need to determine how the leading methods for estimating abutment scour depth apply during pressure scour situations. When feasible, conduct diagnostic field studies to determine method veracity.

Task 7. Determine how the methods in Tasks 1 and 5 should be adjusted, for embankments fitted with scour countermeasures, notably an armored apron around the abutment toe or sheet-pile skirt. From diagnostic field studies determine method veracity.

The inclusion of a countermeasure such as an apron or skirt alters abutment form. As such countermeasures often are recommended for use in abutment design, the scour-estimation methods mentioned for research topics E1 and F1 should be adjusted for abutment forms that include them. The necessary research entails a series of laboratory tests to determine the adjustments.

Task 8. Estimation of contraction scour and its amplification at an abutment will be enhanced when a 2-D flow model is used to determine peak values of flow velocity, unit discharge or shear stress in the vicinity of an abutment, especially if the abutment is located in a channel of irregular geometry.

Two-dimensional, depth-averaged flow models can be used to study the distribution of flow around abutments situated in compound channels and rectangular channels (flow on very wide floodplains may be treated as rectangular channels). Research is needed to acquire useful insights regarding distributions of flow velocity, unit discharge, and boundary shear stress at abutments. Estimation of the peak magnitudes of flow velocity, boundary shear stress, and unit discharge is of substantial importance for design estimation of scour at bridge abutments. Research also is needed to show how abutment flow fields adjust in response to variations of abutment length, floodplain width, and main channel dimensions, and identify trends regarding the magnitude of amplification factors for depth-averaged velocity, unit discharge, bed shear stress, and distance to peak unit discharge.

C.4 RESEARCH NEEDS REGARDING ABUTMENT MONITORING AND MAINTENANCE

The ensuing problem statements elaborate the research needs in Table 8-3.

I1-a. Instrumentation and techniques for remote-sensing of abutment and bridge waterway state, and for accessible data and image storage.

Research is needed on innovative instrumentation and techniques to facilitate image-processing software to readily quantify and document waterway features in the vicinity of bridge abutments, possibly including the free-surface velocity distribution near abutments. The research could use images acquired from close range with conventional photographic techniques. The images can be rectified before mapping the characteristic elements of the banks and floodplain. Methods like Particle Image Velocimetry can be used to estimate the surface velocities in the stream. The instrumentation and software exist today to enable highly versatile techniques for conducting routine bridge inspections, providing quantitative information for a variety of geomorphic and hydraulic waterway parameters. Periodic inspections at bridges followed by processing of the acquired images can provide convenient and accurate means for tracking temporal changes in abutment state and channel conditions at an abutment.

I1-b. Instrumentation for monitoring embankment soil condition.

There is a need to have effective instrumentation for monitoring the strength of embankment soil, especially over time. Instrumentation developed for monitoring slope-stability conditions should be considered for application to bridge abutments whose embankments require monitoring or are of uncertain strength.

I1-c. Low-cost instrumentation and techniques for small bridges or bridges in regions with limited resources to monitor bridges.

The majority of bridges are small bridges, whose number exceeds the capacity of agencies to monitor. Additionally, there are many bridges in regions inadequately resourced to monitor bridge conditions. There is considerable need to develop instrumentation and techniques that facilitate relatively easy and inexpensive monitoring of bridges. Routine monitoring of bridge abutments potentially can avert avoidable failure.

I2-a Instrumentation for obtaining waterway bathymetry data during flood flows.

A major difficulty in developing and verifying methods for design estimation of abutment scour is obtaining bathymetric and flow data during flood-flow conditions. Considerations such as access, safety, and flow-induced loads contribute to the difficulty. Yet, such data and observations are needed to check scour-depth magnitudes and trends obtained from laboratory flume tests and numerical models. In conjunction with IR1 above, good prospects exist for extending various forms of remote-sensing techniques to assist in this regard.

I2-b. Instrumentation for monitoring embankment soil parameters during flood hydrograph passage.

In line with problem statement IF1, there is a similar need for instrumentation for monitoring embankment soil condition during flood hydrograph passage. Information from such instrumentation will assist diagnostic analysis of embankment failure during abutment scour.

I3. Training of appropriate staff to conduct monitoring activities, and complete effective abutment maintenance.

Advanced or new instrumentation and techniques for monitoring require suitably educated staff for successful implantation.

M1. Innovative efficient methods for repairing, stabilizing, or replacing weakened components of abutments (e.g., strengthening weakened spill-slope soil at abutment column)

There is considerable scope for developing various methods for repairing, stabilizing or replacing components of abutments. It is anticipated that effective methods will be developed from technologies used for bank stabilization under diverse circumstances.