

Replacement Processes for Light Emitting Diode (LED) Traffic Signals

DETAILS

0 pages | null | PAPERBACK

ISBN 978-0-309-43567-3 | DOI 10.17226/23006

AUTHORS

BUY THIS BOOK

FIND RELATED TITLES

Visit the National Academies Press at NAP.edu and login or register to get:

- Access to free PDF downloads of thousands of scientific reports
- 10% off the price of print titles
- Email or social media notifications of new titles related to your interests
- Special offers and discounts



Distribution, posting, or copying of this PDF is strictly prohibited without written permission of the National Academies Press. (Request Permission) Unless otherwise indicated, all materials in this PDF are copyrighted by the National Academy of Sciences.

Copyright © National Academy of Sciences. All rights reserved.

ACKNOWLEDGMENT

This work was sponsored by the American Association of State Highway and Transportation Officials (AASHTO), in cooperation with the Federal Highway Administration, and was conducted in the National Cooperative Highway Research Program (NCHRP), which is administered by the Transportation Research Board (TRB) of the National Academies.

COPYRIGHT PERMISSION

Authors herein are responsible for the authenticity of their materials and for obtaining written permissions from publishers or persons who own the copyright to any previously published or copyrighted material used herein.

Cooperative Research Programs (CRP) grants permission to reproduce material in this publication for classroom and not-for-profit purposes. Permission is given with the understanding that none of the material will be used to imply TRB, AASHTO, FAA, FHWA, FMCSA, FTA, Transit Development Corporation, or AOC endorsement of a particular product, method, or practice. It is expected that those reproducing the material in this document for educational and not-for-profit uses will give appropriate acknowledgment of the source of any reprinted or reproduced material. For other uses of the material, request permission from CRP.

DISCLAIMER

The opinion and conclusions expressed or implied in the report are those of the research agency. They are not necessarily those of the TRB, the National Research Council, AASHTO, or the U.S. Government.

This report has not been edited by TRB.

THE NATIONAL ACADEMIES

Advisers to the Nation on Science, Engineering, and Medicine

The **National Academy of Sciences** is a private, nonprofit, self-perpetuating society of distinguished scholars engaged in scientific and engineering research, dedicated to the furtherance of science and technology and to their use for the general welfare. On the authority of the charter granted to it by the Congress in 1863, the Academy has a mandate that requires it to advise the federal government on scientific and technical matters. Dr. Ralph J. Cicerone is president of the National Academy of Sciences.

The **National Academy of Engineering** was established in 1964, under the charter of the National Academy of Sciences, as a parallel organization of outstanding engineers. It is autonomous in its administration and in the selection of its members, sharing with the National Academy of Sciences the responsibility for advising the federal government. The National Academy of Engineering also sponsors engineering programs aimed at meeting national needs, encourages education and research, and recognizes the superior achievements of engineers. Dr. Charles M. Vest is president of the National Academy of Engineering.

The **Institute of Medicine** was established in 1970 by the National Academy of Sciences to secure the services of eminent members of appropriate professions in the examination of policy matters pertaining to the health of the public. The Institute acts under the responsibility given to the National Academy of Sciences by its congressional charter to be an adviser to the federal government and, on its own initiative, to identify issues of medical care, research, and education. Dr. Harvey V. Fineberg is president of the Institute of Medicine.

The **National Research Council** was organized by the National Academy of Sciences in 1916 to associate the broad community of science and technology with the Academy's purposes of furthering knowledge and advising the federal government. Functioning in accordance with general policies determined by the Academy, the Council has become the principal operating agency of both the National Academy of Sciences and the National Academy of Engineering in providing services to the government, the public, and the scientific and engineering communities. The Council is administered jointly by both the Academies and the Institute of Medicine. Dr. Ralph J. Cicerone and Dr. Charles M. Vest are chair and vice chair, respectively, of the National Research Council.

The **Transportation Research Board** is one of six major divisions of the National Research Council. The mission of the Transportation Research Board is to provide leadership in transportation innovation and progress through research and information exchange, conducted within a setting that is objective, interdisciplinary, and multimodal. The Board's varied activities annually engage about 7,000 engineers, scientists, and other transportation researchers and practitioners from the public and private sectors and academia, all of whom contribute their expertise in the public interest. The program is supported by state transportation departments, federal agencies including the component administrations of the U.S. Department of Transportation, and other organizations and individuals interested in the development of transportation. www.TRB.org

www.national-academies.org

CONTENTS

LIST OF FIGURES	iv
LIST OF TABLES	iv
ACKNOWLEDGMENTS	v
ABSTRACT	vi
CHAPTER 1 Background	1
CHAPTER 2 Research Approach	2
CHAPTER 3 Findings and Applications	3
Research Review and Synthesis.....	3
Photometric Measurement Techniques.....	9
LED Traffic Signal Failure Modes	17
CHAPTER 4 Conclusions, Recommendations, and Suggested Research	26
Conclusions.....	26
Recommendations for Replacement Strategies	27
Suggested Research	31
REFERENCES	33

LIST OF FIGURES

Figure 1. Luminous efficiency functions for color-normal and protan observers, and spectral distribution from red incandescent and LED traffic signal modules (Andersen, 2002).

Figure 2. a) Average reaction times and interquartile ranges for color-normal subjects; b) average reaction times and interquartile ranges for protan subjects (Huang et al., 2003).

Figure 3. Block diagram of a typical LED signal module design.

Figure 4. Arrays of 2×20 and 4×20 LEDs in parallel.

Figure 5. Power resistor and smoke residue on nearby LEDs.

Figure 6. Defective Schottky diode.

Figure 7. Locations of failed LEDs.

LIST OF TABLES

Table 1. Measured illuminance and calculated luminous intensity values for different measurement distances (red signal module).

Table 2. Measured illuminance and calculated luminous intensity values for different measurement distances (green signal module).

Table 3. Luminous intensity values estimated from luminance values using luminance test method 1 (red signal module).

Table 4. Luminous intensity values estimated from luminance values using luminance test method 1 (green signal module).

Table 5. Luminous intensity values estimated from luminance values using luminance test method 3 in an exterior, daytime environment (green signal module).

Table 6. Long term annual costs for spot and group replacement strategies for an agency responsible for maintaining 100 signalized intersections, assuming a 7-year expected life. Shaded cells indicate when group replacement is estimated to be more costly than spot replacement.

Table 7. Long term annual costs for spot and group replacement strategies for an agency responsible for maintaining 100 signalized intersections, assuming a 10-year expected life. Shaded cells indicate when group replacement is estimated to be more costly than spot replacement.

ACKNOWLEDGMENTS

The authors acknowledge sponsorship of this research from the National Cooperative Highway Research Program (NCHRP) of the Transportation Research Board. The authors would also like to gratefully acknowledge the City of Los Angeles, the Nebraska Department of Roads, the New Jersey Department of Transportation, the New York State Department of Transportation, and the Wisconsin Department of Transportation for providing traffic signal modules to the project team for evaluation.

ABSTRACT

This report documents and presents the results from a study of the photometric requirements, measurement and maintenance of traffic signal modules using light emitting diodes (LEDs). Differences between LED technology and the incandescent lamps used in previous traffic signal modules in terms of photometric performance, color, and failure modes require new approaches to traffic signal maintenance. Findings from a review of literature on human factors and maintenance practices, from a series of laboratory and field measurements of LED traffic signal modules, and from an analysis of the failure mechanisms of traffic signal modules provided by several different transportation agencies, are provided. Based upon these findings and upon an economic analysis with different assumptions regarding LED traffic signal module failure rates, some preliminary guidance for identifying when group replacement of LED signal modules is feasible is provided, and some possible avenues for future research are recommended.

CHAPTER 1 BACKGROUND

Effective January 2006, the Department of Energy legislated that signal manufacturers may only manufacture traffic signals that meet ENERGY STAR (2003) power requirements, effectively requiring the use of light-emitting diodes (LEDs) in traffic signal heads. In the absence of standards for maintenance of LED traffic signals, transportation agencies face a huge challenge in defining the life expectancy and creating their operational budgets for maintenance of LED traffic signals. As an initial step in developing maintenance guidelines for LED traffic signals, the National Cooperative Highway Research Program (NCHRP) established Project 20-7/246, "Replacement Processes for Light Emitting Diode Traffic Signals," to investigate methods for determining when LED traffic signal heads should be replaced, and to discuss possible specifications for LED traffic signals to maximize reliability and minimize maintenance costs.

A recently-published NCHRP synthesis report, "LED Traffic Signal Monitoring, Maintenance, and Replacement Issues" (Urbanik, 2008), provides very useful background information to the reader. Urbanik (2008) reviewed the results of a survey conducted by the Institute of Transportation Engineers (ITE) in 2006, of transportation agencies regarding their experienced and practices with LED traffic signals. In general it was found that most agencies did not have a systematic replacement program for LED signal modules, nor was funding in place to monitor and (when necessary) replace modules not performing adequately. Some agencies have established replacement programs whereby modules are to be replaced on a group basis after a number of years in service, but the replacement periods can range from five years to longer periods depending upon the assumptions made by each agency. Urbanik (2008) also reported that one state agency (Louisiana Department of Transportation and Development) specified the use of light output monitoring in LED traffic signal modules, but that there were no modules available meeting such specifications.

Because LED traffic signal module failure modes are very different from those of incandescent traffic signal modules, and because the expected operational lifetime of LED modules is so much longer than the operating life of incandescent lamps used in traffic signals, there is a lack of national consensus regarding the best practices for LED traffic signal replacement and for monitoring of signals. The objective of the present project is to identify some of the factors that are related to LED traffic signal module failure, and to discuss some of the steps that might be taken by transportation agencies in the maintenance of LED traffic signal systems.

CHAPTER 2

RESEARCH APPROACH

The project activities, documented in the present report, consisted of the following:

- A review and synthesis of recent human factors research relevant to the visibility and photometric performance of LED traffic signals.
- Evaluation of methods for laboratory and field measurement of LED traffic signal photometric performance.
- Investigation of failure modes of LED traffic signal modules.
- Summary of considerations for departments of transportation (DOTs) in specifying, deploying and maintaining LED traffic signals.

The results of the aforementioned tasks are documented in Chapter 3 of this report, "Findings and Applications." Chapter 4, "Conclusions, Recommendations, and Suggested Research," provides some preliminary guidelines for DOTs regarding practices for maintenance and replacement of LED traffic signal heads.

CHAPTER 3 FINDINGS AND APPLICATIONS

RESEARCH REVIEW AND SYNTHESIS

In the present review and synthesis of human factors research associated with the perception of colored signal lights such as traffic signals, emphasis is placed on recent research on reaction times and missed signals, discomfort glare, and brightness perception. An introduction briefly summarizes current maintenance practices. The present review focuses on research published after 1998, when the first interim specification for LED traffic signals was published by the Institute of Transportation Engineers (ITE, 1998).

LED traffic signal modules have gained popularity in the U.S. primarily because they consume far less energy than incandescent lamps - 85% less, on average (Iwasaki, 2003). Because of these energy savings, the U.S. Environmental Protection Agency (EPA) recognized LED traffic signal modules as an ENERGY STAR product in 2000, and then Congress mandated that as of January 2006, all red and green traffic signal modules must meet the energy consumption specifications stipulated by the ENERGY STAR requirements (ENERGY STAR, 2003).

In addition to energy savings, the use of LED traffic signals has the potential to increase safety at intersections. The reduced power required to operate LED traffic modules has allowed the use of low cost battery backup systems at intersections, increasing safety in the case of blackouts; a \$3,000 backup system can power an intersection for two to four hours (Iwasaki et al., 2003). Also, since the late 1990s, LED modules typically reach end of life by reduced light output, rather than complete failure, so even “failed” modules usually give some signal information to drivers (Behura, 2007).

Maintenance

Behura (2007) reported on a survey of LED traffic signal maintenance practices. He observed that the use of LED traffic signals had been expected to reduce the lifetime cost per module compared with incandescent modules. In addition to reduced energy expenditures, the extended lifetime of the LED modules had been expected to reduce relamping material and labor costs by reducing the frequency these costs will be incurred.

Behura (2007) stated that many agencies had not implemented appropriate maintenance programs for LED signal modules. The survey showed that:

- 35% have no replacement program
- 35% are complaint driven (despite the fact that LED modules typically reach end of life due to dimming rather than complete failure)
- 24% implement routine, scheduled replacement

- 3% replace on vendor product life cycle
- 3% replace based on in-service test results

Rather than relying on a passive maintenance scheme, Behura (2007) suggested several maintenance schemes from most to least precise:

- Remove modules from service and test light output in a laboratory
- Field measurements might provide good results, if they could be done properly
- Statistical analysis based on time since installation
- Replace based on the warranty period

Regardless of the maintenance practice, Behura (2007) recommended keeping a database of modules in the field including location, color, type, manufacturer and model, serial number, date of purchase, date of installation, and warranty end date. Behura also recommended that agencies clean lenses at intervals of one to two years (which would provide an opportunity for field measurements too).

Visibility

Perception and Reaction Time

A study by Bullough et al. (2000) showed that under simulated daylight viewing conditions, LED and incandescent modules of the same nominal color, luminance, and onset time resulted in no statistically significant differences in mean reaction times, percentages of missed signals, color identification accuracy, and subjective brightness ratings. That study (Bullough et al., 2000) did find that reaction times and the percentage of missed signals decreased as luminous intensities (or luminances) increased, and that to obtain the same performance as a red traffic signal meeting then-current photometric requirements for luminous intensity for a 200-mm diameter module, yellow signals had to have a luminous intensity between 1.4 and 2.4 times higher than the red signal, and green signals had to have a luminous intensity between 2.4 and 2.8 times higher than the red signal. Freedman (2001) reported that yellow signals required a luminous intensity for the yellow about twice that of the red to obtain equal visual response, and that green signals required a luminous intensity of 1.3 times higher than red to obtain equal visual response. (Fisher and Cole [1975] recommended a 3:1 luminous intensity ratio for yellow:red and a 1.3:1 ratio for green:red). Taking these studies into account, the ITE recommended a luminous intensity ratio of 2.5:1 for yellow:red and 1.3:1 for green:red in its later specification for LED traffic signal performance (ITE, 2005).

The only discrepancy among these studies is the higher ratio for green signals obtained by Bullough et al. (2000), which might be explained by the background light source used in their study, which had a correlated color temperature of about 3850 K, slightly lower than typical daylight illumination between 5500 and 6500 K (Wyszecki and Stiles, 1982). Regardless, since

the fundamental meaning of the green signal (i.e., "go") is different from that of the red and yellow signals (i.e., "stop"), it could be argued (Bullough, 2002) that equivalent reaction time and brightness for the green signal (relative to red) is not critical for driving safety.

In the study by Bullough et al. (2000) lamp onset time was held constant (by using an electromechanical shutter). However, in the field, the onset time of incandescent traffic control signals is longer than that of LED sources (100 to 200 ms for incandescent, versus 13 to 32 ms for LEDs). Bullough (2005) reported the effect of this variation in onset time, and found that the differences in response time were very short. For example, the difference in response time for red traffic signals meeting the ITE (1998) specifications for luminous intensity, and having rise times of either 17 or 87 ms, was about 30 ms. The same comparison for yellow signals meeting ITE (1998) specifications yielded a response time difference of about 25 ms. Nor did rise time affect the consistency with which a signal was detected, so it was concluded by Bullough (2005) that onset time has little practical consequence for traffic signals.

Cohn et al. (1998) confirmed that the visibility of red LED modules and red incandescent signal modules was about equal under daylight conditions, and concluded that the pixilated appearance of some LED signals might actually provide a visual benefit. This conclusion was confirmed in a subsequent study by Bullough et al. (2002) who found response times to a signal light consisting of an array of point sources, but with equivalent far-field luminous intensity as a diffuse signal light, were shorter than to the diffuse signal light.

While it could be argued that performance metrics such as reaction time and missed signals are most important when considering traffic signals, some studies examined subjective metrics such as brightness and visibility. As described above, Bullough et al. (2000) found no statistically significant difference in perceived brightness between incandescent and LED lamps of the same luminance (for red, yellow, and green) under simulated daylight conditions, although the number of brightness judgments made in that study was relatively small. A study by Bullough et al. (2007) of green LED versus green incandescent signals viewed under nighttime conditions found that the LEDs appeared to be 1.4 to 1.7 times brighter, which is attributed to their saturation.

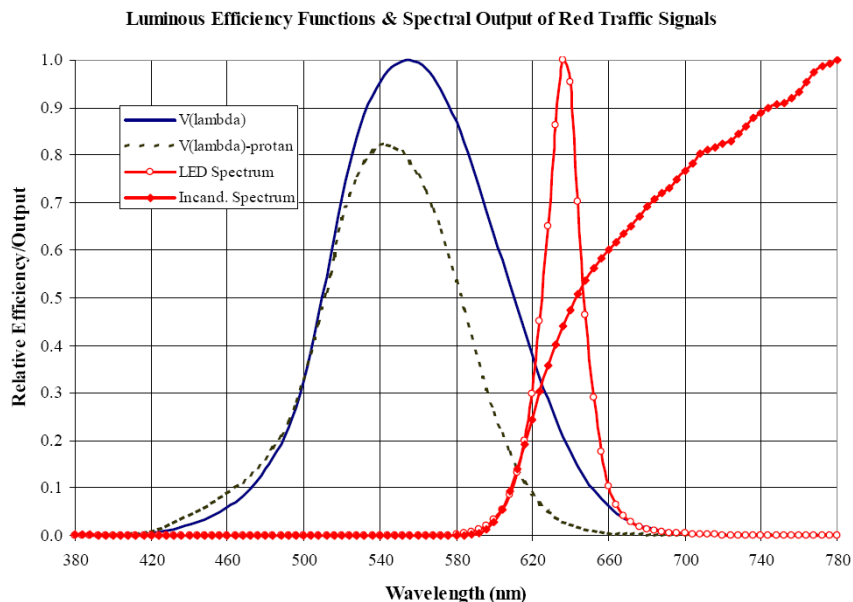

Figure 1. Luminous efficiency functions for color-normal and protan observers, and spectral distribution from red incandescent and LED traffic signal modules (Andersen, 2002).

Color Vision Deficiency

According to a review by Cole (2004) of 124 journal articles, color-deficient drivers:

- Have longer reaction times to signals
- May confuse signal lights with street lights
- Have shorter recognition distances, especially against a bright sky
- Can mistake red lights for yellow (with greater luminance correlated with a greater error rate; this is because color-deficient drivers tend to rely on relative luminance to distinguish between red and yellow signals, so increasing the luminance of a red signal makes it more likely to be interpreted as being yellow)

Because approximately 4% of the population has color deficient vision, significant attention has been paid to this issue when specifying signal properties. Andersen (2002) noted that the specifications were particularly important for the long wavelength cutoff for red signals because the long wavelength end of the luminous efficiency function for protan observers overlaps only with the short wavelength end of the red LED spectrum as shown in Figure 1. He found that shifting the red LED loci by only 8 nm toward the longer wavelengths can result in a 21% difference in the visual signal provided to protan observers.

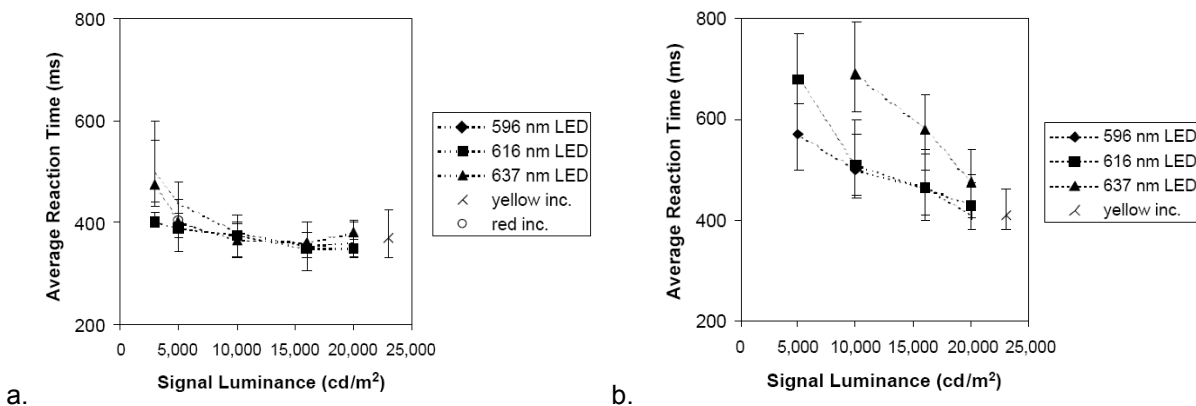

Figure 2. a) Average reaction times and interquartile ranges for color-normal subjects; b) average reaction times and interquartile ranges for protan subjects (Huang et al., 2003).

Huang et al. (2003) found in a series of experiments that for red and yellow traffic signals using LED and incandescent sources, protan observers had longer reaction times (Figure 2), a greater number of missed signals, and a greater number of color misidentifications than color-normal observers. Huang et al. (2003) tested red LED signals with different dominant wavelengths and concluded that the shorter dominant wavelengths improved detection among protan observers, but decreased the rate of correct color identification. The results suggested that the color boundaries specified by the ITE (1998) for each signal color might be improved if boundaries more consistent with recommendations from the Commission Internationale de l'Éclairage (CIE) were used; and this is the case for the current ITE (2005) specification for LED traffic signal colors.

Starr et al. (2004) conducted a field study of green LED traffic signals when viewed under direct sunlight. When traffic signals are viewed under these conditions, they can appear to be lighted even when they are not (the sun phantom effect). Both color-normal and color-deficient observers can misread a signal under these conditions, but it is more common among the color-deficient group. Starr et al. installed fourteen green signals along a route in Minnesota. One of the signals was incandescent, while the rest were LED modules that varied by brand, lens type (tinted or clear), and LED technology (old technology with high LED count versus new technology with lower LED count). Subjects observed the modules while direct sunlight fell on them. The results showed that few (< 4%) color-normal reported that a green signal was on when it was not, but that many more (~25%) of the color-deficient participants falsely reported that a green signal indication was on. While there were variations in results between modules, no clear-cut advantages were identified among the signal modules tested by Starr et al. (2004).

Fog

Kurniawan et al. (2008) conducted a laboratory study of apparent brightness when subjects viewed LED lamps through a fog of water droplets in the laboratory. Subjects viewed LEDs of various colors through fogs of various water droplet sizes and reported the observed brightness level. The authors found that apparent brightness decreased as the fog droplet size increased, and that all colors were affected about equally.

In their study of signal light brightness, Bullough et al. (2007) found that viewing signals through fog reduced the brightness enhancement of LED signals relative to incandescent signals under nighttime viewing conditions, primarily because scattered light from different light sources is superimposed on the signal images, reducing differences among different signal lights.

Discomfort

Bullough et al. (2001) studied the visual discomfort that results from viewing LED traffic modules at night. Based on their results and the 1998 interim LED traffic signal specifications (ITE, 1998), about 40% of the population would be expected to experience discomfort when viewing yellow and green LED signals at night, while red signals would not be expected to produce discomfort. Using the current specifications (ITE, 2005), the percentages for yellow and green would be reduced to about 20%, and for red would remain 0%. Reductions in luminous intensity for yellow and green signals by about 30% at night would be expected to reduce discomfort glare almost completely, while having little impact on the visibility of the signals (Freedman et al., 1985).

Potential Future Research

The research summarized above point to a number of areas where traffic signals could be improved through additional research and development. Several of these concepts have been patented, but are not in widespread practice.

Behura (2007) indicated that LED signal modules should be replaced based on when they become too dim. To streamline the module testing process, a low cost photosensor could be built into each module. A signal indicating the luminous intensity could be transmitted, such as over a dedicated signal line to the control box or using radio frequency transmissions, to the maintaining agency.

Behura (2007) also indicated that the power circuitry is now more likely to fail than the LED light engine itself. This indicates that research on methods to construct low cost, durable power circuitry and devices would be a fruitful way of decreasing the lifetime operating costs of LED modules.

Extensive research has shown that color-deficient drivers have some difficulty detecting and correctly identifying traffic signals under all conditions and that color-normal drivers have difficulty when modules fall under direct sunlight (sun phantom effect). Shape-coding of traffic signal modules has been suggested as a countermeasure for helping overcoming difficulty in viewing by color-deficient observers, and the use of a flashing display is another (Whillans, 1983). Visibility during sun-phantom conditions could be improved by simply increasing (on a temporary basis) the luminous intensity during such conditions and poor ambient weather. Dynamic control of LED intensity results in smaller chromaticity shifts than can be achieved with incandescent lamps, and of course, reductions in intensity can be performed at night to reduce viewer discomfort in accordance with ITE (2005) specifications (provided this does not increase the potential for conflict monitors to have difficulty identifying when the dimmed signals are switched on).

Finally, the research by Starr et al. (2004) shows it would be useful to develop LED modules that do not permit (or at least reduce) the sun phantom effect. In addition to visors, this may be possible through controlling lens properties or the albedo of the back surface of the module.

PHOTOMETRIC MEASUREMENT TECHNIQUES

As described by Behura (2007), luminous intensity of LED traffic signal modules can degrade over time. In accordance with the ITE (2005) specifications for the photometric performance of LED signal modules, the ITE recommends that LED traffic signals be replaced when the intensity of the fixture no longer produces the minimum specified luminous intensity. In order to determine the luminous intensity, the ITE suggests monitoring signals over time using a calibrated light meter. In this manner, light measurements from the same signal could be compared over time to determine a percentage of degradation. The ITE (1998) points out that these relative measurements may not provide an accurate measure of absolute intensity.

It can be difficult for transportation agencies to determine the performance of a traffic signal both in the field and in the shop, because most agencies do not have photometric measurement equipment and sending modules to a laboratory for testing can be expensive and time consuming.

For this reason, the project team investigated several simple methods for measuring LED traffic signal luminous intensity. Two different types of light measuring instruments, an illuminance meter and a luminance meter, were used to estimate the luminous intensity of red and green traffic signal modules under laboratory conditions and under field conditions. Note that the same signals were used throughout the study so that the various methods could be readily compared.

Illuminance Test Method

Illuminance is a measure of the density of light falling on a surface (Rea, 2000). The luminous intensity of a traffic signal module can be determined by measuring the illuminance falling on a light meter (at a sufficient distance from the module) and then applying the inverse square law to determine the luminous intensity needed to produce the measured illuminance. This is the basis for the following test method.

Materials

Red and green 300-mm traffic signal modules, an illuminance meter calibrated to measure narrow-bandwidth spectra, a black-painted room capable of being completely dark, a tape measure, a tripod, and a level were used.

Procedure

The traffic signal module was secured to a table approximately 1.5 m above the floor and leveled such that the face of the signal module was perpendicular to the floor. The signal module was turned on for at least 30 minutes in order for the signal to thermally stabilize to the room temperature environment. The tape measure was extended along the floor from a point directly below the face of the signal to the furthest measuring distance used (approximately 15 m). The illuminance meter was attached to the tripod and the face of the illuminance meter was adjusted so that it was level with the center of the traffic signal. The tripod was then moved to each desired measuring distance. The lights of the room were turned off so that the only light in the room was the light being produced by the signal. A measurement of illuminance was then recorded, and then the lights were turned back on. This process of turning off the lights and recording the illuminance was repeated for every test distance listed in Tables 1 and 2.

Using the measured illuminance from the signal modules at each distance, the luminous intensity of the signal could be determined by applying the inverse square law:

$$\text{Luminous Intensity (cd)} = \text{Illuminance (lx)} \times \text{Distance}^2 \text{ (m)}$$

Results

Tables 1 and 2 summarize the results of the illuminance test method.

Discussion

The luminous intensity of a signal light in a particular direction is invariant as a function of distance from the signal light. Therefore after applying the inverse square law for every illuminance and distance combination in one direction, the luminous intensity value should be the same. The results show that this is the case. The reason this is important is that in order for the inverse square law to be applied correctly the light source must approximate a point source with light diverging from the source. A photometric rule of thumb (Rea, 2000) is that in order for the inverse square law to be applied with low error (<5%), the illuminance measurement distance from the source to the detector should be at least five times the maximum dimension of the source. In the case of a 300-mm traffic signal module this would be 1.5 m; however, a traffic signal module produces partially collimated light that does not necessarily diverge like a point source at 1.5 m. Therefore the measurement distances for this test method were much larger than 1.5 m, and therefore started at more than 6 m from the signal. This starting distance was necessary so that the light would be seen as diverging from the signal like a point source.

Table 1. Measured illuminance and calculated luminous intensity values for different measurement distances (red signal module).

Red Traffic Signal						
Distance (m)		6.10	7.62	9.14	10.67	12.19
Illuminance (lux)	Min	6.48	4.21	2.96	2.11	1.69
Illuminance (lux)	Max	6.55	4.23	3.00	2.16	1.70
Illuminance (lux)	Average	6.52	4.22	2.98	2.14	1.70
Intensity (cd)		242	245	249	243	252

Table 2. Measured illuminance and calculated luminous intensity values for different measurement distances (green signal module).

Green Traffic Signal						
Distance (m)		6.10	7.62	9.14	10.67	12.19
Illuminance (lux)	Min	36.00	22.60	15.50	11.75	9.30
Illuminance (lux)	Max	36.50	22.80	15.80	11.80	9.30
Illuminance (lux)	Average	36.25	22.70	15.65	11.78	9.30
Intensity (cd)		1347	1318	1309	1340	1382

The smaller the test distance needed to provide reasonably accurate results, the easier it will be to find a space to accommodate traffic signal measurements. The differences among the luminous intensity results for the green signal module were less than 6%, and for the red signal module, the differences were less than 4%. This means that the luminous intensity of the signal module could be estimated in a dark room capable of accommodating a 6 m measuring distance with reasonable accuracy. Nonetheless, there can be differences in the optical design of different modules, so distances longer than 6 m should be employed whenever possible.

Luminance Test Methods

Luminance is the measure of light intensity in the direction of an observer per unit projected area of a source (Rea, 2000). It is analogous to the visual response known as brightness. Using a calibrated luminance meter, it is possible to measure the luminance of a traffic signal module directly and then divide the measured luminance by its projected area to determine the luminous intensity.

Several different methods based on measuring the luminance of the traffic signal have been investigated.

Before discussing each test method it is important to describe how a luminance meter is used. Many luminance meters look like a kind of mini-camera with a viewing port, a display, and a measurement trigger. In order to take a luminance measurement, the user should look through the viewing port and aim a marker (usually circular or rectangular) located inside the view port at the object being measured. (The image should also be in proper focus.) A marker inside the viewing port represents a fixed acceptance angle, typically subtending 1 degree in visual angle,

for light to enter the instrument and be measured. After aiming the marker, a trigger is pulled and a luminance measurement is taken, and the value of luminance is displayed.

When a luminance measurement is taken, the light entering the instrument is integrated over the area indicated by the circular or rectangular marker. Because the angle subtended by the marker is fixed, as the distance of the meter from the traffic signal module increases, the marker would cover a larger area of the signal module face. For the present measurements, an instrument with a circular marker nominally subtending 1 degree was used.

Using luminance test method 1, the luminous intensity of the traffic signal module was estimated when the circular marker remained smaller than the angle subtended by the signal module (whereby each measurement represents only a portion of the signal module's face).

Using luminance test method 2, the signal module luminous intensity was estimated by measuring the intensity of the traffic signal module when the circular marker was larger than the traffic signal module, and the surrounding area around the signal was black (i.e., when the measurement was made in a dark environment).

Using luminance test method 3, the luminous intensity was estimated by determining the luminance of the traffic signal module under field test conditions during the day when the circular marker was larger than the angle subtended by the traffic signal.

Color Correction

Luminance meters are calibrated by recording the luminance of a calibration standard having a known luminance value. The calibration standard is typically an incandescent light source producing white light of a known luminance (Rea, 2000). When a luminance meter is used to take measurements of light sources that differ greatly in color from the reference standard, a color correction factor might be necessary to account for deviations in the instrument's sensitivity from the photopic luminous efficiency function at localized wavelength regions, due to limitations of the meter's spectral response system. The color correction factor for a colored light source can be found by measuring a colored light of known luminance and then dividing the measured result by the known value.

For this study the color correction factor for the red and green traffic signals are:

- Red = .882
- Green = .961

These color correction factors were applied to all luminance measurements described below (Tables 3, 4 and 5).

Luminance Test Method 1

The luminance of a traffic signal was measured at increasing distances with the circular marker remaining no larger than size of the signal.

Materials. Red and green 300-mm traffic signal modules, a calibrated luminance meter, a tape measure, a tripod, and a level were used.

Procedure. The traffic signal module was secured to a table approximately 1.5 m above the floor and leveled such that the face of signal was perpendicular to the floor. The signal module was turned on for at least 30 minutes in order for the signal to thermally stabilize. The tape measure was extended along the floor from a point directly below the face of the signal module to the furthest measuring distance (approximately 15 m). The luminance meter was attached to the tripod and the height of the luminance meter was adjusted so that the entrance lens was even with the center of the traffic signal. The tripod was then moved to the desired measuring distance. The lights of the room remained off during this experiment. Luminances were recorded for each distance, and the luminous intensity was calculated as follows:

$$\text{Luminous Intensity (cd)} = \text{Luminance (cd/m}^2\text{)} \times \text{Traffic Signal Area (m}^2\text{)}$$

Table 3. Luminous intensity values estimated from luminance values using luminance test method 1 (red signal module).

Red Traffic Signal									
Distance (m)		3.0	6.1	7.6	9.1	10.7	12.2	13.7	15.2
Luminance (cd/m²)	Min	2434	3743	4533	4660	4265	3793	3332	2914
Luminance (cd/m²)	Max	6139	5202	4551	4690	4439	3811	3430	3050
Luminance (cd/m²)	Average	4190	4549	4545	4680	4322	3804	3373	2965
Signal area (m²)		0.073	0.073	0.073	0.073	0.073	0.073	0.073	0.073
Intensity (cd)		306	332	332	342	316	278	246	216

Table 4. Luminous intensity values estimated from luminance values using luminance test method 1 (green signal module).

Green Traffic Signal									
Distance (m)		3.0	6.1	7.6	9.1	10.7	12.2	13.7	15.2
Luminance (cd/m²)	Min	16299	17903	18922	20191	20931	20969	20911	15847
Luminance (cd/m²)	Max	29608	22929	19643	20537	21219	21882	21478	19585
Luminance (cd/m²)	Average	22533	20783	19303	20392	21075	21212	21248	18301
Signal area (m²)		0.073	0.073	0.073	0.073	0.073	0.073	0.073	0.073
Intensity (cd)		1645	1517	1409	1489	1538	1549	1551	1336

Results. Tables 3 and 4 summarize the results of luminance test method 1.

Discussion. Calculating the luminous intensity using this method requires making an assumption that light emitted from the face of the traffic signal is uniform. This is, however, not the case; rather, the face of the signal module is typically made up of many LEDs, each

producing light and dark patterns over the face of the signal due to their distance from each other and their individual beam patterns.

When the luminance meter was closest to the traffic signal (i.e., at a distance of about 3 m), the circular marker would surround only 4 or 5 individual LEDs. Due to the ratio of the luminance of the LEDs to that of the surrounding background, luminance measurements of different portions of the signal module would be highly variable at such a close distance. As the meter was moved further back, the luminance measurements for different portions of the signal module face were less variable. Moving further back helped to better approximate a uniformly emitting surface. The difference in variability of the measurements with respect to distance can be noted by observing that as distance increased, the minimum and maximum luminance values became closer to each other until about 15 m, when the circular marker started to become larger than the traffic signal module face. For this method, a distance of 9 to 12 m produced the least variable results.

The distance had a large effect on the measurement of luminance. The luminous intensity results were not as consistent for this luminance test method as they were for the illuminance test method.

Luminance Test Method 2

The luminance of traffic signal modules was measured when the circular marker of the luminance meter subtended an angle much larger than the signal module's angular size, with a black surrounding background.

Materials. A green 300-mm traffic signal module, a calibrated luminance meter, a tape measure, a tripod, and a level were used.

Procedure. The traffic signal module was secured to a table approximately 1.5 m above the floor and leveled such that the face of the signal module was perpendicular to the floor. The signal was turned on for at least 30 minutes in order for the module to thermally stabilize. The tape measure was extended along the floor from a point on the floor directly below the face of the signal module to a distance of 28 m. The luminance meter was attached to the tripod and the height of the luminance meter lens was adjusted so that it was even with the center of the traffic signal module. The tripod was then moved to the measuring distance of 28 m. The lights of the room remained off in the room during this experiment. Luminance measurements were recorded.

Calculation and Result. The following interim calculations were used to assess the luminance, and resulting luminous intensity, of the signal module:

Distance = 28 m

Area of traffic signal module = 0.073 m²

Acceptance angle of luminance meter (measured) = 0.93 degrees

Acceptance half angle = 0.465 degrees

Area of circular marker = $\pi \times [\tan(\text{Acceptance half angle}) \times (\text{Distance in m})]^2$

Scale factor = (Area of circular marker in m²)/(Area of traffic signal in m²)

Luminous intensity (cd) = Luminance (cd/m²) × Traffic signal area (m²) × Scale factor

Luminance (measured) = 12000 cd/m²

Resulting luminous intensity = 1954 cd

Discussion. Compared to the illuminance test method (which tended to provide consistent measurement results), luminance test method 2 overestimates the intensity of the traffic signal module's luminous intensity.

Luminance Test Method 3

The luminance of a green traffic signal was measured outside during the daytime in order to simulate a field measurement that might be made by a person from the roadway up at a signal (Condition 1), from the sidewalk up at a signal (Condition 2), and from a bucket truck at a similar height as the signal module (Condition 3).

Materials. A green 300-mm traffic signal module, a calibrated luminance meter, a tape measure, and two tripods were used.

Procedure. There were three measurement location geometries used; one was 5 degrees below the normal from the signal, one was 5 degrees below and 5 degrees to the left of the signal, and one was directly ahead of the signal. Luminance measurements were taken with the signal on and off.

A distance of 23 m was measured and the beginning and end of the distance measurement line were marked with chalk. The traffic signal module was mounted to a large tripod and raised such that the center of the signal was 3 m above the ground. The face of the signal was adjusted to be perpendicular to the ground. The tripod containing the signal was placed at the beginning of the 23 m measurement line. The luminance meter was placed on a tripod and raised so that its lens was 1 m above the ground and then placed at the end of the 23-m distance mark, in line with the center of the traffic signal. Under this condition, the signal was 2 m above the luminance meter lens (corresponding to 5 degrees of angular distance). The luminance meter was aimed toward the signal and measurements were taken from this position. Then, the luminance meter was moved to the left by 2 m, re-aimed toward the signal, and another set of measurements was taken. Finally, the signal was lowered to 1.5 m above the ground, and the luminance meter was raised so that its lens was also 1.5 m above the ground. With this measurement geometry, a final set of luminance measurements was taken.

Calculation. The following interim calculations were used to estimate the luminous intensity of the signal module:

Distance = 23 m

Area of traffic signal module = 0.073 m²

Luminance (cd/m²) = (Luminance On) – (Luminance Off)

Acceptance angle of luminance meter (measured) = 0.93 degrees

Acceptance half angle = 0.465 degrees

Area of circular marker = $\pi \times [\tan(\text{Acceptance half angle}) \times (\text{Distance in m})]^2$

Scale factor = (Area of circular marker in m²)/(Area of traffic signal in m²)

Cosine correction factor = 1/cos(5 degrees) = 1.004

Luminous intensity (cd) = Luminance (cd/m²) × Traffic signal area (m²) × Cosine correction factors × Scale factor

Table 5. Luminous intensity values estimated from luminance values using luminance test method 3 in an exterior, daytime environment (green signal module).

Green Traffic Signal Module						
	Condition 1		Condition 2		Condition 3	
Signal on/off	on	off	On	off	on	off
Distance away (m)	23	23	23	23	23	23
Distance below (m)	2	2	2	2	0	0
Distance to the left (m)	0	0	2	2	0	0
Average luminance (cd/m ²)	13267	6893	13954	5313	9559	540
On-Off luminance (cd/m ²)	6632		8991.5		9384.15	
Cos correction for 5 degrees below	1.003854802		1.003854802		na	
Cos correction for 5 degrees side	na		1.003854802		na	
Area signal (m ²)	0.073		0.073		0.073	
Scale factor	1.482		1.482		1.482	
Luminous intensity	692		942		976	

Results. Table 5 summarizes the results of luminance test method 3.

Discussion. Compared to the illuminance test method, luminance test method 3 underestimates the intensity of the traffic signal's intensity. It is possible that scattered light from the daytime sky contributed to measurements resulting in an underestimation of the true luminance difference between the on- and off-signal module measurements.

Overall Discussion of Traffic Signal Photometric Measurement Methods

The most reliable method for characterizing the luminous intensity of the traffic signal modules used in the preceding series of measurements was the illuminance test method. If a dedicated space for making such measurements and a test jig for mounting the signal module and illuminance meter were able to be set in a fixed location (preferably, with at least 12 m of measurement distance to minimize errors associated with applying the inverse square law [Rea, 2000]). Field measurements of traffic signal intensity based on luminance are prone to variability caused by measurement geometry, non-uniform luminance of module faces, and/or scattered light.

Devices for measuring the luminous flux (or the relative luminous flux) produced by a traffic signal module have been developed whereby a receiver is fitted over the circular module and the luminous flux is gathered into an integrating chamber (Miller and Zaidi, 2002). Such devices can be used for estimating the relative change in luminous intensity for a module that has been previously characterized using far-field photometry. If modules are designed such that individual LED failures might result in an angular-specific degradation of luminous intensity, rather than a uniform reduction of intensity at all angles, then they will not be able to estimate the luminous intensity for a particular direction.

LED TRAFFIC SIGNAL FAILURE MODES

In this study, analyses were conducted on 49 failed LED traffic signal modules representing all three signal colors and three manufacturers. Four modes of failure were commonly found: failure of the startup ("boot strap") circuit in the driver integrated circuit (IC), heat produced by a power resistor degrading adjacent LEDs, failure of a Schottky diode, and general LED failures. Four suggestions are made for designing LED traffic signal modules to lengthen their life: reducing the complexity of the startup circuit, specifying higher-rated or ceramic capacitors, redesigning the array of LEDs, and moving high power components off the main circuit board.

Purpose

The purpose of this study was to identify common causes of failure among LED traffic signal modules.

To accomplish this, the project team solicited failed LED modules from transportation agencies across the country. A total of 61 failed modules were sent to the project team for analysis by the City of Los Angeles, Nebraska, New Jersey, New York State, and Wisconsin DOTs. Of these, 32 were green, 23 were red, and 6 were yellow. Fifty-three were 300-mm modules, 4 were 200-mm modules, and 3 were 125-mm in diameter. (The 125 mm modules were not analyzed as they appear to be used for purposes other than traffic control at signalized roadway intersections.) Three manufacturers were represented among the samples, which are referred to as Brands A, B, and C. Thirty-four were Brand A, 18 were Brand B, and 9 were Brand C. Failure analysis was conducted on 49 of the 61 modules; a preliminary examination led us to believe the remaining modules had similar failure modes.

The following steps were taken to examine the modules:

- The modules were visually inspected for external damage.
- Power was applied via the external wire leads and the module's state of operation (if any) was noted. For example, some modules failed to light at all, while others flickered.

- The modules were opened and the mechanical state of the inside of the module was inspected.
- Attempts were made to get the module to work properly or to identify why it would not, using techniques such as substitution of known good components and application of external power supplies to the LED arrays and/or driver circuits. Based on data sheets for labeled, commercially-available IC chips used in many of the modules, it was possible to predict where supply voltages should be present. This allowed determination of whether the board's power supply was functioning.

In absence of schematics for the proprietary electrical designs of the modules, two resources proved helpful. As mentioned above, when the driver ICs in the units were marked with their part numbers, the manufacturer's (of these components) data sheets provided guidance as to how the circuit worked. These IC data sheets also provided the waveform and voltages that were expected on various pins. Second, we also requested and received a few functioning modules, which provided a standard for comparison.

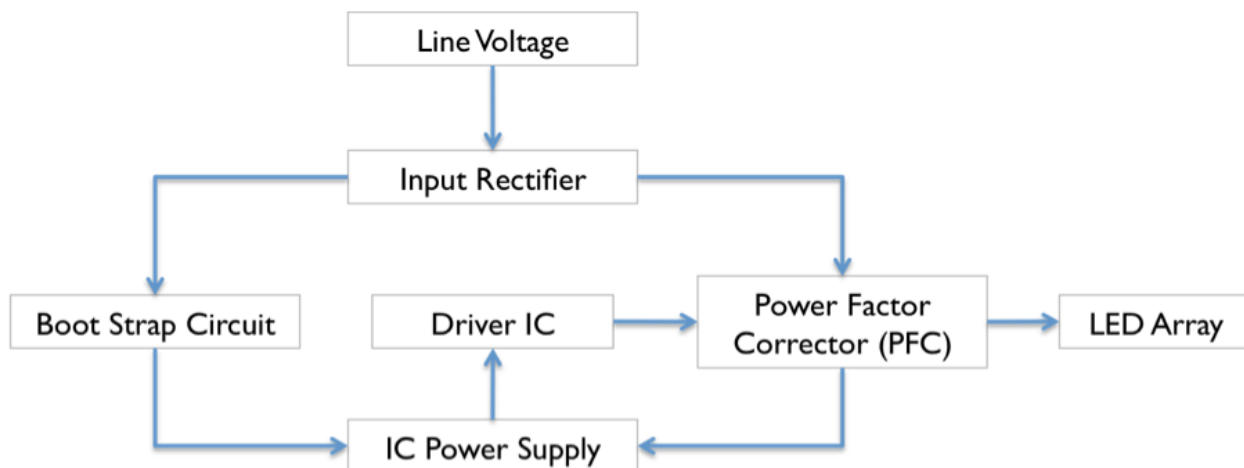

Figure 3. Block diagram of a typical LED signal module design.

The block diagram in Figure 3 shows the operation of a typical functioning traffic signal module. The LED array is driven by a power factor corrector (PFC) which both corrects the power factor and generates the constant current for the LEDs by controlling its output voltage. In steady-state operation, the circuit self-generates the IC supply voltage from the output of the PFC. During startup conditions, there is a boot strap circuit that provides the initial supply voltage until the IC is running, at which point the IC generates its own voltage. The circuit is efficient in providing both power factor correction and constant current without requiring multiple ICs.

Results

Two failure modes were common among the modules from two manufacturers (Brand A and Brand C):

- Fourteen of the 34 Brand A and Brand C modules that were examined (out of the total of 43 Brand A and C modules received) had problems with the boot strap circuit or IC power supply circuit. Typically the failure included one of the resistors overheating and failing, but it is likely that other failures within the power circuitry led to the failure of the resistors. For example, in several units a capacitor failed first, which was the likely cause of the resistor's failure. Many of the modules illuminated if an external power supply was used to power the driver IC.
- Twelve of 34 Brand A and Brand C modules that were examined showed issues caused by a large power resistor physically located within the LED array. The heat given off by this resistor appears to have caused the LEDs located above it to fail, which resulted in a cascade of LED failures. It appears that this issue was recognized by signal module manufacturers, because modules with later date codes had this resistor located on a separate, daughter board.

In addition to these failure modes, it was noticed that the plastic lenses of many modules often had broken screw mounts, indicating that the impact resistance of the plastic might be degraded.

There were two common failure modes of Brand B modules:

- These modules included a Schottky diode in the power circuitry, and eight of the 18 modules examined failed because of a malfunction of this component.
- Five of the 18 modules exhibited general LED failures. In these cases it appeared that the LED lamp itself failed without an (obvious) external cause.

Discussion

While a sufficient number of failed modules were examined to have confidence that common failure modes were identified, the causes of failure of these modules might not be representative of failures among the current installed population of traffic signal modules, for several reasons. First, all of the modules examined were older than five years (they were supplied because their warranty periods had expired). Presumably, manufacturers conducted their own failure analyses on returned modules under warranty and modified their designs subsequently based on the results. As mentioned above, some design modification in response to early failures is evident in the modules examined here. Second, it is to be expected that the rate of module failure would follow the standard "bathtub" curve (Wilkins, 2002): relatively high failure rates initially followed by a period of low failure rate followed by increasing failures due to degradation. Modules that failed soon after installation were sent back to the manufacturer under warranty, so causes of those infant failures, if different than the late-stage degradation failures, would be underrepresented in this study. Third, it is possible that the samples of modules that were received from agencies were not necessarily representative samples of the modules that failed within their territories, even though this is what was requested.

We believe that making several design changes could have prevented many of the failures observed in this study:

First, modules from two manufacturers used a complex boot strap circuit to start up the LED driver IC. The complexity of the design might have been due to an effort to make the module turn on quickly. Reducing the complexity of this circuit would likely increase the reliability of the module by reducing the number of parts that could fail. For example, one could provide the supply voltage to the driver IC by using a conventional power supply with a transformer, diode, and capacitor. Alternatively, all of the drive electronics could be replaced with a rectifier, capacitor, and current limiting resistor. This would result in an increase in reliability but a reduction in efficiency, however.

Second, many modules failed due to the malfunction of electrolytic capacitors used for the power supplies of various ICs in the circuit. Replacing these with capacitors rated to higher temperatures and voltages or switching from electrolytic to ceramic capacitors would eliminate many of these failures.

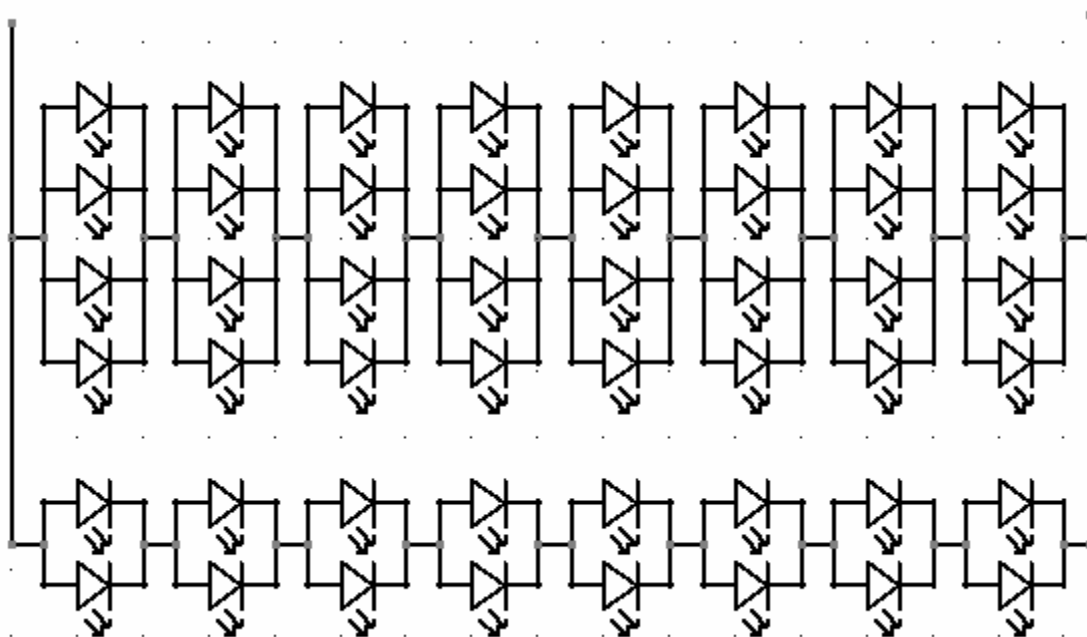

Figure 4. Arrays of 2×20 and 4×20 LEDs in parallel.

Third, the LED arrays could be redesigned to reduce the likelihood of cascading failures. The LEDs in modules from one manufacturer were arranged as 2×20 (sections of 2 LEDs in parallel) and 4×20 arrays (sections of 4 LEDs in parallel) which themselves were in parallel, as shown in Figure 4. If one of the LEDs within a 2-LED-section failed, then the remaining LED in that section would see much higher current, leading to a cascade of failures. If the array were reconfigured as a 6×20 array, then a failure of an LED would be less likely to cause adjacent LEDs to fail.

Fourth, high power components should be removed to the back of the main circuit board or to a daughter board. Higher temperatures lead to shorter life for LEDs (Bullough, 2003), so power components should be kept away from LEDs. In this study, a number of LEDs were

observed that had been discolored due to the heating effects of adjacent power components and smoke traces up the board were observed above power resistors.

Sample Failure Analysis Reports

Following are four failure analysis reports selected from those completed to illustrate the four common failure modes identified in the study.

Failure Analysis #1

Brand: C.

Size: 300-mm.

Color: Red.

Illustrating: Failed resistor in boot strap circuit.

External mechanical inspection: No signs of damage.

Initial application of power: Applied 120 volts alternating current (AC). Unit did nothing. External fuse was intact.

Internal mechanical inspection:

- There were two integrated circuits: a power factor corrector and a divider chain.
- The drive electronics are mounted on a separate printed circuit board.
- Resistor R12 showed signs of excessive heat.

Analysis:

- Resistor R12 measured as open. It was replaced with an array of resistors totaling 520 ohms at 18 watts.
- Replaced electrolytic capacitors on driver board. Unit does not run.
- Applied 12 volts direct current (DC) to the power factor corrector IC to simulate functioning power supply, Unit does not run.
- Drove the LED array from an external source, LED array worked 100%.

Conclusion: The LED drive circuit is not functioning. The failure mode involved overheating resistor R12 (associated with the boot strap circuit). The exact cause could not be determined.

General observations: The drive circuit is quite complex. Without a schematic it is quite difficult to further debug the failure mode.

Failure Analysis #2

Brand: A.

Size: 300-mm.

Color: Green.

Illustrating: Failed LEDs due to proximity to power resistor.

External mechanical inspection: No signs of damage.

Initial application of power: Applied 120 volts AC. Unit did nothing. External fuse was intact.

Internal mechanical inspection:

- There were two integrated circuits: a power factor corrector and a divider chain.
- The drive electronics were mounted on the LED board.
- A power resistor (associated with pulse circuit, R30 in Figure 5) showed signs of excessive heat. There were smoke traces up the board.
- The LEDs above the power resistor were yellowed. There were smoke traces above the resistor.

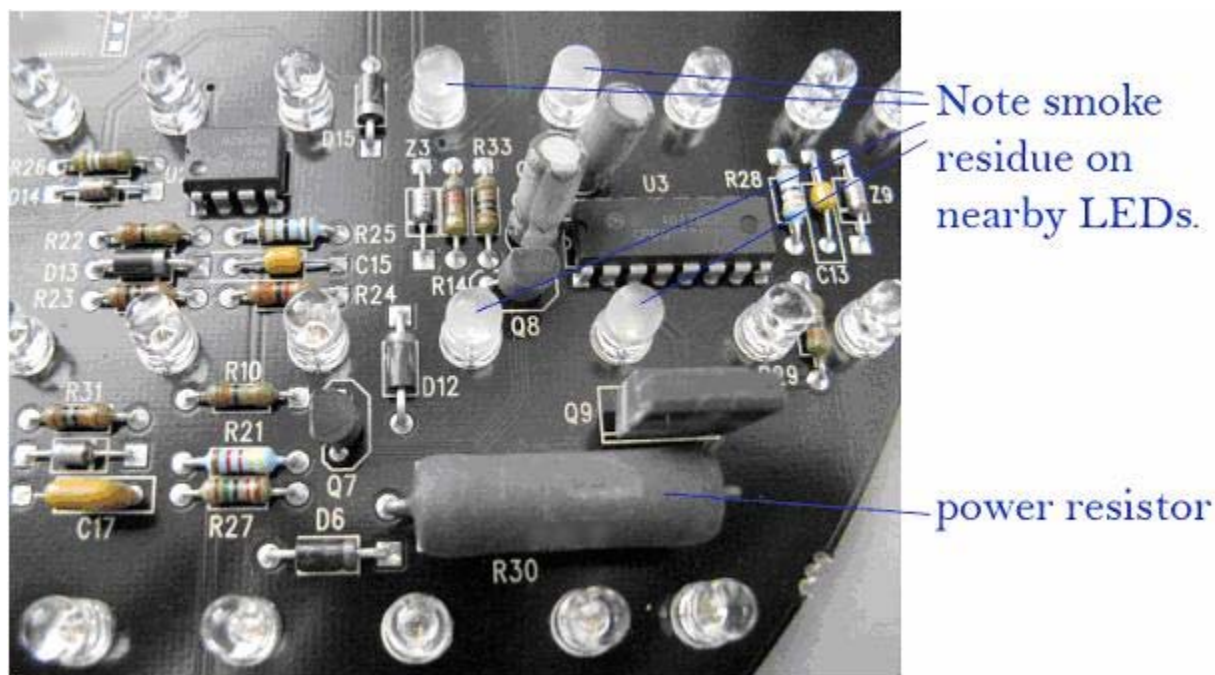

Figure 5. Power resistor and smoke residue on nearby LEDs.

Analysis: It was found that four LEDs on the board were non-functional. When they were shorted to complete the circuit the unit functioned.

Conclusion: The LEDs above the power resistor are four units in parallel. Two of the four had failed so the remaining two were running at twice the expected current. There were two LEDs that failed in the upper portion of the board. The circuit there had two LEDs in parallel. Thus the paired LEDs were also running at twice the expected current. It would be expected that this unit would quickly progress to 100% failure as these overstressed LEDs failed. Two LEDs exhibited significant color changes, perhaps indicating that they had been stressed or were operating at higher temperature. No other reason for the color change could be observed. It could be lot variation of the emitted color.

Failure Analysis #3

Brand: B.

Size: 300-mm.

Color: Green.

Illustrating: Failed Schottky diode.

External mechanical inspection: No signs of damage.

Initial application of power: Applied 120 volts AC. Unit does nothing. Power drain about 2 watts.

Internal mechanical inspection: No apparent damage. Electronics were mounted on secondary card.

Analysis: Replaced several capacitors with no effect. Replaced a Schottky diode and the unit worked. Attached scope to monitor current and voltage to the diode; peak voltage was about 100 volts, peak current about 1 ampere. Diode was rated at 3 amperes, 200 volts. No apparent reason why it failed.

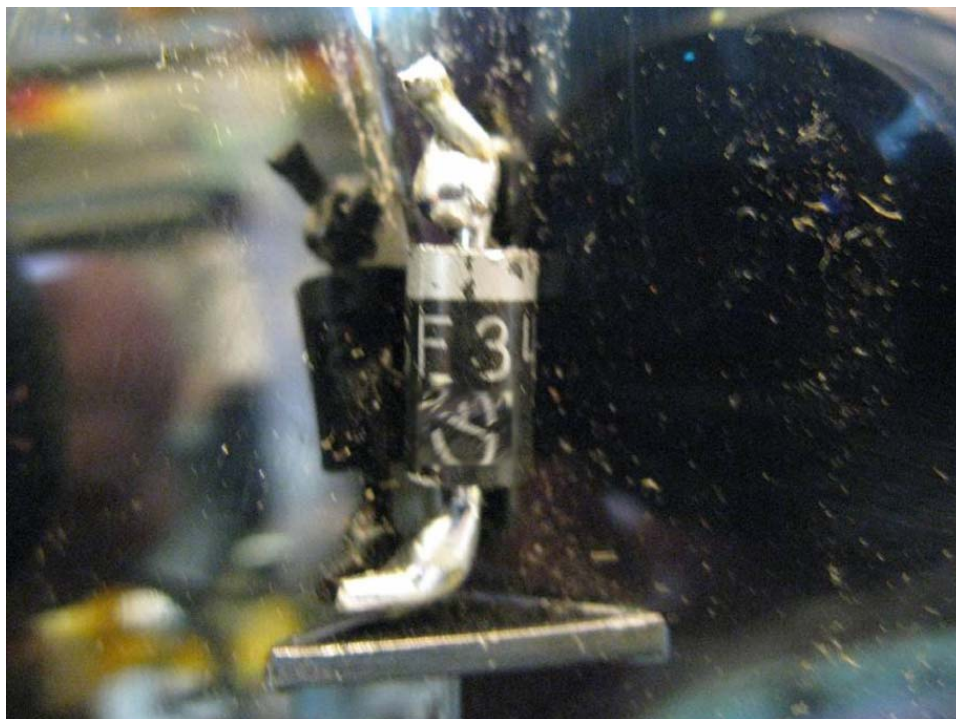

Figure 6. Defective Schottky diode.

Conclusion: The Schottky diode illustrated in Figure 6 failed, causing the drive circuit to malfunction. The reason for its failure was not obvious. The diode appeared to be running well within specs. The replacement diode did not get hot. There were no transient events upon turn-on.

Failure Analysis #4

Brand: B.

Size: 300-mm.

Color: Green.

Illustrating: General LED failures.

External mechanical inspection: Broken plastic near screw, later determined not to be related to the failure.

Initial application of power: Applied 120 volts AC. Unit ran with some LEDs out and some LEDs flickering.

Internal mechanical inspection: No apparent damage. Electronics were mounted on secondary card.

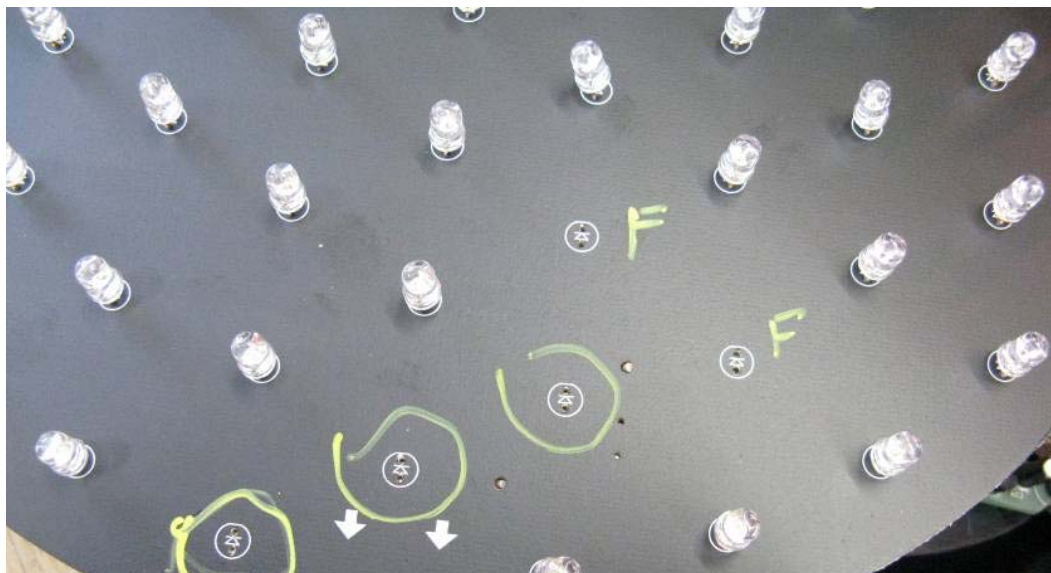

Figure 7. Locations of failed LEDs.

Analysis:

- There was one string of three LEDs out, indicated in Figure 7. The LEDs were pulled. Two were functional, one had failed.
- There was one series string of two LEDs that was flickering, indicated by “F” in Figure 7. The LEDs were pulled. One was functional. The other was thermally intermittent at 25 milliamperes, and flashed.

Conclusion: Two individual LEDs failed or went thermally intermittent (causing the flashing). This caused the associated three LEDs to appear to fail since they were in series strings.

CHAPTER 4 CONCLUSIONS, RECOMMENDATIONS, AND SUGGESTED RESEARCH

CONCLUSIONS

Human Factors Issues

With respect to human factors issues, the change in photometric requirements for red, yellow and green LED signal modules in the current ITE (2005) specifications from the earlier, interim ITE (1998) specifications appear to have been consistent with human visual performance and response to colored signal lights. The use of higher luminous intensity for yellow and green relative to red in the older specification (ITE, 1998) was probably originally based on the higher transmittance of the yellow and green cover lens relative to the red one for incandescent signal modules. Nonetheless, these colors do appear to require higher intensities than red to elicit equivalent reaction times, detection percentages, and perceptions of brightness (Fisher and Cole, 1975; Freedman, 2001; Bullough et al., 2000).

The revision of the signal color boundaries between the previous (ITE, 1998) and current (ITE, 2005) LED specifications also appear to be sensible based on research describing the ability of color-deficient observers (protan and deutan) to detect and properly identify colored light signals (Huang et al., 2003; Cole, 2004).

Evidence exists that LED traffic signals can create measurable discomfort glare when viewed at night (Bullough et al., 2001). Indeed, the current ITE (2005) specification for LED traffic signal modules permits dimming to levels as low as 30% of the daytime luminous intensity. No manufacturers were identified that incorporated this feature, which could also be used during periods of high ambient illumination from the sun to temporarily increase the luminous intensity of a signal module to overcome the sun phantom effect (Starr et al., 2004).

Measurement and Monitoring

Because the current (ITE, 2005) photometric requirements for LED traffic signal modules is a performance specification, improved ease for transportation agencies to monitor and/or measure signal performance would be beneficial to transportation agencies. One manufacturer developed signal modules with an on-board photosensor that could signal when the signal's luminous intensity dropped below minimum performance levels, in response to Louisiana Department of Transportation and Development (DOTD) requirement for such a sensor. However, the module was not compliant with the ENERGY STAR specifications for maximum power (required by the Energy Policy Act of 2005), and Louisiana DOTD no longer uses them (Urbanik, 2008). Hand-held devices that can be placed over a traffic signal module face to gather luminous flux and provide a relative light output measurement in the field are available, but are not widely used because of their cost and because they require a field technician to have access to the signal module face. Field measurement from off-road locations using a luminance meter can be made, but site conditions including the amount of ambient daylight, the specific measurement geometry, angular position and effects of wind or other factors will compromise the accuracy of such measurements.

As summarized in the previous chapter, low-precision measurements can be made using an illuminance meter in a dark room if the geometry between the signal module and the illuminance meter are very carefully controlled so repeatable measurements can be made. Such measurements require a long distance of a minimum of 6 m and preferably at least 12 m to ensure the inverse square law (Rea, 2000) can be applied. Such methods may be useful for tracking the performance of a small sample of working modules, but requires substantial effort to retrieve, measure and record data for each module. Nonetheless, this process may have value for transportation agencies working to estimate practical replacement intervals for LED signal modules.

Until and unless a simple, reliable field measurement method can be developed, and assuming that self-monitoring products meeting ITE (2005) and ENERGY STAR specifications will not be forthcoming in the near future, guidance for transportation agencies regarding strategies for replacement would be useful.

RECOMMENDATIONS FOR REPLACEMENT STRATEGIES

As documented by Behura (2007) and by Urbanik (2008), few transportation agencies have a formal replacement strategy for LED traffic signal maintenance; when signal modules fail or are judged (usually based on visual inspection) to produce insufficient luminous intensity, they are replaced on an emergency or "spot" basis.

For lighting systems with well-documented failure characteristics, such as incandescent and fluorescent lamps, published S-shaped "mortality curves" describing the percentage of lamps likely to fail under normal operating conditions as a function of rated life. Typically for these curves, there are very few lamp failures (<10%) until about 70% of lamp life is reached, after which lamp failures occur at a relatively linear rate until most of the lamps have failed (>90%) by the time 130% of lamp life has been reached (Rea, 2000). As described in the previous chapter, the failure mechanisms for LED traffic signal modules are quite different from those of conventional lighting systems, and often are unrelated to LED technology per se but rather control electronics and other factors. Failure can be caused by burned-out indications, or by luminous intensity reductions below the ITE (2005) specified minimum values.

Documentation of the failure properties of LED traffic signal modules in the field is scarce. Bronson (2005) surveyed transportation agencies in California and respondents reported on average, that about 12% of signal modules failed over a five-year period. In the survey reported by Urbanik (2008), the median value for burned-out signal modules within a period of five years was close to 5%, and the median value for the acceptable percentage of modules that might produce luminous intensities below the ITE (2005) specification within this time frame was also close to 5%. Assuming that such failures would be distributed equally throughout the five-year warranty period, these results suggest that an annual failure rate of around 2% might be a reasonable value to expect in the field, at least as a preliminary estimate.

Group Replacement Cost Sensitivity Analysis

The primary value of group replacement strategies in comparison with spot replacement strategies is the potential for reduced cost of labor for the replacement process. This is because time to travel to and from an intersection, to set up temporary traffic control, can be needed only once if all of the signal modules at that intersection will be replaced. This can also be performed during regular work hours when field technicians have access to vehicles and equipment for replacement. Spot replacement can require greater costs because many replacements are needed outside of regular work hours, and workers may have to travel to a maintenance facility to get needed equipment and vehicles.

In the present series of analyses, the effect of group replacement is considered using different assumptions about failure rates, in comparison to a spot replacement strategy. The following assumptions are made:

- A transportation agency is responsible for 100 signalized intersections, each with an average of 10 LED signal modules (for a total of 1000 LED signal modules).
- The material cost of an LED signal module is assumed to be \$75.
- During work hours, it is assumed that 15 minutes of travel to and from the intersection and 5 minutes to set up traffic control is required, per trip to an intersection.
- Outside work hours, it is assumed that 30 minutes of travel to and from the intersection and 5 minutes to set up traffic control is required, per trip to an intersection.
- Removal and replacement of a single LED signal module is assumed to require 9 minutes.
- Labor costs for a two-person crew during work hours are \$100/hour and outside work hours are \$150/hour.

Using the assumptions listed above, the cost to replace all 1000 of the LED signal modules on a spot basis, where workers would need to travel and set up traffic control for each signal module, would be \$110,500 for labor and \$75,000 for materials, or \$185.50 per module replaced. In comparison, the cost to replace all 1000 LED modules on a group replacement basis (where 10 modules could be replaced during a single trip to an intersection) would be \$18,700 for labor and \$75,000 for materials, or \$93.70 per module replaced.

Of course, even with a group replacement strategy, some LED signal modules will fail before they would otherwise be replaced and therefore, spot replacement of some modules will always be necessary even with a group replacement strategy. If the planned replacement period is too long, the bulk of replacement costs may be spot replacements with little savings associated with group replacement. If the planned replacement period is too short, costs will increase

because of the lost opportunity created by disposing of many otherwise functional modules that could have operated for longer periods.

To assess appropriate periods for group replacement, the total long-term cost of replacing LED signal modules was assessed using two different assumptions for the expected life of LED signal modules: 7 years (City of Little Rock, 2003; SEDA-COG, 2008) and 10 years (Urbanik, 2008); and for several different failure rates: an S-shaped curve matching the failure profile for both incandescent and fluorescent lamps (Rea, 2000), and constant failure rates corresponding to 1%, 3% and 5% failures per year (some higher and lower than the 2% per year figure described above). Spot and group replacement costs were assessed, using replacement periods of 4, 5 and 6 years when a 7-year expected life is assumed, and replacement periods of 6, 7, 8 and 9 years when a 10-year expected life is assumed. Tables 6 and 7 show the long-term annual replacement costs under each scenario. Only labor and material costs for LED signal module replacement are included; it is assumed that the energy costs would be the same for spot and group replacement since all assume LED signal modules.

Table 6. Long term annual costs for spot and group replacement strategies for an agency responsible for maintaining 100 signalized intersections, assuming a 7-year expected life. Shaded cells indicate when group replacement is estimated to be more costly than spot replacement.

Expected Life (years)	Long-Term Annual Spot Replacement Cost	Planned Replacement Period (years)	Expected Failure Rate	Long-Term Group Replacement Cost
7 years	\$26,500	4 years	S-shaped	\$25,400
			1%/year	\$25,200
			3%/year	\$28,900
			5%/year	\$32,500
		5 years	S-shaped	\$23,400
			1%/year	\$20,700
			3%/year	\$24,400
			5%/year	\$28,100
		6 years	S-shaped	\$24,300
			1%/year	\$17,400
			3%/year	\$21,100
			5%/year	\$24,785

Table 7. Long term annual costs for spot and group replacement strategies for an agency responsible for maintaining 100 signalized intersections, assuming a 10-year expected life.

Shaded cells indicate when group replacement is estimated to be more costly than spot replacement.

Expected Life (years)	Long-Term Annual Spot Replacement Cost	Planned Replacement Period (years)	Expected Failure Rate	Long-Term Group Replacement Cost
10 years	\$18,600	6 years	S-shaped	\$17,300
			1%/year	\$17,500
			3%/year	\$21,200
			5%/year	\$24,900
		7 years	S-shaped	\$16,300
			1%/year	\$15,200
			3%/year	\$18,900
			5%/year	\$22,700
		8 years	S-shaped	\$16,500
			1%/year	\$13,600
			3%/year	\$17,300
			5%/year	\$21,000
		9 years	S-shaped	\$17,600
			1%/year	\$12,300
			3%/year	\$16,000
			5%/year	\$19,700

In general, as expected, the estimated costs are lower for signal modules with a longer expected life. For spot replacement strategies, the cost of replacement is inversely related to the expected life. And for both expected lifetimes, if the expected number of failures per year is less than 3%, a planned replacement period of about 80% of expected life will reduce replacement costs relative to spot replacement. If the observed failure rate exceeds 3%, an agency should consider group replacement only very cautiously, as costs might exceed those from a simple spot replacement strategy.

Further cost savings might be achieved in a group replacement program if a photometric or visual assessment of modules removed from service could be performed. Under such a program, modules could be measured using a technique such as the illuminance test method summarized in the previous chapter, or simply assessed visually in comparison to a new module of the same color and type. Modules still exceeding the ITE (2005) recommendations, or those appearing similar in brightness appearance to a new signal module, could be set aside and used for spot replacement for signal modules, especially those that would undergo group replacement within two or three years. An agency might set aside the top 10% of measured or visually assessed modules for this purpose.

SUGGESTED RESEARCH

The review of research and the results of the activities conducted for the present project lead to several suggestions for research activities that could be undertaken to help transportation agencies develop maintenance programs:

- Refinement of sensor systems for reliably detecting when a traffic signal module does not produce the luminous intensity recommended by the ITE (2005) performance specifications. The field and laboratory measurement procedures described in the previous chapter of this report have focused mainly on the light output near the direction of maximum luminous intensity. Of course, the ITE (2005) recommendations require a luminous intensity distribution at wider angles in order to ensure its visibility at more oblique angles of view. Some LED signal modules with visible LED arrays can display a partial indication if some of the LEDs fail, and this could affect luminous intensity in one direction while having little influence in another direction. Thus, multiple sensors, each able to characterize light output in a different directional region, might be appropriate for implementation in a traffic signal module, if the power requirements of such systems do not conflict with ENERGY STAR requirements.
- Mechanisms for appropriate dimming of LED traffic signal modules to reduce glare and provide modest energy savings could be implemented, and perhaps even to temporarily increase signal intensity during conditions of reduced visibility such as fog or sun phantom. These could use similar sensors as those that might monitor useful life of LED signal modules.
- LED traffic signal module manufacturers might consider modifying product designs to address the several common failure modes that were identified in the present study: simplifying start-up circuitry, selecting robust circuitry components, different grouping of LEDs in arrays, and relocating high-power electrical components likely to produce excess heat. Indeed, the analysis of similar products with different dates of manufacture suggests that such improvements are already underway.
- Improved characterization of long-term performance and reliability of LED traffic signal modules is necessary in order to determine with precision the optimum replacement strategies. The present analyses suggest that group replacement does appear to have cost benefits over spot replacement under many circumstances, but identifying the optimal replacement intervals will depend upon the life and reliability characteristics of LED traffic signal modules. Transportation agencies should consider developing programs to collect long-term performance data for their LED traffic signal modules, even on a limited sample basis.
- While not within the scope of the present project, compatibility between LED traffic signal modules and the control equipment used to operate them, primarily based on operation of incandescent traffic signals, should be improved, as identified by Urbanik (2008). Retrofit solutions, which attempt to make LED systems behave like

incandescent systems so that they will be compatible with older control equipment, have been demonstrated to have compatibility and reliability problems and should be addressed in future research.

In summary, LED traffic signal modules have largely lived up to their promise for increasing the energy-efficiency of the nation's traffic signal system and have most likely reduced the costs of labor associated with traffic signal maintenance. Generally speaking, the current specifications from the ITE (2005) for photometric and colorimetric performance of traffic signals are sufficient to ensure sufficient visual performance in terms of reaction times, detection probability, and color identification for color-normal and many color-deficient observers.

A number of failure modes for LED traffic signal modules have been identified and can be addressed by improvements in designs. As described in the previous chapter, LED signal module manufacturers have modified product designs in the past to solve some of the problems identified in the failure analysis conducted for this study. Solutions to many of the issues identified presently may be well on their way to being implemented, but a large base of installed signals using several of the earlier product designs exists and will need to be dealt with by transportation agencies.

Finally, the cost analysis of group versus spot replacement strategies suggests that, subject to some uncertainty in the failure rates for LED traffic signal modules, group replacement, combined with some recovery of replaced modules for the necessary spot replacements that might occur even with a group replacement program, can reduce agency costs. A replacement period of around 8 years if a 10-year operating life is expected, or of around 6 years if a 7-year operating life is expected, will probably reduce overall long-term replacement costs. In the former case, about 12% of signal modules could be replaced each year; in the latter, about 17% would be replaced each year.

REFERENCES

Andersen, C., "Impact of Using Light Emitting Diodes on Recognition of Colored Light Signals by Color Vision Deficient Drivers." Transportation Research Board 16th Biennial Symposium on Visibility and Simulation, Iowa City, Ia. (2002).

Behura, N., "A Survey of Maintenance Practices of Light-Emitting Diode Traffic Signals and Some Recommended Guidelines." *ITE Journal*, Vol. 77, No. 4 (2007) p. 18.

Bullough, J. D., "Onset Times and the Detection of Colored Signal Lights." *Transportation Research Record 1918* (2005) pp. 123-127.

Bullough, J. D., "Research Recap: Are Yellow Traffic Signals Brighter Than They Need to Be?" *Lighting Design and Application*, Vol. 32, No. 12 (2002) pp. 18-21.

Bullough, J. D., H. Yan, and J. Van Derlofske, "Effects of Sweeping, Color and Luminance Distribution on Response to Automotive Stop Lamps." *Society of Automotive Engineers 2002 Transactions Journal of Passenger Cars - Mechanical Systems*, Vol. 111, No. 6 (2003) pp. 1294-1298.

Bullough, J. D., *Lighting Answers: Light Emitting Diode Lighting Systems*. National Lighting Product Information Program, Rensselaer Polytechnic Institute, Troy, N.Y. (2003).

Bullough, J. D., P. R. Boyce, A. Bierman, C. M. Hunter, K. M. Conway, A. Nakata, and M. G. Figueiro, "Traffic Signal Luminance and Visual Discomfort at Night." *Transportation Research Record 1754* (2001) pp. 42-47.

Bullough, J. D., P. R. Boyce, A. Bierman, K. M. Conway, K. Huang, C. P. O'Rourke, C. M. Hunter, and A. Nakata, "Response to Simulated Traffic Signals Using Light-Emitting Diode and Incandescent Sources." *Transportation Research Record 1724* (2000) pp. 39-46.

Bullough, J. D., Z. Yuan, and M. S. Rea, "Perceived Brightness of Incandescent and LED Aviation Signal Lights." *Aviation, Space and Environmental Medicine*, Vol. 78, No. 9 (2007) pp. 893-900.

City of Little Rock, *Conventional Versus LED Traffic Signals: Operational Characteristics and Economic Feasibility*. Arkansas Department of Economic Development, Little Rock, Ark. (2003).

Cohn, T. E., D. Greenhouse, and R. Knowles, *Alternative Traffic Signal Illumination*, California Partners for Advanced Transit and Highways, Sacramento, Calif. (1998).

Cole, B. L., "The Handicap of Abnormal Colour Vision." *Clinical and Experimental Optometry*, Vol. 87, No. 4-5 (2004) pp. 258-275.

ENERGY STAR, *ENERGY STAR Program Requirements for Traffic Signals*, U.S. Environmental Protection Agency, Washington, D.C. (2003).

Fisher, A. J., and B. L. Cole, "The Photometric Requirements of Vehicular Traffic Signal Lanterns." Proceedings of the Australian Road Research Board, Victoria, Australia (1975) pp. 246-265.

Freedman, M., "Traffic Signal Brightness Requirements for the Nighttime Driving Environment." *Transportation Research Circular 297* (1985) pp. 22–23.

Freedman, M., *Visibility Performance Requirements for Vehicular Traffic Signals*, NCHRP Project 5-15 Report, National Cooperative Highway Research Program, Washington, D.C. (2001).

Huang, M. K., J. D. Bullough, P. R. Boyce, and A. Bierman, "Detection and Identification of Light-Emitting Diode Traffic Signals by Protan Observers." *Transportation Research Record 1844* (2003) pp. 52-58.

Institute of Transportation Engineers, "Vehicle Traffic Control Signal Heads: Light Emitting Diode (LED) Circular Signal Supplement," Institute of Transportation Engineers, Washington, D.C. (2005).

Institute of Transportation Engineers, "Vehicle Traffic Control Signal Heads Part 2, Light Emitting Diode (LED) Vehicle Signal Module (Interim)," Institute of Transportation Engineers, Washington, D.C. (1998).

Iwasaki, R. H., "LED Traffic Signal Modules as an Incandescent Lamp Alternative." *ITE Journal*, Vol. 73, No. 4 (2003) pp. 42-45.

Kurniawan, B. A., Y. Nakashima, and M. Takamatsu, "Analysis of Visual Perception of Light Emitting Diode Brightness in Dense Fog with Various Droplet Sizes." *Optical Review*, Vol. 15, No. 3 (2008) pp. 166-172.

Miller, K. A., and N. J. Zaidi, "Measuring LED Intensity to Track LED Degradation." International Municipal Signal Association 107th Annual Conference, Arlington, Va. (2002).

Rea, M. S. (editor), *IESNA Lighting Handbook: Reference and Application*, 9th ed. Illuminating Engineering Society of North America, New York, N.Y. (2000).

Starr, R. A., W. H. Sandberg, and Y. Guan, "Does Color Blindness Affect the Perception of Green LED Signal Indications?" *ITE Journal*, Vol. 74, No. 8 (2004) pp. 32-42.

Susquehanna Economic Development Association-Council of Governments, *LED Traffic Signal Conversion Project*. Susquehanna Economic Development Association-Council of Governments, Lewisburg, Penna. (2008).

Urbanik, T., *LED Traffic Signal Monitoring, Maintenance, and Replacement Issues*, NCHRP Synthesis 337, Transportation Research Board, Washington, D.C. (2008).

Whillans, M. G., "Colour-Blind Drivers' Perception of Traffic Signals." *Canadian Medical Association Journal*, Vol. 128, No. 10 (1983) pp. 1187-1189.

Wilkins, D. J., "The Bathtub Curve and Product Failure Behavior, Part One: The Bathtub Curve, Infant Mortality and Burn-In." *Reliability HotWire*, No. 21 (2002).

Wyszecki, G., and W. S. Stiles, *Color Science*, 2nd edition, Wiley, New York, N.Y. (1982).