

Aggregate Properties and the Performance of Superpave-Designed Hot-Mix Asphalt

DETAILS

90 pages | | PAPERBACK

ISBN 978-0-309-08825-1 | DOI 10.17226/13844

AUTHORS

Transportation Research Board

BUY THIS BOOK

FIND RELATED TITLES

Visit the National Academies Press at NAP.edu and login or register to get:

- Access to free PDF downloads of thousands of scientific reports
- 10% off the price of print titles
- Email or social media notifications of new titles related to your interests
- Special offers and discounts



Distribution, posting, or copying of this PDF is strictly prohibited without written permission of the National Academies Press. (Request Permission) Unless otherwise indicated, all materials in this PDF are copyrighted by the National Academy of Sciences.

NATIONAL COOPERATIVE HIGHWAY RESEARCH PROGRAM

NCHRP REPORT 539

**Aggregate Properties and
the Performance of Superpave-
Designed Hot Mix Asphalt**

BRIAN D. PROWELL
JINGNA ZHANG

AND

E. RAY BROWN
National Center for Asphalt Technology
Auburn, AL

SUBJECT AREAS

Materials and Construction

Research Sponsored by the American Association of State Highway and Transportation Officials
in Cooperation with the Federal Highway Administration

TRANSPORTATION RESEARCH BOARD

WASHINGTON, D.C.
2005
www.TRB.org

NATIONAL COOPERATIVE HIGHWAY RESEARCH PROGRAM

Systematic, well-designed research provides the most effective approach to the solution of many problems facing highway administrators and engineers. Often, highway problems are of local interest and can best be studied by highway departments individually or in cooperation with their state universities and others. However, the accelerating growth of highway transportation develops increasingly complex problems of wide interest to highway authorities. These problems are best studied through a coordinated program of cooperative research.

In recognition of these needs, the highway administrators of the American Association of State Highway and Transportation Officials initiated in 1962 an objective national highway research program employing modern scientific techniques. This program is supported on a continuing basis by funds from participating member states of the Association and it receives the full cooperation and support of the Federal Highway Administration, United States Department of Transportation.

The Transportation Research Board of the National Academies was requested by the Association to administer the research program because of the Board's recognized objectivity and understanding of modern research practices. The Board is uniquely suited for this purpose as it maintains an extensive committee structure from which authorities on any highway transportation subject may be drawn; it possesses avenues of communications and cooperation with federal, state and local governmental agencies, universities, and industry; its relationship to the National Research Council is an insurance of objectivity; it maintains a full-time research correlation staff of specialists in highway transportation matters to bring the findings of research directly to those who are in a position to use them.

The program is developed on the basis of research needs identified by chief administrators of the highway and transportation departments and by committees of AASHTO. Each year, specific areas of research needs to be included in the program are proposed to the National Research Council and the Board by the American Association of State Highway and Transportation Officials. Research projects to fulfill these needs are defined by the Board, and qualified research agencies are selected from those that have submitted proposals. Administration and surveillance of research contracts are the responsibilities of the National Research Council and the Transportation Research Board.

The needs for highway research are many, and the National Cooperative Highway Research Program can make significant contributions to the solution of highway transportation problems of mutual concern to many responsible groups. The program, however, is intended to complement rather than to substitute for or duplicate other highway research programs.

Note: The Transportation Research Board of the National Academies, the National Research Council, the Federal Highway Administration, the American Association of State Highway and Transportation Officials, and the individual states participating in the National Cooperative Highway Research Program do not endorse products or manufacturers. Trade or manufacturers' names appear herein solely because they are considered essential to the object of this report.

NCHRP REPORT 539

Project 9-35

ISSN 0077-5614

ISBN 0-309-08825-9

Library of Congress Control Number 2005926327

© 2005 Transportation Research Board

Price \$23.00

NOTICE

The project that is the subject of this report was a part of the National Cooperative Highway Research Program conducted by the Transportation Research Board with the approval of the Governing Board of the National Research Council. Such approval reflects the Governing Board's judgment that the program concerned is of national importance and appropriate with respect to both the purposes and resources of the National Research Council.

The members of the technical committee selected to monitor this project and to review this report were chosen for recognized scholarly competence and with due consideration for the balance of disciplines appropriate to the project. The opinions and conclusions expressed or implied are those of the research agency that performed the research, and, while they have been accepted as appropriate by the technical committee, they are not necessarily those of the Transportation Research Board, the National Research Council, the American Association of State Highway and Transportation Officials, or the Federal Highway Administration, U.S. Department of Transportation.

Each report is reviewed and accepted for publication by the technical committee according to procedures established and monitored by the Transportation Research Board Executive Committee and the Governing Board of the National Research Council.

Published reports of the

NATIONAL COOPERATIVE HIGHWAY RESEARCH PROGRAM

are available from:

Transportation Research Board
Business Office
500 Fifth Street, NW
Washington, DC 20001

and can be ordered through the Internet at:

<http://www.national-academies.org/trb/bookstore>

Printed in the United States of America

THE NATIONAL ACADEMIES

Advisers to the Nation on Science, Engineering, and Medicine

The **National Academy of Sciences** is a private, nonprofit, self-perpetuating society of distinguished scholars engaged in scientific and engineering research, dedicated to the furtherance of science and technology and to their use for the general welfare. On the authority of the charter granted to it by the Congress in 1863, the Academy has a mandate that requires it to advise the federal government on scientific and technical matters. Dr. Ralph J. Cicerone is president of the National Academy of Sciences.

The **National Academy of Engineering** was established in 1964, under the charter of the National Academy of Sciences, as a parallel organization of outstanding engineers. It is autonomous in its administration and in the selection of its members, sharing with the National Academy of Sciences the responsibility for advising the federal government. The National Academy of Engineering also sponsors engineering programs aimed at meeting national needs, encourages education and research, and recognizes the superior achievements of engineers. Dr. William A. Wulf is president of the National Academy of Engineering.

The **Institute of Medicine** was established in 1970 by the National Academy of Sciences to secure the services of eminent members of appropriate professions in the examination of policy matters pertaining to the health of the public. The Institute acts under the responsibility given to the National Academy of Sciences by its congressional charter to be an adviser to the federal government and, on its own initiative, to identify issues of medical care, research, and education. Dr. Harvey V. Fineberg is president of the Institute of Medicine.

The **National Research Council** was organized by the National Academy of Sciences in 1916 to associate the broad community of science and technology with the Academy's purposes of furthering knowledge and advising the federal government. Functioning in accordance with general policies determined by the Academy, the Council has become the principal operating agency of both the National Academy of Sciences and the National Academy of Engineering in providing services to the government, the public, and the scientific and engineering communities. The Council is administered jointly by both the Academies and the Institute of Medicine. Dr. Ralph J. Cicerone and Dr. William A. Wulf are chair and vice chair, respectively, of the National Research Council.

The **Transportation Research Board** is a division of the National Research Council, which serves the National Academy of Sciences and the National Academy of Engineering. The Board's mission is to promote innovation and progress in transportation through research. In an objective and interdisciplinary setting, the Board facilitates the sharing of information on transportation practice and policy by researchers and practitioners; stimulates research and offers research management services that promote technical excellence; provides expert advice on transportation policy and programs; and disseminates research results broadly and encourages their implementation. The Board's varied activities annually engage more than 5,000 engineers, scientists, and other transportation researchers and practitioners from the public and private sectors and academia, all of whom contribute their expertise in the public interest. The program is supported by state transportation departments, federal agencies including the component administrations of the U.S. Department of Transportation, and other organizations and individuals interested in the development of transportation. www.TRB.org

www.national-academies.org

COOPERATIVE RESEARCH PROGRAMS STAFF FOR NCHRP REPORT 539

ROBERT J. REILLY, *Director, Cooperative Research Programs*
CRAWFORD F. JENCKS, *Manager, NCHRP*
EDWARD T. HARRIGAN, *Senior Program Officer*
EILEEN P. DELANEY, *Director of Publications*
ANDRÉA BRIERE, *Associate Editor*

NCHRP PROJECT 9-35 PANEL Field of Design—Area of Pavements

LONNIE S. INGRAM, *Kansas DOT (Chair)*
ERVIN L. DUKATZ, JR., *Mathy Construction, Onalaska, WI*
CHARLES R. MAREK, *Vulcan Materials Company, Birmingham, AL*
JULIE E. NODES, *Arizona DOT*
JOHN D'ANGELO, *FHWA Liaison Representative*
FREDERICK HEJL, *TRB Liaison Representative*

AUTHOR ACKNOWLEDGMENTS

The research reported herein was performed under NCHRP Project 9-35 by the National Center for Asphalt Technology, Auburn University. Brian D. Prowell, Assistant Director, National Center for Asphalt Technology, was the principal investigator. The other author of this report was Jingna Zhang, Research Engineer, at the National Center for Asphalt Technology. E. Ray Brown, Director, National Center for Asphalt Technology, provided guidance and review.

The authors acknowledge the contributions of the Aggregate Industry Advisory Panel—David Jahn (formerly of Martin Marietta Materials, Inc.), Don Powell of Vulcan Materials Company, and Randy Weingart of Luck Stone Corporation—who provided information, guidance, and review to portions of the report.

FOREWORD

*By Edward T. Harrigan
Staff Officer
Transportation Research
Board*

This report presents a critical review of the technical literature available since the conclusion of the Strategic Highway Research Program in 1993 on the impact of the aggregate properties specified by the Superpave mix design method on the performance of hot mix asphalt. The report will be of particular interest to materials engineers in state highway agencies, as well as to materials supplier and paving contractor personnel responsible for the production of aggregates and hot mix asphalt.

The performance of hot mix asphalt (HMA) is largely determined by the characteristics of its constituents: asphalt binder and aggregate. In developing the Superpave mix design method, the Strategic Highway Research Program (SHRP, 1987–1993) targeted the properties of asphalt binders and HMA and their effects on pavement performance. However, in lieu of a formal aggregate research program, a group of acknowledged experts in the areas of aggregate production and behavior and HMA mix design developed—through the use of a modified Delphi process—the set of recommended aggregate criteria in the original Superpave mix design method that were subsequently specified in AASHTO MP2, *Superpave Volumetric Mix Design*. In its original form, this specification presented aggregate gradation control points and restricted zone boundaries as well as requirements for aggregate consensus properties such as coarse aggregate angularity and sand equivalent.

Under NCHRP Project 9-35, “Aggregate Properties and Their Relationship to the Performance of Superpave-Designed HMA: A Critical Review,” the National Center for Asphalt Technology (NCAT) at Auburn University was tasked with reviewing the technical literature and research in progress dealing with the development, evaluation, and validation of the Superpave aggregate criteria in AASHTO MP2 and other proposed criteria, with the goals of (1) identifying those criteria for which experimental results demonstrate positive relationships with HMA performance and (2) estimating the significance of any such relationships. Further, NCAT surveyed current state aggregate specifications to identify deviations from the original Superpave aggregate criteria and document the reasons for the deviations, if available, and their effect on HMA performance. Finally, the agency reviewed materials and performance data from relevant field experiments, including the LTPP SPS-1, 5, and 9 experiments and the WesTrack, FHWA ALF, MnROAD, and NCAT Test Track studies. These results were analyzed with the objective of accepting or rejecting relationships between aggregate criteria and HMA performance identified from the technical literature.

NCAT found that experimental support for the consensus aggregate properties specified in the Superpave mix design method is mixed. Coarse aggregate angularity is strongly related to rutting resistance. However, there is little research to support the need for two-fractured-face counts in excess of 95 percent. Extreme levels (>10% of 5:1 ratio) of flat and elongated particles are likely undesirable in HMA, but no clear

relationship exists for 20 to 40% exceeding a 3:1 ratio. The test for uncompacted voids in fine aggregate is a reasonable measure of fine aggregate angularity (FAA), but the present FAA criteria are likely too restrictive. No relationship can be corroborated between the presence of clay-like particles in aggregate (as measured by the sand equivalent) and HMA performance, but this lack may be related to the inadequacy of the present test method. Similar mixed results were found for the aggregate source properties specified in the Superpave mix design method. No relationship could be established between the Los Angeles abrasion test results and long-term wear of HMA pavement surfaces. The magnesium sulfate soundness and Micro-Deval abrasion loss tests are highly correlated, and there is a demonstrated relationship between Micro-Deval results and pavement particle abrasion. Finally, available experiment results do not demonstrate any difference in rutting resistance between coarse- and fine-graded Superpave mix designs.

The project final report presents the detailed results of the critical review and analysis in seven chapters and an appendix; this published report contains the complete final report.

This report has been referred to the TRB Mixtures and Aggregate Expert Task Group for its review and possible recommendation to the AASHTO Highway Subcommittees on Materials as support for revision of selected specifications and methods.

CONTENTS

- 1 SUMMARY**
- 12 CHAPTER 1 Introduction and Research Approach**
 - 1.1 Introduction, 12
 - 1.2 Objective, 13
 - 1.3 Scope, 13
- 14 CHAPTER 2 State of Practice**
 - 2.1 Introduction, 14
 - 2.2 Coarse Aggregate Angularity, 14
 - 2.2.1 Background, 14
 - 2.2.2 Relationship Between Percent Coarse Aggregate Fractured Faces and Performance, 15
 - 2.2.3 Precision of ASTM D5821, 16
 - 2.2.4 Alternative Methods of Measuring Coarse Aggregate Angularity, 16
 - 2.2.5 Summary of Research Related to Coarse Aggregate Angularity, 18
 - 2.3 Flat and Elongated Particles, 19
 - 2.3.1 Background, 19
 - 2.3.2 Relationship Between F&E and Performance, 19
 - 2.3.3 Precision of F&E Tests, 22
 - 2.3.4 Summary of Research Related to F&E, 23
 - 2.4 Methods of Measuring FAA and Their Relationship to Performance, 24
 - 2.4.1 Introduction, 24
 - 2.4.2 Uncompacted Voids Content in Fine Aggregate, 24
 - 2.4.3 Alternative Methods of Measuring FAA, 25
 - 2.4.4 Relationships Between Fine Aggregate Shape, Angularity, and Texture and HMA Performance, 26
 - 2.4.5 Precision of AASHTO T304, 34
 - 2.4.6 Summary of Findings on Fine Aggregate Texture and Angularity, 34
 - 2.5 Imaging Methods for the Assessment of Aggregate Shape, Angularity, and Texture, 35
 - 2.5.1 Introduction, 35
 - 2.5.2 Video Imaging Systems, 35
 - 2.5.3 Image Analysis, 37
 - 2.6 Tests for Aggregate Properties Related to Moisture Damage, 39
 - 2.6.1 Introduction, 39
 - 2.6.2 Sand Equivalent Test, 39
 - 2.6.3 Plasticity Index, 39
 - 2.6.4 Methylene Blue Test, 39
 - 2.6.5 Surface Free Energy Theory, 40
 - 2.6.6 Net Adsorption Test, 40
 - 2.6.7 Other Aggregate Tests Related to Moisture Damage, 41
 - 2.6.8 Summary of Aggregate Tests Related to Moisture Damage, 41
 - 2.7 Tests Related to Aggregate Durability, 42
 - 2.7.1 Aggregate Tests Related to Abrasion Resistance and Breakdown, 42
 - 2.7.2 Aggregate Tests Related to Weathering and Freeze-Thaw Durability, 48
 - 2.7.3 Aggregate Properties Related to Polishing and Frictional Resistance, 49
 - 2.7.4 Summary of Tests Related to Aggregate Durability, 49
 - 2.8 Effect of Aggregate Grading on HMA Properties, 50
 - 2.8.1 Methods for Analyzing Gradations, 50
 - 2.8.2 Effect of the Restricted Zone on HMA Performance, 51
 - 2.9 Effect of Aggregate Fines and Fillers on HMA Performance, 52
 - 2.9.1 Research on Fines and Fillers, 52
 - 2.9.2 Summary of Research Related to Fines and Fillers, 55
 - 2.10 Effect of Crushing Operations on Aggregate Properties, 55
 - 2.10.1 Types of Crushers, 56
 - 2.10.2 Factors Affecting Aggregate Shape, 57
 - 2.10.3 Applications of Crushers, 58
 - 2.10.4 Influence of Shape on Performance, 58

60	CHAPTER 3 Survey of Current State Agency Specifications
3.1	Introduction, 60
3.2	Superpave Consensus Aggregate Properties, 60
3.2.1	Sand Equivalent Test, 60
3.2.2	Fine Aggregate Angularity, 60
3.2.3	Coarse Aggregate Angularity, 62
3.2.4	Flat and Elongated Particles, 63
3.3	Source Properties, 63
3.3.1	Introduction, 63
3.3.2	LA Abrasion Test, 64
3.3.3	Sulfate Soundness, 64
3.4	Mix Design Properties, 65
3.4.1	Gradation, 65
3.4.2	Aggregate Specific Gravity, 65
3.5	Summary of Agency Specification Survey, 66
67	CHAPTER 4 Review of Performance Data from Field Test Sections and Full-Scale Accelerated Testing
4.1	LTPP, 67
4.2	MnRoad, 67
4.3	WesTrack, 67
4.4	2000 NCAT Test Track, 69
4.4.1	Effect of Gradation, 69
4.4.2	Relationship Between Aggregate Properties and Performance, 70
4.5	Summary of Data from In-Service Pavements and Accelerated Load Facilities, 71
72	CHAPTER 5 Future Research Needs
5.1	Introduction, 72
5.2	The Relationship Between Test Methods to Characterize Aggregate Shape, Texture, and Angularity and Performance of HMA, 72
5.2.1	Laboratory Evaluation, 72
5.2.2	Field Evaluation, 73
5.3	The Relationship Between the Compacted Aggregate Resistance Test and Rutting Performance of HMA, 73
5.3.1	CAR Test Parameters, 73
5.3.2	Laboratory Evaluation, 73
5.3.3	Field Evaluation, 73
74	CHAPTER 6 Conclusions and Recommendations
6.1	Consensus Aggregate Properties, 74
6.1.1	Coarse Aggregate Angularity, 74
6.1.2	Fine and Elongated Particles, 74
6.1.3	Fine Aggregate Angularity, 74
6.1.4	Sand Equivalent, 75
6.2	Source Properties, 75
6.2.1	LA Abrasion, 75
6.2.2	Sulfate Soundness, 75
6.3	Gradation, 75
6.4	Aggregate Production, 75
6.5	Long-Term Pavement Studies and Accelerated Testing, 76
77	REFERENCES
85	GLOSSARY
86	APPENDIX NCHRP Project 9-35 Aggregate Specification Survey

AGGREGATE PROPERTIES AND THE PERFORMANCE OF SUPERPAVE-DESIGNED HOT MIX ASPHALT

SUMMARY

Mineral aggregates make up between 80% and 90% of the total volume or 94% to 95% of the mass of hot mix asphalt (HMA). For this reason, it is important to maximize the quality of the mineral aggregates to ensure the proper performance of our nation's roadways. The quality of mineral aggregates for road-paving materials has generally been specified by the toughness, soundness (durability), cleanliness, particle shape, angularity, surface texture, and absorption.

The Superpave[®] mix design method is a product of the Strategic Highway Research Program (SHRP). Research to investigate aggregate's contribution to pavement performance was intentionally excluded from the SHRP Asphalt Research Program. Instead, the aggregate gradations and physical properties included in the Superpave mix design method were developed through the use of a modified Delphi approach (1).* The Delphi process is designed to ascertain the consensus of a group of experts while avoiding some of the negative aspects of group dynamics. The final results of the modified Delphi process used by SHRP included aggregate properties, test methods to determine those properties, and specification criteria. Gradation limits were included as part of the aggregate properties. The new gradation limits included definitions for nominal maximum and maximum aggregate size, control points for various nominal maximum aggregate sizes, and the restricted zone. The remaining aggregate physical properties were divided into two categories: consensus and source. The consensus properties—including coarse aggregate angularity, flat and elongated particles, fine aggregate angularity, and sand equivalent—were chosen to ensure the aggregate quality was sufficient to provide satisfactory HMA performance for the design traffic level. Specification values were to be uniform throughout the United States without regard for locally available materials. The specification values for the source properties, including LA abrasion, sulfate soundness, and deleterious materials, were to be set by the agency. This was done to allow for variances in locally available materials. Finally, the modified Delphi process identified volumetric properties of the resulting HMA mix including air voids, voids in mineral aggregate (VMA), voids filled with asphalt, and dust-to-asphalt proportion. The aggregate bulk specific gravity is required to calculate VMA, and the aggregate fines content is required to calculate dust-to-asphalt proportion.

*See Summary References.

Prior to the development of the Superpave mix design method, the aforementioned aggregate properties had not been applied in concert. Some agencies found that the Superpave aggregate specifications precluded the use of materials with long performance histories, particularly with regard to gradation. Other agencies found the consensus aggregate properties prevented the use of locally available materials. Others questioned the precision of certain tests. Determination of aggregate bulk specific gravity for calculation of VMA was a concern for quality control/quality assurance testing during production. Since the conclusion of SHRP, these concerns have resulted in several national research studies and in numerous smaller studies to better define the need for various aggregate properties as well as the interaction among the properties. Evaluation of aggregate properties has also been included in some field and accelerated performance studies.

Based upon performance histories of locally available materials or research projects conducted to address concerns about the aggregate specifications included in AASHTO M323, numerous agencies have modified their aggregate specifications for Superpave-designed HMA. Often this experience is not shared with other agencies that are using similar materials. A consensus among the states, based on their experience, may indicate the need to alter aggregate test procedures or specifications on a national basis.

The objective of this study (NCHRP Project 9-35) was to review the technical literature and ongoing research to identify the consensus, source, or other aggregate properties that significantly impact HMA performance. The review also examined the effect of production and crushing operations on aggregate properties. The review concentrated on the effect of aggregate properties on HMA designed using the Superpave methodology, HMA construction, and HMA performance. New innovations in aggregate testing were also examined, especially those related to aggregate shape, angularity, and texture:

To accomplish the research objectives, five tasks were conducted:

- Task 1: State of the Practice,
- Task 2: Survey of Ongoing Research,
- Task 3: Survey of Agency Specifications,
- Task 4: Review of Performance Data from Field Test Sections and Full-Scale Accelerated Testing, and
- Task 5: Final Report.

CONSENSUS AGGREGATE PROPERTIES

The Superpave method includes four consensus aggregate properties: coarse aggregate angularity, flat and elongated particles, uncompacted voids in fine aggregate, and sand equivalent. The consensus properties were to be uniformly adopted by all agencies. Criteria for the consensus properties varied by traffic level and for properties related to rutting depth in the pavement structure. The criteria for the consensus properties were to be applied to the *blend* of aggregates in the mixture.

Coarse Aggregate Angularity

Coarse aggregate angularity was identified by the Delphi panel as the second most important parameter after gradation for the performance of HMA. The current test method, ASTM D5821, is a subjective test that requires the technician to evaluate whether the aggregate has fractured faces. The test method cannot distinguish between

the angularity of aggregates with 100% two or more fractured faces (most quarried aggregates). As such, NCHRP Project 4-19 (published as *NCHRP Report 405: Aggregate Tests Related to Asphalt Concrete Performance in Pavements* [2]) recommended AASHTO TP56, “Uncompacted Voids in Coarse Aggregate,” as a replacement. AASHTO TP56 combines the effects of aggregate shape, angularity, and texture. To date, AASHTO TP56 has not been adopted by state agencies. ASTM D5821, or a similar procedure, is still used by 83% of the responding agencies. The criteria for coarse aggregate angularity are based in part on work conducted by Cross and Brown (3) in the National Rutting Study. Only 39% of the agencies that use ASTM D5821 specify the criteria outlined in the Superpave method (AASHTO M323). Six states have lowered the fractured-face requirements. This is most likely in recognition of the fact that it is nearly impossible to achieve 100% particles with two or more crushed faces with crushed gravel sources. Although there is extensive research that indicates improved rut resistance with increased percentages of fractured faces, little work has been done to investigate the effect at high levels of fractured faces (between 95% and 100%). Hand et al. (4) concluded that coarse aggregate angularity did not have an effect on the rutting performance of the WesTrack mixtures. Two coarse aggregate sources were used at WesTrack: the original was crushed gravel having 98% one fractured face and 96% two fractured faces, and the second was a crushed andesite with 100% one and two fractured faces.

The coarse aggregate angularity test appears to be useful for evaluating gravel sources in terms of rutting potential. The current test method is highly subjective. Based on the findings evaluated and current agency specifications, 95% two crushed faces would appear to be a more reasonable target for high traffic pavements (greater than 30 million equivalent single axle loads [ESALs]). Specifications in Arkansas, Louisiana, Mississippi, and Utah currently support a small tolerance for the percent two fractured faces for high traffic levels.

Flat and Elongated Particles

While the asphalt industry believes that excessive flat and elongated particles are undesirable, perfectly cubical aggregates may also be undesirable. The Superpave method specifies ASTM D4791, “Standard Test Method for Flat Particles, Elongated Particles, or Flat and Elongated Particles,” to evaluate aggregate shape with criteria for a maximum percentage (10% by weight) exceeding the 5:1 ratio of maximum to minimum dimension.

A limited number of studies have been conducted to relate the percentage of flat and elongated particles to performance since the implementation of the Superpave method. None of the studies have addressed the relationship between flat and elongated particle performance near the existing specification level of 10% particles exceeding the 5:1 ratio of maximum to minimum particle dimension. The research conducted to date generally supports the following:

- Percentage of flat and elongated particles changes with handling of the stockpile and mixing.
- Aggregate breakdown during compaction increases for higher percentages of flat and elongated particles.
- VMA generally increases with increasing percent flat and elongated particles.
- There does not appear to be a relationship between the percentage of flat and elongated particles exceeding the 3:1 ratio in the range of approximately 10% to 40% and performance.

- ASTM D4791 is a highly variable test procedure. Alternative methods of determining the percentage of flat and elongated particles should be developed. This variability may mask relationships with performance.

ASTM D4791 or a similar procedure is specified by 86% of the responding agencies. Sixty-three percent of the state agencies who use ASTM D4791 specify the same criteria as AASHTO M323 (<10% particles exceeding the 5:1 ratio for traffic levels in excess of 0.3 million ESALs). Seven states specify 3:1 criteria for Superpave criteria. Five states allow 20% maximum, one state allows 10% maximum, and a final state specifies flat or elongated particles. It should again be noted that research studies have been unsuccessful in relating percentages of flat and elongated particles at the 3:1 ratio to performance. However, testing flat and elongated particles at the 3:1 or even 2:1 ratio probably provides a better indication of the shape of the source and would more readily identify changes in shape resulting from the crushing process.

The current test method for flat and elongated particles, ASTM D4791, is highly variable, particularly at low percentages of flat and elongated particles (typically found at the 5:1 ratio). The percentage of flat and elongated particles has been related to volumetric properties; therefore, changes in percentages of flat and elongated particles may be related to changes in volumetric properties. However, flat and elongated aggregate tests performed at the 5:1 ratio are generally insensitive to production changes in aggregate shape. Based on research conducted on aggregate having 10% to 40% flat and elongated particles exceeding the 3:1 ratio, there is no evidence that these levels are detrimental to performance. However, monitoring the percentage of flat and elongated particles that exceed the 3:1 or 2:1 ratio would provide more information about production changes in aggregate shape and the changes' influence on volumetric properties. The 3:1 criteria adopted by six states (five states 20% maximum and one state 10% maximum) are probably more restrictive than necessary from a performance standpoint.

Fine Aggregate Angularity

To measure the angularity of fine aggregate, the Superpave method specifies AASHTO T304, "Uncompacted Void Content in Fine Aggregate, Method A." The test is included to ensure that there is sufficient internal friction—resulting from particle shape, angularity, and texture—to provide rut-resistance in the HMA. The uncompacted voids test is an indirect measure of aggregate shape, angularity, and texture and works under the assumption that particles that are more flat and elongated, are more angular, have more texture, or are a combination thereof will not pack as tightly and therefore will have a higher uncompacted void content.

The uncompacted voids test may be the most controversial of the consensus properties, and several concerns have been expressed regarding its use. The primary concern is that some fine aggregates, which are 100% crushed, do not meet the minimum requirements (>45%) for mixes used in the upper 100 mm of the pavement structure for traffic levels greater than 3 million ESALs. Typically, these are extremely cubical limestone sources. A second concern is that particles that pass the 4.75-mm sieve but are retained on the 2.36-mm sieve are not evaluated for angularity or shape under the current Superpave aggregate properties (5). A third concern is related to the variability of the test procedure and its dependence on the fine aggregate dry bulk specific gravity (5). Finally, there is concern that the fine aggregate angularity test may not be related to the rutting propensity of the HMA mixture.

Twelve studies were discussed in detail. The following is a summary of the key findings of these studies. Numerous test procedures are available to assess fine aggregate

angularity and texture. Several of the imaging techniques and the compacted aggregate resistance (CAR) test appear to be promising. Two studies found fair relationships between the direct shear test (ASTM D3080) and laboratory measures of rutting resistance. However, researchers using the direct shear test have indicated that it is difficult to obtain consistent results. In addition to the new methods examined, to date, the majority of the work to correlate fine aggregate shape and texture to performance has been completed using AASHTO T304 Method A.

The results of studies relating the uncompacted voids content from AASHTO T304 Method A to performance are mixed. Generally, studies indicated a trend between uncompacted voids content and improved rutting performance, but in some cases the trend was weak. Subtle differences in uncompacted voids content can be overwhelmed by the effect of the coarse aggregate or other HMA mixture properties. Several studies supported the 45% uncompacted voids criteria for high traffic, but several also indicated that performance was unclear between 43% and 45% (or higher) uncompacted voids. There is clear evidence that good performing mixes can be designed with uncompacted voids contents between 43% and 45%, but evaluation of these mixes using a rutting performance test is recommended. Although the results for the uncompacted voids tests were mixed, an alternative test was not clearly identified as being related to performance. Also, higher uncompacted void contents generally resulted in higher VMA and lower densities at N_{initial} .

The variability of AASHTO T304 Method A appears to be larger than reported in the test method. Much of this variability appears to be related to variability in the fine aggregate specific gravity measurements used to calculate the uncompacted voids. Ongoing research to improve fine aggregate specific gravity measurements may also benefit AASHTO T304.

Based on the research evaluated, the test for uncompacted voids in fine aggregate appears to be a reasonable screening tool for fine aggregates with respect to their rutting potential. The research supports the fact that some crushed fine aggregates with uncompacted voids contents between 43% and 45% can be used to produce rut-resistant mixtures. Currently, four agencies' specifications allow either uncompacted void contents of 43% or 44% up to 10 million ESALs, one agency allows 44% for all traffic levels, and one agency allows 43% for all traffic levels if the volumetric properties are met.

Further research is recommended to evaluate alternatives to the uncompacted voids test, such as the CAR test. This study should include an examination of the interactions that allow rut-resistant mixes to be produced with uncompacted voids contents between 43% and 45%.

Several new tests are being developed to directly measure aggregate size, shape, angularity, and texture (NCHRP Project 4-30). Measurements are made from digital images or laser scans. These techniques should eliminate subjectivity and improve testing precision. Once the measurement techniques are perfected, additional research will be required to relate these parameters to the performance of HMA and, thereby, to develop criteria. These methods have the potential to replace coarse aggregate angularity, flat and elongated particles, and fine aggregate angularity. However, because of the cost and complexity of the new methods, the existing consensus properties may have applicability in field labs for some time to come.

Sand Equivalent

Many factors influence moisture damage. HMA characteristics (aggregate, asphalt binder, and type of mixture), weather during construction, environmental effects after construction, and pavement surface drainage properties all affect pavement moisture

damage. Aggregate tests related to moisture damage generally fall into two categories: tests to identify clay-like fines and tests that evaluate the surface properties of the aggregate related to the adhesion of the binder to the aggregate.

Clay-like fines may coat the fine aggregate and prevent the asphalt from adhering to the aggregate surface. In the presence of water, such coatings may lead to moisture damage. The Superpave method currently specifies the sand equivalent test (AASHTO T176) to identify clay-like fines in fine aggregate. Controversial results and findings exist for the sand equivalent test. In some cases, the sand equivalent test identifies crusher fines as harmful clay-like particles. The sand equivalent test is specified by 92% of the responding agencies. The majority of the responding agencies have adopted the same criteria specified in AASHTO M323, although several states have more restrictive criteria for low traffic levels.

It appears that the methylene blue test may be the best method to quantify the amount of harmful clays in fine aggregate. However, there is concern that the methylene blue test is too variable for routine specification work and is better suited to research and forensic investigations.

The net adsorption test was developed during SHRP to evaluate the interaction between the asphalt binder and aggregate in the presence of water. However, validation work conducted as part of SHRP indicated a poor predictive ability for the test, and it has not been widely used since. At present, the surface energy techniques appear to be promising. The procedures are relatively new. Results and efforts from NCHRP Project 9-37, "Using Surface Energy Measurements to Select Materials for Asphalt Pavements," can be used to apply the energy surface theory in the future.

SOURCE PROPERTIES

Source properties address two categories: aggregate durability and deleterious materials. Deleterious materials are organics or other unsuitable materials such as coal and lignite. Criteria for source properties were to be set by the specifying agency to allow for regional differences in geology. Aggregate durability generally encompasses two categories of tests: tests that measure aggregate abrasion resistance and breakdown during handling, mixing, laydown, and under traffic and tests that address aggregate weathering when exposed to freezing and thawing or wetting and drying. These tests are employed in concert to ascertain that the aggregate used in the production of HMA will be durable. Specifically, tests related to durability are selected to address the following:

- Aggregate breakdown during handling, mixing, and placement. This breakdown can generally be accounted for in the design process.
- Abrasion or weathering of the aggregates in the pavement structure. Gross aggregate wear or weathering can occur in the form of raveling, popouts, or potholes.
- Freeze-thaw durability, although this is generally less of a concern with HMA as compared with aggregate base or Portland cement concrete because the aggregate particles in HMA should be coated with asphalt.

The Superpave method includes two methods to measure aggregate durability: the Los Angeles (LA) abrasion test and sulfate soundness.

LA Abrasion Test

The LA abrasion test subjects the aggregate sample to impact and crushing. It has been correlated with other impact tests such as the Aggregate Impact Value and Aggre-

gate Crushing value, both of which are British standards. The LA abrasion test is probably most related to the expected breakdown during handling, mixing, and placement. Recent studies have only indicated a fair correlation with in-place performance although early developmental studies indicated better correlations. The LA abrasion test is used by 96% of the responding agencies. Agency specification values range from less than 30% to less than 55% loss, with 40% loss being the most frequently cited specification. Some research has been conducted to evaluate the micro-deval test as an alternative to LA abrasion. However, the two tests measure different deterioration methods. There is no evidence that the LA abrasion test should be replaced for assessing breakdown during construction. Individual agencies may wish to examine their criteria based on other agencies' experience.

Sulfate Soundness

Aggregates can deteriorate from wetting and drying or freezing and thawing cycles. The sulfate soundness test simulates the effects of the expansion of water in the aggregate pores during freezing. Two sulfates can be used in the sulfate soundness test (AASHTO T104): magnesium or sodium. Seventy-five percent of the responding agencies specify sulfate soundness. Sodium sulfate soundness is specified by 64% of these agencies, and magnesium sulfate soundness by 30% of these agencies. Two agencies (6%) allow either magnesium or sulfate soundness. More than 50% of the agencies specifying sodium sulfate soundness specify a maximum loss of 12%. There is no consensus for magnesium sulfate soundness; however, NCHRP Project 4-19 recommended the use of magnesium sulfate soundness with a maximum loss of 18%. Other recent research regarding the sulfate soundness test has been conducted in conjunction with evaluations of the micro-deval test, discussed below.

Micro-Deval Test

The Superpave method did not specify a test method to evaluate the abrasion of aggregates under traffic, although the sulfate soundness test evaluates disintegration of aggregates caused by environmental exposure. Several studies have evaluated the micro-deval test for inclusion as a durability test for aggregates. In the micro-deval test, the aggregate is loaded in a jar with water and a charge of steel shot and then rotated at 100 RPM for 2 hours. This is not an impact test; however, as the aggregate breaks down, abrasive slurry is created in addition to the steel shot.

Although originally intended to assess degradation from freezing and thawing, sulfate soundness tests (AASHTO T104) have been widely used to assess aggregates' resistance to weathering. Several studies indicated good correlations between magnesium sulfate soundness loss and micro-deval abrasion loss (AASHTO TP58). Several studies have also indicated that the strength of some aggregates is significantly lower when wet. The micro-deval test offers improved precision over sulfate soundness. The micro-deval test also indicates abrasion resistance. This suggests that the micro-deval test may be more suitable to predicting aggregates' performance in relation to weathering and abrasion than is the sulfate soundness test. NCHRP Project 4-19 recommended a criterion of a maximum of 18% loss may separate good- and poor-performing aggregates. However, data suggests specifications for micro-deval loss may have to be based on aggregate type. In regions where freeze-thaw is a concern, equipment now exists to perform actual freeze-thaw tests on aggregate, such as the equipment used in AASHTO T103.

AGGREGATE GRADING

The aggregate grading has significant effect on the constructability and performance of HMA mixtures. Numerous research studies have indicated that the restricted zone, included when the Superpave method was originally developed during SHRP, was redundant when considering the other Superpave properties, particularly uncompacted voids in fine aggregate and N_{initial} . This was evidenced by the good historical performance of many agency-used mixes that passed through the restricted zone by specification prior to the adoption of the Superpave method. Based on these studies, the restricted zone was removed from the 2004 AASHTO Superpave specification (AASHTO M323). Data from the 2000 National Center for Asphalt Technology (NCAT) Test Track indicates that fine and coarse gradations can be equally rut resistant.

EFFECTS OF FINES AND FILLERS

It is widely believed that depending on the particle size, fines can act as a filler or an extender of asphalt cement binder. Some fines have a considerable effect on the asphalt cement, making it act as a much stiffer grade when compared with the neat asphalt cement. Early work indicated that both the size of the filler and the asphalt binder composition had an impact on the stiffening effect. As much as a 1,000-fold increase in viscosity of the neat asphalt cement was measured when certain fillers were added to asphalt cement. Some fines may also make HMA mixtures more susceptible to moisture-induced damage.

Numerous studies have evaluated the effects of fines, filler, and mortar on HMA performance in the laboratory and in the field. Efforts to characterize fillers have generally followed three paths: characterization of particle size or packing, binder tests performed on a mortar, or modeling of the overall interaction between the filler and binder.

Several research studies have been conducted to develop suitable test parameters related to particle size or packing to evaluate the fines and fillers. D60 (the particle size of P200 at 60% passing) and methylene blue values were found to be related to rutting, and D10 and methylene blue values to stripping. The modified Rigden voids test has been used to characterize the stiffening potential of baghouse fines. Superpave binder tests including the dynamic shear rheometer, bending beam rheometer, and direct tension test have been used to characterize the fine mortar or voidless mastics properties. Recommended criteria have been developed for fillers for stone matrix asphalt mixtures.

EFFECT OF CRUSHING OPERATIONS ON AGGREGATE PROPERTIES

The implementation of the Superpave method impacted the aggregate industry. Some of the areas that highlighted the importance of crushing operations include the following:

- Requirements for coarse aggregate angularity for high-traffic pavements;
- Increased emphasis on particle shape and specifications for flat and elongated particles using the 3:1 ratio;
- Uniform utilization of product sizes, particularly with the preference for coarse-graded Superpave mixes early in the implementation process; and
- The divergent requirements for aggregate properties for different end users (HMA, hydraulic cement concrete, and base).

For gravel sources, it can be impossible to meet high levels (100% two or more fractured faces) of coarse aggregate angularity for high traffic levels. Fractured faces are produced through the size reduction of the aggregate. If the feed aggregate is broken in half, one fractured face is produced on each of the resulting particles. If the particle size of the gravel feed stock is not large enough to allow significant particle size reduction in the production of the final product size (say, one-third or one-quarter of the feed size), then it is impossible to consistently produce very high levels of fractured faces. Mississippi DOT's specifications account for this reality. Mississippi requires higher percentages of fractured faces for smaller nominal maximum aggregate sizes. These smaller nominal maximum aggregate sizes are typically used in surface mixes where stresses are higher.

Particle shape is affected by the geology of the aggregate as well as the crushing process. Impact type crushers tend to produce the best particle shape. Horizontal shaft impact crushers are only suitable for low abrasion feed; their operation would be cost prohibitive for hard aggregates such as granite. Vertical shaft impact crushers, particularly autogenous ones, can be used on harder aggregates, but they produce a relatively small size reduction. In an autogenous crusher, the rotor propels aggregate particles against a cascade of aggregate particles reducing wear on the crusher liner.

Compression crushers are more commonly used on harder aggregates. A number of factors can improve the shape of aggregate crushed in compression crushers:

- The crusher should be run with a full or choked feed cavity to promote inter-particle crushing.
- Crushers should be operated in closed circuits where a recirculating feed can be used to fill the crusher cavity.
- The reduction ratio should be reduced, which can be accomplished by reducing the feed size or increasing the circulating load.
- The close-side setting should be approximately equal to the desired product size.

Unfortunately, most of the techniques that improve particle shape also generate more fines. Most quarries already produce more fines than they can sell. The majority of the techniques used to improve particle shape also increase production cost. Finally, HMA is just one use for aggregate. In some cases, there are product requirements that are not consistent for HMA, hydraulic cement concrete, and aggregate base. While it would be possible to produce specialty products for each application, this may be cost prohibitive.

REVIEW OF PERFORMANCE DATA FROM FIELD TEST SECTIONS AND FULL-SCALE ACCELERATED TESTING

The earliest Superpave projects were constructed 1992. A number of experimental field sections have been built and documented by agencies. Unfortunately, the consensus and source aggregate properties are generally not documented in these reports.

There are a number of accelerated loading facilities in the United States; however, aggregate properties have not been experimental factors in the majority of testing completed to date. One exception is the Indiana DOT-Purdue University Accelerated Pavement Testing Facility in West Lafayette, Indiana, where a large number of aggregate studies have been completed. In addition, there are three test tracks that have been active since the completion of the Superpave mix design system: Minnesota Road Research Project (MnRoad), WesTrack, and the National Center for Asphalt Technology (NCAT) Test Track.

The Long-Term Pavement Performance (LTPP) Program contains data for more than 773 SPS-1, -5 and -9 HMA sections. The majority of the SPS-9 sections were designed

using the Superpave method. Unfortunately, of the consensus aggregate properties, only the uncompacted void content is currently available in the database (DataPave 3.0) and then only for a limited number of sections. Traffic data is also missing in many cases. A weak relationship ($R^2 = 0.46$) was found between the uncompacted voids content and the measured rut depth divided by the square root of ESALs.

Aggregate properties were not an experimental variable at MnRoad or WesTrack. There were over eight combinations of aggregate types, three nominal maximum aggregate sizes, and a wide range of gradations placed at the 2000 NCAT Test Track. All of the sections performed well. Strong correlations were not evident between aggregate properties and rutting, VMA, construction density, or densification under traffic. Comparisons could be made between the performance of fine and coarse graded mixes using an unmodified binder for three aggregate types. Statistical analysis indicated that gradation (coarse or fine) did not have a significant effect on the rut depth of the pavement sections.

One overall conclusion from the review of in-service and accelerated loading sites was that aggregate property data was not as readily available as expected. Additional efforts need to be made to collect and make readily available aggregate property data from in-service pavements.

FUTURE RESEARCH NEEDS

The results of this review have emphasized the difficult nature of conducting research to relate aggregate properties and HMA performance. It is difficult to isolate the effects of the aggregate properties from other interactions with gradation and mixture volumetric properties. It appears as if the shortcomings of a single property related to rutting resistance can be overcome by other supporting properties.

These interactions emphasize the need for laboratory performance tests for HMA mixtures. If performance tests are adopted that have criteria in which agencies are confident, the overall performance of the mixture could be assessed instead of relying solely on component screening tests. For example, if the blend uncompacted voids in fine aggregate were 43% for a given mixture to be placed on a high-volume road, the rutting properties of this mixture could be tested (at the contractor's expense) to show whether the mix should provide acceptable performance.

There is also a need to emphasize the collection and reporting of aggregate property data for both in-service pavements and accelerated loading facilities. More effort needs to be placed on capturing aggregate property data in national studies related to HMA performance.

Two areas selected for immediate research are an investigation of alternatives to, and specification limits for, the uncompacted voids in fine aggregate tests and the development of performance relationships and criteria for the new imaging methods to measure aggregate shape, angularity, and texture. However, even where the test method may not be in question, there is still room for additional research to refine specification limits for such tests as coarse aggregate angularity, flat and elongated particles (both of which could one day be replaced by imaging), LA abrasion, and micro-deval. Additional refinement of the methylene blue test could make it a likely and more discriminating candidate to replace the sand equivalent test.

SUMMARY REFERENCES

1. Cominsky, R., R.B. Leahy, and E.T. Harrigan. *Level One Mix Design: Materials Selection, Compaction, and Conditioning*, SHRP A-408. Strategic Highway Research Program, National Research Council, Washington, DC, 1994.

2. Kandhal, P.S., and F. Parker, Jr. *NCHRP Report 405: Aggregate Tests Related to Asphalt Concrete Performance in Pavements*, Transportation Research Board, National Research Council, Washington, DC, 1998.
 3. Cross, S.A., and E.R. Brown. "Selection of Aggregate Properties to Minimize Rutting of Heavy Duty Pavements," *Effects of Aggregates and Mineral Fillers on Asphalt Mixture Performance*, ASTM STP 1147. American Society for Testing and Materials, Philadelphia, PA, 1992.
 4. Hand, A.J., J.A. Epps, and P.E. Sebaaly. "Precision of ASTM D5821 Standard Test Method for Determining the Percentage of Fractured Particles in Coarse Aggregate," *Journal of Testing and Evaluation*, American Society for Testing and Materials, Vol. 28, No. 2; 2000; pp. 67–75.
 5. Marek, C.R. White Paper on Fine Aggregate Angularity. Vulcan Materials Company, 2002.
-

CHAPTER 1

INTRODUCTION AND RESEARCH APPROACH

1.1 INTRODUCTION

Mineral aggregates make up between 80% and 90% of the total volume or 94% to 95% of the mass of hot mix asphalt (HMA). For this reason, it is important to maximize the quality of the mineral aggregates to ensure the proper performance of our nation's roadways. The quality of mineral aggregates for road-paving materials has been specified by the toughness, soundness (durability), cleanliness, particle shape, angularity, surface texture, and absorption.

The Superpave mix design method is a product of the Strategic Highway Research Program (SHRP). Research to investigate aggregate's contribution to pavement performance was intentionally excluded from the SHRP Asphalt Research Program. Instead, the aggregate gradations and physical properties included in the Superpave mix design method were developed through the use of a modified Delphi approach (1). The Delphi process is designed to ascertain the consensus of a group of experts while avoiding some of the negative aspects of group dynamics. The Delphi process uses a series of questionnaires to focus the experts' opinions. The use of questionnaires allows the expert panel to remain anonymous and prevents strong-willed individuals from steering the group. To determine the Superpave aggregate gradations and physical properties, SHRP used a modified Delphi process that included two meetings of the group of experts. In total, the process included an initial questionnaire, followed by two face-to-face meetings, followed by two more questionnaires. These are documented in report SHRP A-408 (1).

The final results of the modified Delphi process used by SHRP included aggregate properties, test methods to determine those properties, and specification criteria. Gradation limits were included as part of the aggregate properties. The new gradation limits included definitions for nominal maximum and maximum aggregate size, control points for various nominal maximum aggregate sizes (NMAS), and the restricted zone. The remaining aggregate physical properties were divided into two categories: consensus and source properties. The consensus properties—including coarse aggregate angularity, flat and elongated particles, fine aggregate angularity, and sand equivalent—were chosen to ensure that the aggregate quality was sufficient to provide satisfactory HMA performance for the design traffic level. Specification values were to be uniform throughout the United States with-

out regard for locally available materials. The specification values for the source properties—including Los Angeles (LA) abrasion, sulfate soundness, and deleterious materials—were to be set by the agency. This was done to allow for variances in locally available materials. Finally, the modified Delphi process identified volumetric properties of the resulting HMA mix including air voids, voids in mineral aggregate (VMA), voids filled with asphalt, and dust-to-asphalt proportion. The aggregate bulk specific gravity is required to calculate VMA and the aggregate fines content is required to calculate dust-to-asphalt proportion.

Prior to the development of the Superpave mix design method, the aforementioned aggregate properties had not been applied in concert. Some agencies found that the Superpave aggregate specifications precluded the use of materials with long performance histories, particularly with regard to gradation. Other agencies found the consensus aggregate properties prevented the use of locally available materials. Others questioned the precision of certain tests. Determination of aggregate bulk specific gravity for calculation of VMA was a concern for quality control/quality assurance (QC/QA) testing during production. Since the conclusion of SHRP, these concerns have resulted in several national research studies and in numerous smaller studies to better define the need for various aggregate properties as well as the interaction between the properties.

Three national studies relating aggregate properties to performance have been completed since the conclusion of SHRP; two others are ongoing. NCHRP Project 4-19, "Aggregate Tests Related to Asphalt Concrete Performance in Pavements," (published as *NCHRP Report 405: Aggregate Tests Related to Asphalt Concrete Performance in Pavements* [2]) evaluated currently used and promising new aggregate tests as they relate to the performance of HMA. As a result of the study, a suite of nine tests was recommended: two of the Superpave consensus properties (although one was modified), one of the source properties, and one of gradation analysis. The remaining five tests are different from those currently specified by AASHTO M323. A follow up study, NCHRP Project 4-19(2), "Validation of Performance-Related Tests of Aggregates for Use in Hot-Mix Asphalt Pavements," is ongoing. NCHRP Project 9-14, "Investigation of the Restricted Zone in the Superpave Aggregate Gradation Specification," (published as *NCHRP Report 464: The Restricted Zone in the Superpave*

Aggregate Gradation Specification [3]) determined that the restricted zone was a redundant requirement when used in conjunction with the other aggregate and volumetric properties specified in AASHTO M323. Pooled Fund Study 176, “Validation of SHRP Asphalt Mixture Specifications Using Accelerated Testing,” examined the effects of VMA, fine aggregate angularity (FAA), and gradation on the performance (primarily rutting) of HMA. Finally NCHRP Project 4-30, “Test Methods for Characterizing Aggregate Shape, Texture, and Angularity,” was recently awarded. It is expected that this study will provide new methods to more accurately measure the aforementioned properties with improved precision.

Evaluation of aggregate properties has been included in some field and accelerated performance studies. The LTPP Program documents the construction and tracks the performance of numerous HMA pavements. Some of the HMA pavements in the Specific Pavement Studies (SPS) were designed with the Superpave methodology. The SPS-1, -5, and, particularly, -9 sections provide limited data relating aggregate properties to performance. Three test tracks—the MnRoad, WesTrack, and the NCAT Test Track—include Superpave-designed HMA. The NCAT Test Track has a number of different aggregate sources and gradations represented by the test sections. Accelerated testing related to aggregate properties has also been conducted by the FHWA’s Accelerated Loading Facility (ALF) and the Indiana Department of Transportation (DOT)—Purdue University APT Facility.

Based upon performance histories of locally available materials or research projects conducted to address concerns relating to the aggregate specifications included in AASHTO M323, numerous agencies have modified their aggregate specifications for Superpave-designed HMA. Often times this experience is not shared with other agencies that are using similar materials. A consensus among the states, based on their experiences, may indicate the need to alter aggregate test procedures or specifications on a national basis.

1.2 OBJECTIVE

The objective of this study (NCHRP Project 9-35) was to review the technical literature and ongoing research to identify the consensus, source, or other aggregate properties that significantly impact HMA performance. The review also examined the effect of production and crushing operations on aggregate properties. The review concentrated on the effect of aggregate properties on HMA designed using the Superpave methodology, HMA construction, and HMA perfor-

mance. New innovations in aggregate testing were also examined, especially those related to aggregate shape, angularity, and texture.

1.3 SCOPE

To accomplish the research objectives, five tasks were conducted; their descriptions are as follows:

- *Task 1—State of the Practice:* In Task 1, a literature search and review was conducted to determine the current state of the practice on the evaluation and validation of the Superpave aggregate criteria and the state of the art on the development of promising new methods of aggregate characterization. The results from Task 1 are presented in Chapter 2. The influence of aggregate crushing operations is also discussed in Chapter 2.
- *Task 2—Survey of Ongoing Research:* In Task 2, a survey was conducted to identify the preliminary findings of ongoing research related to aggregate properties. The results from Task 2 are presented in Chapter 2 in conjunction with the results from the literature review.
- *Task 3—Survey of Agency Specifications:* A survey was conducted of state aggregate specifications for aggregate used in the production of HMA. The survey provides insights into the widespread adoption of the Superpave method and into the aggregate tests that agencies question. The survey results are summarized in Chapter 3; see also the Appendix.
- *Task 4—Review Performance Data from Field Test Sections and Full-Scale Accelerated Testing:* Results from field test sections and accelerated test sites were reviewed to gather performance relationships for aggregate properties. As expected, there are complex interactions when aggregate properties are altered. These interactions tend to dilute any correlations that may exist; however, trends were identified. The results from the performance review are summarized in Chapter 4. Specific experiments are also discussed in relationship to specific test methods in Chapter 2.
- *Task 5—Final Report:* The final report was prepared to document all of the research conducted in Tasks 1 through 4. Chapters 5 and 6 present (1) future work suggested for validating new aggregate shape and texture parameters based on image analysis and evaluation of the CAR test and (2) a summary of the conclusions of NCHRP Project 9-35.

CHAPTER 2

STATE OF PRACTICE

2.1 INTRODUCTION

The Superpave mix design method, a product of SHRP, was introduced in 1994 (1). The Superpave method included binder, aggregate, and mixture specifications. Many of these specifications used new test methods. One goal of the Superpave method was to provide uniform test methods and specifications to be used across the United States.

Aggregates were addressed through gradation, consensus aggregate properties, and source aggregate properties. Definitions were provided for NMAS and maximum aggregate size. A limited number of gradation control points were established for each NMAS. A restricted zone was recommended along the maximum density line to prevent the use of large quantities of natural sand and to help ensure adequate VMA. Four consensus aggregate properties were specified: coarse aggregate angularity, flat and elongated particles, uncompacted voids content in fine aggregate, and sand equivalent. Specification levels for the consensus property tests depend on design traffic level and depth in the pavement structure (for tests related to permanent deformation). Specifications for consensus aggregate properties are based on the blend of materials used in a given HMA mix and not on individual aggregates. The consensus aggregate properties were to be uniformly implemented across the United States regardless of local geology. Source aggregate properties include LA abrasion, soundness, and deleterious materials. It was felt that these properties would need to be adjusted depending on the local geology; therefore, agencies were to set the specification levels for source aggregate properties for Superpave-designed mixes.

There has been controversy regarding some of the consensus aggregate property tests and specification levels. All four tests are empirical in nature, and there is very little data available to support the establishment of specification requirements. Their relationship to performance has been questioned. In some cases, the implementation of the consensus aggregate properties and Superpave gradation bands have prevented the use of materials or mixes that have been historically used to provide good-performing mixes. This has led to research relating the consensus aggregate properties and aggregate gradations to the performance of HMA and to efforts to develop or use alternative tests. A discussion of research related to each of the Superpave aggregate tests, Superpave gradation

bands, and alternatives follows. Since the aggregate crushing process affects the resulting shape and texture of the aggregate particles, a brief discussion on crushing is also included.

2.2 COARSE AGGREGATE ANGULARITY

2.2.1 Background

Prior to the development of Superpave, several studies indicated increased resistance to permanent deformation with increasing fractured faces in coarse aggregate (4–12). The fourth questionnaire used in the Delphi process to identify the consensus aggregate properties ranked coarse aggregate angularity second to gradation limits in terms of importance (1). However, no test method was identified. FHWA's Office of Technology Applications recommended Pennsylvania DOT Test Method 621 (13). ASTM D5821 was based on the Pennsylvania test method and was later adopted as the method for measuring coarse aggregate angularity within the Superpave mix design method (14, 15).

The fractured face count of a representative sample of coarse aggregate is determined by visual inspection. ASTM D5821 (16) defines a fractured face as “an angular, rough, or broken surface of an aggregate particle created by crushing, by other artificial means or by nature.” A fractured face is only counted if its area is greater than 25% of the largest projection (cross-sectional area) of the particle. A fractured particle is “a particle of aggregate having at least the minimum number of fractured faces specified (usually one or two)” (16).

To run the test, a representative sample is washed over the 4.75-mm sieve and dried to a constant mass. The size of the sample is dependent on the nominal maximum aggregate size of the aggregate. The aggregate particles are visually inspected and divided into piles of particles with no fractured faces and one or more fractured faces. Prior to 2001 when the ASTM D5821 was revised, the separation included a questionable pile for particles where the tester was uncertain whether a fractured face met the definitions (14). The questionable pile was eliminated from the ASTM standard in 2001 (16); however, the use of a questionable pile is still included in a provisional AASHTO Standard TP-61 (15). After all of the particles are sorted, the mass of each pile is determined. The percent fractured particles are expressed as the mass of particles having a given number of fractured faces divided by

the total mass of the samples (result expressed as a percentage). For Superpave specifications, after the percent of particles with one or more fractured faces is determined, the aggregates are re-examined for two or more fractured faces.

2.2.2 Relationship Between Percent Coarse Aggregate Fractured Faces and Performance

Cross and Brown (17) reported on the selection of aggregate properties to minimize rutting. The study was based on testing conducted on 42 pavements in 14 states; 30 of the 42 pavements had experienced premature rutting. Rut-depth measurements and cores were taken at each site. The cores were tested for density, asphalt content, and gradation. The percent with two crushed faces was determined separately for the material retained on the 4.75-mm sieve and the material passing the 4.75-mm sieve and retained on the 0.600-mm sieve. The uncompacted void content was determined according to the National Stone Association flow test, Method A (the basis for AASHTO T304). Some of the cores were recompact using the U.S. Army Corps of Engineers (USACE) gyratory compactor or Marshall hammer method (75-blow). The measured rut depth at each site was converted to a rutting rate by dividing the rut depth by the square root of accumulated equivalent single axle loads (ESALs).

Data analysis indicated that none of the aggregate properties were related to the rutting rate when all of the data were included. The authors felt that when air voids were less than 2.5%, rutting is likely to occur regardless of the other mix properties. Using the data from pavements with in-place air voids greater than 2.5%, a relationship shown in Equation 1 (17) between the percent with two crushed faces in the coarse aggregate and the rutting rate was developed. The relationship produces an $R^2 = 0.42$. Analysis of variance indicated the relationship was significant ($\alpha = 0.01$).

$$\text{Rut Depth (mm)} \div \sqrt{\text{ESAL}} = 0.03138 - 0.0025 \times (\text{Percent 2 Crushed Faces}) \quad (1)$$

Kandhal and Parker evaluated the properties of nine coarse aggregate sources (2). Nine tests were performed to evaluate coarse aggregate shape, angularity, and texture including the following:

- Index of Aggregate Particle Shape and Texture (ASTM D3398),
- Image Analysis (Georgia Institute of Technology),
- Flat and Elongated and Flat or Elongated Particles by ASTM D4791,
- Flakiness Index (British Standard 812),
- Elongation Index (British Standard 812),
- Percent of Fractured Particles in Coarse Aggregate (ASTM D5821),

- Uncompacted Voids in Coarse Aggregate (Currently AASHTO TP56), and
- Uncompacted Voids in Coarse Aggregate—Shovel Techniques (AASHTO T19).

ASTM D5821 was only performed on the three gravel sources included in the nine sources. Because of the limited data collected, ASTM D5821 was excluded from correlation matrices with other test methods and the rutting performance of mixes produced with each of the coarse aggregate sources.

Rut testing was performed on the nine mixtures using the Superpave Shear Tester and Georgia Loaded Wheel Tester (GLWT). The uncompacted voids in coarse aggregate test (AASHTO TP56) produced the best relationships with the rutting parameters from all nine mixtures and a reduced data set that had unusual mix properties (2). The results from AASHTO TP56 and ASTM D3398 were highly correlated. The authors recommended uncompacted voids in coarse aggregate (AASHTO TP56) and flat or elongated particles on the 2:1 ratio to characterize coarse aggregate shape, angularity, and texture.

Hand et al. (13) conducted round-robin testing to determine the precision of ASTM D5821. The study was initiated because of concerns that insufficient fractured faces in the original crushed gravel source used at WesTrack may have contributed to the premature failure of the coarse-graded sections. The materials were collected from cold feed samples taken during the construction and reconstruction of WesTrack. Four materials were included in the study based on the coarse aggregate fractions of (1) coarse blends of Dayton crushed gravel produced in 1994 and placed in the tangents; (2) fine blends of Dayton crushed gravel produced in 1994 and placed in the tangents; (3) coarse blends of Dayton crushed gravel produced in 1995 and placed in the curve sections; and (4) the crushed andesite from Lockwood, Nevada, used in the coarse-graded replacement sections. The percent fractured faces of the fine and coarse mixtures placed on the tangent sections were found to be equal. The actual values (98% one fractured face and 96% two or more fractured faces) exceeded the Superpave requirements for 10 to 30 million design ESALs. The study concluded, “CAA [coarse aggregate angularity] did not have an effect on the rutting performance of Superpave mixtures at WesTrack” (13).

A Canadian study was conducted in Saskatchewan to investigate the effect of the percent fractured coarse aggregate particles on rutting performance (18). The majority of Saskatchewan’s coarse aggregate comes from glacial gravel deposits. Aggregates with high fractured face counts are more expensive. Ten pavements ranging in age from 2 to 9 years were evaluated. Rut depths were measured and cores were recovered within and between the wheel paths. Cores were tested for density, voids filled, asphalt content, coarse aggregate fractured face count, and uncompacted void content in fine aggregate. The fractured face count was determined according to Saskatchewan Standard Test Procedure 204-4. The

fractured face counts ranged from 54% to 93.7%. It was not reported whether the fractured face count represents one or two fractured faces. A stepwise regression was performed to identify the factors most related to the in-place rut depth. The regression identified traffic (accumulated ESALs), between wheel path asphalt content, between wheel path voids filled, and between wheel path density ($R^2 = 76.6$) (18). The rut depths and accumulated ESALs provided in the paper were converted to a rutting rate as recommended by Cross and Brown (17). Regression analysis between the reported fractured face counts and rutting rate indicated no relationship. Overall, the rutting rates were higher than those reported by Cross and Brown.

2.2.3 Precision of ASTM D5821

ASTM D5821 for fractured face count of coarse aggregate reports a multilaboratory standard deviation of 5.2% for well-trained observers (16). Thus, the acceptable range between two properly conducted tests by two well-trained observers would be 14.7%. This precision is based on an Ontario Ministry of Transportation study that included 34 observers' evaluations of two samples of partially crushed gravel. Hand et al. (13) reported the precision statement shown in Table 1 based on 10 laboratories' tests of four aggregates used at WesTrack.

2.2.4 Alternative Methods of Measuring Coarse Aggregate Angularity

Alternative methods to ASTM D5821 have been investigated that combine shape, angularity, and texture into one measure (2, 19–21). Two alternatives that have received attention are ASTM D3398, "Index of Aggregate Particle Shape and Texture," and AASHTO TP56, "Uncompacted Voids in Coarse Aggregate." The literature indicates that angular, rough-textured aggregates have a particle index value greater than 14, whereas rounded and/or smooth aggregates have a particle index value less than 12 (19). Ahlrich (19) developed the uncompacted voids in coarse aggregate test based on ASTM C1252, "Uncompacted Void Content in Fine Aggre-

gate." The two tests are highly correlated, producing an $R^2 = 0.94$ (2, 19). AASHTO TP56 is preferable to ASTM D3398 because of the significant time required to perform ASTM D3398. One drawback to both tests is that the effects of particle shape, angularity, and texture cannot be separated.

Kandhal et al. (20) indicated that the particle shape and angularity index obtained from ASTM D3398 increase sharply as the percentage of two fractured faces from ASTM D5821 increases above 80%. However, the authors note (20):

Theoretically, 100% crushed particles would be preferable to use when employing gravel coarse aggregates in an HMA mix. However, the benefits that might be achieved by requiring the 2-face crushed count to be 100% should be weighed against the additional cost involved in the crushing operation.

Ahlrich (19) investigated 11 aggregate blends meeting the Federal Aviation Administration's P401 gradation. The blends were produced by combining different percentages of crushed limestone, crushed gravel, uncrushed gravel, and natural sand. The blends were combined to produce 0%, 30%, 50%, 70%, and 100% crushed coarse aggregate particle counts. Optimum asphalt content was determined for each blend using the USACE Gyrotory Testing Machine. The resulting mixtures were tested for rutting resistance using a confined repeated-load permanent deformation test.

Coarse aggregate shape, angularity and texture were evaluated using the USACE test for fractured face count (CRD-C 171), ASTM D3398, and the uncompacted voids in coarse aggregate test (AASHTO TP56). Testing indicated a strong correlation ($R^2 = 0.98$) between the uncompacted voids content of the as-received material and the fractured face count. Table 2 shows the correlations between individual tests and three parameters from the confined repeated-load permanent deformation test. The combined (coarse and fine aggregate) particle index value (PI Composite) from ASTM D3398 appears to provide the best overall correlation. The particle index value on the coarse material also provides good correlations. The percent crushed face count (PCP Composite) as measured by CRD-C 171 for the composite coarse and fine aggregate as well as the uncompacted voids in coarse aggregate are also good predictors.

TABLE 1 Precision statement for both one or more and two or more fractured faces (13)

Property and Index Type	Standard Deviation, %	Acceptable Range of Two Results
<i>One or More Fractured Faces</i>		
Single-Operator Precision	1.1	3.0
Multilaboratory Precision	1.8	5.1
<i>Two or More Fractured Faces</i>		
Single-Operator Precision	1.8	5.1
Multilaboratory Precision	2.9	8.2

TABLE 2 Rankings for correlations between aggregate characterization tests and permanent deformation results (19)

Rank	Permanent Strain (R^2)	Creep Modulus (R^2)	Slope of Deformation Curve (R^2)
1	PCP Composite (0.87)	PI Composite (0.73)	PI Composite (0.71)
2	PI Composite (0.78)	PI Coarse (0.69)	PCP Composite (0.65)
3	PI Coarse, (0.68)	PCP Composite (0.63)	PI Coarse (0.52)
4	UV Coarse (0.65)	UV Coarse (0.56)	UV Coarse (0.43)
5	PCP Coarse (0.60)	PCP Coarse (0.46)	ASTM C1252 Method A (0.41)

Note: PCP = percent crushed particles (CRD-C 171)
 PI = Particle Index Value (ASTM D3398)
 UV = uncompacted voids in coarse aggregate (AASHTO TP 56)
 Composite = both coarse and fine aggregate

As described previously for the aggregates studied as part of NCHRP Project 4-19, Kandhal and Parker (2) identified AASHTO TP56, “Uncompacted Void Content in Coarse Aggregate,” as being the test most related to the rutting performance of a coarse-graded mix produced using nine different coarse aggregate sources and a single natural sand source.

Hossain et al. (21) studied the results from ASTM D3398, “Index of Aggregate Particle Shape and Texture,” and the uncompacted voids in coarse aggregate to measure coarse aggregate angularity. The effects of gradation and the percentage of flat and elongated particles were considered on the test results. Two standard gradations were developed for the uncompacted voids test. The gradations were based on the maximum density line for gradations with maximum particle sizes of 12.5 or 19.0 mm. The particle index value and uncompacted voids tests were run on both the individual size fractions and the proposed blended gradations. Testing indicated a good relationship between the calculated index using the results from the individual size fractions and the measured values from blended samples representing the two standard gradations. The authors recommended the use of a standard gradation for relative comparison of coarse aggregate sources (21). The standard gradations established by Hossain et al. (21) were adopted by AASHTO TP56. For comparing gradations, the authors recommended testing the individual size fraction and then calculating the result for a target gradation.

Flat and elongated particles tend to increase the measured uncompacted voids content and aggregate particle index. However, flat and elongated particles are not desirable in HMA (21). Relationships between percent flat and elongated particles and both uncompacted voids and particle index were obtained for the limited materials used in the study. The relationships were non-linear and were different for gravel and crushed stone (based on the differences in angularity and texture between the two groups) (21, 22). The relationships were developed for both the 3:1 and 5:1 ratios for flat and elongated particles.

Hossain et al. (22) evaluated the rutting performance of 11 mixes produced with blends from four crushed gravel sources, a limestone source, a granite source, and a natural sand. Alabama DOT 416 Mix 4 specifications were used to estab-

lish a single gradation for all of the mixes. The gradation is a 12.5-mm NMAS mixture that approximately follows the Superpave maximum density line. Rut testing was performed with the GLWT and a confined repeated-load permanent deformation test. No single aggregate test provided a strong relationship with the performance of all the mixes. The highest correlation coefficient ($R = -0.70$) was for percent flat or elongated particles by particle count at the 5:1 ratio.

Ongoing research by Rismantojo (23) as part of NCHRP Project 4-19(2) evaluated five coarse aggregates using accelerated loading. The aggregates included a dolomite, limestone, natural gravel, granite, and traprock. Coarse aggregate tests performed as part of the study include

- Flat and Elongated Particles (ASTM D4791) at the 2:1, 3:1, and 5:1 ratio;
- Uncompacted Voids in Coarse Aggregate (AASHTO TP56) Method A (standard grading) and Method B (individual size fractions);
- Micro-Deval (AASHTO TP58);
- Magnesium Sulfate Soundness (AASHTO T104);
- LA abrasion (ASTM C96 Type C);
- Bulk Specific Gravity (ASTM C127); and
- Water Absorption (ASTM C127).

A correlation matrix was developed among the aggregate tests. Several strong relationships were indicated between the various forms of ASTM D4791 used in the study. A fair relationship ($R = 0.786$, p -value = 0.064) was indicated between flat or elongated particles and uncompacted voids in coarse aggregate Method A. Figure 1 presents the combined data from NCHRP Projects 4-19 and 4-19(2). The regression line in the figure excludes the slag and sandstone sources tested as part of NCHRP Project 4-19 as outliers. Regression analysis for the combined data (including the outliers) produces an $R^2 = 0.24$. The relationship is not significant at the 5% level with a p -value = 0.06. This indicates that although particle shape has a strong influence on uncompacted voids results, texture—such as that found on the slag and sandstone—can also have a strong effect. Rutting models developed by Kandhal and Parker (2) indicated that high percentages of flat

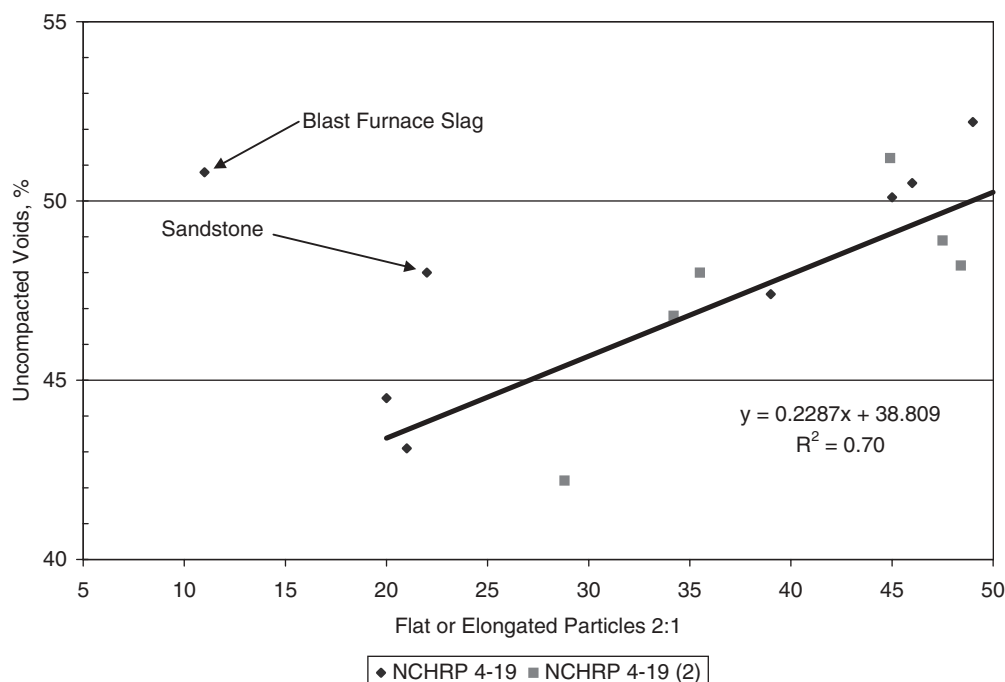

Figure 1. Relationship between flat or elongated particles and uncompacted voids (2, 22).

or elongated particles at the 2:1 or 5:1 ratio were undesirable. Rismantojo (23) notes that Kandhal and Parker's (2) conclusion that high percentages of flat or elongated particles are undesirable from a rutting stand point is unrealistic based on the relationship with uncompacted voids in coarse aggregates. Higher percentages of flat or elongated particles tend to produce higher uncompacted voids and higher uncompacted voids tend to produce mixtures with less rutting.

Rismantojo (23) performed correlations between coarse aggregate properties and both mix volumetric properties and rutting performance. Flat or elongated particles at the 2:1 ratio were positively correlated with optimum asphalt content. This indicates that for the aggregates tested, higher asphalt contents resulted for mixes with higher percentages of flat or elongated particles. Thus, mixes containing flat and elongated particles may be more durable. Flat and elongated particles at the 3:1 ratio were negatively correlated with the density at N_{initial} . As the percentage of flat and elongated particles at the 3:1 ratio increased, the density at N_{initial} decreased. Thus, flat and elongated particles also make it easier to meet the N_{initial} requirements. VMA was correlated positively with the uncompacted voids in coarse aggregate for both Methods A and B. Overall, Method B, which is the average of the uncompacted voids for three individual size fractions, produced better correlations.

Full-scale rutting tests were performed at the Indiana DOT APT Facility in West Lafayette, Indiana. Five mixes were tested in the APT facility. The rounded gravel mix produced 29.5 mm of rutting after 5,000 passes, at which time testing was terminated. The other four sections containing quarried

stone were tested to 20,000 passes. A strong relationship was identified between the uncompacted voids from both Methods A and B and the total rut depth at 5,000 passes ($R = -0.947$ and $R = -0.983$, respectively). This relationship is strongly influenced by the uncrushed gravel mixture. When the gravel mix is excluded and only the four mixes that were tested to 20,000 passes are analyzed, the uncompacted voids in the coarse aggregate (Method A) performed on the plant stockpile material produces the best correlation with $R = -0.758$ (23). The relationship is not significant at the 5% level.

2.2.5 Summary of Research Related to Coarse Aggregate Angularity

Numerous research studies have indicated improved rut resistance with increased percentages of fractured faces in coarse aggregate. However, the current test method, ASTM D5791, is subjective, requiring the technician to visually determine the presence and number of fractured faces. The Superpave fractured face count specifications are based on the consensus of an expert panel and not on laboratory test results. Research completed since the implementation of the Superpave method has focused on alternative tests that are more quantitative and objective.

Several studies have evaluated the relationship between both the particle index value (ASTM D3398) and the coarse aggregate uncompacted voids test (AASHTO TP56) and rutting performance. Trends indicate that higher particle index values or uncompacted voids contents produce more rut-resistant pavements. Relationships have been identified between both tests

and flat and/or elongated particles. Increasing values of flat and/or elongated particles at 2:1 or 3:1 ratios tend to increase the particle index value and uncompacted voids. This indicates that the tests are highly influenced by particle shape. The uncompacted voids test is also sensitive to the texture of coarse aggregate particles. Both of these tests combine the effects of shape, angularity, and texture. Digital imaging methods are being developed that can separately quantify these parameters. These will be discussed later in the report.

2.3 FLAT AND ELONGATED PARTICLES

2.3.1 Background

The asphalt industry believes excessive flat and elongated particles (F&E) to be undesirable. Perfectly cubical aggregates may also be undesirable. Prior to the implementation of the Superpave method, several design procedures had specifications limiting the percent of F&E allowed in the mix. AASHTO M283 allowed no more than 15% combined F&E as tested in accordance with ASTM D4791. Roberts et al. (24) state: "Flat and elongated particles impede compaction and thus may prevent the development of satisfactory strength in HMA." *The Aggregate Handbook* (25) states: "Specifications requiring particle-by-particle measurements vary widely in terms of limiting values and allowable percentages of defective particles. Research has largely been unsuccessful in establishing criteria related to performance." It is generally believed that high percentages of F&E were undesirable because they hinder compaction and, if broken under the roller, expose uncoated aggregate surfaces.

The fourth questionnaire used in the Delphi process by SHRP to identify the consensus aggregate properties ranked thin, elongated pieces eighth in terms of importance (1). ASTM D4791, "Standard Test Method for Flat Particles, Elongated Particles, or Flat and Elongated Particles in Coarse Aggregate," was recommended as the test method for thin, elongated particles by the expert panel. USACE (26) originally developed the method.

When the Superpave method was first implemented, ASTM specified that the test be performed on the +9.5-mm material by size fraction (14). The Superpave method specified that the test be run on the +4.75-mm material (1). ASTM later revised the standard to include the +4.75-mm material (16). The test is run by first performing a gradation on a representative sample of the coarse aggregate. One hundred particles are split out for testing for each size fraction that has at least 10% retained. The Superpave method specifies that the particle is considered flat and elongated if the particle's maximum dimension is five or more times the particle's minimum dimension. The maximum and minimum dimension of each particle is measured or, alternatively, a proportional caliper may be used. If a proportional caliper is used, the largest dimension of the particle is used to set the caliper. If the particle can pass through an opening that is one-fifth of the max-

imum dimension, the particle is considered flat and elongated. The percentage of flat or elongated particles may be reported by weight or by particle count. The overall percent of F&E is based on a weighted average determined from the sample gradation and the flat and elongated percentages for each size fraction.

The Superpave method allows no more than 10% F&E exceeding the 5:1 ratio for the combined aggregate blend used in asphalt mixtures for pavements with >1 million ESALs in the design life (15, 27). The Superpave specifications are based on the blend of coarse aggregate used in the HMA, not on an individual stockpile. The Stone Matrix Asphalt Technical Working Group guide specification allows 5% 5:1 and 20% 3:1 F&E (15, 28).

2.3.2 Relationship Between F&E and Performance

A limited number of studies were completed to relate the effect of F&E on performance prior to SHRP (29–33). Huber et al. (34) evaluated the effect of F&E on the volumetric properties of two Superpave 19.0 NMAS mixes. The coarse aggregate was a crushed No. 57 stone produced from a limestone source. Coarse aggregate was produced using both a vertical shaft impact crusher and a cone crusher. Vertical shaft impact crushers tend to produce more cubical aggregate. Neither crusher produced F&E that exceeded the 5:1 ratio. The vertical shaft impact crusher produced 9.0% and the cone crusher produced 19.4% particles exceeding the 3:1 ratio. HMA was produced with aggregate from both crushers to meet each of the two gradations for a total of four mixes. Two laboratories tested each mix at constant asphalt content in the Superpave gyratory compactor. Based on the sample density results, the authors concluded that F&E exceeding the 3:1 ratio do not negatively impact volumetric properties (34); however, this was a very limited study from which to make general conclusions about the effect of F&E on mixture volumetric properties.

Brown et al. (35) evaluated the effect of five levels of F&E on the volumetric properties, aggregate breakdown, and moisture susceptibility of stone matrix asphalt (SMA). An Arkansas limestone source was crushed to provide two different levels of F&E. The F&E varied from 67 to 38 for the 2:1 ratio, 25 to 3 for the 3:1 ratio, and 1 to 0 for the 5:1 ratio. SMA was produced with both coarse aggregates and 75/25, 50/50, and 25/75% blends of the two aggregates. There was a slight trend of increasing VMA with increasing percentages of F&E. The VMA increased 1.2% from the cubical to the more F&E coarse aggregate. Gradation testing indicated a statistically significant increase in aggregate breakdown on the 4.75-mm sieve for higher levels of F&E. Breakdown increased by approximately 4% between the two extremes in particle shape for samples compacted with 50 blows of each face with a Marshall hammer (35).

Vavrik et al. (36) evaluated the effect of F&E on the volumetric properties and aggregate breakdown for gyratory-compacted samples. Aggregate was obtained from a dolomite and a gravel source. The coarse aggregate particles for each source were sorted into particles whose maximum-to-minimum dimension was less than the 3:1 ratio, greater than the 3:1 ratio but less than the 5:1 ratio, and greater than the 5:1 ratio. A modified Superpave mixture design was developed using the cubical (less than 3:1 ratio) coarse aggregate from each source. The same manufactured sand, natural sand, and mineral filler were used for both designs. The dolomite mixture used 55% coarse aggregate with the fine aggregate being an 80% to 20% blend of manufactured and natural sand. The gravel mixture used 52% coarse aggregate with a 70% to 30% split of manufactured to natural sand for the fine fraction. The design asphalt contents were chosen using the locking point concept. The locking point is defined as the first occurrence of three gyrations at the same height preceded by two gyrations at the same height. The locking point is the number of gyrations at which the first of the three consecutive gyrations of the same height occur. The average locking point for the cubical dolomite mixture was 101 gyrations, and the average locking point for the cubical gravel mixture was 90 gyrations.

Four samples were then compacted at the optimum asphalt content determined for the cubical coarse aggregate of each of the aggregate sources at each of four blends of F&E. The samples were compacted to the 110 gyrations. The volumetric results are summarized in Table 3. The data indicate a trend of increasing VMA with increasing F&E as indicated

by the previous studies. Vavrik et al. (36) evaluated aggregate breakdown during gyratory compaction and noted that for the dolomite mixture, the percent passing the No. 4 sieve (4.75-mm) increased by 3% to 5% and that the percent passing the No. 8 (2.36-mm) sieve increased by 1% to 4% for the non-cubical blends as compared with the cubical blends. Similarly, the percent passing the No. 4 sieve (4.75-mm) increased by 2% to 4% for the gravel mixtures. No corresponding increase was observed for the percent passing the No. 8 sieve for the gravel mixtures. The authors concluded that increased F&E resulted in increased aggregate breakdown and that the changes in the volumetric properties (including VMA) resulted from the changes in gradation caused by aggregate breakdown (36).

Buchanan (37) evaluated the effect of six levels of F&E from two aggregate sources on the volumetric properties, rutting performance, and fatigue performance of a 12.5-mm NMAS Superpave mix design. The six levels of F&E consisted of the as-received aggregate from a limestone and a granite source as well as each of those aggregates crushed at two different rotor speeds in a scale vertical shaft impact crusher. The blend percents of F&E, volumetric properties, and rut depths are shown in Table 4.

Some of the F&E results for the limestone aggregate appear anomalous. Higher rotor tip speeds should produce more cubical particles because the aggregate is thrown with more energy against cascading aggregate in the crusher. This is consistent with the data shown in Table 4 except for the limestone sample at 65 m/s.

Based on Table 4, the volumetric properties for the limestone aggregate match the findings of Huber et al. (34) with

TABLE 3 Volumetric data for various levels of F&E for Illinois study (36)

Material	Air Voids, %	VMA, %	Locking Point
<i>Dolomite Coarse Aggregate</i>			
Cubical	3.75	14.7	101
50-50-0 ¹	4.24	15.1	97
30-50-20	4.48	15.4	102
70-0-30	4.16	15.1	101
<i>Gravel Coarse Aggregate</i>			
Cubical	3.55	14.6	93
50-50-0 ¹	4.37	15.3	113
30-50-20	4.61	15.6	120
70-0-30	4.62	15.6	119

¹ 50-50-0 are the percentages of cubical particles with shape ratios (maximum-to-minimum dimensions) >3:1 but less than 5:1 and particles with shape ratios >5:1.

TABLE 4 F&E levels and resulting mixture properties (37)

Aggregate Type	F & E Ratios			Optimum AC%	VMA, %	APA Rut Depth (Dry), mm
	2:1	3:1	5:1			
Limestone As-Received	69.2	29.5	3.8	4.2	13.7	5.9
Limestone @ 55 m/s ¹	58.6	21.8	0.2	4.5	13.9	6.6
Limestone @ 65 m/s	72.0	16.2	3.7	4.2	13.7	6.2
Granite As-Received	85.4	57.0	23.0	5.0	14.2	9.2
Granite @ 45 m/s	42.9	14.4	0.4	4.6	13.4	6.2
Granite @ 68 m/s	35.1	2.1	0.1	4.5	13.4	6.1

¹ Indicates the rotor tip speed on the vertical shaft impact crusher.

little change over a moderate range of 3:1 particles. The granite aggregate indicates decreasing VMA with decreasing F&E as noted by Brown et al. (35) and Vavrik et al. (36). Rut testing was performed in the Asphalt Pavement Analyzer (APA) at 64°C with a 100-lb vertical load and 100 psi hose pressure. There was not a statistically significant difference between the APA rut depths for the limestone mixtures. The rut depths for the granite mixtures produced in the vertical shaft impact crusher were significantly less than the rut depth for the as-received mixture; however, the granite mixes produced using the aggregate from the vertical impact crusher have failing VMA values and therefore lower asphalt contents. Constant strain fatigue tests were performed according to AASHTO T321 at two strain levels. There was not a statistically significant difference in the fatigue results for either aggregate at the three levels of F&E evaluated (37); therefore, there does not appear to be an effect of F&E on a mixture fatigue resistance.

Oduroh et al. (38) evaluated the effect of three levels of F&E on compacted sample density, shear stiffness, and tensile properties. The goal of the study was to provide data to states that are considering the 3:1 ratio in lieu of the 5:1 ratio as the definition of F&E. The three levels of F&E investigated were 0%, 15%, and 40% particles exceeding the 3:1 ratio for maximum-to-minimum particle dimension. A single Kentucky limestone coarse aggregate and Ohio River natural sand were used to produce a 12.5-mm NMA mixture. The samples were mixed with an unmodified performance grade (PG) 64-22 at an optimum asphalt content determined using $N_{design} = 96$.

Performance tests were performed with the Superpave Shear Tester (SST) and Indirect Tensile Tester (IDT) on samples prepared at optimum asphalt content with 0%, 15%, and 40% F&E. Testing included frequency sweep at constant height, simple shear at constant height, repeated shear at constant height, and IDT tests. Based on the results of the testing, adding 15% or 40% particles exceeding the 3:1 ratio did not affect the compacted mixture density, shear stiffness, or

tensile properties. Repeated shear at constant height testing indicated that the rutting susceptibility of the mixtures with three levels of F&E appeared to be similar at 58°C (38).

Aho et al. (39) evaluated the relationship between the percentages of F&E and aggregate breakdown during construction. Samples of six surface mixtures, representing a range of F&E contents, were sampled at the plant; the mixtures were sampled behind the paver prior to compaction and in-place after compaction. The samples taken after compaction were taken 2 ft (0.6 m) from the corresponding sample taken behind the paver (assumed to be longitudinally). Aggregate samples were collected from both the quarry and the asphalt plant stockpiles for F&E and LA abrasion testing. The percentages of particles exceeding the 3:1 ratio ranged from 8.1% to 54.1% and the percentages of particles exceeding the 5:1 ratio ranged from 0.4% to 21.1% based on the average of eight tests. In addition, for three of the five aggregates, gyratory samples were prepared to simulate aggregate breakdown during mix design. Three samples each were compacted to 4% and 7% air voids.

Statistical analyses were performed to compare the percent passing the No. 4 (4.75-mm) sieve from extracted samples. Comparisons were made between the plant sample and the sample taken behind the paver prior to compaction and between the sample taken behind the paver prior to compaction and the sample taken after compaction. Statistical differences were observed before and after compaction for two mixtures produced with dolomite aggregates and between the plant and paver sample for one of the mixtures. The LA abrasion values of the two dolomite sources were 25% and 26%. Breakdown was not observed when comparing samples taken before and after compaction for the remaining three mixtures even though one mixture had 54.1% and 21.1% F&E, based on the 3:1 and 5:1 ratios, respectively (39). A relationship was observed between lift thickness and breakdown.

The recovered samples from each sampling location were also tested for F&E. As shown in Figure 2, testing indicated

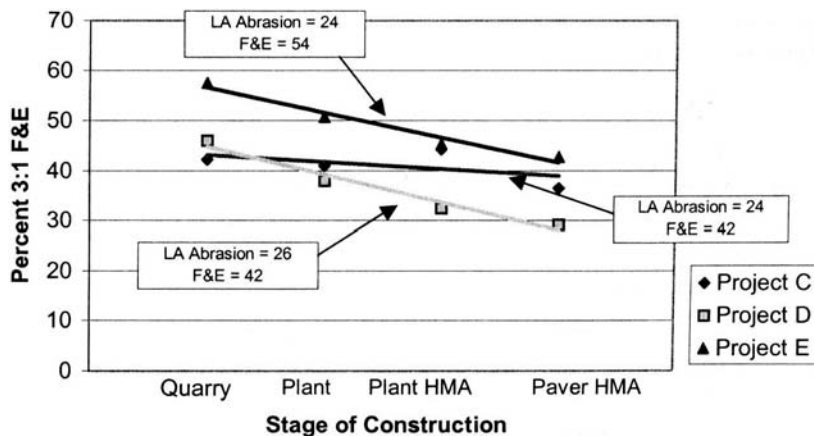

Figure 2. Interaction among F&E, LA abrasion, and aggregate breakdown (39).

that for the mixtures that contained in excess of 30% particles exceeding the 3:1 ratio, the percent F&E *decreased* from the quarry to the plant stockpile, from the plant stockpile to the plant mix, and from the plant mix to the sample taken behind the paver. None of the five projects indicated a significant difference between the percent of F&E measured on samples recovered behind the paver to samples recovered after compaction (39).

Comparisons were made between the amount of breakdown that occurred during construction and the amount of breakdown that occurred during gyratory compaction. The data indicated practically no difference between the amount of breakdown that occurred for samples compacted to 4% or 7% air voids. The authors concluded that the amount of breakdown that occurs during gyratory compaction generally exceeds that which occurs during normal construction (39).

Ongoing research as part of NCHRP Project 4-19(2) has examined the effect of F&E on volumetric properties and permanent deformation during accelerated loading. Significant relationships were observed between the percent of flat or elongated or the percent F&E and both LA abrasion loss and uncompacted voids in coarse aggregate, as shown in Table 5. Based on the six aggregates tested in this study, there was no correlation between F&E and VMA; however, the gradations differ slightly between the mixes. A strong positive correlation ($R = 0.993$, p -value = 0.0007) was observed between percent flat or elongated particles at the 2:1 ratio and total binder content. No significant relationships were observed between F&E and the rutting performance of the mixes (23). It should be noted that the percent of F&E only ranged from 11.6% to 28.0% for the 3:1 ratio and 1.8% to 8.1% for the 5:1 ratio.

Additional research on F&E is ongoing at the International Center for Aggregates Research. The study is examining the change in the percentage of F&E during laboratory mixing and compaction, aggregate breakdown during mixing and compaction, volumetric properties, tensile strength, and resistance to rutting (40). In addition to the proportional caliper typically used for ASTM D4791, the study examined the use of the multiple ratio shape analysis device. Using similar gradations, increasing F&E on the 3:1 ratio from cubical to 20%

and 30% of particles exceeding the 3:1 ratio increased the mixture VMA by 1% to 1.5%.

2.3.3 Precision of F&E Tests

ASTM D4791 does not contain a precision statement. Prowell and Weingart (41) conducted a study to determine a precision statement for ASTM D4791. A total of five aggregates were tested in the study, but only three were used for determining a precision statement for ASTM D4791. The aggregates were igneous granite, diabase, and dolomitic limestone with percentages of particles exceeding the 3:1 ratio ranging from 8.2 to 45.8 and percentages of particles exceeding the 5:1 ratio ranging from 0.2% to 12.7%. Fifteen labs participated in the study. Each laboratory tested two replicates (100 particles each) of each of three particle sizes: $-3/4$ in. to $+1/2$ in., $-1/2$ in. to $+3/8$ in., and $-3/8$ in. to +No. 4.

Figure 3 shows the pooled within lab (W/L) and between lab (B/L) standard deviations versus the average percent for the 5:1 particles. From Figure 4, there appears to be a linear relationship between the standard deviation and average level of the test. A similar trend was observed for the 3:1 samples. In cases in which a linear relationship exists between the standard deviation and the mean of the test values, ASTM C802 recommends that one use the coefficient of variation. Figure 3 shows the coefficient of variation versus the average percent particles exceeding the 5:1 ratio. The coefficient of variation sharply decreased with increasing mean test values for the 5:1 ratio until it reaches an asymptotic level. This indicates that the test method (5:1 ratio) is subject to erratic variations. The test is variable, even at low levels of F&E. The coefficient of variation is inflated by dividing the standard deviation by the low (close to zero) mean levels of 5:1 F&E; however, the coefficient of variation for the 3:1 ratio was relatively constant.

The precision statement for ASTM D4791 was written according to ASTM C670 (42). The single-operator coefficient of variation for the 3:1 ratio was found to be 26.1% (41). The difference between two individual test results with a 95% confidence interval is determined by multiplying the standard deviation by $2\sqrt{2}$; therefore, results of two properly

TABLE 5 Significant correlations between different coarse aggregate tests in NCHRP Project 4-19(2) (23)

Tests	Correlation Coefficient, p -value
Flat or Elongated Particles 2:1 and Uncompacted Voids Method A	0.786, 0.064 ¹
Micro-Deval and Magnesium Sulfate Soundness	0.863, 0.027
Flat or Elongated Particles 5:1 and LA Abrasion	0.832, 0.040
Flat and Elongated Particles 5:1 and LA Abrasion	0.844, 0.035
Micro-Deval and Bulk Specific Gravity	-0.877, 0.022
LA Abrasion and Bulk Specific Gravity	-0.812, 0.049
Micro-Deval and Water Absorption	0.961, 0.002
Magnesium Sulfate Soundness and Water Absorption	0.894, 0.016

¹Not significant at the 5% level, significant at the 10% level.

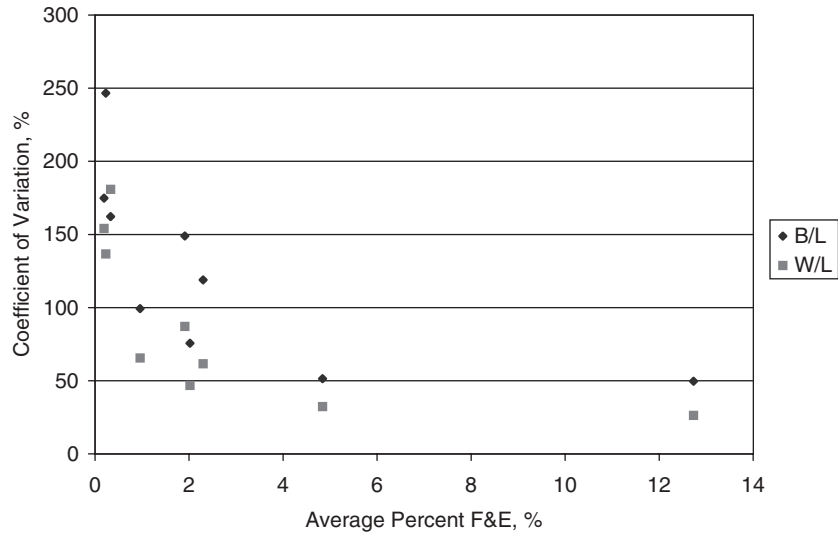

Figure 3. Pooled coefficient of variation for F&E tests versus average for 5:1 ratio (41).

conducted tests by the same operator on the same sample using the same proportional caliper should not differ by more than 73.9% of their average. The multilaboratory coefficient of variation has been found to be 35.3%. Therefore, results of two laboratories on identical samples of an aggregate should not differ by more than 99.9% of their average. For comparison, the single operator and multilaboratory coefficients of variation for the 2:1 ratio are 9.1% and 15.0%, respectively.

A precision statement was not prepared for the 5:1 testing ratio because of the variability in the standard deviation and the coefficient of variation as a function of the mean. The high within- and between-laboratory standard deviations and coefficients of variation call to question the value of using ASTM D4791 for a specification limit unless the 2:1 ratio is used.

The AASHTO Materials Reference Laboratory has also compiled statistics for the precision of flat and elongated aggregate tests performed on proficiency samples No. 117 and 118 (43). The results are shown in Table 6. The results are based on testing at the 5:1 ratio. Similar to the research by Prowell and Weingart (41), the results indicate the tremendous variability of the test method.

2.3.4 Summary of Research Related to F&E

A limited number of studies have been conducted to relate the percentage of F&E to performance since the implementation of the Superpave method. None of the studies have addressed the relationship between F&E and performance

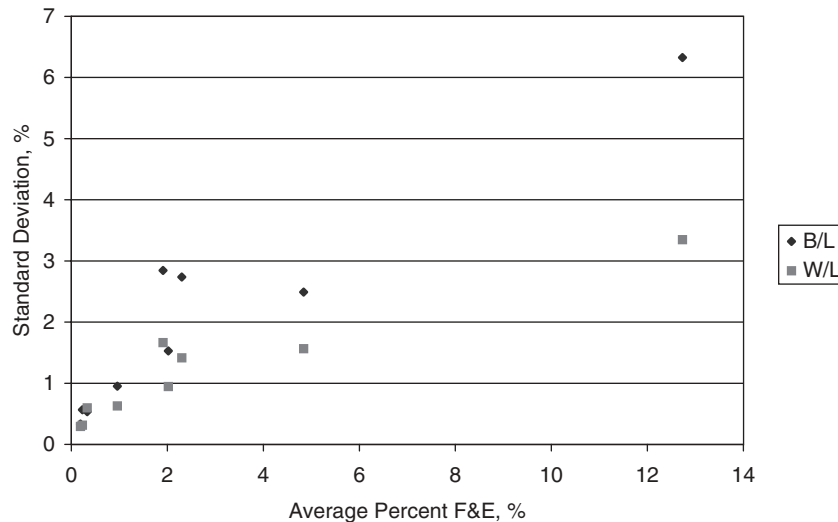

TABLE 6 Precision of ASTM D4791 F&E tests from AMRL Proficiency Samples 117 and 118 (43)

Particle Size, mm	Number of Labs	Sample 1 Multilaboratory Precision			Sample 2 Multilaboratory Precision			Single Operator Precision			
								Sample 1		Sample 2	
		Avg.	1S%	D2S%	Avg.	1S%	D2S%	1S%	D2S%	1S%	D2S%
19.0 to 12.5	128	14.4	51.0	144.3	13.1	53.4	151.0	26.6	75.3	29.1	82.2
12.5 to 9.5	123	17.6	43.9	124.1	17.3	42.1	119.2	22.7	64.2	23.1	65.2
9.5 to 4.75	122	24.9	45.7	129.3	23.3	46.4	131.2	18.3	51.8	19.6	55.4

near the existing specification level of 10% particles exceeding the 5:1 ratio of maximum-to-minimum particle dimension. The research conducted to date generally supports the following:

- Percentage of F&E changes with handling of the stockpile and mixing.
- Aggregate breakdown during compaction increases for higher percentages of F&E.
- VMA generally increases with increasing percent F&E.
- There does not appear to be a relationship between the percentage of F&E exceeding the 3:1 ratio—in the range of approximately 10% to 40%—and performance.
- ASTM D4791 is a highly variable test procedure. Alternative methods of determining the percentage of F&E should be developed. This variability may mask relationships with performance.

2.4 METHODS OF MEASURING FAA AND THEIR RELATIONSHIP TO PERFORMANCE

2.4.1 Introduction

It has long been recognized that the characteristics of the fine aggregate component of HMA can have a significant and sometimes dominant influence on mixture rutting and fatigue cracking resistance (2, 34, 44, and 45). Kandhal et al. (46) have classified the test methods to describe aggregate angularity into two broad categories: direct and indirect. *Direct* methods are defined as those wherein particle shape or texture are measured and described qualitatively or quantitatively through direct measurement of individual particles. In *indirect* methods, particle shape and texture are determined based on measurements of bulk properties.

2.4.2 Uncompacted Voids Content in Fine Aggregate

The Superpave method specifies AASHTO T304 (ASTM C1252), “Uncompacted Void Content in Fine Aggregate, Method A,” to ensure that the *blend* of fine aggregates in an HMA mixture has sufficient internal friction to provide rut-

resistance in an HMA mixture (47). The amount of friction depends on the aggregate particle shape and texture. Higher internal friction is associated with increased rutting resistance. AASHTO T304 is commonly referred to as the FAA test. FAA levels used in the Superpave method are below 40, 40 to 45, and above 45. The higher values are specified for layers near the pavement surface and for higher traffic levels. AASHTO T304 was to be used in conjunction with the restricted zone to limit the amount of rounded natural sand in high traffic mixes.

The angularity and texture of the fine aggregate also affect the packing characteristics of the HMA and, therefore, the VMA of the compacted HMA. More angular or poorly shaped particles or particles having a high degree of texture may not pack as tightly as rounded or smooth particles and, therefore, may provide greater VMA in the compacted HMA.

The FAA test is an indirect measure of particle shape, angularity, and texture. The FAA test is based on the National Aggregate Association Flow Test (Method A) that is used to evaluate the effect of the fine aggregate on the finish ability of Portland cement concrete. The FAA value is defined as the percent air voids in a loosely compacted sample of fine aggregate. The FAA test assumes that more angular particles or particles with more surface texture will not pack together as tightly as rounded or smooth particles would.

In AASHTO T304, a 190-g sample of fine aggregate of a prescribed gradation is allowed to flow through the orifice of a funnel and fill a 100-cm³ calibrated cylinder. Excess material is struck off, and the cylinder with aggregate is weighed. The uncompacted void content of the sample is then computed using the loosely compacted weight of the aggregate, the bulk dry specific gravity of the aggregate, and the calibrated volume of the receiving cylinder.

There are three methods for running AASHTO T304: Methods A, B, and C. The mass of the sample for all three methods is fixed at 190 g. Method A specifies a known gradation ranging from material passing the 2.36-mm sieve to material retained on the 0.150-mm sieve. Method B specifies that the test be run on three individual size fractions: 2.36 to 1.18 mm, 1.18 to 0.600 mm, and 0.600 to 0.300 mm. The reported void content for Method B is the average of the results from the three individual size fractions. In Method C, the test is run on the as-received gradation (48).

The Superpave researchers chose Method A to limit the effect of gradation, particularly material passing the 0.075-mm sieve on the test result. For example, if one were to test a washed manufactured sand with a -0.075 mm sieve content of 8% and a crushed screening produced from the same aggregate and crushed with the same crusher settings with a -0.075 mm sieve content of 14% under Method C, the crushed screening would produce a lower FAA value than would the washed manufactured sand even though the two materials have identical particle shape and texture.

Several studies have been conducted to compare Methods A, B, and C (49–53). The studies have indicated a strong relationship between Methods B and C, with Method B producing uncompacted void contents almost 5 points higher (49, 51–53). Hossain et al. (49) observed that the uncompacted void contents were generally higher for smaller sized particles. Hudson (50) stated that, based on visual observation, particle shape appeared to be constant with size. Thus, particle texture may have a greater effect for smaller particles. Roque et al. (51) noted the strong effect of texture in AASHTO T304 tests. Hudson (50) states:

Test method C relates to the materials “as-is,” or “in-situ.” Little or no shape information can be determined from this method as the reduction in voids content that would be attributed to improved particle shape cannot be separated due to the influence of the sample gradation.

Researchers have also investigated the effects of alternate gradations. Hossain et al. (49) evaluated a gradation typical of dense-graded HMA that included material passing the 4.75-mm sieve and retained on the 2.35-mm sieve. Alternate gradations are strongly correlated with the Method A gradation (49, 51). The blended uncompacted voids contents were on average 2.4% lower when the material retained on the 2.36-mm sieve was included (49). Hudson (50) stated that the current AASHTO T304 equipment was not suitable for testing the material passing the 4.75-mm sieve and retained on the 2.36-mm sieve because the outlet orifice and the receiving container were both too small. Virginia Test Method 5, which uses an enlarged version of the AASHTO T304 apparatus, produced identical uncompacted void contents when the Method A grading was tested in both devices (53). Based on the preceding research, altering the AASHTO T304 Method A gradation or fixtures would appear to shift uniformly the uncompacted void contents for all aggregates.

Several concerns have been expressed regarding the use of the FAA test as a screening tool for rutting resistance of fine aggregate. There is concern that some 100% crushed particles do not meet the minimum requirements (>45) for mixes used in the upper 100 mm of the pavement structure with traffic levels in excess of 3 million ESALs during the design life (54). Typically, these particles are extremely cubical in nature. A second concern is that particles passing the 4.75-mm sieve but retained on the 2.36-mm sieve are not evaluated for angular-

ity or shape under the current Superpave aggregate properties (52). Work by Hudson (50) indicates that the current AASHTO T304 apparatus may not be appropriate for testing particles in this size range. A third concern is related to the variability of the test procedure and its dependence on the fine aggregate dry bulk specific gravity (52).

Finally, there is concern that the FAA test may not be related to the rutting propensity of the HMA mixture. These concerns led to numerous studies evaluating the FAA test as well as alternative tests to relate FAA, shape, and texture to the rutting performance of HMA mixtures. Commonly used alternative tests will be discussed prior to efforts to relate FAA to HMA performance.

2.4.3 Alternative Methods of Measuring FAA

2.4.3.1 Direct Tests (Digital Imaging Methods)

In the past few years, digital image processing technique has been introduced into the HMA industry to analyze macro- and microstructures of HMA, aggregates, air voids, gradation, and so on. Several researchers have attempted to use image analysis to measure the FAA. Particle shape from image analysis, automated image analysis, and morphology analysis from profile images and from 3-D images are some of the image analysis methods being used actively in recent years.

Particle Shape from Image Analysis: This automated technique was developed at the University of Arkansas for FHWA (55). The fine aggregate is spread on a glass plate, and a high-resolution video camera is used to capture the image of each particle. Modern digital imaging hardware, image analysis techniques, and computerized analysis were used to quantify aggregate shape. EAAP (ellipse-based area of the object divided by the perimeter squared) Index and Roundness Index were found to have the most potential for predicting rutting performance.

Automated Image Analysis: The automated image analysis approach was developed by Massad et al. (56). Two procedures—surface erosion-dilation technique and fractal-behavior technique—were used to quantify FAA. The surface erosion-dilation technique consists of subjecting the aggregate surface to a smoothing effect that causes the angularity elements to disappear from the image. The aggregate angularity is measured in terms of a surface parameter, which is defined as the area lost during the erosion-dilation process as a percentage of the total area of the original image.

The fractal-behavior technique uses image-analysis techniques to capture the aggregate boundary. Fractal length of the boundary is the slope of effective-width-to-number-of-cycles relationship. The fractal length increases with aggregate angularity.

Morphology Analysis from Profile Images and 3-D Images:

Similar techniques have been applied by Wang and Mohammad (57) and Kecham and Shashidhar (58) to evaluate particle size, shape, angularity, and texture of aggregate.

2.4.3.2 Indirect Tests**Standard Test Method for Index of Aggregate Particle Shape and Texture (ASTM D3398):**

In this test method, the sample is first broken down into individual sieve fractions. Thus, the gradation of the sample is determined. Each size of material is then separately compacted in a cylindrical mold using a tamping rod at 10 and 50 drops from a height of 2 in. The mold is filled completely by adding extra material so that it levels off with the top of the mold. The weight of the material in the mold at each compactive effort is determined, and the percent voids is computed. A particle index for each size fraction is then computed, and, using the gradation of the sample, a weighted average particle index for the entire sample is also calculated (16).

Direct Shear Test (ASTM D 3080): The direct shear test (DST) method is used to measure the angle of internal friction of a fine aggregate under different normal stress conditions. A prepared sample of the aggregate under consideration is consolidated in a shear mold. The sample is then placed in a direct shear device and sheared by a horizontal force while known normal stress is applied (16). DST is probably the most straightforward way to determine the stress-dependent shear strength of fine aggregate. Research conducted by Fernandes et al. (59) found that direct shear strength may provide a more relevant parameter to evaluate fine aggregates. The researchers also stated that the DST is significantly more complex and less repeatable than the FAA test, and its relation to the performance of fine aggregates needs to be further verified and developed.

CAR Test: The CAR test method was developed to evaluate shear resistance of compacted fine aggregate (60, 61). It is similar to the Florida bearing ratio test (61). In this method, fine aggregates are compacted in a 100-mm mold following the Marshall hammer method using 50 blows applied to only one face of the specimen. The compacted sample height was maintained as 63.5 mm. The CAR stability was measured by applying a compressive load using the Marshall test machine. The compacted sample, while still in the mold, is placed in the Marshall test machine in the upright position. A load of 50 mm/min is transmitted through a 37.5-mm-diameter steel cylinder on the plane surface of the compacted sample. The highest load that one specimen can carry was reported as the CAR stability value. This test is believed to be a performance-related method of measuring FAA (61).

2.4.4 Relationships Between Fine Aggregate Shape, Angularity, and Texture and HMA Performance**2.4.4.1 Introduction**

The following section describes 12 studies relating FAA to HMA performance. Because of the controversy over the fine aggregate uncompacted voids test, the studies are discussed individually and in some detail.

2.4.4.2 NCAT National Rutting Study by Cross and Brown

Cross and Brown (17) reported relationships between aggregate properties and field rut depth obtained from a national rutting study. The study indicated the aggregate properties had little relationship with rutting when the in-place air voids of the pavement section were less than 2.5%; however, relationships between aggregate properties and field rut depths were observed for pavement sections with in-place air void contents in excess of 2.5%. A relationship with an $R^2 = 0.67$ was determined between the National Aggregate Association (NAA) Flow Test Method A, which is the basis of AASHTO T304, and the pavement rut depth divided by the square root of the applied ESAL. The relationship was developed from the analysis of data from 13 pavements. The pavement rut depth divided by the square root of ESALs was used to account for the fact that greater truck traffic was likely to produce greater pavement rut depths.

A rutting model with an $R^2 = 0.77$ was developed between rate of rutting and aggregate properties with data from pavements with in-place air voids in excess of 2.5%. The aggregate properties considered included coarse aggregate crushed faces, uncompacted voids in fine aggregate, gradation parameters, and both nominal and maximum aggregate size divided by lift thickness (17). Only two factors—percent of coarse aggregate with two or more crushed faces and uncompacted voids in fine aggregate—were included in the model (Equation 1).

$$P = 0.080038 - 0.00008(CF) - 0.00151(NAA) \quad (1)$$

where

P = predicted rate of rutting, rut depth (mm)/square root ESAL;

CF = two or more crushed faces in coarse aggregate (%); and

NAA = NAA uncompacted voids, (%).

In 1992, Cross and Brown (10) reported that a rutting rate of 0.005842 mm per square root ESALs delineated good performing pavements from rutted pavements. Using this crite-

tion and the relationship between the NAA flow test and rutting rate (17), Kandhal et al. (20) determined a minimum uncompacted voids content of 43.3%. Cross and Brown (17) developed several additional models relating uncompacted voids content and air void contents of recompacted specimens using various compaction methods.

2.4.4.3 Evaluation of Particle Shape and Texture of Mineral Aggregates Used in Pennsylvania by Kandhal et al.

Kandhal et al. (20) evaluated 18 sources (8 natural and 10 manufactured) of fine aggregate from Pennsylvania using ASTM D3398 and both Methods A and B of the NAA uncompacted voids test. They observed an overlap between the natural and manufactured sands in that one manufactured sand, a limestone, produced both a particle index (12.8) and an NAA uncompacted void contents (Method A = 43.1) that were lower than those of several natural sands. The authors concluded that a minimum particle index of 14 and NAA uncompacted voids content Method A of 44.5 separated between natural and manufactured sands with confidence levels of 86% and 82%, respectively.

During the development of the Superpave method, an expert panel using a modified Delphi process determined the consensus aggregate properties (1). During the fifth round of questionnaires used as part of the Delphi process, the expert panel recommended minimum uncompacted voids of 42.8% for pavements with design traffic levels less than 300,000 ESALs and 44.2 for pavements with design traffic levels less than 10 million ESALs. These values represented the expert panel's average recommendations for pavement layers in the top 50 mm of the pavement structure. The recommended uncompacted void levels were reduced to 41.4% and 42.8%, respectively, for layers at a depth of 127 mm.

2.4.4.4 Evaluation of Natural Sands Used in Asphalt Mixtures by Stuart and Mogawer

Stuart and Mogawer (62) conducted a study to evaluate different methods of measuring fine aggregate shape and texture. Twelve materials were evaluated in the study: five natural sands with a poor performance history, four natural sands with a good performance history, and three manufactured (crushed) sands with a good performance history. Five methods were used to characterize the sands: NAA uncompacted voids Method A, DST, ASTM D3398, Michigan Test Method 118-90, and a flow rate method. Michigan test method 118-90 is similar to the NAA uncompacted voids test in that the volume of voids in a loosely compacted sample is used to determine the air voids-to-solids ratio and, in turn, an angularity index. The volume of voids is determined in water in a grad-

uated cylinder, which eliminates the need for a bulk specific gravity; however, the results are affected by the aggregate absorption. Based on Michigan DOT's survey responses, this test method has been replaced by AASHTO T304. The flow rate test uses the NAA apparatus. The flow rate is determined by dividing the volume of a 500-g sample of fine aggregate by the time it takes to flow through the NAA orifice. A shape-texture index is calculated from the flow time by dividing the flow time from a standard set of steel balls by the flow time for the fine aggregate. Standardized gradations were used for the study. Previous studies had evaluated the as-received gradations and recommended a standardized gradation for the NAA uncompacted voids test, Michigan Test Method 118-90, and flow rate test (63).

The twelve sands were ranked by each of the test methods based on the average test value. The best method of differentiation was the flow time test. This was also the easiest parameter to obtain. ASTM D3398 correctly differentiated all of the poor-quality sands from the good-quality sands. The weighted particle index that divided good- and poor-performing materials was between 11.7 and 13.9. NAA uncompacted voids Method A ranked one of the poor-quality materials the same as one of the good-quality materials. Both had an uncompacted voids content of 44.7%. However, the test procedure for the poor sand was violated because the sand did not have size fractions retained above the 0.600-mm sieve. Thus three size fractions were excluded from the standard. Mogawer and Stuart (63) concluded that 44.7% uncompacted voids would divide good- and poor-performing sands for high traffic levels. The remaining methods, Michigan Test Method 118-90 and the DST, did not differentiate the sands as well. The authors noted that the DST was time consuming.

Attempts were made to differentiate between the rutting performance of HMA produced with four of the sands, two of good quality and two of poor quality. Twelve aggregate blends with levels of 10%, 20%, and 30% of each of the sands were tested with the GLWT, the French Laboratoire Central des Ponts et Chaussées (LCPC) Pavement Rutting Tester, and the USACE's Gyrotory Testing Machine. The remainder of the mix was made up of a good-quality traprock coarse aggregate and traprock crushed sand. Unfortunately, none of the rutting tests differentiated between the performance of the sands. This was most likely due to the high quality of the other aggregates (crushed traprock) used in the blend (62).

Stuart and Mogawer (62) presented three additional important conclusions:

1. Methods for measuring shape and texture can only be expected to group sands into performance categories, such as high or low potential for rutting. The performance of a sand depends on its quality, the quantity used, the qualities of the other aggregates, and the traffic level.

2. Each sand should be tested to determine its rutting potential. The methods are not sensitive enough to evaluate the blend of materials found in a job-mix formula gradation.
3. The discrepancies provided by the NAA and the Michigan DOT methods may be related to gradation. A single, standard gradation should be used in these methods so that the voids that they provide are only a function of shape and texture.

2.4.4.5 Investigation of the Influence of Aggregate Properties on Performance of Heavy-Duty HMA Pavements by Ahlrich

Ahlrich (19) reported an investigation of aggregate particle shape and texture on the permanent deformation properties of HMA meeting the Federal Aviation Administration's P-401 specification. Eleven blends meeting the P-401 gradation band were produced with varying amounts of crushed coarse aggregate (0%, 30%, 50%, 70%, and 100%) and varying amounts of natural sand (0%, 10%, 20%, 30%, and 40%). The blends were produced using crushed limestone, crushed gravel, and uncrushed gravel. The fine aggregate portion of the blends was evaluated by visual inspection of the percent crushed particles according to CRD-C-171, ASTM D3398 (Particle Index Test), and ASTM C1252 Methods A and C (FAA test). The uncompacted voids contents of the fine aggregate portion of the 11 blends as measured by ASTM C1252 Method A ranged from 38.4% to 47.1%. ASTM D3398 and ASTM C1252 Method A both produced strong correlations ($R^2 = 0.98$) with the percent crushed particles (minimum two fractured faces). ASTM C1252 Method A produced the best correlation with the percent of (rounded) natural sand in the blend ($R^2 = 0.94$). ASTM C1252 Method C produced lower R^2 values with both the percent crushed faces and percent natural sand ($R^2 = 0.66$ and $R^2 = 0.71$, respectively).

A volumetric mix design was performed for each of the 11 blends using the USACE's Gyratory Testing Machine. The samples were prepared with AC-20 (approximately PG 64-22). Samples were tested using a triaxial (confined) repeated load creep test at 60°C. Three properties were used to evaluate the rutting propensity of the mixtures: permanent strain, creep modulus, and slope of the deformation curve. The composite (coarse and fine aggregate) particle index measured by ASTM D3398 produced the best correlation with all three parameters ($R^2 = 0.78$, 0.69, and 0.71, respectively). ASTM C1252 Method A produced better correlations with all three parameters than the other two fine aggregate tests (ASTM D3398 and percent crushed particles). The R^2 values ranged from 0.29 to 0.41. The better correlation with the composite aggregate index from ASTM D3398 is not unexpected because the coarse aggregate fraction was also varied between the blends. Ahlrich (19) concluded,

On the basis of the strong correlations and simple test procedure, the promising alternatives for specification require-

ments to characterize aggregate particle shape and texture instead of percent crushed particles are modified ASTM C1252 for the coarse aggregate fraction and ASTM C1252 for the fine aggregate fraction.

2.4.4.6 Study of the Contribution of FAA and Particle Shape to Superpave Mixture Performance by Huber et al.

Huber et al. (34) conducted a study to assess the contribution of FAA and particle shape to the rutting performance of a Superpave-designed HMA. Four fine aggregates were selected for the study: a Georgia granite; Alabama limestone; Indiana crushed sand (geology not identified, most likely limestone); and Indiana natural sand. The uncompacted void contents (AASHTO T304 Method A) of the four aggregates were measured as 48, 46, 42, and 38, respectively. A reference mixture was prepared with the Georgia granite (coarse and fine aggregate) and a PG 67-22 binder. The other three aggregates were sieved into size fractions and substituted for the granite fine aggregate to produce four mixtures, keeping the gradation constant. All four blends were mixed at the optimum asphalt content determined for the granite blend. No adjustment was made for variances in asphalt absorption between the fine aggregates.

The resulting mixtures were tested in the Couch Wheel Tracker (a modified Hamburg Wheel Tracker), the APA, and the SST using the frequency sweep test. The rutting tests did not appear to differentiate between the blends in a consistent manner or at all in some cases. The authors concluded that the choice of coarse aggregate may have masked the effect of the fine aggregate (34). There was not a correlation between any of the tests and the uncompacted void contents. This finding is not unexpected because there were not significant differences between the rutting results.

2.4.4.7 NCHRP Project 4-19 by Kandhal and Parker

NCHRP Project 4-19, "Aggregate Tests Related to Asphalt Concrete Performance in Pavements," (2) evaluated fine aggregate tests related to rutting performance. Three tests were used in the study: ASTM D3398, AASHTO T304 Method A, and particle shape from image analysis (the University of Arkansas Method). Used in this study were nine fine aggregate sources with a range in uncompacted void contents of 40.3% to 47.5%. Three of the materials were natural sands. The fine aggregates were mixed with an uncrushed gravel coarse aggregate. All of the mixes were produced using the same gradation, above the maximum density line. The coarse aggregate and gradation were chosen to emphasize the response of the fine aggregate. The aggregate was mixed with a PG 64-22 binder. A mix design was conducted for each mixture using

an N_{design} level of 119 gyrations to determine optimum asphalt content.

The resulting mixtures were tested using the GLWT and the SST. Simple shear at constant height and frequency sweep at constant height were performed using the SST. Poor correlation coefficients were observed between all three fine aggregate tests and the SST results. The index of aggregate shape and particle texture from ASTM D3398 produced the best correlation with the GLWT rut depths ($R^2 = 0.67$). The uncompacted void contents produced a slightly lower correlation ($R^2 = 0.60$). The authors noted that the uncompacted voids were highly correlated with the aggregate index ($R^2 = 0.99$) and that the uncompacted voids test was much simpler to run. They therefore recommended AASHTO T304 to quantify fine aggregate particle shape, angularity, and surface texture. The Roundness Index from the University of Arkansas digital image analysis produced a fair correlation with the GLWT rut depth ($R^2 = 0.56$).

2.4.4.8 Study of the Effect of FAA on Asphalt Mixture Performance by Lee et al.

Lee et al. (64) conducted a study on the effect of FAA on HMA performance for the Indiana Department of Transportation. The study included six fine aggregate sources, which were used to produce 18 9.5-mm NMAS mixtures using different gradations and blends of the fine aggregate. Only one of the fine aggregate sources was a natural sand. The coarse aggregate used for all 18 mixtures was a partially crushed (80% one crushed face) gravel. The angularity and texture of the fine aggregate sources were evaluated using ASTM C1252 Method A (FAA test), CAR test, and Florida Bearing Value (Indiana Test Method 201-89). The Florida Bearing Value is a precursor to the CAR test. Instead of using a Marshall press, the sample was loaded through the flow of lead shot into a receiving container. The uncompacted voids content of the fine aggregate ranged from 38.7 to 49.0. Blends of the six sands were prepared to produce uncompacted void contents of 46, 45, and 43. Regression analysis indicates an $R^2 = 0.70$ between the uncompacted voids and CAR peak load. The trend indicated an increase in CAR peak load with an increase in uncompacted voids.

Volumetric mix designs were conducted for each of the 18 mixtures. The first nine mixtures were produced one each with the six sands and three blends of those six sands. Nine additional mixtures were produced, five using a slag sand with varying percentages of natural sand and mineral filler and four with a limestone sand (S gradation mix) and different percentages of natural sand. Rut testing was performed on the mixtures using the PurWheel Laboratory Tracking Device and the SST. The PurWheel device applies loads to the slabs of HMA with a rubber wheel having a contact pressure of 620 kPa. PurWheel testing was conducted on dry slabs at 60°C. SST testing for frequency sweep at constant

height and repeated shear at constant height were performed according to AASHTO TP7-94.

Correlation analysis between the three fine aggregate tests and rutting performance based on both repeated shear at constant height and the PurWheel rut depths indicated that the uncompacted voids content was most correlated with rutting performance (64). A stepwise regression was performed to predict the rutting performance of the mixtures using the PurWheel. The independent variables considered were uncompacted voids content, asphalt content, air voids content (of the PurWheel samples), dust to asphalt ratio, gradation parameters, the interaction between uncompacted voids and asphalt content, and the number of loading cycles to 2% shear strain from the repeated shear at constant height test. Six of the eight variables were included in the model by the stepwise regression: uncompacted voids, asphalt content, air voids, the interaction between uncompacted voids and asphalt content, cycles to 2% strain in the SST, and gradation. The uncompacted voids content was the most significant parameter (F -value = 41.00). Comparing the aggregate properties individually to the rutting results from the PurWheel device and repeated shear at constant height, FAA had the highest correlation with the PurWheel results ($R^2 = 0.40$) and the Florida Bearing Ratio had the highest correlation with the repeated shear at constant height ($R^2 = 0.29$). The authors concluded that uncompacted voids alone may not be sufficient to evaluate the fine aggregate contribution to mixture rutting performance. It was observed that a mixture having an uncompacted voids content of 43 performed as well as a mixture with an uncompacted voids content of 48. The authors note that this may be due to the confounding effects of gradation and compactability (the uncompacted voids content of 48 represents the slag mixtures).

2.4.4.9 Pooled Fund Study 176

One of the goals of the National Pooled Fund Study No. 176, "Validation of SHRP Asphalt Mixture Specifications Using Accelerated Testing," was to examine the effect of FAA on the rutting performance of Superpave mixtures. Two coarse aggregates—a limestone and granite—and three fine aggregates—a natural sand, limestone sand, and granite sand—were used in the study (65). The fine aggregates had uncompacted void contents of 39, 44, and 50, respectively. The aggregates were combined with a neat PG 64-22 to produce 21 mixture designs: 9 of 9.5-mm NMAS and 12 of 19.0-mm NMAS. A trend was observed between the design asphalt content and the uncompacted voids content. The relationship indicated that for a given gradation shape (above, through, or below the maximum density line), optimum asphalt content increased with increasing uncompacted voids.

The rutting propensities of the mixes were tested with the PurWheel, the SST, and Triaxial Tests and in the APT facility. The APT facility is a full-scale, indoor accelerated loading facility managed by Indiana DOT and Purdue University.

The primary goal of the Phase I testing was to evaluate the sensitivity of the various test methods to the study factors (66). Based on screening tests performed with the PurWheel device in Phase I of the study, four mixtures were selected for APT facility testing. A limestone coarse aggregate was used to produce 19.0-mm NMAS mix designs using all three sands. The natural sand (FAA 39) and limestone sand (FAA 44) were used to produce coarse-graded mixes (below the maximum density line). The limestone sand and granite sand were used to produce fine-graded mixes (above the maximum density line). These four mix designs were placed at both low and high in-place densities.

The results of the APT facility testing are shown in Table 7. It is apparent that both mixtures produced with the limestone sand (FAA 44) had design asphalt contents that were approximately 1 percentage point less than the mixtures produced with the natural or granite sand. For the low-density sections, the crushed limestone sand (FAA 44) produced both the best and worst rutting results in the APT facility; however, the dry PurWheel results ranked both of the limestone sand mixtures as performing the best. For the high-density (low air void) sections, the limestone sand mixtures performed best in both

the PurWheel and the APT facility. However, it should be noted that the air void contents of the natural sand and granite fine aggregate sections were close to the 2.5% level identified by Cross and Brown (10, 17) below which mixtures were less sensitive to aggregate properties. The air void contents of the limestone fine aggregate sections (FAA 44) were approximately 2.5 percentage points higher than the natural sand and granite fine aggregate sections. These variations were not planned but are part of the variation associated with full-scale test sections. Thus, although the limestone fine aggregate indicated the best rutting performance for the high-density sections, this result may be more related to the higher in-place air voids and lower asphalt contents of those mixtures than to the performance of the fine aggregate. This emphasizes the fact that screening tests for FAA and texture cannot by themselves ensure mixture performance.

In Phase II of Pooled Fund Study 176, an additional 6 mixtures were tested in the APT facility for a total of 10 mixtures and in excess of 20 sections (considering varying densities and asphalt contents). Stiadny et al. (67) discussed the findings relative to aggregate. Based on Figure 5, the rounded natural sand (FAA 39) produced the worst rutting performance;

TABLE 7 INDOT/Purdue APT facility results from Phase I of Pooled-Fund Study 176 (65)

Mixture (FAA, Gradation)	Design Asphalt Content, %	Average As-Constructed Wheel Path Air Voids, %	APT Rut Depth, mm (Adjusted for 76-mm layer thickness)	PURWheel Dry Test Ranking
<i>Low Density Sections</i>				
44 ARZ	4.6	8.8	5.3	1
50 ARZ	5.9	6.4	6.3	3
39 BRZ	5.5	5.2	9.4	4
44 BRZ	4.6	6.4	11.8	2
<i>High Density Sections</i>				
44 ARZ	4.6	5.3	4.3	1
44 BRZ	4.6	5.7	8.0	2
50 ARZ	5.9	2.9	9.3	3
39 BRZ	5.5	2.6	15.7	4

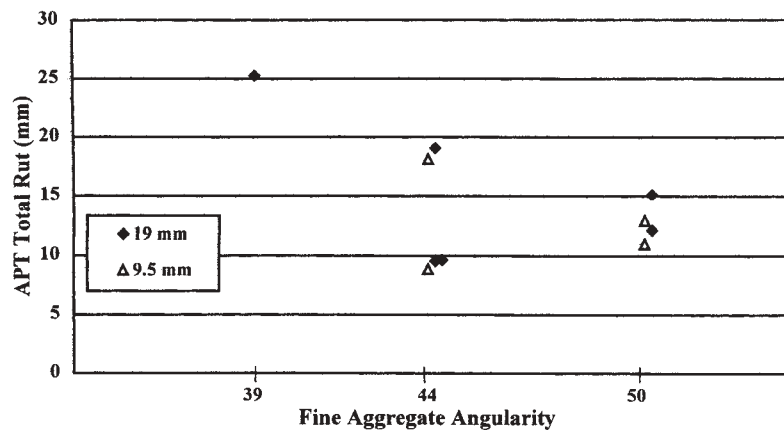

Figure 5. APT facility rutting versus uncompacted voids content by gradation type (67).

however, the limestone fine aggregate (FAA 44) performed as well or better than the granite fine aggregate (FAA 50). The mix designs produced with the granite fine aggregate had consistently higher asphalt contents. Analysis of variance (ANOVA) performed on the triaxial shear strength test results from the 21 mixtures indicated that the uncompacted void contents for the fine aggregates in the mixtures were a significant factor (66).

2.4.4.10 Evaluation of Superpave FAA Specification by Chowdhury et al.

Chowdhury et al. (54) conducted a study to evaluate various measures of FAA and texture and their relationship to rutting performance. The study was conducted for the International Center for Aggregate Research. The study evaluated 23 fine aggregates using seven different procedures: uncompacted voids content (AASHTO T304), DST (ASTM D3080), CAR test, three different methods of digital image analysis, and visual inspection. The image analysis techniques included the Hough Transform by the University of Arkansas, which was discussed previously; unified image analysis by Washington State University; and the VDG-40 Videograder conducted by the Virginia Transportation Research Council.

The samples tested by Washington State University were sieved, and only the material passing the 1.18-mm sieve and retained on the 0.600-mm sieve was used for analysis. The aggregates were stained black to improve their contrast with the background prior to capturing the images. An optical microscope linked to an image analyzer was used to capture images of the fine aggregate. Three techniques were used to analyze the binary image: surface erosion-dilation, fractal behavior, and form factor (56). Surface erosion-dilation involves removing layers of image pixels on the fringe of the

object (i.e., erosion) followed by replacement of these pixels (i.e., dilation) to simplify the form. The surface parameter is believed to be a measure of angularity and is calculated as the percentage of the particle area lost after six cycles of erosion followed by six cycles of dilation (56). Fractal behavior is defined “as the self-similarity exhibited by an irregular boundary when captured at different magnifications” (56). Fractal length increases with an increase in aggregate angularity. Form factor describes an object’s dimensions, particularly surface irregularity. The form factor of a perfectly circular object is 1; therefore, form factor decreases with increasing surface irregularity.

The VDG-40 Videograder was developed by LCPC, the French national road and bridges laboratory (68). The device was developed primarily to measure aggregate grading of particles larger than 1 mm (No. 16 sieve), but it can also measure shape properties. Aggregates are backlit as they fall in front of a linear charged couple device camera, which produces a line scan image of the aggregate. The aggregates fall off a rotating wheel, which prevents them from tumbling as they fall in front of the camera. An ellipse having the same length and area is fit to each particle. The ratio of the length to the width of each particle is reported as the slenderness ratio (SR). The SR may be determined as a distribution or an average. The flatness factor is a property for the group of aggregates tested; it is related to the ratio of the average width to average thickness of the particles.

Based upon the data presented in the paper (54), a correlation matrix was developed between the indices for angularity determined with each test method (Table 8). (See Chowdhury et al. for some of the correlations [54, 69].) Regression analysis was performed using Minitab statistical software. The upper number in the cell is the coefficient of determination (R^2) and the lower number is the significance level (p -value) based on the ANOVA.

TABLE 8 Correlation matrix for fine aggregate test results using data from Chowdhury et al. (54)

Test Procedure	UV, AASHTO T304 Method A	Angle of Internal Friction (AIF) ASTM D3080	Log CAR Stability	University of Arkansas K-index	University of Washington Surface Parameter (SP)	VDG-40 Slenderness Ratio (SR)
UV	1.00 ¹ 0.000 ²	0.07 0.222	0.17 0.050	0.76 0.000	0.72 0.000	0.47 0.000
AIF		1.00 0.000	0.53 0.000	0.06 0.244	0.05 0.292	0.22 0.028
Log CAR			1.00 0.000	0.20 0.031	0.16 0.061	0.72 0.000
K-index				1.00 0.000	0.69 0.000	0.50 0.000
SP					1.00 0.000	0.43 0.001
SR						1.00 0.000

¹Coefficient of determination (R^2)

²ANOVA level of significance (p -value)

The uncompacted voids content correlated well with two of the digital imaging methods, K-index ($R^2 = 0.76$) and surface parameter ($R^2 = 0.72$), and had a fair correlation with the SR ($R^2 = 0.47$). The relationships between uncompacted voids and all three direct measures of fine aggregate particle shape were significant based on the ANOVA. The authors noted that four crushed limestone aggregates that have good field performance histories showed high values of K-index even though their uncompacted voids contents were less than 45 (54). Kandhal and Parker (2) also found a good relationship between the EAPP (i.e., ellipse-based area of the object divided by the perimeter squared) and uncompacted voids content ($R^2 = 0.76$) as measured by the University of Arkansas Hough Transform. Uncompacted voids content correlated poorly with both angle of internal friction (AIF) and the Log of CAR stability.

There was a fair correlation between the two shear measurements, AIF and Log of CAR stability ($R^2 = 0.53$). AIF did not correlate well with any other test, although the relationship with the VDG-40 SR was significant (p-value = 0.028). Log of CAR stability correlated well with the VDG-40 SR ($R^2 = 0.72$). There was a fairly good correlation between K-index and surface parameter ($R^2 = 0.69$); both methods had moderate correlations with the VDG-40 SR. The authors noted (54):

The CAR test appears to separate uncrushed and crushed aggregates much better than the FAA test. This could be, in part, due to the high filler content of the crushed materials as compared to the sands.

A laboratory rutting study was conducted with four of the fine aggregates: three crushed materials and one natural sand. Two blends of materials were also produced using two of the crushed materials, one with 15% and the other with 30% of the natural sand. A single limestone coarse aggregate and a coarse 19.0-mm NMA gradation were used for all of the mixtures. The binder grade was not reported. Superpave mix designs were performed for each of the six blends. The mixtures produced using the natural sand and blend with 30% natural sand did not meet the Superpave minimum VMA requirements.

Cylindrical samples at $4 \pm 1\%$ air voids were tested in the APA at 64°C with a 445-N (100-lb) vertical load and 694 kPa (100 psi) hose pressure. Regression analysis indicated a fair to poor relationship ($R^2 = 0.37$) between uncompacted voids and APA rut depth (54). The mix with 100% natural sand fines (FAA = 39.0) had the highest rut depth (9.2 mm) followed closely by the mix with the crushed river gravel fines (FAA = 44.3, rut depth = 9.1 mm). The mix containing the crushed river gravel had the highest asphalt content of all of the mixes evaluated (tied with granite/natural sand blend). The mix with the granite fines (FAA = 48.0) had the least amount of rutting (4.0 mm), followed closely by the mix with the limestone fines (FAA = 43.5, rut depth = 4.4 mm). This illustrates the concern with the current uncompacted voids

specifications. Based on laboratory results, it is possible to design mixes using fine aggregate that fails the uncompacted voids criteria but produces acceptable rutting performance. Regression analysis using data provided by Chowdhury et al. (54) did indicate a good relationship between uncompacted voids and VMA ($R^2 = 0.70$). This suggests that uncompacted voids may also identify fine aggregates that will assist in meeting minimum VMA requirements.

Angle of internal friction, as tested by ASTM D3080, produced the best relationship ($R^2 = 0.69$) with the APA rut depths (54). Log of CAR stability and the VDG-40 SR produced fair correlations ($R^2 = 0.46$ and 0.42 , respectively). No correlation ($R^2 = 0.07$) was found with the Washington State University surface parameter discussed previously, but a fair correlation ($R^2 = 0.58$) was found with a second parameter, fractal length.

2.4.4.11 Evaluation of Superpave Criteria for VMA and FAA for Florida DOT by Roque et al.

Roque et al. (51) conducted a study on FAA for the Florida DOT. A total of nine fine aggregates were included in the study: six limestone sources, two granite sources, and a gravel source. The fine aggregates were evaluated using AASHTO T304 Methods A, B, and C as discussed previously; using the ASTM D3080 (DST); and visually. Two alternative gradations, other than that specified in AASHTO T304 Method A, were also evaluated (51, 59). These gradations were selected to represent the range of fine aggregate gradations used in the study. The authors concluded that “material type had a far greater effect on FAA than did gradation. Furthermore, all three gradations appeared to result in the same relative FAA rankings for the fine aggregates tested” (51). A poor correlation ($R^2 = 0.32$) was observed between the uncompacted voids content and direct shear strength when both tests were conducted using the AASHTO T304 Method A gradation. The trend indicates decreasing shear strength with increasing uncompacted voids content. This may be due to the packing characteristics of the fine aggregates with higher uncompacted voids contents. The authors conclude that “although FAA had some influence on the shear strength, aggregate toughness and gradation appeared to overwhelm its effects, confirming that FAA alone was not a good predictor of fine aggregate shear strength” (51).

Five of the fine aggregate sources, three limestone sources, a granite source, and a gravel source were used to evaluate the effect of fine aggregate on mixture performance. A single limestone source was used as the coarse aggregate and to develop a reference coarse and fine gradation commonly used in Florida. The four other fine aggregates were used to volumetrically replace the reference aggregate. The material passing the 4.75-mm sieve was replaced for the coarse gradation,

and the material passing the 2.36-mm sieve was replaced for the fine gradation. Volumetric replacement was done to account for any differences in specific gravities between the materials.

Superpave mixture designs were performed for each of the 10 blends using $N_{\text{design}} = 109$ compaction level. The binder grade was not reported. Six of the ten mix designs failed one or more Superpave criteria. Two of the three limestone sources failed minimum VMA (14% minimum for 12.5-mm NMAS). The granite source failed the voids filled with asphalt (VFA) requirements on the high side because of a high VMA (16%). The authors noted that “the FAA did appear to identify substandard VMA mixtures” (51).

Rutting tests were performed with the APA. Test temperature and loads used in the APA were not reported. The results for the fine mixtures are reported by Roque et al. (51). The authors state that the rutting results agree with the direct shear results, aggregate toughness, and known field performance. The trend between uncompacted voids and APA rut depths indicated decreased rutting with increasing uncompacted voids. Two fine aggregates with uncompacted voids less than 45 and high toughness (LA abrasion < 35%) exhibited a rut depth equivalent to a fine aggregate with an uncompacted voids content in excess of 45. Roque et al. (51) recommend including aggregate toughness as part of the AASHTO T304 acceptance criteria. Aggregates with uncompacted voids between 42 and 50 would be acceptable with LA abrasion values of the parent rock less than 35%. If the LA abrasion of these fine aggregates were to exceed 35%, their rutting performance may not be adequate.

2.4.4.12 Evaluation of the Effect of FAA on Compaction and Shearing Resistance of Asphalt Mixtures by Stackston et al.

Stackston et al. (70) conducted a study to evaluate the effect of FAA on compaction effort and rutting resistance. Three aggregate sources were used in the study. Twenty-four Superpave mix designs were developed using blends of the three materials and two gradation shapes: fine and s-shaped. The response of the mixtures was evaluated using Superpave volumetric properties and the gyratory load plate assembly. The gyratory load plate assembly measures the force on the sample at three points. This force is converted to a force per cycle. Testing indicated that the density at N_{initial} decreases with increasing uncompacted voids content. This indicates that mixes with higher uncompacted voids contents would be less likely to be tender mixes. Data from the gyratory load plate assembly indicated that mixes with higher uncompacted voids contents are harder to compact. The authors reported that the effect of uncompacted voids content was not consistent in terms of rutting resistance as measured by the gyratory load plate assembly (70).

2.4.4.13 NCHRP Project 4-19(2)

Ongoing research as part of NCHRP Project 4-19(2), “Validation of Performance-Related Tests of Aggregates for Use in Hot-Mix Asphalt Pavements,” is examining the relationship between uncompacted voids tests and rutting through accelerated testing using the Indiana prototype APT facility. Six fine aggregates were initially selected for the fine aggregate characterization portion of the study: crushed gravel, granite, dolomite, traprock sands, and two natural sands. The uncompacted void contents (Method A) for these sands ranged from 40.3 to 49.1 (23). Later, alternative dolomite and traprock sands were included that produced HMA mixtures with better volumetric properties (uncompacted void contents of 46.8% and 49.2%).

The study tracked the measured uncompacted void contents from the HMA mix design through field construction. On average, a 1.8% reduction in voids was observed between the HMA mix design value and material recovered from HMA samples taken at the asphalt plant. Rismantojo states that “the degradation was significantly correlated with the initial UVA [uncompacted voids] values. Fine aggregates with high initial UVA values appeared to degrade more than those with low UVA values” (23).

Mixture designs were performed with all eight fine aggregates using a single uncrushed gravel coarse aggregate to amplify the effect of the fine aggregate. The original dolomite and traprock sources produced VMA values that were excessively high (17.4% and 18.0% at $N_{\text{design}} = 100$ gyrations). This resulted in failing VFA values (exceeding 75%). The mixtures produced using the other original fine aggregates and two replacement aggregates met all of the Superpave criteria. Correlations were performed between the volumetric properties and measured fine aggregate properties. Uncompacted voids produced a significant correlation ($R^2 = 0.59$) with density at N_{initial} (23). A model was developed to relate uncompacted voids and dust proportion to VMA. As expected, VMA increased with increasing uncompacted voids and decreasing dust proportion (23).

The six mixtures with passing Superpave volumetric properties were tested in the full-scale Indiana APT facility. The results indicate that uncompacted voids Methods A and B as well as the uncompacted voids from Virginia Test Method 5 (VTM 5) were significantly related to the total rut depth after 1,000 passes. The $R^2 = 0.65$ for Method A was slightly less than for the other two methods. AASHTO T304 Method A produced the best relationship with the total rut depth after 20,000 passes ($R^2 = 0.51$); however, the relationship was not significant (p -value = 0.286) (23). The author noted that the decrease in rut depth with increasing uncompacted voids occurs to a lesser extent above 45% voids. Rismantojo (23) concludes that the results of the current study are similar to those reported by Kandhal and Parker (2), including that fine-graded mixtures with uncompacted voids contents (Method A) between 42% and 46% demonstrate similar levels of rutting resistance.

2.4.5 Precision of AASHTO T304

AASHTO T304 reports a single-operator standard deviation (Std) of 0.13% voids and a multilaboratory standard deviation of 0.33% voids (71). This means that two properly conducted tests should not differ (D2S) by more than 0.37% and 0.93% voids, respectively, for a single operator and between two different labs. AASHTO T304 testing is included as part of the AASHTO Materials Reference Laboratory (AMRL) proficiency samples testing program. The precision results for the four latest proficiency samples are shown in Table 9.

The average uncompacted voids contents for the samples tested in Table 9 ranged from 42.7% to 44.7%. The data in Table 9 indicates that AASHTO T304 is more variable in practice than reported in the test method. The Southeast Asphalt User/Producer Group conducted a round-robin for AASHTO T304 Methods A, B, and C. The study included seven aggregate sources from the southeastern United States: two natural sands, two granite sources, two limestone sources, and standard graded sand. The standard graded sand had been previously used to establish the precision statement for AASHTO T304. Sixteen laboratories participated in the study, although not all of the data were returned for all of the samples. The results indicated that Method C was more variable than Methods A and B, which had similar variability. For Method A, the single operator standard deviation was 0.57% voids and the multilaboratory standard deviation was 0.75% voids, which correspond to D2S limits of 1.61 and 2.12, respectively (72). The variability of the bulk dry specific gravity measurements (72) used in the calculations to determine the uncompacted void content significantly increases the test variability. The AMRL results and Southeast Asphalt User/Producer Group Study indicate that the AASHTO T304 precision statement may need to be revised.

2.4.6 Summary of Findings on Fine Aggregate Texture and Angularity

The findings on fine aggregate texture and angularity are as follows:

- The results of AASHTO T304 Methods A and B are highly correlated, with Method B producing larger uncompacted void contents. Tests using alternative gra-

dations other than Method A were also highly correlated to the Method A results and maintained the same ranking of fine aggregates. The results from AASHTO T304 Method C are affected by the fine aggregate gradation and are not recommended for comparing particle shape and texture.

- The current Superpave consensus aggregate properties do not address the angularity of the material that pass the No. 4 sieve but are retained on the No. 8 sieve. It is doubtful that the current AASHTO T304 apparatus could accommodate material of this size fraction.
- Numerous test procedures are available to assess fine aggregate texture and angularity. Several of the imaging techniques and the CAR test appear to be promising. Researchers using the DST (ASTM D3080) have indicated that it is difficult to obtain consistent results; however, to date, the majority of the work to correlate fine aggregate shape and texture to performance has been completed using AASHTO T304 Method A.
- The results of studies relating the uncompacted voids content from AASHTO T304 Method A to performance are mixed. Generally, studies indicated a trend between uncompacted voids content and improved rutting performance, but in some cases the trend was weak. Subtle differences in uncompacted voids content can be overwhelmed by the effect of the coarse aggregate or other HMA mixture properties. Several studies supported the 45% uncompacted voids criteria for high traffic, but several also indicated performance was unclear between 43% and 45% (or higher) uncompacted voids. There is clear evidence that good-performing mixes can be designed with uncompacted voids contents between 43% and 45%, but evaluation of these mixes using a rutting performance test is recommended.
- Higher uncompacted void contents generally resulted in higher VMA and lower densities at N_{initial} .
- The variability of AASHTO T304 method A appears to be larger than reported in the test method. Much of this variability appears to be related to variability in the fine aggregate specific gravity measurements used to calculate the uncompacted voids. Ongoing research to improve fine aggregate specific gravity measurements may also benefit AASHTO T304.

TABLE 9 AMRL AASHTO T304 proficiency sample results (71)

Sample Numbers	Number of Labs	Multilaboratory Precision				Single Operator Precision	
		First Sample		Second Sample		Std.	D2s
		Std.	D2S	Std.	D2s		
119 120	136	0.937	2.651	1.012	2.863	0.358	1.103
123 124	183	1.129	3.194	1.149	3.250	0.406	1.147
127 128	211	1.291	3.651	1.349	3.815	0.377	1.066
131 132	242	0.917	2.594	0.858	2.428	0.381	1.077

2.5 IMAGING METHODS FOR THE ASSESSMENT OF AGGREGATE SHAPE, ANGULARITY, AND TEXTURE

2.5.1 Introduction

The proceeding sections discussed some of the shortcomings of the indirect methods of measuring aggregate shape, angularity, and texture. For example, the uncompacted void tests for fine and coarse aggregate do not separate the effects of shape, angularity, and texture. Further, the indirect tests can be time consuming and are subject to testing variation based upon the experience of the technician. The sample size evaluated can be small in proportion to the quantity of material produced: for example, the percent F&E is only based on the shape of 100 particles of a given size fraction. The relatively poor precision statements for the uncompacted voids in fine aggregate (AASHTO T304) and F&E (ASTM D4791) demonstrate the magnitude of the test variability. By comparison, Maerz (73) outlines the advantages of digital systems:

- Reduced unit testing cost,
- Reduced technician subjectivity,
- Faster results, and
- Ability to test larger sample size to improve statistical validity.

These advantages are somewhat offset by additional capital costs for the equipment. Digital equipment may also be more complicated, requiring a greater degree of technician training. Finally, digital systems do not always provide measurements that are directly comparable to those of currently accepted techniques. For instance, there can be differences in gradations based on digital data as compared with wire-mesh sieves with square openings because F&E may fit through the sieve opening on the diagonal (e.g., a $1/2$ -in.-wide particle may fit through a $3/8$ -in. sieve).

Several researchers have evaluated digital imaging methods to measure aggregate shape, angularity, and texture. Some of these methods have been introduced previously where they have been used in performance studies in conjunction with the currently accepted methods. NCHRP is currently sponsoring Project 4-30A, "Test Methods for Characterizing Aggregate Shape, Texture, and Angularity." The objective of this research is to identify or develop test methods for both central and field laboratories to measure shape, angularity, and texture (74). These methods are to be applicable to HMA, hydraulic cement concrete, and unbound base materials. The following sections provide a brief overview of the major types of digital image or digital vision systems.

2.5.2 Video Imaging Systems

2.5.2.1 Early Imaging Systems

The first attempts to use digital imaging to quantify aggregate shape involved a photocopy machine and a digitizing

tablet (75). The technique was viable for particles larger than the No. 8 sieve. Aggregate particles were first placed in clear trays in a "flat" orientation such that their minimum dimension was orthogonal to the surface of the copier. A photocopy was then made of a group of 50 aggregates producing two dimensional images of each aggregate particle. The minimum (i.e., the third) dimension of the aggregates was then measured with a vernier caliper. Both the photocopied image and the thickness determined with the vernier caliper were digitized by means of a digitizing tablet. Measurements on aggregates smaller than the No. 8 sieve were made with micro-photographs. The minimum dimension of these particles was measured by evaporating a thin film of metal onto the slide and measuring the shadow of the particle. Once the images were digitized, the data could be manipulated to determine shape factors such as elongation ratio, flatness ratio, shape factor, or surface roughness (75).

A black-and-white charged couple device (CCD) camera coupled with an image analysis system replaced the use of digitizing tablets and photocopied images. Frost and Lai (76) captured static images using a Sony black-and-white camera and a Cambridge Instruments Quantiment Q570 Image Analysis System. Coarse aggregate particles were adhered to two pieces of Plexiglas joined at a 90° angle. The Plexiglas fixture was placed on a light box, which backlighted the sample to produce a high contrast between the particles and the background (77). Two dimensions were acquired: the longest dimension, d_L , and the intermediate dimension, d_I . The Plexiglas bracket was rotated 90° , and the shortest dimension, d_S , was captured. From this data, the ratio of the principal dimensions—elongation and flatness—could be calculated along with several other measures of shape (76).

Broyles et al. (78) used two black-and-white video cameras simultaneously to capture static images in three dimensions. Rows of aggregates were arranged on a stepped platform so that they could be viewed by two cameras at 90° to one another. Using this technique, the authors could complete 100 measurements of the principal dimensions of a particle in fewer than 10 min. This system could be used to calculate frequency distributions of flat or elongated particles for a range of ratios. In addition to shape parameters, analysis methods were developed for roughness and angularity (77).

2.5.2.2 VDG-40 Videograder

LCPC developed a videograding device designed to rapidly provide a gradation analysis of a large sample (Figure 6) (68). The device is commercially available. Prowell and Weingart (41) and Weingart and Prowell (79) investigated the use of the VDG-40 videograder for determining aggregate shape. As discussed previously, the device was primarily developed to measure aggregate grading of particles larger than 1 mm (No. 16 sieve), but it can also measure shape properties. A sample of the aggregate (up to approximately 50 lbs) is loaded into a hopper. A vibrating feed tray orients the aggregate particles such



Figure 6. VDG-40 Videograder.

that they lie flat (i.e., the longest and intermediate dimensions are visible). The aggregates fall off a rotating wheel; this prevents the aggregates from tumbling as they fall in front of the camera. Aggregates are backlit as they fall in front of a linear CCD camera, which produces a line-scan image of the aggregate. An ellipse having the same length and area as the image is fit to each particle. The device produces a sample gradation and two estimates of aggregate shape. The ratio of the length to the width of each particle is reported as the *SR*. The *SR* may be determined as a distribution or average. The flatness factor is a property for the group of aggregates tested related to the ratio of the average width to average thickness of the particles.

2.5.2.3 WipShape

The WipShape device, developed by Maerz (73, 80), uses two orthogonally mounted video cameras to capture aggregate images. The prototype used a vibrating feeder to produce approximately a 2-in. separation between aggregate particles on a black conveyor belt (80). The aggregate particles were lit from the side and above using two lamps. Problems were observed with the contrast between dark or mottled aggregates and the black feed belt (73). This led to the development of a final prototype with a circular rotating table (73). The table is translucent and allows backlighting of the aggregate particles. Images are captured at 60 frames/s using a pair of Sentech STC 1000 cameras. An Imaging Source DFG-BW1 digitization board captures the image from both cameras simultaneously. Custom software manages the data acquisition. “Thresholding” or the identification of the grayscale pixel value that separates the aggregate particle from the background, is accomplished automatically. The software fits a virtual “box” around the aggregate to determine the principal dimensions. The software determines aggregate size (grading), aspect ratio (elongation or flatness), and angularity. Angu-

larity is determined by analysis of the average radius of curvature of the particle (73).

2.5.2.4 University of Illinois Aggregate Image Analyzer

The University of Illinois Aggregate Image Analyzer (UI-AIA) is similar in concept to the first WipShape prototype. However, the UI-AIA, which is shown in Figure 7, uses three orthogonally mounted cameras: a top camera, side camera, and front camera. This allows an accurate determination of the volume of the particles, which in turn increases the accuracy of mass-based calculations such as gradation and percent F&E by mass because the volume and mass of the particle are related by the specific gravity (81). The aggregate particles are fed onto a conveyor belt moving at approximately 8 cm/s with 25 cm spacing between particles. One of two sensors triggers the cameras to capture the image in sequence using LabView software. An imaginary box is fitted to the captured images to determine the principal dimensions of a particle. Then, the volume of the box not occupied by the aggregate is subtracted from the volume of the virtual box to obtain the volume and, from that volume, the mass of the particle. An angularity index was also developed for the device to supplement coarse aggregate angularity measurements (ASTM D5821) (82).

2.5.2.5 Aggregate Imaging System

The preceding systems are primarily designed to evaluate coarse aggregate particles. The Aggregate Imaging System (AIMS) contains both a fine aggregate and a coarse aggregate module (83). These two modules allow the system to

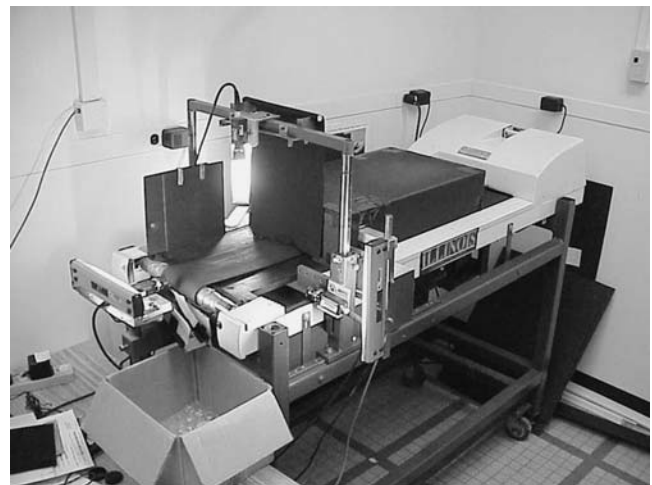

Figure 7. University of Illinois Aggregate Image Analyzer.

capture measurements of shape (form), angularity, and texture for both fine and coarse aggregates.

The system (Figure 8) consists of a video microscope, video camera, data acquisition system, lighting system, automated carriage, and associated software. The aggregate particles are randomly spread on a tray. An Optem Zoom 160 video microscope is coupled with an LC-150 black-and-white CCD video camera to acquire the images. The camera is mounted on a carriage system that allows 250 mm of movement in the X and Y axes and 50 mm of movement in the Z axis. The Z -axis assembly can be manually moved an additional 250 mm to switch from fine to coarse aggregate measurements. Fine aggregate measurements and coarse aggregate measurements of the longest and intermediate axis and information for coarse aggregate angularity are accomplished using backlighting of the aggregate tray. All other measurements are accomplished with top-lighting. The images are captured using a National Instruments PCI 1409 analog frame grabber. Image processing is conducted using LabView software (83).

Fine aggregate analysis is based on 2-D images. The fine aggregate images are acquired to produce a resolution such that each pixel is less than 1% of the average aggregate diameter (84). At this resolution, the field of view includes 6 to 10 particles. Coarse aggregate analysis is based on a combination of measurements. First, aggregates are backlit, and 2-D images are captured to determine the largest and intermediate dimensions as well as angularity. One aggregate particle is captured in each image. The resolution of the image is set such that the pixel size is less than 1.0% of the average aggregate diameter. The third dimension of the aggregate is acquired during a second measurement pass. During this pass, the aggregates are top lit. The camera first focuses on a point on the tray. Then, the Z -axis is moved up until the top of the aggregate is in focus. The travel of the Z -axis is the third dimension of the aggregate. Gray scale images for texture analysis are captured during this pass (84).



Figure 8. Aggregate imaging system.

2.5.2.6 Laser-Based Aggregate Scanning System

The Laser-Based Aggregate Scanning System (LASS) uses a laser line scanner mounted on a 2-D linear slide system and a data acquisition system to measure aggregate particles between 1.0 mm and 100 mm in three dimensions (Figure 9) (85). In the prototype laboratory version, aggregate particles are placed on a scanning platform. The laser scanner moves along the 1.5 m Y -axis on the overhead slide performing 25 scans/s. The X -axis scan width is 120 mm. The laser scanner projects a stripe on the scanning platform. The reflection of the laser stripe is captured by a CCD camera. Knowing the location of the laser source, the 3-D coordinates of the surface of the object can be calculated. LASS has been used to measure grading, shape, angularity, and texture (86).

2.5.3 Image Analysis

The systems described above represent a sampling of the systems currently available. Two of those systems, UI-AIA

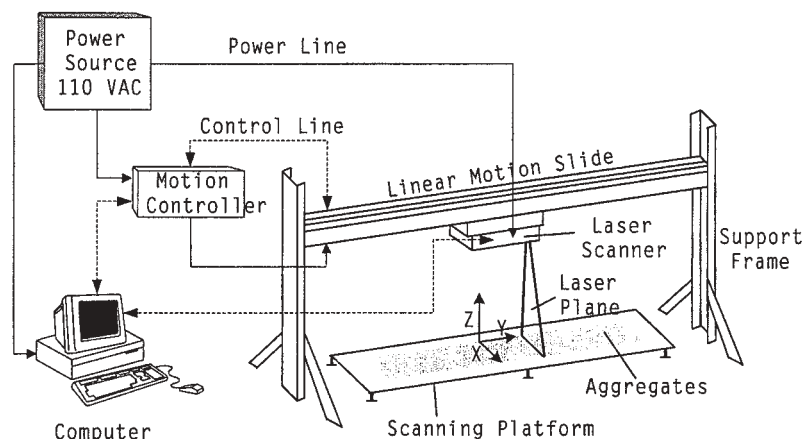

Figure 9. Laser-Based Aggregate Scanning System (85).

and AIMS, are under investigation as part of NCHRP Project 4-30. WipShape, UI-AIA, AIMS, and LASS can all measure the principal aggregate dimensions, length, width, and thickness of coarse aggregate. The VDG-40 Videograder can only measure two dimensions—length and width—and produce a global average of the third dimension. Image analysis techniques are used to extract information about grading, shape, angularity, and, in some cases, texture.

2.5.3.1 Aggregate Grading

The VDG-40 Videograder, WipShape, UI-AIA, AIMS, and LASS will all determine the size of the aggregate particles being evaluated. The aggregate size is used to categorize particle angularity and texture measurements by size. In its current form, only the VDG-40 is designed to test large aggregate samples, representative of a gradation sample. Weingart and Prowell (79) compared sieve results with the output of the VDG-40 for production samples of a No. 8 material. The material passing the 1.18-mm sieve was not evaluated. The results agreed well except for the 9.5-mm sieve. The developers of LASS also believe that their technology is adaptable to online measurements.

Problems can occur when comparing the results from digital imaging to wire mesh sieves. The size of an aggregate particle is generally taken to be the intermediate dimension (d_i) or the particle width. Some flat or elongated particles can fit through square sieve openings that are smaller than their width on the diagonal (73).

Rauch et al. (87, 88) completed a study to evaluate techniques to rapidly determine the gradation of unbound aggregates. Based on their review of potential technologies, digital image analysis, and laser scanning were recommended for further research. A continuation of the study evaluated five automated gradation devices: LCPC VDG-40 Videograder, W.S. Tyler Computer Particle Analyzer, Micrometrics Optisizer PSDA 5400, John B. Long Co. Video Imaging System, and Buffalo Wire Works Particle Size Distribution Analyzer. Two of the systems—the VDG-40 and the Computer Particle Analyzer—use line-scan cameras. These systems evaluate all of the particles (greater than a minimum size) that pass in front of the camera. The remaining three systems use matrix-scan technology. Matrix-scan devices typically sample 10% to 20% of the aggregate stream.

Five aggregate materials were used to prepare 15 test samples that were tested in each device. The samples were assembled to provide diverse shape, color, and texture. Based on the analysis of the results, the two-line scan devices are more repeatable; however, the results from the devices using line-scan technology do not compare as well with the benchmark sieve results (88). The Micrometrics Optisizer PSDA and John B. Long Co. Video Imaging System appear to provide the best overall results (88).

2.5.3.2 Aggregate Shape

Analyses of aggregate shape or form are generally aimed at replacing ASTM D4791, the F&E test. WipShape, UI-AIA, AIMS, and LASS all measure particles in three dimensions. From these measurements, the principal dimensions of a particle are determined.

The WipShape and UI-AIA systems both fit a virtual box around the aggregate particles to determine the longest, intermediate, and shortest dimensions (73, 81). Using these measurements, elongation is the ratio of the longest dimension to the intermediate dimension, and flatness is the ratio of the intermediate dimension to the smallest dimension. The Superpave method's specifications are based on the ratio of the longest to the smallest dimension or F&E as specified by ASTM D4791. Both WipShape and UI-AIA can produce frequency histograms of the percent of particles exceeding various ratios of elongation, flatness, or flatness and elongation.

Sphericity and form factor have been proposed as indexes of aggregate shape (76). Sphericity is described by Equation 2:

$$\Psi = \sqrt[3]{\frac{d_s \times d_l}{d_i^2}} \quad (2)$$

where

Ψ = sphericity,
 d_s = smallest dimension (thickness),
 d_i = intermediate dimension (width), and
 d_l = largest dimension (length).

Shape factor is described by Equation 3:

$$SF = \frac{d_s}{\sqrt{d_l \times d_i}} \quad (3)$$

where

SF = shape factor, and
 d_s , d_i and d_l are defined as for Equation 1.

Measures of aggregate shape using wavlets have been proposed for LASS and AIMS (83, 86, 89). Masad (83) states:

The fundamental idea behind wavlets is to decompose a signal or image at different resolutions. Wavlets are special functions, which satisfy certain mathematical conditions and are used in representing data, which could be one-dimensional signal (speech), or a two-dimensional signal (image).

2.5.3.3 Angularity and Texture

Several researchers have proposed methods of analyzing aggregate angularity and texture using fractals (55, 57, 90, and 91). Maerz (73) uses the minimum average curve radius

to estimate angularity using WipShape. Both AIMS and LASS use wavlets to describe angularity and texture (83, 86).

2.6 TESTS FOR AGGREGATE PROPERTIES RELATED TO MOISTURE DAMAGE

2.6.1 Introduction

Moisture is a key factor in the deterioration of asphalt pavement. Factors that influence moisture damage include aggregate, asphalt binder, type of mix, weather and environmental effects, and pavement subsurface drainage. The presence of plastic fines in the fine aggregate portion of HMA may induce stripping in the mix when exposed to water or moisture. The following test methods are used to evaluate the contribution of aggregate to moisture damage.

2.6.2 Sand Equivalent Test

The sand equivalent test is a consensus aggregate property specified in the Superpave mix-design method. The test was originally developed in 1952 as a rapid field test by Francis Hveem, whose original work suggested that low sand equivalents could indicate either clay or dust content. It is now used to determine the relative proportions of plastic fines or clay-like material in fine aggregates. Excessive clay-like particles may cause the asphalt binder to debond from the aggregate in the presence of moisture. Fine aggregate (passing the 4.75-mm [No. 4] sieve) is placed in a graduated, transparent cylinder that is filled with a mixture of water and a flocculating agent. After agitation and 20 min of settling, the sand separates from the clay-like fines and the heights of sand and sand plus clay are measured. The sand equivalent is the ratio of the height of the sand to the height of sand plus clay $\times 100$. Higher sand equivalent values indicate more sand and less clay and silt. Minimum specified sand equivalent values for fine aggregate in HMA range from 26 to 60 (92). The Superpave method specifies a minimum requirement of 40 to 50, depending on traffic.

This test has the advantages that it is quick to perform; requires very simple equipment, which can be used with minimal training or experience; and has given reasonably good results. However, there are some concerns about this test. In 1997, Stroup-Gardiner et al. (93) evaluated the sand equivalent test using 29 aggregates from a wide range of aggregate sources in Minnesota. Only 3 of 29 sand equivalent tests for individual stockpiles were less than 40%. The researchers found that sand equivalent test values were not sensitive to either the general mineralogy or the percentage passing the 0.075-mm sieve. There was no significant relationship between the sand equivalent test and mixture moisture sensitivity (tensile strength ratio test results) or VMA.

Alhozaimy (94) investigated the relationship between the sand equivalent and material finer than No. 200 sieve tests.

A total of 100 samples of natural silica sand and 100 samples of crushed sand were collected from the stockpiles of different ready-mixed concrete plants in Riyadh, Saudi Arabia. Also, the effects of silica and crushed sands—using different values of sand equivalents and passing a No. 200 sieve—on water demands of mortar were investigated. A strong correlation was found between the sand equivalent test and fine materials passing a No. 200 sieve for silica sand, whereas there was no correlation for the crushed sand. This indicates that the amount of fine materials in silica sand can be determined by either the No. 200 sieve or the sand equivalent test. However, the sand equivalent test can be misleading for crushed sand.

Kandhal et al. (95) conducted a study to determine the best aggregate test method that indicates the presence of detrimental plastic fines in the fine aggregate, which may induce stripping in HMA mixtures. Ten fine aggregates representing a wide range of mineralogical compositions and plasticity characteristics were used. Their plasticity characteristics were evaluated by three test methods: sand equivalent test, plasticity index, and methylene blue value. Ten HMA mixtures were made using a common limestone coarse aggregate, with these ten fine aggregates. AASHTO T283 (Resistance of Compacted Bituminous Mixture to Moisture Induced Damage) and a Hamburg wheel-tracking device were used to evaluate the stripping potential of the ten HMA mixtures. Statistical analysis of the aggregate test data and the mix validation test data showed that no significant relationship existed between sand equivalent test values and mixture validation tests results.

2.6.3 Plasticity Index

Plasticity index (PI) is being used by several agencies to measure the degree of plasticity of fines. PI is the difference between the liquid limit and the plastic limit of the material passing 425- μm (No. 40) sieve. ASTM D1073 (Standard Specification for Fine Aggregate in Bituminous Paving Mixtures) and D242 (Standard Specification for Mineral Filler for Bituminous Paving Mixtures) limit the PI of this fraction passing the 425- μm (No. 40) sieve (including the mineral filler) to a value of 4 or less. Some states specify a maximum PI for material passing the No. 200 sieve. A review of literature indicated no reported correlation between the PI and the field performance of HMA (95). Precision data have not been established for liquid limit and plastic limit tests, which are based on subjective judgment and experience of the tester.

2.6.4 Methylene Blue Test

The test method titled “Determination of Methylene Blue Adsorption Value of Mineral Aggregate Fillers and Fines” is recommended by the International Slurry Seal Association (ISSA) to quantify the amounts of harmful clays of the

smectite (montmorillinite) group, organic matter, and iron hydroxides present in fine aggregate (96). The principle of the test is to add quantities of a standard aqueous solution of the dye (methylene blue) to a sample until adsorption of the dye ceases.

A representative sample of dry fine aggregate is screened through the No. 200 sieve. The portion of the sample passing the No. 200 sieve is tested for methylene blue adsorption value (MBV). Ten grams of the sample are dispersed in 30 g of distilled water in a beaker. One gram of methylene blue (MB) is dissolved in enough distilled water to produce 200 ml of solution so that 1 ml of solution contains 5 mg of MB. This MB solution is titrated stepwise in 0.5 ml aliquotes from the burette into the continually stirred fine aggregate suspension. After each addition of MB solution and stirring for 1 min, a small drop of the aggregate suspension is removed with a glass rod and placed on a filter paper. Successive additions of MB solution are repeated until the end point is reached. Initially, a well-defined circle of MB-stained dust is formed and is surrounded with an outer ring, or corona, of clear water. The end point is reached when a permanent light blue coloration, or “halo,” is observed in this ring of clear water.

The MB value of a specific fine aggregate fraction is reported as milligrams of MB per gram of specific fine aggregate fraction, such as $MBV = 5.3 \text{ mg/g, 0/No. 200}$. The MBV expresses the quantity of MB required to cover the total surface of the clay fraction of the sample with a mono-molecular layer of the MB. Therefore, the MBV is proportional to the product of the clay content times the specific surface of the clay (97).

The MB test is simple and practical, and its cost is reasonable. Cross and Voth (98) used this test as a reference test for evaluating the APA’s suitability for predicting moisture susceptible mixtures. Kandhal et al. (95) found that the MB test is the fine aggregate test that is best related to stripping of HMA (compared with sand equivalent test and PI) and then recommended the MB test to be used to indicate the presence of detrimental plastic fines, which may induce stripping in HMA mixtures.

Aschenbrener and Zamora (99) evaluated several specialized aggregate tests and their relation to HMA performance. The tests include MB, Rigden voids index, stiffening power, and dust coating on aggregates. The evaluation was conducted using aggregate sources from 20 projects with known field performance. It has been found that the MB, dust coating on aggregates, and Rigden voids index, or stiffening power, when used with one another, accurately identified aggregate problems in the stripping pavements. The study indicated that the MB test, the other aggregate tests, or both can be used to isolate the potential problematic components of the HMA if an HMA fails a performance-related test, such as the Hamburg wheel-tracking device.

The MB test was also used by Harders and Noesler (100) to address different surface activities (i.e., surface energies).

The surface energy theory will be discussed in the following section.

Results from ongoing project NCHRP Project 4-19(2), “Validation of Performance-Related Tests of Aggregates for Use in Hot-Mix Asphalt Pavements,” showed a very significant relationship between the rutting performance of the wet pavements and the MBV (23). A high MBV may be associated with a high amount of harmful material or a more active clay mineral type.

2.6.5 Surface Free Energy Theory

The mechanism of moisture damage can be explained by the theories of adhesion. Four broad theories have been presented to explain adhesion of asphalt binder to aggregate: the mechanical theory, the chemical reaction theory, the surface free energy theory, and the molecular orientation theory. The surface energy theory is being used by several researchers in evaluating the moisture potential of asphalt mixtures (100–104). The surface energy theory primarily involves calculating the surface energies of the asphalt binder and the aggregate. The bonding energy between asphalt and aggregate can then be calculated either between the two components alone or in the presence of a third liquid such as water. Cheng et al. (101) stated that the bonding strengths helped to select the most compatible mixtures, to improve the adhesive bond, and to reduce debonding potential in the presence of moisture. Several methods have been developed to measure the surface energy of an asphalt-aggregate system. Elphinstone (102) measured the surface energies of various kinds of asphalts using the Wilhelmy Plate technique and measured the contact angle of many asphalt samples. Unfortunately, he could not obtain the surface energies for a number of samples with his technique because of errors in the contact angle measurements. Li (103) measured the surface energies of a variety of European aggregates. Cheng et al. (104) measured surface energies of some widely used aggregates and asphalt binders in the southern United States using the Universal Sorption Device (USD) and Wilhelmy Plate method, respectively. Later, Cheng et al. (105) developed the adhesion failure model. Comparison between mechanical test results (repeated load permanent deformation tests) and the adhesion failure model showed the same trends of moisture damage potential for the aggregates and asphalts evaluated. Although the surface energy theory is not new, methods to evaluate moisture damage potential based on this theory and testing protocols need additional study.

2.6.6 Net Adsorption Test

The net adsorption test (NAT) was applied to the HMA industry by the SHRP A-003B contractor to predict moisture damage (stripping) in asphalt-aggregate mixes (106). It was developed to determine the adsorptive nature and the water

sensitivity of a wide range of typical paving-quality aggregates. This relatively fast and simple test was developed to provide a rapid, simple, quantitative measure of the amount of asphalt adhered to aggregate after exposure to water. It was used to evaluate the affinity of asphalt for aggregate and to determine the water sensitivity of a given asphalt-aggregate pair. The test is composed of three parts. First, asphalt is flowed over and adsorbed onto aggregate from a toluene solution using a recirculating column. The adsorption step is allowed to run for 7 h. Second, a small amount of water is introduced into the toluene solution, and the adsorbed asphalt that is sensitive to the presence of water is desorbed from the aggregate. Third, the amount of asphalt remaining on the aggregate after the introduction of water is determined. This amount is termed “net adsorption”; it gives a measure of the “affinity” of the asphalt for the aggregate by water and serves as an indicator of the water sensitivity of the pair. The aggregate properties predominated in the test, showing a stronger influence than the asphalt on the initial amount of asphalt adsorbed, on the amount of asphalt desorbed by water, and on the amount of asphalt remaining—the net adsorption.

After the NAT was proposed, it was validated using both laboratory and field data by Hicks et al. (107) and Terrel et al. (108). Both research teams used two accelerating rutting tests: Oregon State University (OSU) wheel tracker and SWK/UN (SWK Pavement Engineering in Nottingham, UK) wheel tracker to evaluate water sensitivity in the validation of the NAT. The prediction of water sensitivity of the binder as proposed by the SHRP A-003B NAT shows little or no correlation to either these two wheel tracking tests or to the SHRP A-002 predications for permanent deformation. As a conclusion, the authors suggested that the NAT is a poor indicator of the moisture sensitivity of the binder.

Woodward’s research in his Ph.D. dissertation (109) showed the ability of NAT to rank aggregate-asphalt pairings. He stated that the NAT test was able to highlight how optimum levels could be achieved in terms of predicating performance; however, this result has not been validated by a wide range of aggregate resources.

2.6.7 Other Aggregate Tests Related to Moisture Damage

In addition to the NAT, the SHRP A-003B researchers developed two “specialty” tests (106). The limestone reactivity test is a quick and reliable method for determining the amount of active sites present on the aggregate surface. It can be used to differentiate among limestone sources. Another “specialty” test assesses the reactivity of the asphalt-aggregate systems to the addition of anti-stripping agents.

Woodward (109) used the Vialit Plate Test and the Instron Adhesion Pull-Off Test (INAPOT) along with the NET to predict the adhesion property in the laboratory. The INAPOT was developed as a method to quantify the effect of steady load and temperature conditions on the adhesive bond per-

formance of aggregate prisms pressed into a pot of bitumen (109). This test uses expensive test equipment and involves elaborate test sample preparation. The testing procedure consists of fixing a rectangular aggregate prism into the upper jaw of an Instron apparatus, pressing the prism into a layer of bitumen held in a container or pot, and extracting the prism from the bitumen under controlled conditions. The INAPOT requires that aggregate prisms be cut from lump rock samples representative of the aggregate being assessed because of the inability of the Instron jaws to grasp individual aggregate particles. Instead, prisms 18 mm × 10 mm × 30 mm were cut; the face to be assessed was left as a natural uncut surface. Woodward’s study (109) showed that the INAPOT was able to quantify the variation in tensile adhesion characteristics for three individual constituents from the same greywacke quarry. The results agreed with in-service experience that the poor initial coating, adhesion, and premature stripping aggregate gave the worst INAPOT results. His study also indicated that the influence on adhesion of different rock types was much less than that of temperature.

The French Vialit Plate test was originally developed in the early 1960s to simulate conditions experienced on-site with the use of chippings applied as surface dressing. Through his study, Woodward (109) concluded that this method offers the engineer a quick and simple means of predicting the in-service performance of aggregate used in surface courses under a wide range of simulated in-service conditions.

2.6.8 Summary of Aggregate Tests Related to Moisture Damage

This section gives the state of practice for test procedures used to evaluate aggregate moisture damage potential. Many factors influence moisture damage: HMA characteristics (aggregate, asphalt binder, and type of mixture); weather during construction; environmental effects after construction; and pavement surface drainage. Aggregate tests related to moisture damage generally fall into two categories: tests to identify clay-like fines and tests that evaluate the surface properties of the aggregate related to the adhesion of the binder to the aggregate.

The Superpave method currently specifies the Sand Equivalent Test (AASHTO T176) to identify clay-like fines. Controversial results and findings exist for the sand equivalent test, PI, NAT, and other tests. In some cases, the sand equivalent test identifies crusher fines as harmful clay-like particles. It appears that the MB test may be the best method to quantify the amount of harmful clays in fine aggregate.

The NAT was developed during SHRP to evaluate the interaction between the asphalt binder and aggregate in the presence of water; however, validation work conducted as part of SHRP indicated a poor predictive ability for the test, and it has not been widely used since. At the present time, the surface energy techniques appear to be promising. The procedures are relatively new. Results and efforts from NCHRP

Project 9-37, “Using Surface Energy Measurements to Select Materials for Asphalt Pavements,” can be used to apply the energy surface theory in the future.

2.7 TESTS RELATED TO AGGREGATE DURABILITY

Aggregate durability generally encompasses two categories of tests: tests that measure aggregate abrasion resistance and breakdown during handling, mixing, laydown, and under traffic and tests that address aggregate weathering when aggregate is exposed to freezing and thawing or wetting and drying. These tests are employed in concert to ascertain that the aggregate used in the production of HMA will be durable. Specifically, tests related to durability are selected to address the following:

- **Aggregate breakdown during handling, mixing, and placement.** Such breakdown can alter the HMA gradation, resulting in a mixture that does not meet volumetric properties. This breakdown can generally be accounted for in the design process.
- **Abrasion or weathering of the aggregates in the pavement structure.** Gross aggregate wear or weathering can occur in the form of raveling, popouts, or pot-holes. An example of extensive surface loss caused by popouts in a 2-year-old Superpave-designed pavement is shown in Figure 10.
- **Freeze-thaw durability**, which is more closely associated with the performance of aggregate base, Portland cement concrete, and surface treatments. This may be due to the fact that aggregate particles in HMA should be coated with asphalt. Popouts of surface aggregates may be related to freeze-thaw durability.
- **Other forms of abrasion on the pavement surface**, such as polishing or loss of microtexture of coarse aggregate particles. Polishing is beyond the scope of this report and will only be treated briefly.



Figure 10. Popouts and raveling in 2-year-old pavement.

Some western U.S. states and European countries use basalts containing high-plasticity expansive clay minerals.

2.7.1 Aggregate Tests Related to Abrasion Resistance and Breakdown

2.7.1.1 LA Abrasion

Aggregates must be resistant to crushing and abrasive wear to withstand handling during stockpiling, shipping, mixing at the HMA plant, laydown, and compaction. Once the HMA is in place, the aggregates need to be sufficiently hard or tough to transfer load through contact points. This is especially true of aggregates used in gap-graded mixtures such as SMA. Aggregates must also withstand surface abrasion and polishing from traffic.

The SHRP aggregate expert task group identified the Los Angeles Abrasion Test, AASHTO T96 (ASTM C131), as the fourth most important aggregate property in both the first- and second-round questionnaires used in the Delphi process (1). The LA abrasion test was included as a source property in the Superpave mix design system. The specification values for source properties were to be set by the agency to allow for variations in locally available aggregates. Based on the survey conducted as part of this study, 96% of the 48 U.S. states and Canadian provinces that responded use the LA abrasion test.

The LA abrasion test was originally developed by the Municipal Laboratory of the city of Los Angeles in the 1920s. The LA abrasion test procedure requires that an aggregate sample be placed inside a rotating steel drum containing a specified number of steel balls or charge. As the drum rotates, a shelf inside the drum picks up the aggregate and steel spheres. The shelf lifts the aggregate and steel balls around until they drop approximately 27 in. on the opposite side of the drum, subjecting the aggregate to impact and crushing. The aggregate is subjected to abrasion and grinding as the drum continues to rotate until the shelf picks up the contents, and the process is repeated. The drum is rotated for a specified number of revolutions, typically 500. Afterward, the aggregate is removed from the drum and sieved over a No. 12 (1.7-mm) sieve to determine the degradation as a percent loss.

Kandhal and Parker (2) conducted a literature review on the early LA abrasion research as part of NCHRP Project 4-19. Their review indicated only a fair correlation with field performance for coarse aggregates; however, they did note that early developmental studies, most notably by Woolf (110) and Melville (111), indicated good correlations with performance. Testing conducted as part of NCHRP Project 4-19 indicated that LA abrasion loss was not related to historical pavement performance ratings (112).

Limited recent research has been conducted on the LA abrasion test by Amir Khanian et al. (113). A survey conducted as part of the study indicated that the majority of state DOTs specified the LA abrasion test, similar to the current

study. The survey also determined that most agencies believed that the LA abrasion results were most related to breakdown during compaction and that the majority were satisfied with their current specifications. The study investigated the breakdown of four granite aggregates with LA abrasion values ranging from 28 to 55. The study evaluated indirect tensile strength, resilient modulus, and aggregate breakdown for samples compacted using 25, 50, 75, or 100 Marshall blows. The indirect tensile strength and resilient modulus tests were performed on both conditioned and unconditioned samples. The test results indicated that the indirect tensile strengths for the three mixtures produced with the granite having an LA abrasion loss greater than or equal to 30% were significantly lower for both the conditioned and unconditioned samples than the strengths produced with the aggregate having an LA abrasion loss of 28%. Further, the tensile strength and resilient modulus ratios were generally lower for the mixture produced with an aggregate having an LA abrasion loss of 55%. Interestingly, for the dense-graded mixes tested, aggregate breakdown was only significant on the 0.150 and 0.075 (No. 100 and No. 200) sieves. Unfortunately, the level of breakdown that occurs in the field was not investigated.

As previously discussed, work by Aho et al. (39) indicated the interrelationship between F&E, LA abrasion, and expected breakdown in the field. The LA abrasion of the sources in this study represented a very narrow range (24% to 26%). This study concluded that breakdown in the gyratory compactor generally exceeded the breakdown that occurred in the field for dense-graded mixtures used in Illinois. In conjunction with their FAA study, Roque et al. (51) recommended including LA abrasion limits to differentiate between good- and poor-performing fine aggregates with borderline FAA values.

Xie and Watson conducted a study to evaluate the breakdown of SMA mixtures during laboratory compaction (114). Five aggregate sources with a range of LA abrasion loss from 17% to 36% were selected for the study: crushed gravel, granite (two sources), limestone, and traprock. Aggregate sizes were combined to produce 9.5-mm, 12.5-mm, and 19.0-mm NMAS mixtures. Samples were compacted with either a 50-blow Marshall or 100-gyratory Superpave Gyratory Compactor (SGC) effort. Ignition furnace extractions were used to compare the batched, loose-mix, Marshall-compacted, and SGC-compacted gradations. Comparisons were made based on the critical or breakpoint sieve for the SMA mixtures. For the 12.5-mm and 19.0-mm NMAS mixtures, the 4.75-mm (No. 4) sieve was used; for the 9.5-mm NMAS mixtures the 2.36-mm (No. 8) sieve was used. As shown in Figure 11, the 50-blow Marshall compaction effort resulted in greater breakdown than the SGC compaction. The data from this study correlated well with similar data from NCHRP Project 9-8 (36). Unfortunately, this study was not correlated to the actual breakdown that occurred in the field. Breakdown for larger sieve size is expected with gap graded mixes such as SMA because there are more coarse aggregate contact points during compaction. Increased breakdown for open-graded mixtures was also noted in NCHRP Project 4-19 (2) when assessing dry aggregate breakdown in the SGC.

2.7.1.2 Other Tests Related to Aggregate Breakdown

In Europe, a number of alternative tests are used to assess aggregate breakdown: the Aggregate Impact Value Test (BS

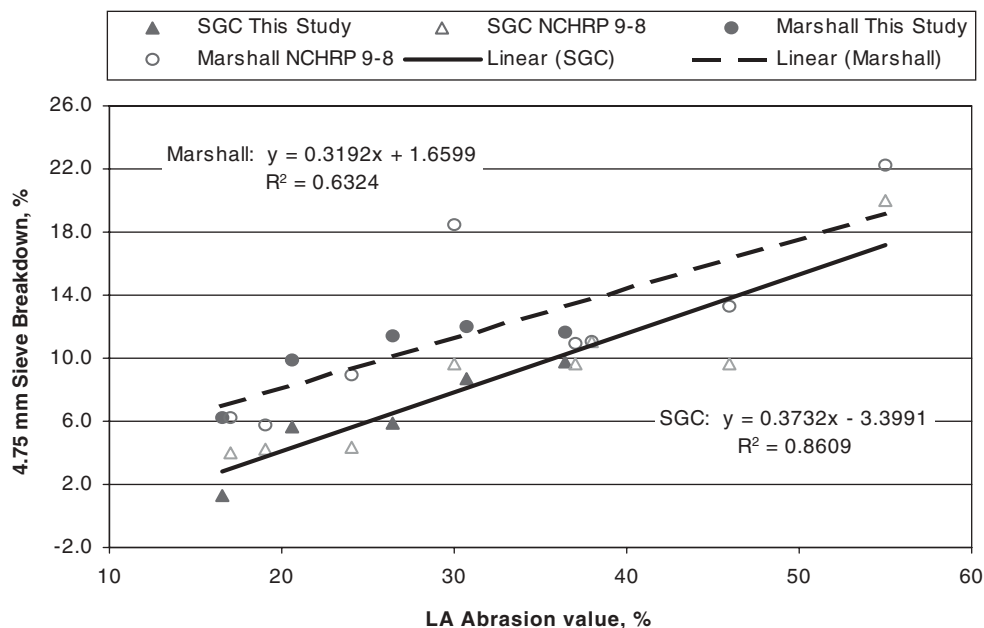

Figure 11. Critical sieve breakdown versus LA abrasion by compactor type (114).

812), the German Schlagversuch Impact Test (DIN 52115) and the Aggregate Crushing Value (BS 812). The aggregate impact value test uses a graded sample between 10.0 mm and 14.0 mm. The sample is subjected to 15 blows of a 100-mm (4-in.) diameter hammer weighing 13.5 to 14.0 kg that falls 380 ± 5 mm. The aggregate impact value is reported as the percentage of the initial sample weight passing the 2.36-mm (No. 8) sieve after impact. A lower value indicates a stronger aggregate. The German Schlagversuch impact test is similar to the British aggregate impact value test except that the equipment is more expensive and less portable (109).

The aggregate crushing value test applies a compressive load to an approximately 2-kg sample in a steel container. A total load of either 400 kN is applied to a 150-mm-diameter piston or 100 kN is applied to a 75-mm-diameter piston in a 10-min period. The aggregate crushing value is expressed as the percentage of fines passing the 2.36-mm (No. 8) sieve based on the original sample mass.

Woodward (109) notes that with the impact and crushing-type tests, if the sample consists of a blend of good- and poor-performing particles, the stronger particles can often carry the load masking the weaker particles. Conversely, with what Woodward describes as fragmentation tests like LA abrasion, weaker particles are equally exposed to fragmentation forces. Woodward (109) produced a correlation matrix among the aggregate impact value, German Schlagversuch impact, aggregate crushing value, and LA abrasion tests as shown in Table 10. The data in Table 10 is based on a range of aggregates commonly used in Great Britain and Ireland. There were 246 common aggregates tested with the aggregate impact value and aggregate crushing value tests, 75 to 91 common aggregates tested for LA abrasion, and 13 common aggregates tested with the German Schlagversuch Impact test. All of the relationships were statistically significant except the relationship between the LA abrasion test and the German Schlagversuch impact test. There appears to be a reasonable fit between LA abrasion and the aggregate crushing value tests. Senior and Rogers (115) also compared the results from the LA abrasion and aggregate impact value tests for use in Ontario. They found a correlation ($R = 0.797$) based on 98 aggregate sources. Senior and Rogers concluded that the aggregate impact value test could be a practical substitute for the LA abrasion test to assess the extent of breakdown expected during processing

and handling. The aggregate impact value test was stated to have the following advantages: it requires a small sample; it requires less expensive, portable equipment; and samples may be tested in a wet condition (115).

Kandhal and Parker (2) found better correlations between LA abrasion loss and both the aggregate impact value and the aggregate crushing value ($R = 0.932$ and 0.934 , respectively); however, no clear trends were noted between the results of the LA abrasion loss, aggregate impact value, or aggregate crushing value, and subjective field performance ratings.

Both the USACE and Superpave gyratory compactors have been investigated as means of simulating aggregate breakdown during construction and handling. Ruth and Tia (116) investigated the use of USACE Gyratory Testing Machine to simulate the breakdown that occurs in drum plants. Samples were tested with an initial angle of gyration of 3° , ram pressure of 690 kPa, and air roller pressure of 62 kPa. Samples were tested to either 25, 50, 100, or 200 revolutions. Initial results indicated that the majority of the breakdown (greater than 50%) occurred in the first 25 revolutions. Three aggregate sizes were tested: No. 67, No. 89, and screenings. Good correlations were observed between LA abrasion loss and the percent passing the No. 10 sieve from the Gyratory Testing Machine for the coarse aggregates ($R^2 = 0.893$ to 0.985). Relatively good correspondence was found between the breakdown of samples blended to meet actual HMA job mix formulas tested at 25 gyrations and the breakdown that occurred when the same gradings were processed dry (no asphalt cement) through a drum plant. Two key advantages were observed for the Gyratory Testing Machine procedure: the distribution of fines passing the No. 12 sieve is investigated and samples may be tested wet.

The use of the SGC to evaluate aggregate toughness was evaluated by Kandhal and Parker (2). AASHTO No. 8 stone and a limited number of AASHTO No. 57 stone sources were tested in the SGC. The actual number of gyrations used to simulate breakdown is not reported (2, 112). Aggregate breakdown was assessed in two ways: gradation change for a single sieve, such as the 4.75-mm (No. 4), or the sum of the gradation changes on all sieves before and after compaction. Kandhal and Parker concluded that the SGC can be used to differentiate between tough and weak aggregates (2). They also noted that breakdown is greater for open graded mixtures,

TABLE 10 Correlation (R) matrix for aggregate strength tests (109)

Test	Aggregate Impact Value	German Schlagversuch Impact	Aggregate Crushing Value	LA Abrasion
Aggregate Impact Value	1.0	0.607	0.822	0.731
German Schlagversuch Impact	1.0	1.0	0.683	0.403
Aggregate Crushing Value			1.0	0.861
LA Abrasion				1.0

which would tend to have more contact points. Comparisons between the degradation in the SGC and field performance indicated no obvious breakpoints or correlations (2).

2.7.1.3 Aggregate Tests Related to Abrasion Resistance

A number of studies have evaluated alternative tests to measure aggregate degradation and abrasion resistance. Senior and Rogers summarize some of the concerns with the LA abrasion test that led to the investigation of alternatives: "The Los Angeles test is not always appropriate because the steel balls impart a severe impact loading on the test sample, overshadowing interparticle abrasion, which is the predominant process in pavement subject to traffic stress" (115). Senior and Rogers note that some coarse grained granites and gneisses tend to be brittle resulting in high LA abrasion losses but adequate field performance. By contrast, some softer aggregates such as carbonates and shales will absorb the impact of the steel balls, resulting in acceptable performance. These types of "soft" aggregates tend to be susceptible to slaking and to particle degradation when wet. Woodward (109) emphasizes the concerns that road surfaces are frequently wet and that there can be a significant reduction in the wet strength of some aggregates. Samples cannot be tested wet in the LA abrasion machine because it would be difficult to remove the fines that would cake along the shelf and drum.

The micro-deval test has been proposed as an alternative to LA abrasion in North America (2). The micro-deval test was developed in France in the 1960s (115). To perform the micro-deval test on coarse aggregate, a 1500-g sample is first soaked in 2 liters of water for at least 1h. A 5-kg charge of 9.5-mm ($\frac{3}{8}$ -in.) diameter balls is placed in a jar along with the sample and the water it was soaked in. The jar is then rotated at 100 rpm for 2 h. The sample is then washed and oven dried. The micro-deval abrasion loss is the percent of material passing the 1.18-mm (No. 16) sieve expressed as a percentage of the original sample mass. A reference material is available for periodic calibration of the loss.

Senior and Rogers investigated alternative tests for assessing coarse aggregate toughness and durability in Ontario (115). The alternative tests included the unconfined freeze-thaw test for coarse aggregate, micro-deval abrasion test, aggregate impact value test, polished stone value test and aggregate abrasion value test. Results were compared with LA abrasion loss, magnesium sulfate soundness loss, and water absorption. The micro-deval test produced similar results to the sulfate soundness test ($R = 0.85$ for 106 samples) with greater precision (115). Parker and Kandhal (2) also reported a reasonable correlation between magnesium sulfate soundness loss and micro-deval loss ($R = 0.848$, $p = 0.0001$). The improved precision is indicated by comparing the single operator standard deviations as a function of test value shown in Figure 12. Senior and Rogers recommended the micro-deval test, polished stone value, and unconfined freezing and

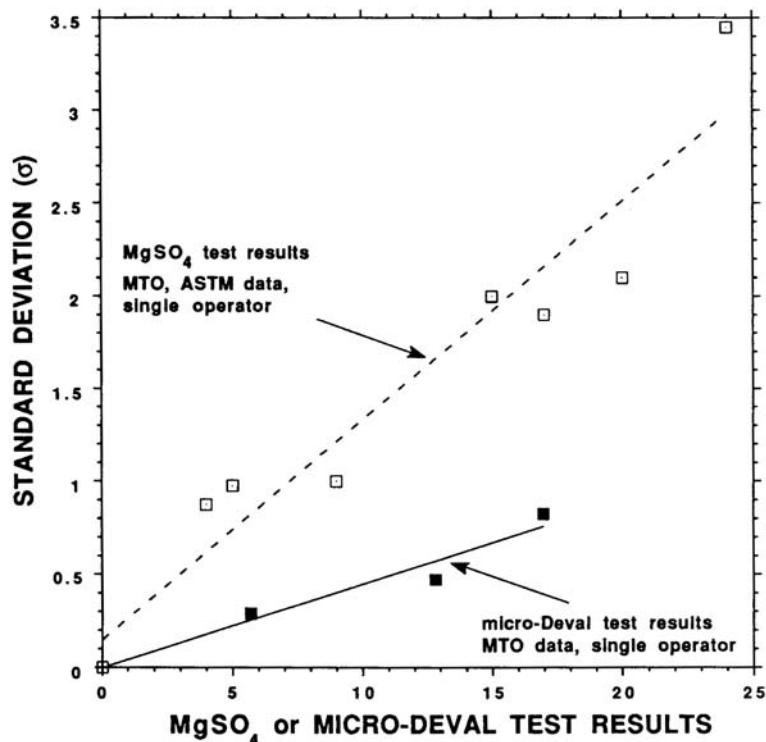

Figure 12. Standard deviation versus magnesium sulfate soundness or micro-deval abrasion (115).

thawing in concert to ascertain the performance of aggregates for HMA (115). Recommendations for modifications to the micro-deval test were developed for testing fine aggregates (117). The goal of these modifications was to replace the sulfate soundness test. Modifications included a smaller sample (500 g), small charge (1250 g), less water (750 ml), and a shorter test time (15 min). Loss was reported as the percent passing the 0.075-mm (No. 200) sieve. Based on the results of this study, micro-deval losses of less than 20 and 25 were established for high-quality and lower-quality HMA surfaces, respectively (109).

Woodward compared the abrasion results from the micro-deval test and aggregate abrasion value test (109). In the aggregate abrasion value test (BS 812), aggregate particles are held in a mold and the exposed aggregate is placed on a flat, rotating steel plate. A standard weight is placed on the mold, and silica sand is metered onto the steel plate. The test is generally performed dry. The aggregate abrasion value is based on the loss determined from the sample mass before and after abrasion normalized for the density of the aggregates. Based on testing of 133 samples, Woodward indicated a significant correlation ($R = 0.799$) between the aggregate abrasion value and micro-deval loss. Senior and Rogers did

not report the correlation between aggregate abrasion value and micro-deval. However, based on the figure in Senior and Rogers (115), the relationship appears reasonable. Senior and Rogers (115) recommend the micro-deval test over the aggregate abrasion value because the micro-deval test is less expensive and less time consuming.

NCHRP Project 4-19 recommended both the micro-deval test and magnesium sulfate soundness as the two tests most related to HMA performance in terms of popouts, raveling, and potholing (2). This recommendation was based on single variable correlations between both test results and subjective field performance rankings. Figures 13 and 14 indicate the relationships, respectively, between both micro-deval loss and magnesium sulfate soundness and field performance. An 18% maximum loss was recommended for both test methods. The correlation between micro-deval loss and magnesium sulfate soundness was not addressed in NCHRP Project 4-19.

Based on the recommendations from NCHRP Project 4-19, Cooley et al. (118) evaluated the micro-deval loss, LA abrasion loss, and sodium sulfate soundness of 72 aggregate sources from the southeastern United States. No statistically significant results were found between either LA abrasion or sodium sulfate soundness and micro-deval loss. Of the 72

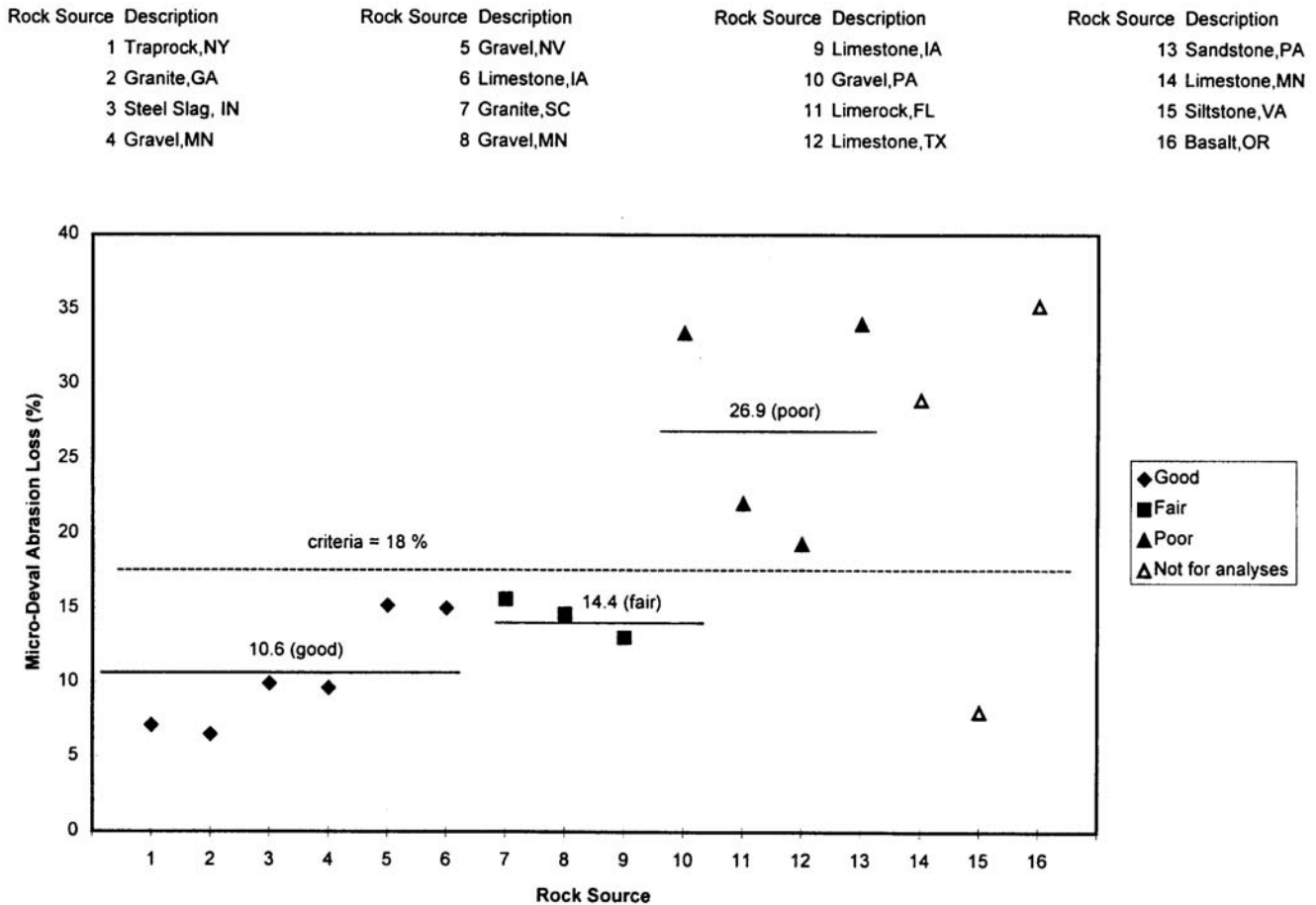

Figure 13. Pavement performance and micro-deval abrasion loss (2).

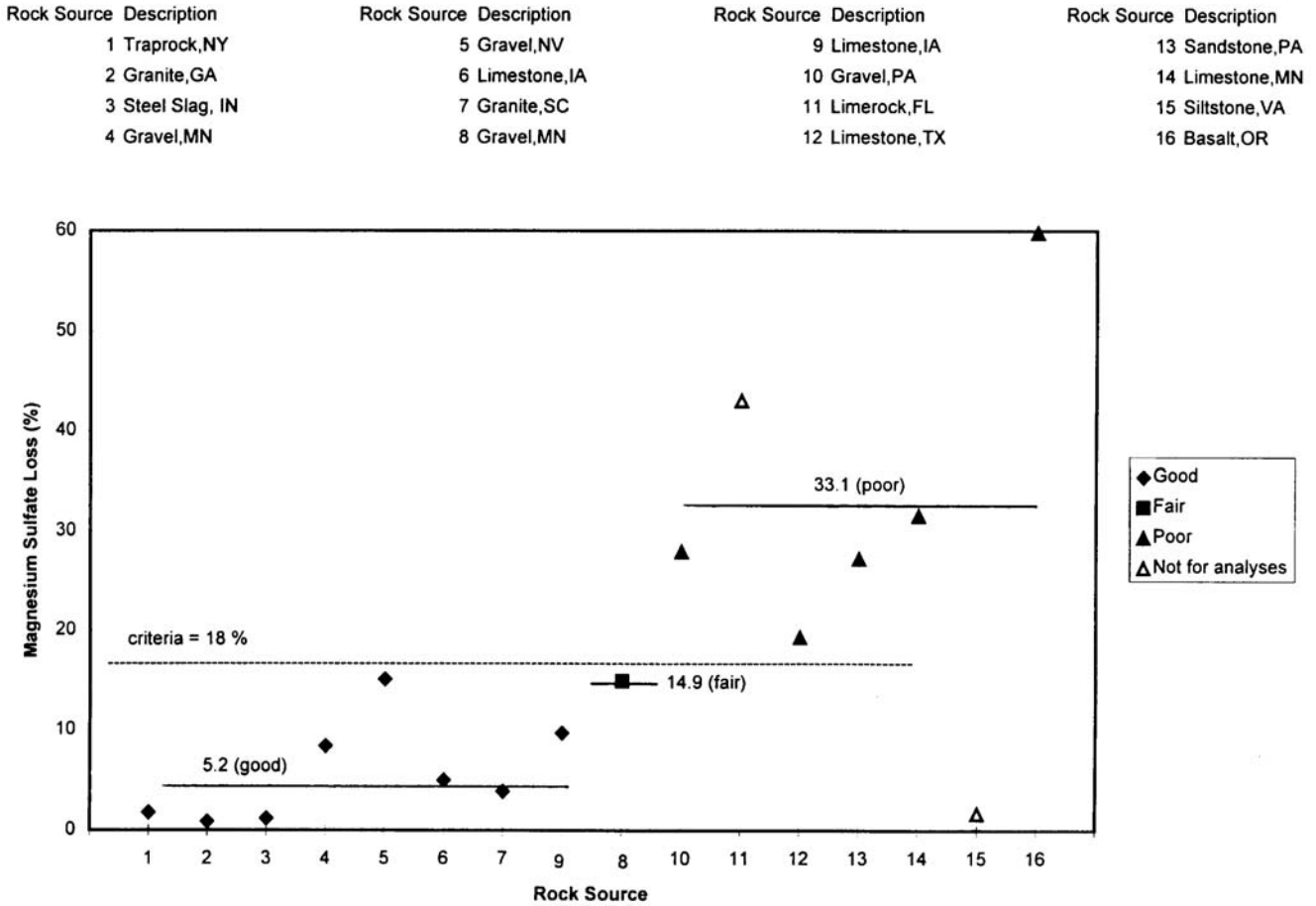

Figure 14. Pavement performance and magnesium soundness loss (2).

sources studied, six were characterized as poor performers. Two of these six aggregates produced micro-deval losses less than 6%. Also, 33% of the aggregate sources characterized as fair exceeded the 18% micro-deval loss criterion recommended by NCHRP Project 4-19 (118). The authors recommend consideration of specifications for micro-deval loss based on parent aggregate type. Woodward (109) also recommended specifications based on rock type. Ontario has implemented a specification for micro-deval loss based on aggregate type (119). For high-volume roads, the maximum micro-deval loss for igneous gravel is 5%; for dolomitic sandstone, 15%; for traprock, Diabase, and andesite, 10%; and for meta-arkose, meta-gabbro, and gneiss, 15%.

Rismantojo (23) tested six aggregate sources for micro-deval loss, LA abrasion loss, and magnesium sulfate soundness as part of NCHRP Project 4-19(2). Figure 15 shows the relationship between the micro-deval value and magnesium sulfate soundness loss for 22 aggregates representing the combined results from NCHRP Projects 4-19 and 4-19(2). Figure 15 indicates a good correlation ($R^2 = 0.76$) between the two tests. This matches a similar finding by Senior and Rogers (115). In theory, the two tests should indicate differing modes of deterioration. Woodward suggests that the

micro-deval test represents inter-particle abrasion within the HMA (109). Sulfate soundness tests are meant to represent the degradation that may occur because of freezing and thawing; however, several studies representing a large range of aggregate types have indicated that the tests are strongly correlated. Therefore, as proposed by Senior and Rogers (115), it appears advisable that only one such test be used to screen aggregates. Rismantojo (23) also indicated correlations between the micro-deval loss and both LA abrasion loss and water absorption. The relationship with LA abrasion broke down when the NCHRP Project 4-19 and 4-19(2) data sets were combined. The strength of some of the aggregates tested as part of NCHRP Project 4-19 appear to be greatly affected by water.

Eighteen aggregate sources in Oklahoma were evaluated by Tarefder et al. (120) to develop a baseline specification for micro-deval loss. The aggregates tested were predominantly limestone and sandstone. LA abrasion loss, freeze-thaw soundness, water absorption, and aggregate durability index were also performed. A fair correlation ($R^2 = 0.63$) was indicated between micro-deval loss and LA abrasion loss. The authors noted that different micro-deval abrasion loss values may be required, depending on the parent aggregate

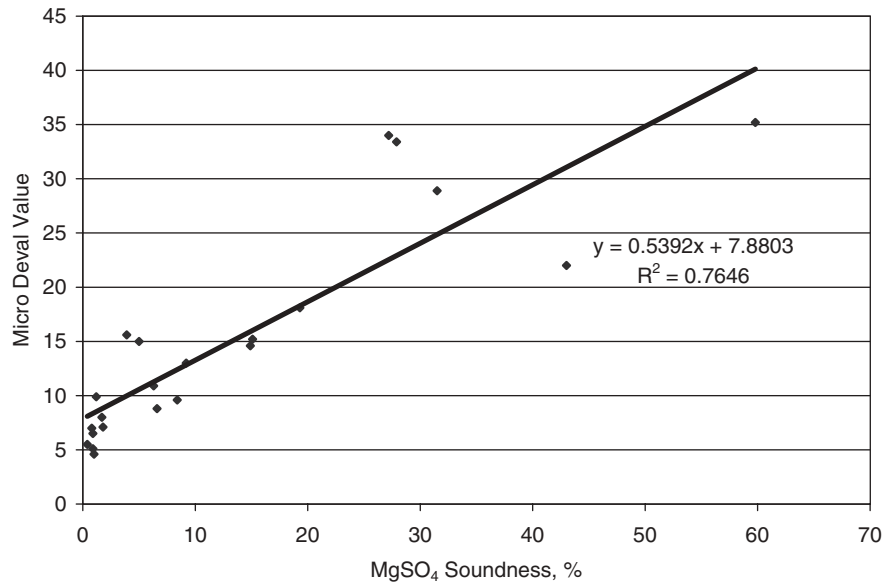

Figure 15. Relationship between magnesium sulfate soundness and micro-deval loss (2, 23).

type. A micro-deval abrasion loss of 25% was proposed for Oklahoma.

2.7.2 Aggregate Tests Related to Weathering and Freeze-Thaw Durability

There is some question as to whether aggregates used in HMA need to be resistant to freezing and thawing. Soundness tests such as magnesium or sodium sulfate soundness have commonly been used to assess degradation from freezing and thawing as well as from wetting and drying. Sulfate soundness tests were developed in the early 19th century to simulate the expansion of water within stone that resulted from freezing and thawing water (117). However, it has previously been shown that the magnesium sulfate soundness test is correlated with micro-deval loss. This may indicate that the magnesium soundness test better simulates the slaking caused by wetting and drying rather than freeze-thaw deterioration.

To perform the sulfate soundness test (AASHTO T104), a graded sample of coarse aggregate is prepared based on the NMA of the aggregate being tested. A graded fine aggregate sample is prepared with at least 100 g of material retained on each of the 4.75-mm, 2.36-mm, 1.18-mm, 0.600-mm, and 0.300-mm sieves. The sample is soaked in a saturated solution of sodium or magnesium sulfate for 16 to 18 h. The samples are then briefly drained and dried in a 110°C oven to a constant mass. Upon rewetting, the sulfate crystals expand in the aggregate pores, simulating the expansion of water upon freezing. The cycle of wetting and drying is typically repeated five times. After the final cycle, the sample is rinsed to remove the sulfate solution and dried at 110°C to a constant mass.

The sample is then sieved by hand over a smaller sieve appropriate for the size fraction. For 9.5-mm to 19.0-mm aggregates, the sample is sieved over an 8-mm (⁵/₁₆-in.) sieve. The weighted average percent passing the smaller sieve sizes expressed as a percentage of the original sample weight is the sulfate soundness loss. As discussed previously, there is a reasonable correlation between magnesium sulfate soundness and micro-deval loss. The relationship is fair to poor for sodium sulfate soundness (2, 118).

Currently, equipment is available to perform actual freeze-thaw testing. AASHTO T103, “Soundness of Aggregates by Freezing and Thawing,” describes three procedures to conduct freeze-thaw testing. A sample is initially washed and dried to a constant mass, after which it is sieved into size fractions. The three procedures for immersion and freezing are summarized in Table 11. The ethyl alcohol used in Procedure B is to aid the penetration of water. After the final cycle of freezing and thawing, the samples are dried to a constant mass and are sieved. The resulting weighted average loss for each size fraction is the soundness loss. Iowa, Ontario, and Michigan currently use test methods for freeze-thaw testing.

Senior and Rogers (115) investigated the use of the unconfined freeze-thaw test that is similar to AASHTO T103 for coarse aggregates. Individual size fractions retained on the 13.2-mm, 9.5-mm, and 4.75-mm sieves are placed in separate 1-liter jars. The samples are soaked for 24 h in a 3% NaCl solution. The samples are drained and sealed, frozen for 16 h, and then thawed at room temperature for 8 h. The freezing-and-thawing cycle is repeated five times after which the samples are dried and sieved similar to AASHTO T103. Testing by Senior and Rogers (115) suggests that the Ontario Unconfined Freeze-Thaw test is “to be preferred because it shows

TABLE 11 AASHTO T103 Procedures A, B, and C

Procedure	Solution	Immersion	Number of Cycles
A	Water	24 hours	50
B	0.5% solution of ethyl alcohol and water	Vacuum Saturation (25.4 mm Mercury)	16
C	Water	Vacuum Saturation (25.4 mm Mercury)	25

better discrimination than the sulfate test and is more precise.” Freeze-thaw losses of less than 6% for high-volume roads and of less than 30% for low-volume roads are recommended.

2.7.3 Aggregate Properties Related to Polishing and Frictional Resistance

The friction of a pavement surface is a function of the surface textures that include the wavelength ranges described by microtexture and macrotexture. Microtexture provides a gritty surface to penetrate thin water films and produce good frictional resistance between the tire and the pavement. Macrotexture provides drainage channels for water expulsion between the tire and the pavement, thus allowing better tire contact with the pavement to improve frictional resistance and to prevent hydroplaning. Initial macrotexture is a function of gradation, although tests for abrasion resistance—such as the aggregate abrasion value and micro-deval abrasion loss—are related to the change in macrotexture with time (119).

Polishing is the loss of microtexture with traffic wear. Polishing is common in many carbonate aggregates. No test methods were included in the Superpave mix design system to assess aggregate polishing. Agencies with aggregate sources prone to polishing have developed a number of means for qualifying or grading aggregate sources for various traffic levels. Polish Stone Value (BS 812) may be the most widely used test. Coarse aggregate particles having certain dimensions are first cemented into a curved mold. A group of the curved molds are attached to the outside of a steel wheel. The steel wheel rotates bringing the samples into contact with a rubber wheel treated with coarse and then with fine emery powders, which abrade the aggregate samples. Water is continually applied to the aggregate surface. Upon completion of the polishing, the mold with cemented aggregate particles is mounted on a British Pendulum Tester. A pendulum arm with an attached rubber pad swings across the mold so that the rubber pad drags across the samples. A scale measures the height of the pendulum swing after contact with the sample. Lower numbers represent greater microtexture.

Some aggregates are resistant to polishing. Other aggregate types maintain their microtexture by the continual abrasion of mineral grains exposing fresh nonpolished grains. This renewal is desirable as long as the loss is not so great as to represent an aggregate that is not durable. Senior and Rogers (115) recommend polish stone values in excess of 50

for high-volume roadways. Woodward (109), who has performed extensive skid testing, notes a quandary for British aggregate sources between desirable levels of polish stone value to maintain adequate skid resistance and desirable levels of micro-deval loss to ensure durability against raveling and popouts.

2.7.4 Summary of Tests Related to Aggregate Durability

The following is a summary of the tests related to aggregate durability.

- **Aggregates are subject to breakdown during stock-piling, mixing and compaction.** Excessive aggregate breakdown can alter in-place gradations and can affect the volumetric properties of the HMA. In the United States, the LA abrasion test (AASHTO T96) is the most commonly used test to assess aggregate breakdown during construction. It is correlated to other tests for aggregate breakdown. There is no evidence to suggest that the LA abrasion test should be replaced by another impact test for the purpose of assessing aggregate breakdown during construction.
- **Aggregates in HMA are subject to weathering and abrasion in situ.** Although originally intended to assess degradation from freezing and thawing, sulfate soundness tests (AASHTO T104) have been widely used to assess aggregates' resistance to weathering. Several studies indicated good correlation between magnesium sulfate soundness loss and micro-deval abrasion loss (AASHTO TP58). Several studies have also indicated that the strength of some aggregates is significantly lower when wet. The micro-deval test offers improved precision over sulfate soundness. The micro-deval test also indicates abrasion resistance. This suggests that the micro-deval test may be more suitable to predicting aggregates performance in relation to weathering and abrasion than is sulfate soundness. However, data suggests specifications for micro-deval loss may have to be based on aggregate type.
- **There is debate as to whether aggregates used in HMA need to be resistant to freezing and thawing.** Historically, sulfate soundness tests have been used to assess aggregates ability to resist weathering. A limited

number of states and provinces have adopted freezing and thawing tests similar to AASHTO T103. Where freezing-and-thawing is a concern, a test that actually reproduces freezing and thawing may be preferable over a sulfate soundness test.

- **Aggregate polish resistance is of concern to agencies with a predominance of carbonate aggregates.** The polish stone value test is the most widely used test to assess polish resistance of aggregates. When setting specifications, agencies need to consider the interaction between tests for abrasion resistance and durability—such as the micro-deval test and tests for polishing—because some aggregates with high polish stone values may not be durable.

2.8 EFFECT OF AGGREGATE GRADING ON HMA PROPERTIES

Gradation is perhaps the most important property of an aggregate. The link between aggregate gradation and asphalt mixture performance was recognized early in the development of mix design methods (121). Gradation affects almost all the important properties of HMA, including stiffness, stability, durability, permeability, workability, fatigue resistance, frictional resistance, and resistance to moisture damage. The mixture volumetric properties including asphalt content, VMA, and VFA have been identified as important parameters for durability and performance. However, the VMA is considered the most important parameter and is used in the Superpave mixture design specifications to eliminate use of potentially poor-performing mixtures.

2.8.1 Methods for Analyzing Gradations

Prior to the establishment of formal mixture design methods, gradation was evaluated to determine asphalt demand. Formulas were applied to the gradation, and asphalt requirements were calculated to provide satisfactory durability with minimum amount of asphalt binder (121). By the 1920s, the Hubbard–Field method of mix design recognized the importance of air voids as a key parameter controlling field performance of mixtures (122). The Hubbard–Field mix design is based on the need for air voids and for a minimum amount of asphalt binder. Voids in total mix and voids in aggregate mass were both specified. Early mixture design methods were based on a belief that a “gradation law” existed that controlled asphalt mixture properties. Considerable research effort was expended to discover this law that controlled aggregate packing. Associated with the gradation law was the belief that an “ideal” gradation existed that would provide adequate space for minimum amount of asphalt and air voids and adequate stability under traffic.

Today, aggregate gradations are commonly evaluated using a “0.45 power chart” (123). Despite the chart’s usefulness,

some confusion exists regarding its practical application. One use of the 0.45 power chart is to estimate available VMA of compacted mixtures. Increased VMA is obtained by moving further from the maximum density line, but several methods exist for drawing maximum density lines.

The packing characteristics of coated aggregate particles in an asphalt mixture are related to aggregate surface characteristics and gradation. Aggregate surface characteristics of the particles include angularity and surface texture. Gradation is the size distribution of the particles. When selecting aggregate for a project, surface characteristics may not be selected to obtain VMA. Conversely, VMA of a mixture is essentially obtained by default. If additional VMA is required, changes are usually made to the aggregate gradation. In some cases, natural sands, which are predominantly $-600\mu\text{m}$ sieve material, are added.

Natural sands have been identified as a cause of decreased resistance to permanent deformation and of tender mix problems during construction (121). As a result, limits have been placed on sand content and increases in VMA must be achieved by overall adjustment of gradation. Unlike natural sand addition, gradation adjustment can sometimes produce confusing results. Moving away from the maximum density line sometimes causes decreases rather than increases in VMA.

In the recent years, the Bailey method was developed to select aggregate gradations for HMA mixture design. The Bailey method was originally developed by the Illinois DOT and has become a systematic approach to aggregate blending that is applicable to all dense-graded asphalt mixtures, regardless of the maximum size aggregate in the mixture (124–126). The Bailey method uses two principles that are the basis of the relationship between aggregate gradation and mixture volumetrics: aggregate packing and definition of coarse and fine aggregate.

In the Bailey method, aggregate interlock is selected as a design input. Gradation selection considers the packing characteristics of aggregates. The parameters in the method are related directly to VMA, air voids, and compaction properties. The definition of “coarse” and “fine” is more specific in order to determine the packing and aggregate interlock provided by the combination of aggregates in various sized mixtures:

- *Coarse Aggregate:* Large aggregate particles that when placed in a unit volume create voids.
- *Fine Aggregate:* Aggregate particles that can fill the voids created by the coarse aggregate in the mixture.

The primary steps in the Bailey Method are (1) compare aggregates by volume and (2) analyze the combined blend. Aggregate is blended by volume. The combined blend is broken down into three distinct portions: coarse aggregate, coarse portion of fine aggregate, and fine portion of fine aggregate. Each portion is evaluated individually. Figure 16 shows a schematic of how the gradation is divided into the three portions. A factor of 0.22 was used to determine a primary con-

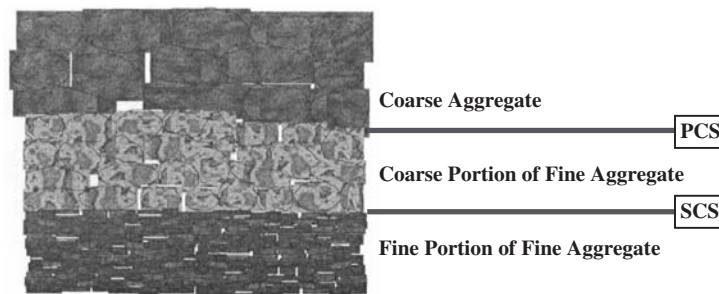

Figure 16. Overview of the divisions in a continuous gradation that allows an analysis of gradation (124).

trol sieve (PCS), secondary control sieve (SCS), and tertiary control sieve (TCS). Table 12 lists the control sieves for various asphalt mixture sizes.

The design and analysis of an aggregate blend using the Bailey method of gradation selection is built on four parameters:

1. Chosen unit weight, which describes the interlock of the coarse aggregate;
2. CA Ratio: coarse aggregate ratio, which describes gradation of coarse aggregate;
3. FA_c Ratio: fine aggregate coarse ratio, which describes gradation of coarse portion of fine aggregate; and
4. FA_f Ratio: fine aggregate fine ratio, which describes gradation of fine portion of fine aggregate.

Changes to any of these parameters will affect the air voids, VMA, constructability, and performance of the resulting asphalt mixture. These changes are the same whether the change is made in the laboratory during design or in the field during construction.

2.8.2 Effect of the Restricted Zone on HMA Performance

During SHRP asphalt research, an Aggregate Expert Task Group (ETG) was formed to develop recommendations for aggregate properties and gradations for HMA. The final recommendations for gradations included a restricted zone that lies along the maximum density line between the intermediate

sieve size (2.36-mm or 4.75-mm, depending on the maximum aggregate size) and the 0.3-mm size. The restricted zone was recommended to reduce the incidence of tender or rut-prone mixes. The origin of the Superpave-defined restricted zone is documented in a SHRP report (1, 127).

From a historical perspective, the restricted zone is something new: not until the Superpave method was there a formal guideline for aggregate gradation called the “restricted zone.” However, the industry has been aware of potential performance problems with gradations that pass through the Superpave-defined restricted zone-region. In 1940, Hveem (128) described a number of HMA gradations that showed a hump between the 0.6-mm and 0.15-mm sieve sizes. Hveem indicated that the hump was caused by an excessive amount of sand in this size fraction. He said that the hump is indicative of wind blown sand (smooth-textured, rounded sand) within the aggregate blend and that in his experience, the hump resulted in HMA mixes with low stability.

The initial concept of a restricted zone around the maximum density line can probably be indirectly traced back to Goode and Lufsey (123). Based upon work by Nijboer (129) to identify a maximum density line, Goode and Lufsey presented a 0.45 power grading chart for plotting aggregate gradations. To utilize the newly developed gradation chart, Goode and Lufsey evaluated 24 gradations to observe the effect of sand content on the stability of HMA mixes. What prompted their study were reported cases in which tender mixes were encountered with gradation humps between the 0.6-mm and 0.3-mm sieve sizes. Goode and Lufsey found that, in general, gradations that

TABLE 12 Control sieves for various asphalt mixes

NMAS, mm	37.5	25.0	19.0	12.5	9.5	4.75
Half Sieve	19.0	12.5	9.5	**	4.75	2.36
PCS	9.5	4.75	4.75	2.36	2.36	1.18
SCS	2.36	1.18	1.18	0.60	0.60	0.30
TCS 0.60	0.60	0.30	0.30	0.150	0.150	0.075

** The nearest “typical” half sieve for a 12.5-mm NMAS mixture is the 4.75 mm; however, the 6.25-mm sieve actually serves as the breakpoint. Interpolating the percent passing value for the 6.25-mm sieve for use in the coarse aggregate ratio will provide a more representative ratio value.

show appreciable humps above the maximum density line at about the 0.6-mm sieve produced higher VMA and lower Marshall stabilities than do gradations that plot as a more dense gradation.

The recently published *Transportation Research Circular E-C043: Significance of Restricted Zone in Superpave Aggregate Gradation Specification (130)* reviewed results from research relevant to the performance of mixtures with gradations passing above the restricted zone, below the restricted zone, cross the restricted zone or S-curve, and through the restricted zone. Independent results from the literature indicate that no relationship exists between the Superpave restricted zone and HMA rutting or fatigue performance. Mixes meeting Superpave and FAA requirements with gradations that violated the restricted zone performed similarly to or better than the mixes having gradations passing outside the restricted zone. Results from numerous studies (3, 127, 131–140) show that the restricted zone is redundant in all conditions when all other relevant Superpave volumetric mix and FAA requirements are satisfied. Based on this research, the restricted zone is no longer included in AASHTO M323 (Superpave Method).

2.9 EFFECT OF AGGREGATE FINES AND FILLERS ON HMA PERFORMANCE

Mineral fillers were originally added to dense-graded HMA paving mixtures to fill the voids in the aggregate skeleton and to reduce the voids in the mixture. When asphalt binder is mixed with aggregate, the fines mix with the asphalt binder to form a fines-asphalt mortar. The additions of fines to the asphalt binder can have three main effects: extend the asphalt binder, or stiffen the asphalt binder, or both. This modification to the binder that may take place because of the addition of fines could, in turn, affect HMA properties.

2.9.1 Research on Fines and Fillers

Extensive research efforts on mineral filler and baghouse fines have been made by many researchers throughout the world. Kandhal and Parker (2) and Kandhal (141) summarized the influences mineral filler can have on the performance of HMA mixtures as follows:

- **Depending on the particle size, fines can act as a filler or an extender of asphalt cement binder.** In the later case, an over-rich HMA mix can lead to flushing and rutting. In many cases, the amount of asphalt cement used must be reduced to prevent a loss of stability or pavement bleeding.
- **Some fines have a considerable effect on the asphalt cement,** making it act as a much stiffer grade of asphalt cement compared with the neat asphalt cement grade and, thus, affecting the HMA pavement performance including its fracture behavior.
- **Some fines make HMA mixtures susceptible to moisture-induced damage.** Water sensitivity of one source of slag baghouse fines has been reported in the United States, and the water sensitivity of other stone dusts has been reported in Germany. Stripping of HMA mixtures as related to the properties of filler–asphalt combinations has been reported in Japan.

In NCHRP Project 4-19, “Aggregate Tests Related to Performance of Asphalt Concrete in Pavements,” Kandhal and Parker (2) conducted dynamic shear rheometer (DSR) tests on filler-asphalt mortars to determine the rutting and fatigue properties. Fines passing a No. 200 sieve (P200 material) obtained from six different mineral aggregates were included in the study. The P200 materials were characterized by Rigden voids, particle size analysis, methylene blue test, and a German filler test. HMA specimens containing different P200 materials were tested in the Superpave shear test device for rutting and fatigue cracking. AASHTO T283 (modified Lottman test) was used to evaluate moisture susceptibility.

It was found that the D60 size (the particle size that 60% would be passing or smaller than) and methylene blue values were related to rutting, whereas the D10 size (the particle size that 10% would be passing or smaller than) and methylene blue values were related to stripping. No performance-related test was identified for fatigue cracking.

Anderson and Goetz (142) evaluated the stiffening effect of a series of one-sized fillers in one of the first studies that focused on determining the mechanical properties of asphalt filler mixtures. They concluded that both the size of the filler and asphalt binder composition had a significant influence on the stiffening effect. Rigden (143) conducted experiments to study the relationship between filler properties and the viscosity of mineral filler–asphalt cement mixtures. As much as a 1,000-fold increase in viscosity of neat asphalt cement was measured when certain fillers were added to the cement in ratios similar to ratios used in a typical HMA. Rigden showed a strong correlation between the voids content of dry compacted filler and the amount of stiffening produced by the filler.

In 1992, Anderson et al. (144) conducted a study to determine whether the addition of baghouse fines affects the failure or fracture properties of HMA mixtures. No conclusions with respect to fatigue were drawn because of the problems encountered with the test procedures. With respect to fracture properties, it was concluded that the mineral filler fraction could have a significant effect and that

- Gradation does not necessarily relate to stiffening—the finest dust acted in much the same manner as the coarser dust—and
- Fracture toughness, J1c, appeared to be sensitive to the source of the aggregate as well as to the amount of added baghouse dust. In general, the addition of the dust increased the fracture toughness of the HMA mixture.

In another study, Anderson et al. (145) stated that the importance of mineral filler fraction was often overlooked even though it is one of the most important components of HMA. Two mineral fillers, quartz and calcite, were added to four asphalt cements, and the rheological properties and failure properties of the resulting mastics were determined using the test methods developed by SHRP. DSR, flexural creep, and direct tension were found to be applicable to voidless filler–asphalt cement mastics. Based on the study, it was found that

- The addition of the mineral filler does not affect the temperature shift factors of the rheological response but does change the frequency dependency by lengthening the relaxation times, thereby stiffening the asphalt.
- The presence of the mineral filler did not significantly affect the rate or level of oxidative or physical hardening.
- At low temperature the mineral filler imparts a leathery-like behavior to the mastic, enhancing the strain and energy-to-failure characteristics of asphalt cement. “Leathery-like behavior” is used to describe a temperature region for polymers between the glassy and rubbery state and is also referred to as the glass-transition region. In this state, deformation is time dependent and not totally recoverable. Normally, binder might be expected to have a glassy behavior at low temperature, resulting in a brittle failure.

The authors concluded that asphalt mastics can play a major role in defining the performance of HMA. The data also led the authors to conclude that voidless mastics, similar in volume concentration to the mineral filler–asphalt fraction in typical HMA, can be characterized with the same test methods as those developed for neat asphalt cement.

Gubler et al. (146) conducted DSR and bending beam rheometer (BBR) tests on a series of asphalt and binder combinations. Two asphalt binders and three fillers with varied free volumes and ageing conditions were included in their study. The authors believed that stiffening is only one way in which the addition of mineral filler changes the properties of asphalt binder. In fact, mastics behave quite differently than does a binder that is simply stiffer binder. These differences include changes in the material properties with aging and the time and magnitude of loading that are of practical and scientific interest.

Unlike asphalt binder, mastics are susceptible to shear; their mechanical properties are changed by the application of stress during the test itself. Their mechanical properties are also dependent on the amplitude of the applied stress and the time the stress is applied and are thus a function of the testing history. An important decrease in complex modulus (up to a 50% decrease) during testing at intermediate strains, followed by a partial recovery of the modulus during a subsequent period with low strain, was demonstrated in the study.

Their results indicated that filler can promote the oxidation and hardening of asphalt binders. Since it is generally accepted that fatigue is related to hardening of the binder, fatigue must also be related to this phenomenon.

With the increased use of SMA mixtures in the United States, the importance of the mortar in SMA mixtures had been recognized by many researchers. In SMA, the mortar is composed of fine aggregate, filler, asphalt cement, and a stabilizing additive. The mortar is an important component of SMA. It needs to be stiff to help prevent draindown and flushing during production and placement and to resist rutting during in-service life; it must also be flexible enough to resist fatigue and thermal cracking.

Brown et al. (147) conducted a comprehensive study to determine whether SMA mortar can be evaluated by the Superpave system binder tests and to determine the manner in which each of the mortar components affects the overall mortar performance. In the study, for testing purposes, the fine mortar fraction was considered to be a binder and was tested in the Superpave binder equipment before and after aging. The total mortar fraction was considered to be more like a mixture and was tested at low, intermediate, and high temperatures using the BBR, resilient modulus, indirect tensile test, and Brookfield viscometer. Test results indicated how each of the mortar components affects the mortar properties. Most of the stiffening effect comes from the mineral filler. It is believed that the finer the filler, the more stiffening it will provide. However, in this study, the coarser baghouse fines stiffened the mortar more than a limestone dust did. This suggests that filler size is not the only important parameter in specifying fillers. The parent material from which the filler comes as well as filler particle angularity may also be important to SMA. The authors found that with minor modifications, the DSR and BBR appear to offer viable test methods for determining SMA mortar properties. The direct tension test also may be applicable, but will require more modification to testing procedures. The Brookfield viscometer does not seem to be applicable in its present form.

A study was conducted by Mogawer and Stuart (148) to determine whether mastic and mixture properties can distinguish good mineral fillers from poor ones. Eight mineral fillers with known performance were obtained from three European countries. Mastics were tested for stiffness using the BBR, DSR, and ring-and-ball softening point. The authors found that none of the tests distinguished among mastics with good and poor mineral fillers.

Mixtures were tested for draindown of mastic using the NCAT draindown test, for rutting using the LCPC pavement rut tester, for low temperature cracking using the indirect tensile test, for workability using the USACE gyratory testing machine, and for moisture susceptibility using the ASTM D4867 method. None of the tests distinguished among SMA mixtures with good and poor mineral fillers.

There was a good correlation between the free binder content and the stiffness of the mastics measured by the BBR and

the stiffening power measured using the ring-and-ball apparatus. The ramification of this is unknown since the tests did not distinguish between good and poor fillers. The following three conclusions were drawn:

1. A poor correlation existed between the stiffening power measured by the DSR and the free binder content.
2. A poor correlation existed between the percent rut depth measured by the LCPC pavement rut tester and the free binder content.
3. A poor correlation existed between the tensile strengths measured by the indirect tensile strength test and the free binder content.

Cooley et al. (149) conducted a study to evaluate the stiffening potential of baghouse fines using conventional and Superpave binder tests and to establish a reasonable upper limit on the percent bulk volume of dry compacted baghouse fines, as determined by the Pennsylvania State University–modified (Penn State–modified) Rigden void test, which would limit the stiffening potential. This limit could then be used in lieu of dust proportion to more accurately reflect the influence of baghouse fines or filler. Variables included 10 baghouse fines or fillers, 2 grades of asphalt cements, and 4 dust proportions. Tests conducted on unaged filler-asphalt mortars included ring-and-ball softening point, Brookfield viscometer, and DSR at 64°C. Mortars aged in the pressure aging vessel (PAV) were also tested by the DSR at 22°C and the BBR at –18°C.

It was concluded from this study that Penn State–modified Rigden voids test can be used to characterize the stiffening potential of baghouse fines as measured by the softening point, the Brookfield viscometer, and the DSR. Because of the settling of fines during testing with the DSR, only the softening point test and the Brookfield viscometer gave test data that had excellent correlation with the Rigden voids.

Buttlar et al. (150) used particulate composite micro-mechanics models to investigate three reinforcement regimes in asphalt mastics: volume filling, physiochemical effects, and particle interaction. Consistent definitions were given for the three reinforcement mechanisms:

- *Volumetric-filling reinforcement:* The stiffening caused by the presence of rigid inclusions in a less rigid matrix. This stiffening level was assumed to be adequately described by the generalized self-consistent scheme (GSCS) model or by the simplified GSCS-based prediction equations.
- *Physiochemical reinforcement:* The stiffening caused by interfacial effects between asphalt and filler particles, including absorption, adsorption, and selective sorption. The altered asphalt effectively forms a rigid layer, which leads to a higher net volume concentration of rigid matter, which in turn leads to increased mastic stiffness.

- *Particle-interaction reinforcement:* The stiffening beyond volume filling and physiochemical reinforcement. This effect increases with increasing filler content, as rigid matter comes into contact and forms a skeletal framework.

Ishai and Craus (151) summarized a long-term research effort conducted in Israel concerning aggregate and filler properties that have significant influence on the behavior and durability of bituminous paving mixtures. Six types of filler were used in the evaluation of the physicochemical properties of the fillers, the rheological characterization of filler-asphalt mastics, and the strength and durability tests on sand-asphalt mixtures and HMA mixtures. Parameters such as specific surface, shape factor, specific rugosity, and surface texture were evaluated for each filler type. The surface activity of the fillers, as related to interaction with bitumen, was characterized by either adsorption intensity or selective adsorption.

Criteria serving locally (in Israel) as a tool for accepting and rejecting fillers with respect to durability were suggested. They are based on the properties of the filler, the initial properties of the mixture, and the durability behavior of the mixture.

Shashidhar and Romero (152) introduced two intermediate measurable parameters—the maximum packing fraction, ϕ_m , and the generalized Einstein coefficient, K_E —to characterize the asphalt-filler system. This introduction enables a better understanding of the influence of various factors such as average particle size, gradation, particle shape, presence of agglomerates, degree of dispersion, and the asphalt-filler interface on the stiffening potential of asphalt. The following conclusions were drawn from the study:

- The stiffening effect of the fillers increased with decreasing particle sizes below 10 μm . Above 10 μm , such dependencies were not significant.
- The asphalt-filler interface was shown to have a significant effect on stiffening. The interface properties changed from asphalt to asphalt, and the interface can be engineered to yield desired properties.
- Fillers in asphalt had low ϕ_m , indicating that they were poorly dispersed in asphalt.
- Agglomerates were shown to increase K_E , decrease ϕ_m , and therefore to increase stiffening power. Asphalts with agglomerated fillers were shown to have stiffness many times the stiffness of asphalt with unagglomerated fillers.
- An increase in the aspect ratio of the filler particles lowers ϕ_m and increases K_E . Both of these effects increase the stiffening power of fillers.
- Rigden’s fractional voids concept does not take into account the agglomeration, degree of dispersion, and asphalt-filler interface contributions.
- The stiffness of asphalt mastic in a specific system can only be predicted accurately with the measurement of parameters ϕ_m and K_E .

Shashidhar et al. (153) later developed methods evaluating the parameters ϕ_m and K_E . The volume-filling contribution to stiffening was captured by the parameter ϕ_m and the physico-

chemical contribution was captured by K_E . These parameters had a physical basis and were a function of many factors that affected the stiffening potential of fillers.

It was found that the volume-filling contribution to stiffening (ϕ_m) was able to better distinguish between fillers with “good” and “bad” performance in SMA in the cases studied. It was able to predict the performance accurately even in cases in which prediction by Rigden voids had failed. The authors concluded that the stiffness of asphalt by a filler can be fully characterized by measuring the maximum packing fraction, ϕ_m , and the generalized Einstein coefficient, K_E , of the system. The data obtained show that ϕ_m is a better predictor of the performance of filler in SMA than Rigden voids.

The ϕ_m denotes the maximum filler one can put into the system and the volume-filling contribution to stiffening. Mathematically, it is an asymptote at which the stiffening is infinite. ϕ_m is analogous to bulk density in many ways. K_E is the physicochemical contribution to stiffening. It is a measure of the rate of increase in stiffness ratio with the addition of fillers: the higher the K_E , the higher the slope of the curves.

2.9.2 Summary of Research Related to Fines and Fillers

It is widely believed that depending on the particle size, fines can act as a filler or as an extender of asphalt cement binder. Some fines have a considerable effect on the asphalt cement, making it act as a much stiffer grade of asphalt cement compared with the neat asphalt cement. Early work indicated that both the size of the filler and the asphalt binder composition had an impact on the stiffening effect. As much as a 1,000-fold increase in viscosity of the neat asphalt cement was measured when certain fillers were added to asphalt cement. Some fines may also make HMA mixtures more susceptible to moisture-induced damage.

Numerous studies have evaluated the effects of fines, filler, and mortar on HMA performance in the laboratory and in the field. Efforts to characterize fillers have generally followed three paths:

1. **Characterization of particle size or packing.** Several research studies have been conducted to develop suitable test parameters related to particle size or packing to evaluate the fines and fillers. D60 (the particle size of P200 at 60% passing) and methylene blue values were found to be related to rutting, and D10 and methylene blue values to stripping. The modified Rigden voids test has been used to characterize the stiffening potential of baghouse fines.
2. **Binder tests performed on a mortar.** Superpave binder tests, BBR, DSR, flexural creep, and direct tension tests have been used by several researchers to characterize the fine mortar or voidless mastics properties.
3. **Modeling of the overall interaction between the filler and binder.** Recent efforts involve modeling the physical-chemical interaction between fillers and binder.

2.10 EFFECT OF CRUSHING OPERATIONS ON AGGREGATE PROPERTIES

Barksdale (25) states, “Rock is broken or crushed when a force is applied with sufficient energy to disrupt internal bonds or planes of weakness that exist within the rock.” For quarried aggregates, the crushing process begins with the blast that turns solid rock into particles of a size range that can be accepted by the primary crusher. The resulting particles from the initial blast are called “shot rock.” Additional crushing of shot rock or gravel is performed (1) to reduce the aggregate to product size; (2) to improve the aggregate shape; and (3), in the case of gravel for HMA, to create fractured faces. Aggregate is produced in a variety of sizes and for a variety of purposes besides HMA. In some cases, the properties desired for HMA may conflict with those desired for another product.

The ratio between the sieve size representing 80% passing of the crusher feed stock and the sieve size representing 80% passing for the product of the crusher is termed the “reduction ratio” (25). When processing aggregate, a 2:1 reduction ratio will result in at least one fractured face (154). Therefore, when determining the possible number of fractured faces for gravel sources, the feed size and the resulting product size must be considered. It is impossible to create a 12.5-mm crushed gravel having 100% of the particles with one fractured face if the feed stock is only 19.0 mm.

Crushers reduce the size of aggregate particles through three mechanisms: abrasion, cleavage, and impact (Figure 17) (25). Abrasion occurs in localized areas when insufficient energy is applied to the particle to cause significant fracture. Abrasion results in limited size reduction and the production of fines. Cleavage results when the compressive forces applied to

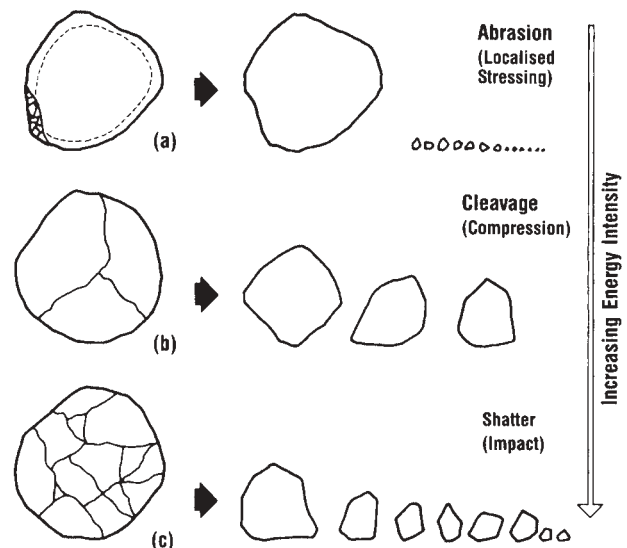

Figure 17. Mechanisms of rock fracture (Figure from Kelley [155] published in Barksdale [25]).

aggregate particles cause a limited number of fracture planes when the aggregate particle is trapped between two crushing surfaces, between other aggregate particles, or between a combination thereof. As shown in Figure 18, cleavage produces a few large particles. Impact-type crushers cause the particle to shatter as it is propelled at high speeds against an anvil or against other aggregate particles. Impact-type crushers produce the widest distribution of particle sizes. Barksdale (25) noted that when producing the same size coarse aggregate product, impact crushers tend to produce a greater percentage of particles passing the 4.75-mm sieve, but compression type crushers produce a greater percentage of material passing the 0.075-mm sieve (dust) within the fine aggregate fraction.

2.10.1 Types of Crushers

There are four major types of crushers used to produce aggregate for HMA: jaw, gyratory, cone, and impact. Jaw, gyratory, and cone crushers are all forms of compression crushers. Compression-type crushers apply a compressive force to the aggregate that is trapped between crushing surfaces. A common characteristic of these machines is that the aggregate must pass through a fixed opening. The fixed opening is adjustable and is referred to as the “close-side” setting (25). Jaw and gyratory crushers apply the crushing force slowly, producing cleavage and abrasion. Cone crushers, a subclass of gyratory crushers, apply their energy approximately twice as fast, producing fracture by shatter as well as by cleavage (25). Examples of jaw and cone crushers are shown in Figures 19 and 20. A complete description of crusher types is provided in Barksdale (25).

Typical reduction ratios for jaw-type crushers are 7:1. Gyratory or cone crushers can produce reduction ratios from 2:1 through 10:1. The use of high-reduction ratios tends to

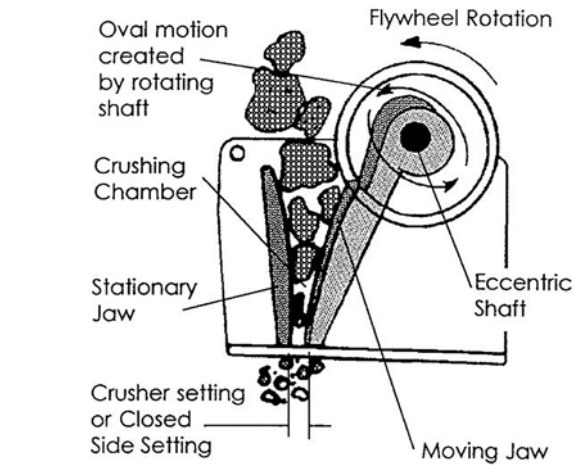

Figure 19. Schematic of a jaw-type crusher (156).

produce excessive fines by overcrushing. Overcrushing occurs when rocks of the desired size are recrushed before they can pass out of the crusher and be removed from the crushing stream by screening.

There are two types of impact crushers, horizontal shaft and vertical shaft. Horizontal shaft impact crushers use one or more rotors, hammers, or rotating pins mounted on a cage. The rotors or hammers directly impact the rock as well as propel the rock against aprons, anvils, or other aggregate particles where further impact occurs. Horizontal shaft impact crushers can produce a high reduction ratio, from 15 through 20 to 1. Horizontal shaft impact crushers are only suitable for low-abrasion aggregate feeds. In a vertical shaft impact crusher, the aggregate feed is introduced into a shoe or pump spinning on a vertical axis. The aggregate feed is thrown centrifugally against a series of anvils, pockets of aggregate particles (i.e., autogenous), or a combination thereof (25). Vertical shaft impact crushers produce a small reduction ratio

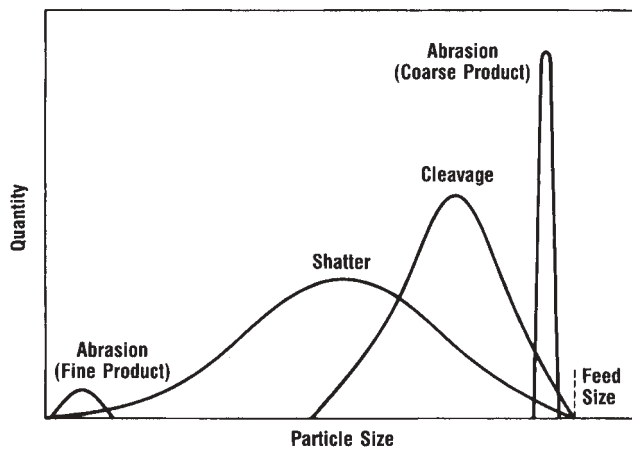

Figure 18. Size distributions resulting from various fracture mechanisms (Figure from Kelley [155] published in Barksdale [25]).

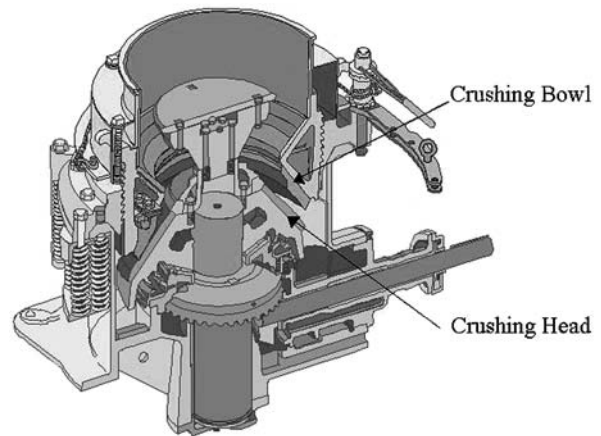

Figure 20. Cutaway view of Symons cone crusher (156, originally from Nordberg, Inc., Milwaukee, WI).

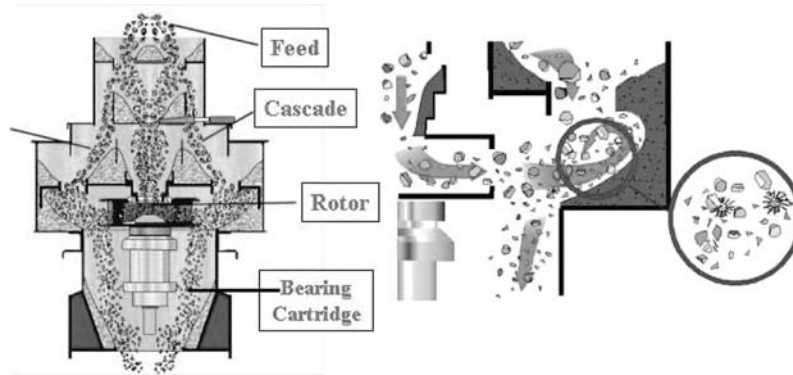

Figure 21. Schematic of Barmac autogenous vertical shaft impact crusher (156, originally from Barmac).

and are often used for crushing fines. An example of an autogenous vertical shaft impact crusher is shown in Figure 21.

Crushers are often referred to by the order in which they crush the aggregate. For instance, the “primary” crusher is the first crusher into which the aggregate feed, either shot rock or gravel, is introduced. Following the primary crusher are the secondary, tertiary, and, in some cases, quaternary crushers—that is, the second, third, or fourth crusher in the crushing circuit. Generally each crusher is used to produce a progressively smaller product, although in some cases, a crusher may be used more for shape improvement and less for size reduction.

2.10.2 Factors Affecting Aggregate Shape

The geology of the aggregate is probably the most significant factor affecting crushed aggregate shape. Fine-grained (i.e., aphanitic) aggregates, such as limestone, tend to be more brittle and therefore fracture into more F&E (157). Slates, injected quartzites, and basalts are examples of other aphanitic aggregates. Quartzites, basalts, and cherts also tend to fracture in a conchoidal manner—that is, they produce curved fracture surfaces like glass (157, 158).

The following factors tend to improve the shape of particles crushed with compression crushers (159–161):

- The crusher should be run with a full or choked feed cavity to promote interparticle crushing.
- Crushers should be operated in closed circuits where a recirculating feed can be used to fill the crusher cavity.
- The reduction ratio should be reduced. Reducing the feed size or increasing the circulating load can accomplish this.
- The close-side setting should be approximately equal to the desired product size.

When single layer (a single aggregate particle trapped between the crusher jaws or crushing head and bowl liner) occurs, the particles are more likely to split in a flat and elongated man-

ner as shown in Figure 22a. This occurs because the stresses are essentially concentrated at two points, causing long cracks in between the contact points. Multilayer crushing produces a greater number of contact points as shown in Figure 22b. Multilayer crushing produces more cubical aggregate shape. Multilayer crushing is achieved by keeping the upper portion of the crusher cavity full or choked. This requires that the crusher be operated as part of a close circuit. A closed circuit provides a recirculating load and surge piles to supply a relatively constant feed rate to the crusher. The feed rate must be adjusted (increased) as the crusher liner wears open or more particles will pass through the open-side setting without being crushed.

The crushing head of gyratory or cone-type crushers oscillates around the central axis of the crusher as shown in Figure 23. As discussed previously, the close-side setting is the smallest distance between the crusher head and the bowl liner. The open-side setting is the largest distance between the crusher head and the bowl liner. The open-side setting occurs at a point opposite the close-side setting. Increasing crusher speed decreases the number of particles that pass through the open-side setting of a cone or gyratory crusher without being crushed. Most older gyratory and cone crushers operate at a fixed speed. Newer high-pressure cone crushers tend to operate at a higher or variable speed.

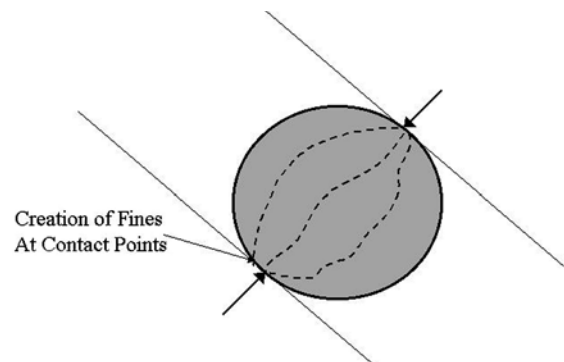

Figure 22a. Single-layer crushing.

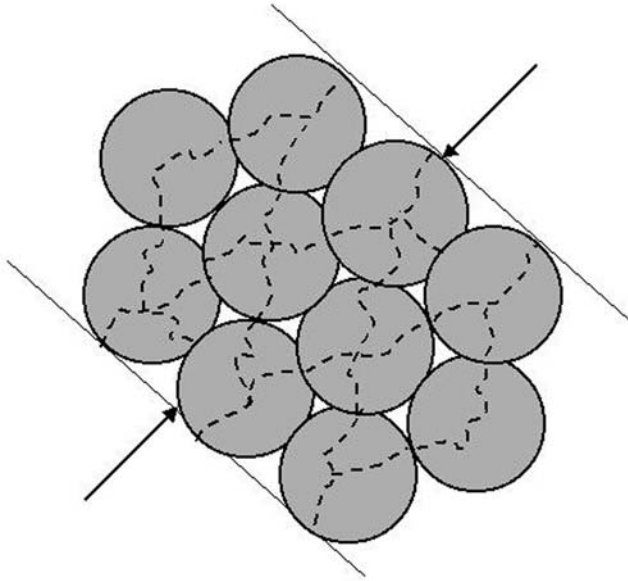

Figure 22b. Multi-layer crushing.

2.10.3 Applications of Crushers

German specifications require that all coarse aggregate used in HMA have less than 20% 3 to 1 particles (162). Good particle shape that meets this criterion can be produced through the use of compression-type crushers, even with granite-diorite aggregates. One German quarry uses a jaw primary crusher and 5.5-ft cone secondary crusher, after which aggregate for HMA passes through a series of four to five short head cone crushers to improve shape (162). Storage is provided to maintain a consistent feed rate. The resulting product is an 8-mm to 11-mm aggregate with typical percent F&E greater than 7% to 9% 3:1 ratio. This is an example of using smaller reduction ratios to improve aggregate shape. Using this method, the quarry produces 3,000 to 4,000 tons per day. However, when specialty stone was produced for an open-graded friction course requiring less than 5% 3:1 particles, production levels were reduced to less than 150 tons

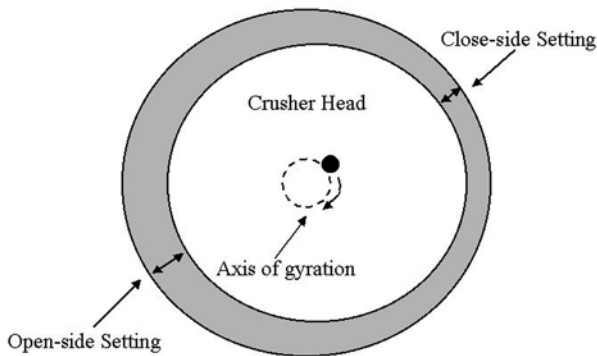

Figure 23. Vertical view of gyratory action of gyratory/cone type crusher.

per day (162). Besides the reduced production rate, the other drawback of this type of production process is the generation of excess crushed fines. Many crushing operations, including this German example, produce more crushed fine aggregate than they can sell.

A related concept to the reduced reduction ratio is the concept of producing product close to the close-side setting of the crusher. A typical crushing operation in the United States might produce ASTM No. 57 stone in combination with ASTM No. 8 stone (159). In this case, the close-side setting of the crusher would be set to approximately 29 mm. Observations indicate that the No. 57 stone would tend to have the best particle shape and that the smaller No. 8 stone would tend to be more flat and elongated. This phenomenon is illustrated in Figure 24, which is produced with data from Jahn (163) for a granite No. 57 stone. The aggregate was tested using the multiple shape ratio method. Producing the No. 8 stone separately from the No. 57 stone could eliminate the effect. However, this process would increase the production of fines and would require additional equipment or reduced production.

Particle shape can also be improved with the use of impact crushers. Shergold (164) states:

It is thought that the good particle shape obtained with impact breakers can be explained with the assumption that, in impact breaking, the stresses have a more or less random distribution, whereas in compressive crushing the stresses are concentrated in relatively closer spaced planes near the surface.

Huber et al. (34) demonstrated the improvement in shape when the same aggregate was crushed with a cone and a vertical shaft impact crusher. No. 57 stone was produced from the same Indiana limestone source in each crusher. Neither crusher produced flat and elongated maximum to minimum particle ratios greater than 5:1. The cone crusher produced 19.4%, and the vertical shaft impact crusher produced 9.0% particles exceeding the 3:1 ratio. One potential drawback of using impact-type crushers to produce coarse aggregate is the resulting effect on the fine aggregate.

Iowa DOT is conducting research to compare the aggregate properties and properties of the resulting aggregate produced with a cone or hammermill (a form of horizontal shaft impact crusher) crusher (165). The study evaluated three aggregate sources. Preliminary results indicate no significant difference in aggregate shape between particles crushed with the cone or hammermill crusher. However, the VMA of the HMA produced with aggregate crushed in the hammermill crusher was consistently 0.7% higher than the VMA of the HMA produced with the cone crusher.

2.10.4 Influence of Shape on Performance

The production of more cubical coarse aggregate can produce more cubical fine aggregate (166, 167). Studies have

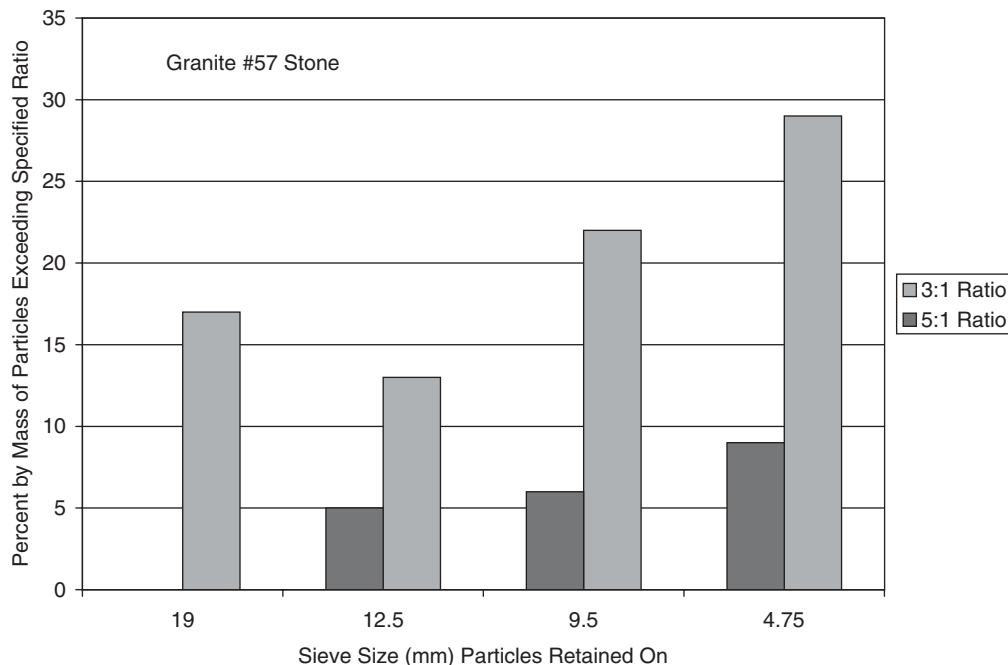

Figure 24. Example of shape variation with particle size.

indicated that cubical fine aggregate particles may pack similarly to round fine aggregate particles, producing low percent uncompacted voids as measured by AASHTO T304 Method A (127, 54). Vertical shaft impact crushers have been used to produce more cubical fine aggregate for use in Portland cement concrete (157, 168, 169). A Virginia stone producer investigated the effects of vertical shaft impact crushers to produce more cubical fine aggregate. The resulting fine aggregate packed more tightly than that previously produced by the quarry. This resulted in an undesirable increase in the unit weight of concrete block produced with the aggregate, resulting in a loss of sales (157). In North Carolina, a quarry separated sand-size particles prior to crushing with a vertical shaft impact crusher to sell to HMA and concrete block plants (168). This illustrates the sometimes divergent requirements of aggregates between different industries.

Aggregate is produced for numerous applications including base, HMA, and Portland cement concrete. The needs of

these products often compete. Cubical coarse aggregates are believed to be desirable for the production of HMA. However, the production of cubical coarse aggregates may result in

- Aggregate base that packs more tightly, reducing drainage capacity;
- More cubical fine aggregate, resulting in lower uncompacted voids;
- Reduced LA abrasion loss;
- More cubical aggregates may pack closer in HMA, resulting in lower VMA;
- More cubical fine aggregate, which packs closer, resulting in higher density block; and
- More cubical fine aggregate that reduces water demand for Portland cement concrete, resulting in higher strength.

Although aggregate shape could seemingly be customized for a given application, in practice this is not possible or, at least, is cost prohibitive.

CHAPTER 3

SURVEY OF CURRENT STATE AGENCY SPECIFICATIONS

3.1 INTRODUCTION

A survey of U.S. state agencies was conducted to assess the adoption of the Superpave consensus and source aggregate properties, gradation bands, and volumetric properties. In addition, the survey included questions regarding problematic aggregates, importation of aggregates, and future research needs. A copy of the survey is included in the appendix. In total, 48 agencies—47 U.S. states and 1 Canadian province—responded to the survey.

3.2 SUPERPAVE CONSENSUS AGGREGATE PROPERTIES

3.2.1 Sand Equivalent Test

The sand equivalent test (AASHTO T176) is used to identify the quantity of clay-like fines in a sample of fine aggregate. Clay-like fines may coat the aggregate such that the asphalt coating the aggregate particles will adhere to the clay instead of to the aggregate particles. In the presence of moisture, the asphalt can then separate from the clay-coated aggregate, leading to moisture damage. AASHTO T76 is specified by 92% of the states that responded to the survey. Two of those states, California and Texas, specify agency test methods that are essentially the same as AASHTO T176. Nevada specifies AASHTO T90, “Plastic Limit and Plasticity Index.” Mississippi specifies AASHTO T88, “Particle Size Analysis of Soils.” Alaska does not specify a test to address plastic fines.

For the states specifying AASHTO T176, 56% specify the same minimum criteria as in AASHTO M323. Four agencies specify less restrictive criteria, the lowest being Georgia DOT’s specification minimum of 28 for limestone aggregates. Minnesota eliminated the sand equivalent requirement for less than 3 million ESALs. The majority of the remaining 10 agencies specify a minimum of 45 for all traffic levels or for up to 30 million ESALs, above which a minimum of 50 is specified in accordance with AASHTO M323. Hawaii requires a minimum of 50 and Arizona a minimum of 55 for all traffic levels. Louisiana only requires the sand equivalent test to be run on natural sands. The frequency distribution of sand equivalent specifications by traffic level is shown in Figure 25. Some aggregate producers have noted that crushed fines from some aggregate types can produce clay-size fines, which lower

the sand equivalent value. They do not believe these fines to be detrimental.

3.2.2 Fine Aggregate Angularity

Superpave specifies the uncompacted voids in fine aggregate test (AASHTO T304 or ASTM C1252, Method A) to ensure that the blend of fine aggregates in an HMA mixture has sufficient angularity, texture, or both to provide resistance to rutting. Prior to the adoption of the Superpave method, many states had limited the amount of natural sand in mixes. In 1997, 23% of states responding to the NCHRP Project 4-19 survey on aggregate properties specified limits on natural sand (170); however, not all natural sands are rounded. Therefore, it was felt that a test such as AASHTO T304 could better qualify fine aggregate.

Of the states responding to the current survey, 85% stated that they specify AASHTO T304 or ASTM C1252 Method A to determine FAA. Arizona uses its own modified version of the test. Oregon ran AASHTO T304 for a period of 2 years and determined that only two sources produced fine aggregate with FAA values below 45, so the test was discontinued. Five other state agencies (10%) do not specify any test to measure FAA. All of these states limit the amount of natural sand that may be used in HMA from 0% to 15%. Texas specifies the Hamburg test to measure the rutting propensity of the HMA mixture in lieu of a test to measure FAA. California has its own test procedure, CTM 205, which measures the number of crushed particles retained on the 4.75-mm and 2.36-mm sieves. California requires 70% crushed particles in the fine aggregate.

Only 51% of the agencies specifying AASHTO T304 specify the requirements outlined in AASHTO M323. The remaining agencies’ criteria are summarized in Table 13. Six of the 17 states report relaxed criteria; the remaining states have more stringent criteria. Oklahoma is considering reducing the minimum to 43 for blends that do not include natural sand or gravel. Ontario allows fine aggregate with a minimum uncompacted void content of 43% if the mixture meets all of the volumetric requirements.

One reported concern is that states were being forced to import fine aggregate to meet FAA requirements. Of the states responding, 28% reported that they imported some aggregate.

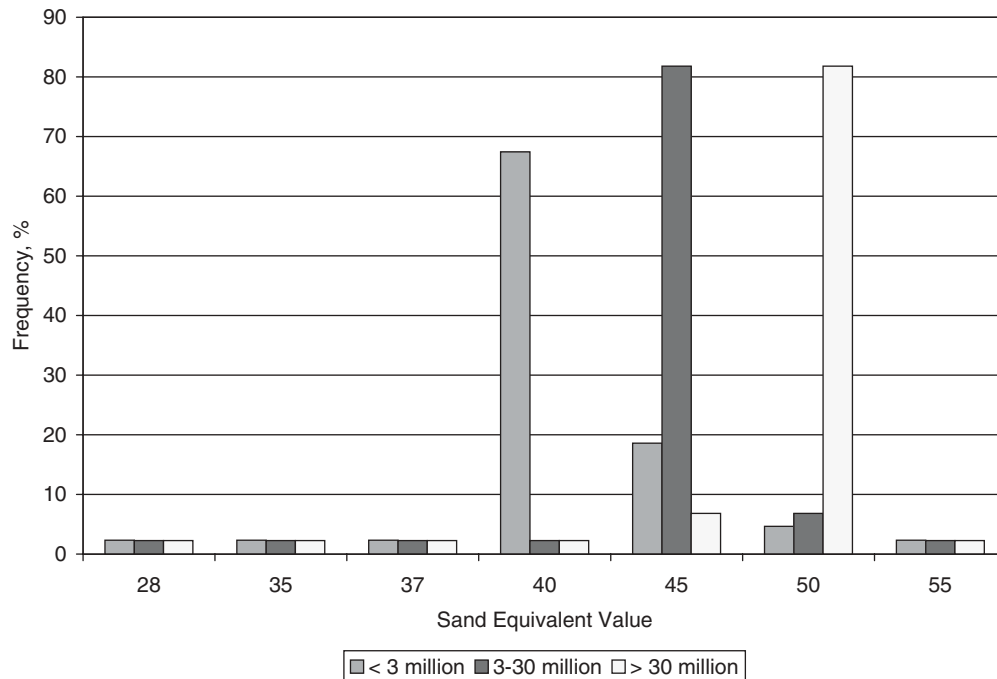

Figure 25. Frequency distribution of sand equivalent specifications by traffic level.

TABLE 13 Summary of AASHTO T304 Specifications differing from AASHTO M323

U.S. State Agency/ Canadian Province	Minimum FAA Specifications
Arizona	42 < 3 M. ESALs, 45 ≥ 3 M. ESALs
Colorado	45 for all traffic levels
Iowa	Use original 7 traffic levels: 40 < 3 M. ESALs, 43 for 3 to 10 M. ESALs, 45 ≥ 10 M. ESALs
Kansas	Surface Mixes (< 100 mm from surface): 42 < 3 M. ESALs, 45 > 3 million ESALs, 40 Shoulder Base Mixes (> 100 mm from surface): 42 < 30 M. ESALs, 45 > 30 M. ESALs, 40 Shoulder
Kentucky	Surface Mixes: 40 < 3 M. ESALs, 45 ≥ 3 M. ESALs Base Mixes: 40 < 30 M. ESALs, 45 ≥ 30 M. ESALs
Louisiana	40 < 3 M. ESALs, 45 > 3 M. ESALs
Michigan	Same except 43 for 1 to 3 M. ESALs when gradation enters restricted zone
Minnesota	Surface Mixes: 40 > 1 M. ESALs, 42 for 1 to 3 M. ESALs, 44 for 10-30 M. ESALs, 45 ≥ 30 M. ESALs Non Wear Mixes: 40 for all traffic levels
Mississippi	4.75 mm NMAS mixes: 45 for all traffic levels 9.5 mm NMAS mixes: 40 < 3 M. ESALs, 44 3 to 10 M. ESALs, No pavements > 10 M. ESALs All other mixes must be coarse graded unless FAA > 44
Missouri	Eliminated reduced requirements for > 100 mm from surface in AASHTO M323
Nebraska	40 for low traffic, 43 for medium traffic, 45 for Interstate pavements
New Mexico	Eliminated reduced requirements for > 100 mm from surface I M323
Ohio	44 for single source or blend, all traffic levels
Ontario	Allow 43 if mixture volumetric properties are satisfied.
Utah	45 for all traffic levels
Virginia	45 for all traffic levels, 40 for 9.5 mm NMAS Subdivision mix
Washington	45 for all traffic levels
Wisconsin	40 < 1 M. ESALs, 43 for 1 to 3 M. ESALs, 45 > 3 M. ESALs

Some of these states only imported aggregate close to their borders where it was actually cheaper to bring in material from out of state. Most state agencies stated that they had done so prior to the use of Superpave. Three states reported importing aggregate to meet frictional requirements. Only one state, New Hampshire, cited importing aggregate to meet FAA values. Two other states, Mississippi and Oklahoma, reported that meeting FAA values could be difficult. Three states reported that minimum VMA requirements were difficult to meet—this may be related to the angularity of the locally available fine aggregate.

FAA requirements and the restricted zone were designed to limit the amount of rounded natural sand allowed in HMA based on “performance” criteria. However, 46% of the responding states continue to limit natural sand by specification; 79% of these also have FAA requirements. As shown in Figure 26, the limits on natural sand ranged from 0% to 50% with most falling between 10% and 15%. Some states had more than one criterion, depending on expected traffic, mix type, or frictional properties. Prior to the adoption of the Superpave method, FHWA recommended limiting natural sand to less than 15%.

3.2.3 Coarse Aggregate Angularity

The coarse aggregate angularity test is used to measure the number of fractured faces on a coarse aggregate particle according to ASTM D5821 or AASHTO TP61-02. A fractured face is defined as a fractured area having sharp edges whose area is equal to at least 25% of the greatest projection

(2-D) of the particle. The original ASTM D5821 test method included a provision for a “questionable” pile. The technician could place an aggregate particle in the questionable pile if he or she were unsure that the fractured face was at least 25% of the projection or if the fractured face had been weathered since the fracture occurred. The mass of particles in the questionable pile could not be more than 15% of the mass of the total sample. This provision is still included in AASHTO TP61. AASHTO M323 specifies a percentage of both one and two fractured faces, by mass, to help provide resistance to rutting.

The coarse aggregate angularity test is used by 83% of the responding agencies who specify ASTM D5821, AASHTO TP61, or an agency version of the test reported to be similar to ASTM D5821 or AASHTO TP61. Twelve of those agencies (25%) specify their own test methods, which are similar to ASTM D5821 or AASHTO TP61. An additional three states (6%) have a test method but did not indicate whether this method was similar to ASTM D5821, and copies of the method have not been obtained. Five states (11%) specify a crushed percentage by definition.

Only 14 agencies (39% of those using ASTM D5821 or a similar procedure) reported that their specified criteria matched AASHTO M323. Four states (11%)—Missouri, North Carolina, Nebraska, and Wyoming—do not use AASHTO’s reduced fractured face requirements for pavement layers deeper than 100 mm (4 in.) in the pavement structure. Altered criteria for the remaining states are shown in Table 14. The altered criteria for one state were not obtainable. Mississippi’s specification addresses previously expressed concerns

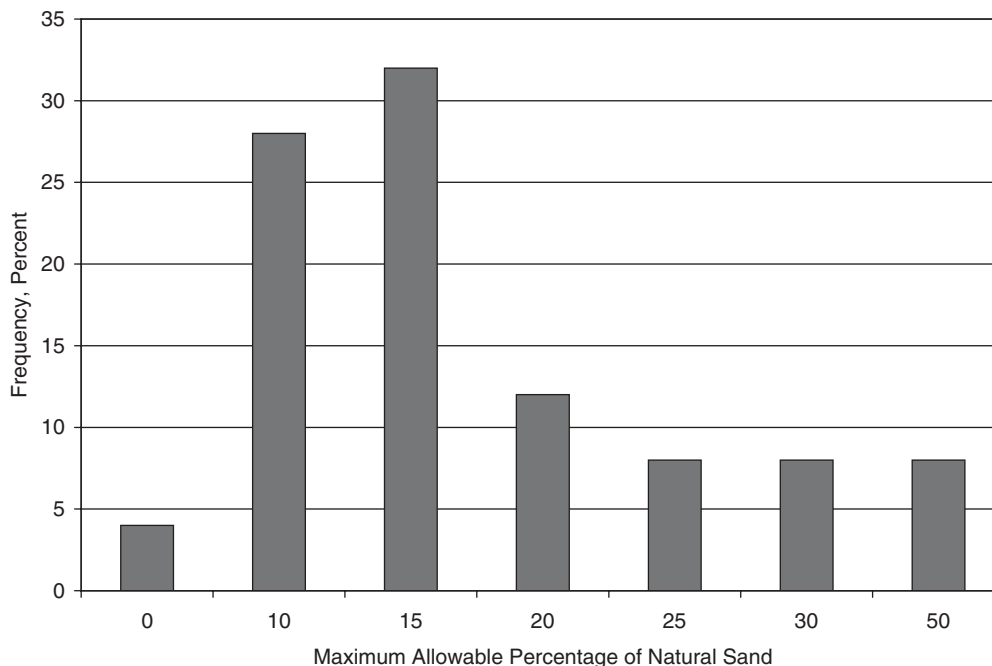

Figure 26. Frequency distribution of natural sand specifications.

TABLE 14 Coarse aggregate angularity criteria for state agencies with altered criteria

Agency	Criteria
Arizona	-/85 ¹ for all traffic levels and depths
Arkansas	98/80 for all traffic levels/depths
Idaho	90/60 for all traffic levels and depths
Kansas	Added requirement of 50/- for < 0.3 million ESALs at a depth greater than 100 mm. 50/- specified for shoulder mixes regardless of depth
Kentucky	75/- < 3 million ESALs, 95/90 3-30 million ESALs, 100/100 > 30 million ESALs
Louisiana	75/- low traffic, 95/- medium traffic, 98/- high traffic
Minnesota	30/30 < 1 million ESALs, 55/55 1-3 million ESALs; > 3 million ESALs match AASHTO M323
Mississippi	-/90 12.5 mm NMAS or smaller, -/80 for 19.0 mm NMAS, -/70 for 25.0 mm NMAS
Montana	75/60 0.3-3 million ESALs; > 3 million ESALs match AASHTO M323
New Jersey	Surface and Intermediate lifts: 95/90 for low, medium and high traffic levels, 100/100 for very high traffic levels Base lifts: 80/75 for low, medium and high traffic levels, 100/100 for very high traffic levels
Utah	95/90 for Category 1 traffic (National Highway System and truck routes); 85/80 for 19.0 and 25.0 mm, 90/90 for 12.5 and 19.0 mm NMAS Category 2 pavements (all others)

¹Percentage of particles with one or more and two or more fractured faces, respectively.

regarding the influence of the parent gravel cobble size on the ability to produced high percentages of fractured faces.

Quarried aggregates are generally expected to have two or more fractured faces. However, for the states that specify a fractured face test, 81% stated that the test was performed on all aggregates, while 19% stated that it was only performed on gravel sources.

3.2.4 Flat and Elongated Particles

Superpave specifies that the percentage of flat *and* elongated particles with a maximum-to-minimum (length-to-thickness) ratio greater than 5 be determined according to ASTM D4791. Flat particles are defined as those particles whose width to thickness exceeds some ratio, typically 5:1 or 3:1. Elongated particles are defined as those particles whose length to width exceeds some ratio, similar to flat particles. AASHTO M323 considers both flat particle and elongated particle shapes to be susceptible to breakdown during production, placement, and compaction and, therefore, specifies the ratio of the maximum-to-minimum dimension of the particle.

ASTM D4791 is specified by 79% of the responding agencies. An additional three agencies (6%) use an agency procedure similar to ASTM D4791. Georgia DOT also uses a method similar to ASTM D4791, but instead of defining the minimum dimension of the particle as the maximum thickness, it instead defines the minimum dimension as the average thickness. This method is a more restrictive test than is ASTM D4791. West Virginia also has its own test procedure. Four states (8%) do not specify any requirements for

F&E. One of these states, Colorado, tested all of its sources and found only two sources that exceeded the 5:1 ratio by more than 2%. The current criterion specified by AASHTO M323 for pavements with more than 1 million ESALs is 10%.

Of the state agencies that specify ASTM D4791 or a similar agency test method, 63% specify criteria that match those outlined in AASHTO M323. Kentucky specifies less than 10% of 5:1 particles for all traffic levels. Connecticut, Hawaii, New Mexico, Utah, and Wyoming specify a maximum of 20% particles exceeding the 3:1 ratio. In Utah, these criteria only apply to the +9.5-mm material. Texas specifies a maximum of 10% of 3:1 particles. Minnesota specifies flat or elongated (width to thickness or length to width, respectively) based on a 3:1 ratio. Only Idaho specifies less restrictive criteria, allowing 15% by weight of particles to exceed the 5:1 ratio. In addition to the 10% 5:1 requirement, Ontario specifies a maximum of 15% or 20% of particles exceeding the 4:1 ratio. Six agencies report having more restrictive requirements for aggregate used in stone mastic asphalt, which are typically a maximum of 20% of 3:1 and 5% of 5:1 particles.

3.3 SOURCE PROPERTIES

3.3.1 Introduction

Source property levels are not specified in the AASHTO Superpave Specifications. Source property tests are generally related to the durability of the aggregate during construction, wetting and drying, freezing and thawing, and resistance to abrasion under traffic as well as to contaminants such as deleterious materials. The need for a different level of source prop-

erties is effected by climate and the ability of various geologies to meet the criteria.

3.3.2 LA Abrasion Test

Information on aggregate hardness and its resulting resistance to degradation during handling and construction is almost universally measured using AASHTO T96, “Los Angeles Abrasion Test.” AASHTO T96 may also be related to the expected polish resistance of the aggregate under traffic. The survey indicated that 96% of the responding agencies specify AASHTO T96. California DOT (CalTrans) and Illinois DOT specify their own version of the test. Only two agencies that responded to the survey, Maine and Ontario, do not specify AASHTO T96. Instead, they specify the micro-deval test. In addition, Ontario specifies the British Standard for Polish Stone Value and Aggregate Abrasion Value. The aggregate abrasion value test was developed by Ontario and produces results similar to the LA abrasion test, with more portable equipment (115).

Figure 27 shows a frequency distribution of the AASHTO T96 criteria specified by state agencies based on 43 responses.

In some cases, the agencies specify varying levels depending on traffic or aggregate type. The frequency distribution in Figure 27 represents the agencies’ most stringent requirements. The states with multiple levels are shown in Table 15.

3.3.3 Sulfate Soundness

Aggregates can deteriorate from wetting and drying or freezing and thawing cycles. The sulfate soundness test simulates the effects of the expansion of water in the aggregate pores during freezing. An aggregate sample is saturated with either a magnesium or sodium sulfate solution, placed in a drying oven, and dried to a constant mass, which causes the sulfate to crystallize in the aggregate pores. Upon reintroducing the sample into the sulfate solution, the sulfate crystals expand when they are rehydrated. This expansion is similar to the expansion of water freezing in the aggregate pores. Of the responding agencies, 73% specify AASHTO T104 for aggregate durability in HMA. Sodium sulfate is specified by 64% and magnesium sulfate by 30% of the agencies specifying AASHTO T104. Two agencies (6%) allow either sodium or magnesium sulfate. Three agencies specify

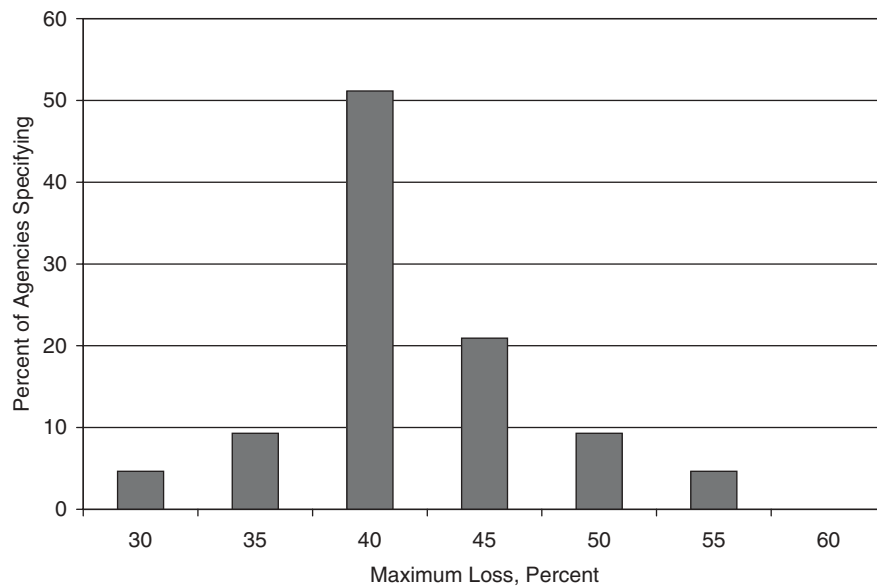

Figure 27. Frequency distribution of AASHTO T96 specifications.

TABLE 15 AASHTO T96 specifications for states with multiple levels

Agency	Maximum Loss (%) by AASHTO T96
Kentucky	40 for most, 50 for sandstone and 60 for slag
Rhode Island	40 for friction course, 50 for others
South Dakota	45 < 0.3 M. ESALs, 40 for 0.3 to 3 M. ESALS, 35 > 3 M. ESALs
Utah	35 for Category 1 and 40 for Category 2 Routes
Wyoming	35 or 40 depending on class

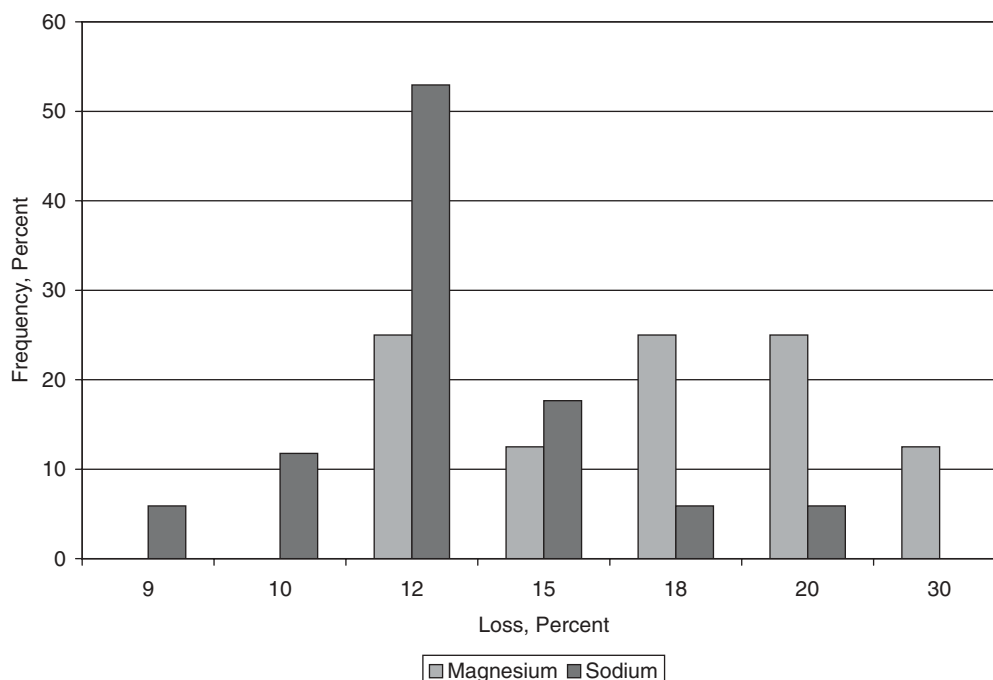

Figure 28. Frequency distribution of sulfate soundness specifications.

freeze-thaw testing. Equipment currently available to easily conduct freeze-thaw testing in the laboratory was not available when the soundness test was developed (115).

The distribution of soundness specifications for coarse aggregate is shown in Figure 28. A maximum allowable loss of less than 12% is specified by 53% of the agencies specifying sodium sulfate soundness. There is little consensus on the criteria for magnesium sulfate soundness, with values ranging from 12% to 30% loss.

3.4 MIX DESIGN PROPERTIES

3.4.1 Gradation

Superpave gradation control consists of control points on four sieve sizes: the maximum aggregate size, NMA, 2.36-mm (No. 8) sieve, and 0.075-mm (No. 200) sieve. Of the responding agencies, 33% have altered the Superpave gradation bands. In some cases, these changes are as simple as adding additional control points between the sieves specified by the Superpave method or altering the range for the percent passing the 0.075-mm (No. 200) sieve. In other cases, agencies have tightened the Superpave gradation bands to produce mixes that more closely resemble dense-graded mixes used prior to Superpave. One agency has modified the Superpave gradation bands to include the 16.0-mm sieve, used prior to the introduction of the Superpave method.

Of the responding agencies, 25% differentiate between coarse- and fine-graded Superpave mixes. Pavement permeability has been a concern with some coarse-graded Superpave mixes. However, only two agencies specify different in-place pavement densities for coarse- and fine-graded Superpave mixes. In addition, Florida DOT includes permeability specifications for coarse- and fine-graded mixes. Two other states have permeability specifications for use during design, and four states are considering permeability specifications.

3.4.2 Aggregate Specific Gravity

The Superpave method specifies the use of the dry bulk aggregate specific gravity for the calculation of VMA. Of the responding agencies, 89% use dry bulk specific gravity to calculate VMA. Four agencies (9%) use the aggregate effective specific gravity to calculate VMA. The effective gravity is determined using the HMA maximum specific gravity or rice value, asphalt content, and binder specific gravity. The effective specific gravity is always larger than the bulk specific gravity and, therefore, results in a larger calculated VMA. The use of the effective aggregate specific gravity to calculate VMA includes the volume of absorbed asphalt as part of the void volume between particles. One agency uses the apparent specific gravity to calculate VMA. This would result in a larger calculated VMA than would be determined using either the bulk or effective aggregate gravities. One state does not calculate VMA.

The aggregate specific gravity is generally determined by the contractor or its representative (65% of respondents). Of the agencies responding, 17% determine the aggregate specific gravity. The dry bulk aggregate specific gravity determined during the design process is used to calculate VMA during production by 52% of the responding agencies. Seven agencies (17%) use the effective specific gravity to calculate VMA during production. Three of these agencies apply a correction factor to the effective gravity to estimate the bulk specific gravity. Four agencies (9%) do not calculate VMA during production. Other agencies publish aggregate specific gravities to be used for design and production. Only two agencies reported measuring the aggregate bulk specific gravity during production.

3.5 SUMMARY OF AGENCY SPECIFICATION SURVEY

One of the goals during the implementation of the Superpave method was the establishment of consistent test methods and specifications for HMA across the United States. Based on the agencies responses, it appears that the first goal has been relatively successful. The majority of the responding agencies specify the Superpave consensus aggregate properties and source property *test methods*; however, lower percentages follow the specification values for the consensus properties. Agencies provided little indication as to the reasoning behind their changes. Past experience was cited in several instances.

CHAPTER 4

REVIEW OF PERFORMANCE DATA FROM FIELD TEST SECTIONS AND FULL-SCALE ACCELERATED TESTING

Currently, a large percentage of the HMA produced in the United States is designed using the Superpave mix design system. The earliest Superpave projects were placed in 1992 (171). A number of experimental field sections have been built and documented by agencies. In 1999, NCAT evaluated the early performance of 44 Superpave sections placed between 1992 and 1998 (172). Some of these sections were revisited in 2001. Unfortunately, the consensus and source aggregate properties are not documented in these reports.

There are a number of accelerated loading facilities in the United States. However, aggregate properties have not been experimental factors in the majority of testing completed to date. One exception is the Indiana DOT/Purdue University APT Facility in West Lafayette, Indiana. Numerous research results from this facility were discussed previously (23, 61, 64–67). In addition, there are three test tracks that have been active since the completion of the Superpave mix design system: MnRoad, WesTrack, and the NCAT Test Track.

4.1 LTPP

There are 773 SPS 1, 5, and 9 HMA test sections (there is often more than one test section per site) listed in LTPP DataPave 3.0 (173). A limited number of the SPS 1 and 5 sections may have been designed using the Superpave method. The majority of the SPS 9 sections were designed using the Superpave method. Unfortunately, the only Superpave consensus aggregate property stored in DataPave is uncompacted voids in fine aggregate. A survey of DataPave 3.0 indicates there are records for 91 HMA layers (multiple layers per section) representing a range of uncompacted void results from 37.6% to 47.9%. Some sand equivalent test results are stored in DataPave 3.0, but only for seal coat treatments.

A data extraction was performed to obtain uncompacted void content, rut depth, date of construction, date of last rut depth measurement, and annual ESALs. In total, uncompacted voids contents were available for 55 surface mixes. Rut-depth measurements were available for all of these sections. There was no trend between total rut depth and uncompacted voids content. This was expected because of the range in age of the pavement sections and varying levels of traffic.

Unfortunately, traffic data were only available in DataPave 3.0 for five adjacent sections in one state. There is a weak relationship ($R^2 = 0.46$) between uncompacted voids content and rut depth divided by the square root of ESALs for the five sections. As shown in Figure 29, the relationship from the limited LTPP data does not match the relationship from the NCAT National Rutting Study (10).

4.2 MNROAD

MnRoad's mainline test road contains 16 HMA sections. Fourteen of these sections, constructed in 1992 and 1993, use the same three stockpiles: a coarse crushed gravel, fine gravel, and crushed granite (174). All fourteen original mainline HMA sections were constructed using the same gradation. The MnRoad mainline experimental variables were design compaction effort, binder grade, and thickness. Two additional Superpave sections were constructed in 1997, one coarse and one through the restricted zone. Originally, 11 HMA sections were constructed on the low-volume test road using the same aggregate stockpiles and gradations as the mainline. Since aggregate type and gradation were not experimental factors in the MnRoad experiment, it is not possible to analyze the relationships between aggregate properties and performance.

4.3 WESTRACK

Aggregate type was not an experimental factor for the 26 original WesTrack sections; a crushed gravel was used for all of the sections (175). Two gradations were used, coarse-graded and fine-graded, both 19.0-mm NMAS. The fines content of the fine-graded mix was also varied. Due to premature failure, a number of the original sections were replaced: eight sections with a crushed andesite aggregate matching the original coarse gradation and two sections with two slightly different dense-graded gradations, one with the original crushed gravel and one with the crushed andesite. However, design compaction effort (Hveem instead of gyratory) and binder grade were also modified for the dense-graded sections. One comparison that can be made is the effect of fractured face count between the two coarse aggregate sources used in the

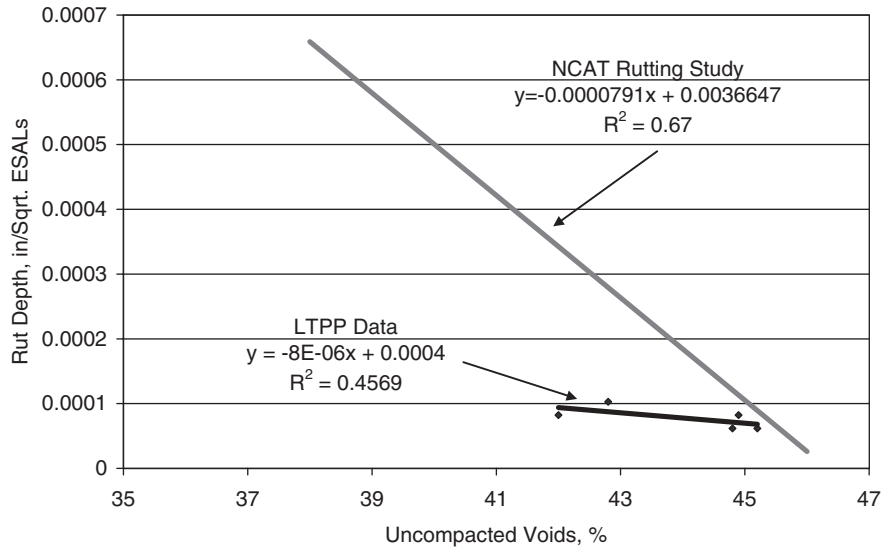

Figure 29. Uncompacted voids versus rut depth normalized by traffic (10).

coarse-graded sections. Hand et al. (176) plotted coarse aggregate angularity (percent two crushed faces) versus rut depth divided by the square root of ESALs along with data from the NCAT National Rutting Study (17) as shown in Figure 30. The results from the WesTrack “fine” and “fine plus” mixes plot close to the regression line. The error on the “coarse” mixes is higher, but still comparable with the other sections. Prior to the implementation of the Superpave method, the use of such coarse mixes was uncommon. Therefore, it is unlikely that similar mixes were included in the National Rutting Study. The “replacement” sections appear to be outliers in the relationship. The replacement sections failed very quickly (at approximately 500,000 ESALs) after being placed in service.

They were placed in service during hot weather. Data from the NCAT Test Track (177) show that rutting did not occur when the 7-day average air temperature dropped below 28°C. The average age of the sections evaluated as part of the National Rutting Study was 5.7 years (10). Therefore, on average the sections in the National Rutting Study that were used to develop the relationship had been through five winters. It is unlikely that rutting would occur during these cooler periods, and yet ESALs would continue to accumulate. Accelerated loading was applied to the replacement sections during warm weather. Based on these considerations, the WesTrack results do not invalidate the results for coarse aggregate angularity from the National Rutting Study.

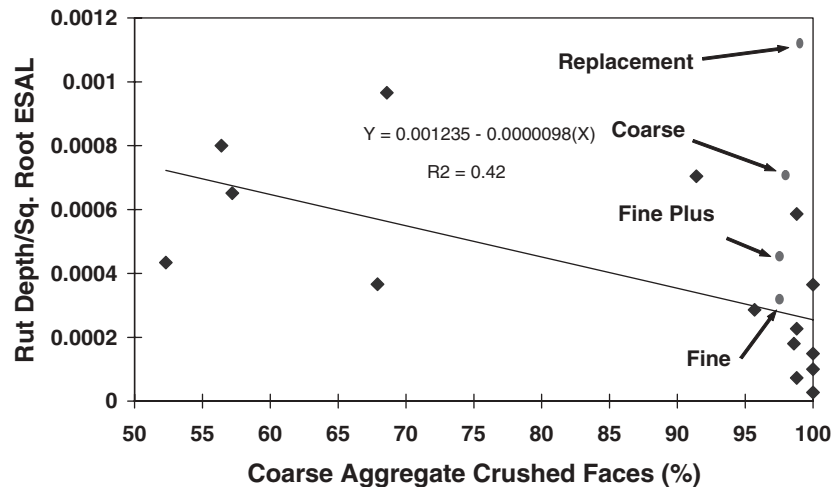

Figure 30. National Rutting Study and WesTrack coarse aggregate angularity relationship to performance (176). ♦ = National Rutting Study. ● = WesTrack.

4.4 2000 NCAT TEST TRACK

Gradation, aggregate type, and NMAS are experimental factors at the NCAT test track (178). Eight aggregate types—quartzite, granite, a limestone-slag blend, gravel, a limestone-recycled asphalt pavement (RAP) blend, a limestone-gravel-RAP blend, sandstone, and quartz gravel—are represented, providing a range of aggregate consensus and source properties. Three NMASs were used: 9.5, 12.5, and 19.0 mm. Four major gradation shapes are included: above the restricted zone (fine), through the restricted zone, below the restricted zone, and SMA gap grading. Structural capacity was not a variable in the 2000 NCAT Test Track. The pavement section consisted of two 2-in. experimental lifts on 15 in. of HMA base. The 19 in. of HMA were placed on top of 5 in. of asphalt treated drainage layer, 6 in. of crushed stone, and 12 in. of A-2 improved subgrade.

The maximum wire-line rut depth after 10 million ESALs was 7.27 mm (179). This level of rutting and the next highest rut depth occurred in two sections with unmodified binder that were placed at optimum +0.5% binder content. This illustrates that there were no true rutting “failures” at the 2000 NCAT Test Track; however, some observations can be drawn from the track performance in relation to aggregate properties.

4.4.1 Effect of Gradation

When the Superpave method was first implemented, the restricted zone excluded many aggregate blends close to the maximum density line that had been used previously. Initially, it was felt that coarse-graded mixes would be more rut resistant than fine-graded mixes. However, the rapid failure of the coarse-graded mixtures in the WesTrack experiment created concern about coarse-graded Superpave mixes. Gradations passing above the restricted zone, through the restricted zone, and below the restricted zone were placed at the 2000 NCAT Test Track. Although each of the sponsoring agencies determined the mixes to be placed on their sections, there are a number of cases in which the effect of gradation can be compared with the same aggregate source and binder grade.

Figure 31 shows comparisons between coarse- and fine-graded mixes produced with PG 67-22 asphalt binder for three aggregate types. An analysis of variance was performed with rut depth as the response variable and gradation and aggregate type as factors. Wire-line rut depths taken at three random locations within each section were used as factors. As shown in Table 16, gradation is not a significant factor affecting rut depth. However, aggregate type and the interaction between aggregate type and gradation are significant.

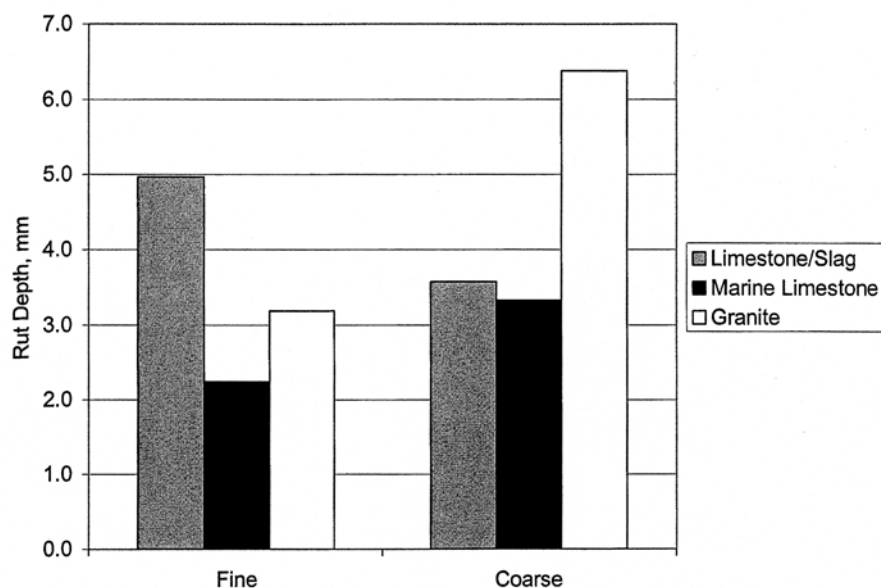

Figure 31. Effect of gradation type on rut depth.

TABLE 16 Analysis of variance on effect of gradation on rut depth

Source	Degrees of Freedom	F-statistic	p-value	Significant at 5%
Aggregate Type	2	6.68	0.011	Yes
Gradation	1	4.30	0.060	No
Aggregate Type·Gradation	2	8.15	0.006	Yes
Error	12			
Total	17			

Brown et al. (179) performed a similar analysis for all of the granite sections on the east tangent of the track. Coarse-graded (below the restricted zone [BRZ]), fine-graded (above the restricted zone [ARZ]), and gradations passing through the restricted zone (TRZ) were included. Each gradation was placed with an unmodified PG 67-22 binder as well as with PG 76-22 binder produced with both SBS (styrene-butadiene-styrene polymer) and SBR (styrene-butadiene rubber) modifiers. The interaction between gradation and binder grade is shown in Figure 32. An ANOVA is shown in Table 17.

In the case of the east curve data, gradation is a significant factor, with the coarse-graded mixes having the largest rut depth followed by the mixes passing through the restricted zone. The mixes with the fine gradations were the most rut resistant. Practically speaking, there was little difference between the rut depths, and all three gradations would perform well.

4.4.2 Relationship Between Aggregate Properties and Performance

The following aggregate tests were performed on the aggregate sources used in the 2000 NCAT Test Track:

- Bulk specific gravity,
- F&E,
- Uncompacted voids in coarse aggregate,
- Uncompacted voids in fine aggregate (FAA),
- Sand equivalent,
- Methylene blue,
- LA abrasion,
- Micro-deval, and
- Sulfate soundness.

Coarse aggregate angularity was not performed even though gravel sources were used at the track. The tests were performed on the aggregate stockpiles, and the blend properties were determined mathematically using a weighted average (percent of blend and percent coarse or fine aggregate were used as weighting factors).

A stepwise regression was performed using the final-wire line rut depth as the response variable for all of the Superpave sections. When only the aggregate properties shown above were used as predictor variables, LA abrasion was the first predictor entered followed by percent passing the 0.075-mm (No. 200) sieve. However, the relationship was not significant for either variable. Other response variables that were

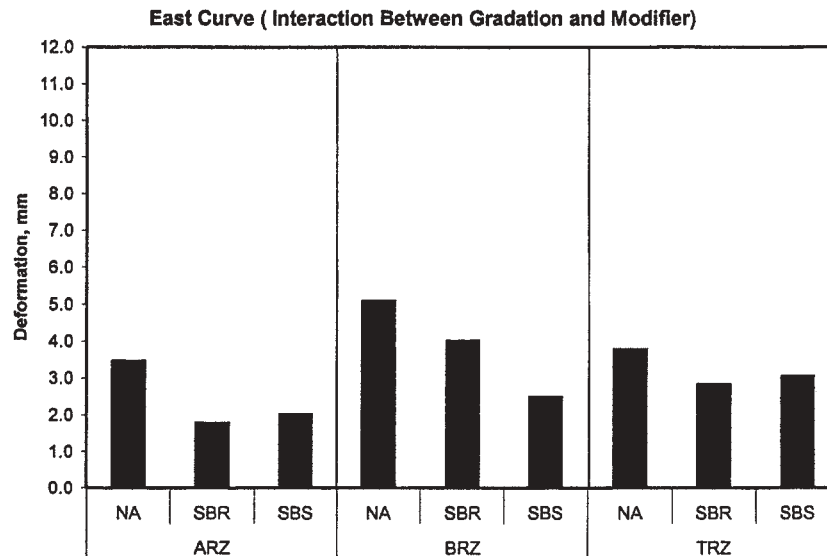

Figure 32. Effect of gradation shape and binder type (east curve) (179).

TABLE 17 Results of analysis of variance on effect of modifier and gradation on rut depth (179)

Source	Degrees of Freedom	Adjusted Mean Squares	F-stat	p-value	Significant? ¹
Gradation (Grad)	2	14.1783	30.18	0.000	Yes
Modifier	2	18.9431	40.33	0.000	Yes
Grad*Modifier	4	3.082	6.56	0.000	Yes
Error	72	0.4697	—	—	—

¹ 5% level of significance.

evaluated included VMA, initial construction density, and densification (change in field density) after 10 million ESALs. The uncompacted void content of the fine aggregate had a significant relationship with the as-constructed density. LA abrasion was the first variable entered for change in density, and uncompacted voids content of fine aggregate was the fourth variable entered. The relationships for both variables were significant.

In order to further analyze the data, the data set was divided by binder grade with all of the PG 67-22 sections grouped together and all of the PG 76-22 sections grouped together. It was felt that the modified binders may be masking the effect of the aggregate properties. There were only nine Superpave sections placed with PG 67-22. Therefore, a stepwise regression could not be performed with the previous group of predictor variables. Instead, individual regressions were performed with aggregate properties such as fine aggregate uncompacted voids, coarse aggregate uncompacted voids, and F&E at the 3:1 ratio, which might be expected to be correlated with rutting. None of the aggregate properties produced significant relationships. For the 19 sections with PG 76-22 binder, an ANOVA performed as part of the regression analysis indicated a poor but significant relationship for the fine aggregate uncompacted void content ($p = 0.011$, $R^2 = 0.31$).

It should be noted that all of the sections in the 2000 NCAT Test Track performed well in rutting. It is difficult to develop relationships between a response variable, such as rut depth, and aggregate properties when all of the rut depths are small, even though traffic, climate, and pavement structure were constant for all of the sections. The application of 10 million ESALs occurred in a 2-year period. Distresses

related to durability are less likely to occur in this short time period.

4.5 SUMMARY OF DATA FROM IN-SERVICE PAVEMENTS AND ACCELERATED LOAD FACILITIES

Numerous Superpave sections have now been in-service for 10 years or longer; however, the data from these sections, particularly aggregate properties, are not readily accessible. The best potential source of data, the LTPP Program, only stores limited Superpave aggregate consensus property data. Attempts to use this data were hindered by a lack of traffic data. The most significant accelerated testing related to aggregate properties has been conducted at the Indiana DOT/Purdue University APT Facility. This work was discussed in Chapter 2. Three test tracks have been operated since the implementation of the Superpave method: MnRoad, WesTrack and the NCAT Test Track. Aggregate properties were not an experimental variable at MnRoad or WesTrack with the exception of the coarse aggregate angularity of the replacement sections at WesTrack. Coarse aggregate angularity data from WesTrack was in general agreement with the relationship developed by Cross and Brown (17). There were a number of different aggregate types and gradations placed at the 2000 NCAT Test Track. All of the sections performed well. Strong correlations were not evident among rutting, VMA, construction density or densification under traffic, and aggregate properties. A weak relationship was obtained between rut depth and fine aggregate uncompacted voids for the sections constructed using PG 76-22 binder.

CHAPTER 5

FUTURE RESEARCH NEEDS

5.1 INTRODUCTION

The Superpave mix design system was developed as part of the SHRP. Aggregate properties were included in the Superpave mix design system; however, their inclusion was not based on laboratory research conducted as part of that study. The current study is to provide a critical review of the aggregate research conducted since the completion of the SHRP and to propose the research needed to fill any gaps.

First, there is a need to emphasize the collection and reporting of aggregate property data for both in-service pavements and for accelerated loading facilities. More effort needs to be placed on capturing aggregate property data in national studies related to HMA performance. NCHRP Project 10-56, “Accelerated Pavement Testing: Data Guidelines,” was recently completed. NCHRP Project 10-56 (published as *NCHRP Report 512: Accelerated Pavement Testing: Data Guidelines [180]*) recommended that aggregate characteristics including “source, gradation, particle shape, surface texture, mineralogy, specific gravity, porosity, toughness, hardness, etc.,” be collected for each aggregate. However, an examination of their recommended protocols suggests that F&E (ASTM D4791) and coarse aggregate angularity (ASTM D5821) are missing for coarse aggregates. It is recommended that the micro-deval test (AASHTO TP58) and the methylene blue test be added and that making samples available for image analysis be added as well.

Two areas were selected for immediate research: (1) the development of performance relationships and criteria for the new imaging methods to measure aggregate shape, angularity, and texture and (2) an investigation of alternatives to and specification limits for the uncompacted voids in fine aggregate test. There is still room for additional research to refine specification limits for such tests as coarse aggregate angularity, F&E (both of which could one day be replaced by imaging), LA abrasion, and micro-deval. Additional refinement of the methylene blue test could make it a likely and more discriminating candidate to replace the sand equivalent test.

NCHRP is currently sponsoring Project 4-30, “Test Methods for Characterizing Aggregate Shape, Texture and Angularity.” The objective of this research is to identify or develop test methods for both central and field laboratories to measure shape, angularity, and texture. Additional research will be required to relate these properties to field performance.

Second, there is significant controversy over the use of AASHTO T304, “Uncompacted Void Content in Fine Aggregate,” to measure FAA. The literature indicates that AASHTO T304 is a reasonable screening tool, but it does classify some cubical crushed fines as being inappropriate for high-traffic volumes. The Compacted Aggregate Resistance (CAR) Test has been proposed as an alternative to AASHTO T304. The CAR test may be more sensitive than AASHTO T304 by providing a greater range of test values. Several of the cubical crushed fines for which there is concern based on the AASHTO T304 results perform well in the CAR test.

5.2 THE RELATIONSHIP BETWEEN TEST METHODS TO CHARACTERIZE AGGREGATE SHAPE, TEXTURE, AND ANGULARITY AND PERFORMANCE OF HMA

Past studies have had difficulty relating coarse aggregate shape, texture, and angularity to field performance. This may, in part, be due to the subjectivity, inaccuracy, and variability of currently used test methods to measure coarse aggregate shape and angularity. New test methods are being evaluated as part of NCHRP Project 4-30A to characterize aggregate shape, texture, and angularity. Devices are to be recommended for application in both central and field labs. A study should be conducted in two phases to relate the results of these tests with expected performance. Phase I should be used to relate the aggregate properties to laboratory performance tests for rutting and fatigue. If possible, workability and compactability should also be evaluated. Phase II should be used to assess aggregates from projects with documented field performance. Results from accelerated loading facilities may be invaluable in this phase.

5.2.1 Laboratory Evaluation

State agencies should be contacted to identify a range of aggregates that have both good and bad performance. Initial screening should be conducted with the recommended devices from NCHRP Project 4-30A. Based on this screening, approximately 10 materials having a range of shape, texture, and angularity should be selected. Such combinations as cubical shape and high texture, cubical shape and low texture, poor shape and high texture, and poor shape and low texture should be targeted.

Mix designs should be developed using these materials. Artificially produced gradations should be avoided because there may be an interaction between aggregate shape, texture, and angularity and material packing. Coarse gradations should be used to better assess coarse aggregate properties, and fine gradations should be produced to better assess fine aggregate properties. For a given aggregate-gradation combination, a mix design should be developed that meets all of the Superpave criteria and that produces a reasonable level of VMA.

Aggregate shape, texture, and angularity would be expected to affect field compactability, rutting, and, possibly, the fatigue characteristics of HMA mixtures. NCAT has developed a prototype HMA workability device (181). A device such as this may be able to assess the effects of aggregate shape, texture, and angularity on the workability of HMA. This vibratory compactor has been used to successfully demonstrate the increased compactability of warm asphalt mixes (182). Since the vibratory compactor is a constant stress device, it can be used to apply constant compaction energy to compare the compactability of various mixes designed using the same number of gyrations.

The rutting potential of the mixes should be assessed using a simple performance test such as a version of the Flow Number Test. In addition, rutting resistance may be assessed using the Asphalt Pavement Analyzer, which has been used more widely by agencies (to date). Fatigue can be evaluated using the beam fatigue test. Though there is a demonstrated shift factor with field performance, fatigue results may be used to rank mixes.

5.2.2 Field Evaluation

If the Phase I laboratory evaluation indicates relationships between aggregate shape, texture, and angularity and field performance, testing should be conducted on aggregates used in actual field sections. Because of the difficulties in accurately determining traffic levels in field test sections, accelerated loading facilities should be utilized as much as possible. Sections should be selected to represent a range of aggregate types, climatic regions, and traffic loads.

5.3 THE RELATIONSHIP BETWEEN THE COMPACTED AGGREGATE RESISTANCE TEST AND RUTTING PERFORMANCE OF HMA

The CAR test has been proposed as an alternate to AASHTO T304. Testing has been conducted by a task group within TRB's Superpave Aggregate and Mixture Expert Task Group to further develop the procedure. However, little testing has been conducted to relate the refined test procedure to field performance. A research study should be conducted on a national scale to relate the CAR test to performance. Companion testing should be performed with AASHTO T304.

5.3.1 CAR Test Parameters

Based on recently performed work, the following test parameters are recommended for the CAR test:

- Gradation,
 - The blended fine aggregate should be tested using the same gradation expected in the fine aggregate fraction of the HMA (material passing the 4.75-mm sieve), and
 - Since some agencies may wish to use the test to approve sources, as-received stockpile samples should also be tested.
- Samples should be blended with 3% moisture.
- Samples should be compacted with 50 Marshall blows on one face.

5.3.2 Laboratory Evaluation

State agencies should be contacted to identify a range of aggregates having both good and bad performance. Efforts should be made to identify several of the cubical, crushed materials that have AASHTO T304 uncompacted void contents between 43 and 45. Natural sands with similar uncompacted voids content should also be identified. Additional testing, such as petrography and the tests from NCHRP Project 4-30A applicable to fine aggregates, should be performed to assess these "borderline" materials.

Fine gradations or gradations through the restricted zone should be produced to better assess fine aggregate properties. Two coarse aggregate sources are recommended: partially crushed gravel and crushed limestone. For a given aggregate-gradation combination, a mix design should be developed that meets all of the Superpave criteria and that produces a reasonable level of VMA.

Rutting potential of the mixes should be assessed using a simple performance test such as a version of the Flow Number Test. In addition, samples might be assessed using the Asphalt Pavement Analyzer, which has been used more widely by agencies to date.

5.3.3 Field Evaluation

If the Phase I laboratory evaluation indicates relationships between aggregate shape, texture, and angularity and field performance, testing should be conducted on aggregates used in actual field sections. Because of the difficulties in accurately determining traffic levels in field test sections, accelerated loading facilities should be utilized as much as possible. Sections should be selected to represent a range of aggregate types, climatic regions, and traffic loads.

CHAPTER 6

CONCLUSIONS AND RECOMMENDATIONS

The results of this review have emphasized the difficult nature of conducting research to relate aggregate properties and HMA performance. It is difficult to isolate the effects of the aggregate properties from other interactions with gradation and mixture volumetric properties. It appears as if the shortcomings of a single property related to rutting resistance can be overcome by other supporting properties.

These interactions emphasize the need for laboratory performance tests for HMA mixtures. If performance tests are adopted that have criteria in which agencies are confident, the overall performance of the mixture could be assessed instead of relying solely on component screening tests—for example, if the blend uncompacted voids in fine aggregate were 43% for a given mixture to be placed on a high-volume road, the rutting properties of this mixture could be tested (at the contractor's expense) to show whether the mix should provide acceptable performance.

6.1 CONSENSUS AGGREGATE PROPERTIES

The consensus aggregate properties have been adopted by the majority of the responding agencies. F&E, specified by 79% of the responding agencies, has the lowest level of implementation.

6.1.1 Coarse Aggregate Angularity

The research revealed the following about coarse aggregate angularity:

- Increased coarse aggregate fractured faces provide increased rutting resistance. Increased particle index value or uncompacted voids in coarse aggregate also provide increased rutting resistance. The latter combine the effect of shape, angularity, and texture.
- The current Superpave specification levels for coarse aggregate angularity have been adopted by 39% of the agencies that specify ASTM D5821 or an equivalent. Five states have more stringent criteria; and four states, less stringent requirements.
- There is little research to support the need for two fractured face counts in excess of 95%.

6.1.2 Fine and Elongated Particles

The research revealed the following about F&E:

- Extreme levels (>10% 5:1 ratio) of F&E are most likely undesirable in HMA.
- Increased levels of F&E increase aggregate breakdown during handling, mixing, and placement.
- The current test for F&E, ASTM D4791, is extremely variable (multilaboratory coefficient of variation of 35.3% for the 3:1 ratio); however, precision improves as the ratio of maximum-to-minimum dimension decreases.
- Seven states currently specify the 3:1 ratio; and one province, the 4:1 ratio. A specification of a maximum of 20% of particles exceeding the 3:1 ratio has been adopted by five states.
- Research has been unable to establish that between 20% and 40% F&E exceeding the 3:1 ratio is detrimental to HMA performance. In fact, some level of F&E may be desirable to meet minimum VMA requirements.
- If ASTM D4791 continues to be used, specifications should be developed for the 2:1 or 3:1 ratio to improve the precision of measurements. Up to 40% F&E exceeding the 3:1 ratio does not appear to be detrimental to pavement performance. Therefore a specification level of up to 40% particles exceeding the 3:1 ratio may be appropriate.
- Imaging methods have been developed to accurately and precisely measure coarse aggregate shape, texture, and angularity and fine aggregate shape. The results with these methods have not yet been correlated with the performance of HMA.
- Research should be conducted to relate digital means for measuring aggregate shape, texture, and angularity to pavement performance as replacements for both coarse aggregate angularity and F&E tests.

6.1.3 Fine Aggregate Angularity

The research revealed the following about FAA:

- Currently, the Superpave mix design system does not address the shape, texture, and angularity of the material

that passes the 4.75-mm (No. 4) sieve and is retained on the 2.36-mm (No. 8 sieve). It does not appear that any of the current consensus property tests can be used to address this size fraction.

- Uncompacted voids in fine aggregate, AASHTO T304, appears to be a reasonable screening test for fine aggregate blends. Numerous other tests have been investigated, but to date none consistently show a better relationship with performance.
- Of agencies that specify AASHTO T304 or an equivalent, 51% have adopted the specification criteria recommended for the Superpave mix design system; 21% of state agencies specify more stringent criteria.
- There are materials with uncompacted voids contents in the range of 43% to 45% that test as false negatives. These materials have a demonstrated history of field performance under high traffic even though they do not meet the uncompacted voids content specifications for high traffic.
- Research should be conducted to relate the CAR test to the rutting performance of HMA. Borderline aggregates that fail the current fine aggregate uncompacted void content specifications for high traffic but that provide good performance should be investigated in-depth as part of this study.
- Of state agencies, 46% continue to limit natural sand content by specifications. Limits between 10% and 15% are most common.

6.1.4 Sand Equivalent

No recent research has been able to corroborate the relationship between clay-like particles, identified by the sand equivalent test, and moisture damage in the laboratory. However, the phenomenon that produces this type of failure may be difficult to duplicate in the laboratory.

The methylene blue value appears to be a better indicator of harmful clays in fine aggregate than is the sand equivalent test. There is concern by some agencies that the test is not suitable for routine specifications.

6.2 SOURCE PROPERTIES

Following are the conclusions reached regarding source properties.

6.2.1 LA Abrasion

The research revealed the following about LA abrasion:

- LA abrasion is related to aggregate breakdown during handling, mixing, placement, and compaction. There

appears to be no relationship between LA abrasion and long-term abrasion or wear of the pavement surface.

- LA abrasion is specified by 96% of responding agencies.
- A maximum LA abrasion loss of 40% is the most common specification level.

6.2.2 Sulfate Soundness

The research revealed the following about sulfate soundness:

- Of the responding agencies, 66% specify sodium sulfate soundness and 31% specify magnesium sulfate soundness.
- A maximum sodium sulfate soundness loss of 12% is specified by the majority of the agencies using that procedure.
- Magnesium sulfate soundness loss and micro-deval abrasion loss are highly correlated. The micro-deval test is also related to abrasion of particles in the pavement.
- The micro-deval test is more precise than the sulfate soundness tests.
- The micro-deval test should replace sulfate soundness test for measuring aggregates' resistance to abrasion, wetting and drying, and slaking. Research may need to be conducted to identify specifications for specific aggregate types, similar to those used by Ontario.
- States prone to freeze-thaw cycles should consider a freeze-thaw test, such as AASHTO T103, in addition to the micro-deval abrasion loss

6.3 GRADATION

The restricted zone—included in the original Superpave mix design system—was demonstrated to be unnecessary. It has been removed from most current Superpave specifications.

Accelerated testing at the 2000 NCAT Test Track indicates no difference in the rutting performance of coarse-graded versus fine-graded Superpave mixtures.

6.4 AGGREGATE PRODUCTION

Following are the conclusions reached regarding source properties:

- In addition to crusher type, aggregate particle shape can be improved by
 - Running the crusher with a full or choked feed cavity to promote interparticle crushing.
 - Operating crushers in closed circuits where a recirculating feed can be used to fill the crusher cavity.
 - Reducing the reduction ratio, reducing the feed size, or increasing the circulating load.

- Adjusting the close-side setting approximately equal to the desired product size.
- Cubical particles can be produced without the use of impact-type crushers.
- The aggregate industry faces divergent requirements for aggregate shape. A change in shape may improve the aggregate for one application, but may hinder its use in another application.

6.5 LONG-TERM PAVEMENT STUDIES AND ACCELERATED TESTING

There is also a need to emphasize the collection and reporting of aggregate property data for both in-service pavements and accelerated loading facilities. More effort needs to be placed on capturing aggregate property data in national studies related to HMA performance.

REFERENCES

- Cominsky, R., R.B. Leahy, and E.T. Harrigan. *Level One Mix Design: Materials Selection, Compaction, and Conditioning*, SHRP A-408. Strategic Highway Research Program, National Research Council, Washington, DC, 1994.
- Kandhal, P.S., and F. Parker, Jr. *NCHRP Report 405: Aggregate Tests Related to Asphalt Concrete Performance in Pavements*, Transportation Research Board, National Research Council, Washington, DC, 1998.
- Kandhal, P.S., and L.A. Cooley, Jr. *NCHRP Report 464: The Restricted Zone in the Superpave Aggregate Gradation Specification*. Transportation Research Board, National Research Council, Washington, DC, 2001.
- Campen, W.H., and J.R. Smith. "A Study of the Role of Angular Aggregates in the Development of Stability in Bituminous Mixtures," *Proceedings of the Association of Asphalt Paving Technologists*, Vol. 17; 1984.
- Field, F. "Effect of Percent Crushed Variation in Coarse Aggregates for Bituminous Mixes," *Proceedings of the Association of Asphalt Paving Technologists*, Vol. 27; 1958.
- Wedding, P.A., and R.D. Gaynor. "The Effect of Using Crushed Gravel as the Coarse and Fine Aggregate in Dense Graded Bituminous Mixtures," *Proceedings of the Association of Asphalt Paving Technologists*, Vol. 30; 1961.
- Boutillier, O.D. "A Study of the Relation Between the Particle Index of the Aggregate and the Properties of Bituminous Aggregate Mixtures," *Proceedings of the Association of Asphalt Paving Technologists*, Vol. 30; 1961.
- Kalcheff, I.V. "Research on Bituminous Concrete Properties with Large-Sized Aggregates of Different Particle Shape" In *Highway Research Board Special Report 109: Effects of Aggregate Size, Shape, and Surface Texture on Properties of Bituminous Mixtures*, Highway Research Board, National Research Council, Washington, DC, 1970.
- Marks, V.J., R.W. Monroe, and J.F. Adam. "Effects of Crushed Particles in Asphalt Mixtures," *Transportation Research Record 1259*, Transportation Research Board, National Research Council, Washington, DC, 1990; pp. 91–106.
- Cross, S.A., and E.R. Brown. "A National Study of Rutting in Asphalt Pavement," *Journal of the Association of Asphalt Paving Technologists*, Vol. 61; 1992; pp. 535–583.
- Parker, F., and E.R. Brown. "Effects of Aggregate Properties on Flexible Pavement Rutting in Alabama," *American Society for Testing and Materials*, STP 1147; 1992.
- Kandhal, P.S., S.A. Cross, and E.R. Brown. "Heavy Duty Asphalt Pavements in Pennsylvania: Evaluation for Rutting," *Transportation Research Record 1384*, Transportation Research Board, National Research Council, Washington, DC, 1993; pp. 49–58.
- Hand, A.J., J.A. Epps, and P.E. Sebaaly. "Precision of ASTM D5821 Standard Test Method for Determining the Percentage of Fractured Particles in Coarse Aggregate," *Journal of Testing and Evaluation*, American Society for Testing and Materials, Vol. 28, No. 2; 2000; pp. 67–75.
- American Society of Testing and Materials. "Road and Paving Materials: Vehicle-Pavement Systems," *Annual Book of ASTM Standards*, Section 4, Vol. 04.03, American Society of Testing and Materials, West Conshohocken, PA, 1995.
- American Association of State Highway and Transportation Officials. *AASHTO Provisional Standards*, American Association of State Highway and Transportation Officials, Washington, DC, 2002.
- American Society of Testing and Materials. "Road and Paving Materials: Vehicle-Pavement Systems," *Annual Book of ASTM Standards*, Section 4, Vol. 04.03, American Society of Testing and Materials, West Conshohocken, PA, 2002.
- Cross, S.A., and E.R. Brown. "Selection of Aggregate Properties to Minimize Rutting of Heavy Duty Pavements," *Effects of Aggregates and Mineral Fillers on Asphalt Mixture Performance*, ASTM STP 1147. American Society for Testing and Materials, Philadelphia, PA, 1992.
- Carlberg, M., C.F. Berthelot, and N. Richardson. "In-Service Rut Performance of Saskatchewan Highways and Transportation Asphalt Concrete Mixes." In *Canadian Technical Asphalt Proceedings 2002*, Calgary, Alberta, 2002.
- Ahlrich, R.C. "Influence of Aggregate Properties on Performance of Heavy-Duty Hot-Mix Asphalt Pavement," *Transportation Research Record 1547*, Transportation Research Board, National Research Council, Washington, DC, 1996; pp. 7–14.
- Kandhal, P.S., M.A. Khatri, and J.B. Motter. "Evaluation of Particle Shape and Texture of Mineral Aggregates and Their Blends," *Journal of the Association of Asphalt Paving Technologists*, Vol. 61; 1992; pp. 217–240.
- Hossain, M.S., F. Parker, Jr., and P.S. Kandhal. "Uncompacted Voids and Particle Index Tests for Evaluating Coarse Aggregate," *Transportation Research Record 1721*, Transportation Research Board, National Research Council, Washington, DC, 2000; pp. 100–105.

22. Hossain, M.S., F. Parker, and Kandhal, P.S. "Comparison and Evaluation of Tests for Coarse Aggregate Particle Shape, Angularity, and Surface Texture," *Journal of Testing and Evaluation*, American Society for Testing and Materials, JTEVA, Vol. 28, No. 2; March 2000; pp. 77–87.
23. Rismantojo, E. "Permanent Deformation and Moisture Susceptibility Related aggregate Tests for Use in Hot-Mix Asphalt Pavements," Doctoral Thesis, Purdue University, West Lafayette, IN, 2002.
24. Roberts, F.L., P.S. Kandhal, D. Lee, and T.W. Kennedy. *Hot Mix Asphalt Materials, Mixture Design and Construction*. National Asphalt Pavement Association, Lanham, MD, 1991.
25. Barksdale, R.D., ed. *The Aggregate Handbook*. National Stone Association, Washington, DC, 1991.
26. U.S. Army Corps of Engineers. "CRD-C119-53: A Method of Test for Flat and Elongated Particles in Coarse Aggregates." In *Handbook for Concrete and Cement*. Vicksburg, MS, 1953.
27. Cominsky, R.J. *The Superpave Mix Design Manual for New Construction and Overlays*. SHRP-A-407. Strategic Highway Research Program, National Research Council, Washington, DC, 1994.
28. SMA Technical Working Group. *Model Material and Construction Guidelines*. Washington, DC, 1994.
29. Li, M.C., and I. Kett. "Influence of Coarse Aggregate Shape on the Strength of Asphalt Concrete Mixtures," *Highway Research Record 178*, Highway Research Board, National Research Council, Washington, DC, 1967.
30. Maupin, G.W. "Effect of Particle Shape and Surface Texture on the Fatigue Behavior of Asphalt Concrete," *Highway Research Record 313*, Highway Research Board, National Research Council, Washington, DC, 1970.
31. Livneh, M., and J. Greenstein. "Influence of Aggregate Shape on Engineering Properties of Bituminous Concrete," *Highway Research Record 404*, Highway Research Board, National Research Council, Washington, DC, 1972.
32. Sharif, R.L. "Fatigue Behavior of Conventional and Rationally Designed Bituminous Mixes on Simulated Subgrade," *Transportation Research Record 549*, Transportation Research Board, National Research Council, Washington, DC, 1975; pp. 15–25.
33. McLeod, N.W., and J.K. Davidson. "Particle Index Evaluation of Aggregates for Asphalt Paving Mixtures," *Journal of the Association of Asphalt Paving Technologists*, Vol. 50.; 1981.
34. Huber, G.A., J.C. Jones, P.E. Messersmith, and N.M. Jackson. "Contribution of Fine Aggregate Angularity and Particle Shape to Superpave Mixture Performance," *Transportation Research Record 1609*, Transportation Research Board, National Research Council, Washington, DC, 1998; pp. 28–35.
35. Brown, E.R., J.E. Haddock, T.A. Lynn, and R.B. Mallick. *CRP-CD-1: Bituminous Materials Research Series; Designing Stone Matrix Asphalt Mixtures Volume II—Research Results for Phase II.*, Final Report for NCHRP Project 9-8, Transportation Research Board, National Research Council, Washington, DC, 1998.
36. Vavrik, W.R., R.J. Fries, and S.H. Carpenter. "Effect of Flat and Elongated Coarse Aggregate on Characteristics of Gyrotory Compacted Samples," *Transportation Research Record 1681*, Transportation Research Board, National Research Council, Washington, DC, 1999; pp. 28–36.
37. Buchanan, M.S. *Evaluation of the Effect of Flat and Elongated Particles on the Performance of Hot Mix Asphalt Mixtures*. NCAT Report No. 2000-03, National Center for Asphalt Technology, Auburn University, 2000.
38. Oduroh, P.K., K.C. Mahboub, and R.M. Anderson. "Flat and Elongated Aggregates in Superpave Regime," *Journal of Materials in Civil Engineering*, American Society of Civil Engineers, Vol. 12, No. 2; May 2000.
39. Aho, B.D., W.R. Vavrik, and S.H. Carpenter. "Effect of Flat and Elongated Coarse Aggregate on Field Compaction of Hot-Mix Asphalt," *Transportation Research Record 1761*, Transportation Research Board, National Research Council, Washington, DC, 2001; pp. 26–31.
40. Estakhri, C. "Evaluation of the Effects of Flat and Elongated Aggregate Particles on Mixture Design and Performance of HMA," Symposium of the International Center for Aggregates Research, 2002.
41. Prowell, B.D., and R. Weingart. "Precisions of Flat and Elongated Particle Tests ASTM D4791 and VDG-40 Videograder," *Transportation Research Record 1673*, Transportation Research Board, National Research Council, Washington, DC, 1999; 73–80.
42. American Society for Testing and Materials. *Annual Book of Standards*, Vol. 04.02, Philadelphia, 1995.
43. *Compilation of Statistics*, (n.d.). Retrieved July 18, 2003, from amrl.net/Portal/PublicDocs/PspStatistics/sect2b.asp#sect15
44. Foster, C.R. "Dominant Effect of Fine Aggregate on Strength of Dense-Graded Asphalt Mixes," In *Highway Research Board Special Report 109: Effects of Aggregate Size, Shape, and Surface Texture on Properties of Bituminous Mixtures*, Highway Research Board, National Research Council, Washington, DC, 1970; pp. 1–3.
45. Monismith, C.L. "Influence of Shape, Size, and Surface Texture on the Stiffness and Fatigue Response of Asphalt Mixtures," In *Highway Research Board Special Report 109: Effects of Aggregate Size, Shape, and Surface Texture on Properties of Bituminous Mixtures*, Highway Research Board, National Research Council, Washington, DC, 1970; pp. 4–11.

46. Kandhal, P.S., J.B. Motter, and M.A. Khatri. "Evaluation of Particle Shape and Texture: Manufactured Versus Natural Sands," *Transportation Research Record 1301*, Transportation Research Board, National Research Council, Washington, DC, 1991; pp. 48–56.
47. McGennis, R.B., R.M. Anderson, T.W. Kennedy, and M. Solaimanian. *Background of Superpave Asphalt Mixture Design and Analysis*. Report SA-95-003. FHWA, U.S. DOT, 1994.
48. American Association of State Highway and Transportation Officials. *Standard Specifications for Transportation Materials and Methods of Sampling and Testing, Part 2B: Tests*, 22nd Edition. AASHTO, Washington, DC, 2002.
49. Hossain, M.S., F. Parker, Jr., and P.S. Kandhal. "Tests for Evaluating Fine Aggregate Particle Shape, Angularity, and Surface Texture," *Transportation Research Record 1673*, Transportation Research Board, National Research Council, Washington, DC, 1999; pp. 64–72.
50. Hudson, B.P. "Modification to the Fine Aggregate Angularity Test Investigation into the Way We Measure Fine Aggregate Angularity," *Proceedings of the 7th Annual Symposium, International Center for Aggregates Research*, Austin, TX, 1999.
51. Roque, R., B. Birgisson, M. Tia, L. Casanova, and E. Kestory. "Evaluation of Superpave Criteria for VMA and Fine Aggregate Angularity, Final Report, Volume 2: Fine Aggregate Angularity," University of Florida, Gainesville, FL, 2002.
52. Marek, C.R. White Paper on Fine Aggregate Angularity. Vulcan Materials Company, 2002.
53. Rismantojo, P., J.E. Haddock, and T.D. White. "Comparison of Fine Aggregate Uncompacted Voids Measured by the ASTM C1252 and VTM-5 Devices," *Journal of Testing and Evaluation*, American Society for Testing and Materials, Philadelphia, PA, 2003.
54. Chowdhury, A., J. Button, V. Kohale, and D. Jahn. *Evaluation of Superpave Fine Aggregate Angularity Specification*. Report No. 201-1, International Center for Aggregates Research, College Station, TX, 2001.
55. Wilson, J.D., and L.D. Klotz. "Quantitative Analysis of Aggregate Based on Hough Transform," *Transportation Research Record 1530*, Transportation Research Board, National Research Council, Washington, DC, 1996; pp. 111–115.
56. Masad E., J.W. Button, and T. Papagiannakis. "Fine-Aggregate Angularity: Automated Image Analysis Approach." *Transportation Research Record 1721*, Transportation Research Board, National Research Council, Washington, DC, 2000; pp. 66–72.
57. Wang, L.B., and L.N. Mohammad. "Quantification of Morphology Characteristics of Aggregate Profile Images," *Preprint: Papers Presented at the 82nd Annual Meeting of the Transportation Research Board*, Washington, DC, 2003.
58. Kecham, R.A., and N. Shashidhar. "Quantitative Analysis of 3-D Images of Asphalt Concrete," *Preprint: Papers Presented at the 82nd Annual Meeting of the Transportation Research Board*, Washington, DC, 2003.
59. Fernandes, J.L., R. Reynaldo, M. Tia, and L. Casanova. "Uncompacted Void Content of Fine Aggregate as Quality Indicator of Materials Used in Superpave Mixtures." *Transportation Research Record 1723*, Transportation Research Board, National Research Council, Washington, DC, 2001; pp. 37–44.
60. Chowdhury, A., and J.W. Button. *Fine Aggregate Angularity: Conventional and Unconventional Approach. Aggregate Contribution to Hot Mix Asphalt (HMA) Performance, ASTM STP 1412*, T.D. American Society for Testing Materials, West Conshohocken, PA, 2002.
61. White, T.D., C.J. Lee, and J.E. Haddock. "Fine Aggregate Angularity," *Proceedings of the 6th Annual Symposium, International Center for Aggregates Research*, St. Louis, MO, 1998.
62. Stuart, K.D. and W.S. Mogawer. "Evaluation of Natural Sands Used in Asphalt Mixtures," *Transportation Research Record 1436*, Transportation Research Board, National Research Council, Washington, DC, 1994; pp. 115–123.
63. Mogawer, W.S., and K.D. Stuart. "Evaluation of Test Methods Used to Quantify Sand Shape and Texture," *Transportation Research Record 1362*, Transportation Research Board, National Research Council, Washington, DC, 1992; pp. 28–37.
64. Lee, C.J., T.D. White, and T.R. West. *Effect of Fine Aggregate Angularity on Asphalt Mixture Performance. Final Report*, FHWA/INDOT/JTRP-98/20, Purdue University, West Lafayette, IN, 1999.
65. Haddock, J., T.D. White, C. Pan, A. Feng, and K. Galal. "Validation of SHRP Asphalt Mixture Specifications Using Accelerated Testing," Interim Report, *National Pooled Fund Study No. 176*, West Lafayette, IN, 1999.
66. Hand, A.J., J.L. Stiadly, T.D. White, A.S. Noureldin, and K. Galal. "Gradation Effects on HMA Performance," *Transportation Research Record 1767*, Transportation Research Board, National Research Council, Washington, DC, 2001; pp. 152–157.
67. Stiadly, J., K. Galal, S. Noureldin, A. Hand, and T. White. *Identification of Aggregate Role in Performance of Superpave Mixtures Employing Accelerated Testing Facility. Aggregate Contribution to Hot Mix Asphalt (HMA) Performance*, ASTM STP 1412, American Society for Testing and Materials, West Conshohocken, PA, 2001.
68. Laboratoire Central des Ponts et Chaussées. *P18-556: Measurement of Particle Size Distribution of Granular Mixtures*. Laboratoire Central des Ponts et Chaussées, Paris. 1994.
69. Chowdhury, A., J.W. Button, D. Wilson, E. Masad, and B.D. Prowell. *Image Analysis Techniques to Determine Fine Aggre-*

- gate Angularity, *Aggregate Contribution to Hot Mix Asphalt (HMA) Performance*, ASTM STP 1412, American Society for Testing and Materials, West Conshohocken, PA, 2001.
70. Stakston, A.D., J.J. Bushek, and H.U. Bahia. "Effect of Fine Aggregate Angularity on Compaction and Shearing Resistance of Asphalt Mixtures," *Transportation Research Record 1789*, Transportation Research Board of the National Academies, Washington, DC, 2002; pp. 14–24.
 71. AASHTO Materials Reference Library. *PSP—Fine Aggregate Proficiency Sample*, (n.d.). Retrieved July 17, 2003, from Patapsco.nist.gov/amrl/psp/Sect2a.asp#31
 72. Watson, D., and M. Issa. *Southeastern Asphalt User/Producer Group Fine Aggregate Angularity Round Robin*. Georgia DOT, Forest Park, GA, 1999.
 73. Maerz, N.H. "Technical and Computational Aspects of the Measurement of Aggregate Shape by Digital Image Analysis." *Journal of Computing in Civil Engineering*, Vol. 18, No. 1, American Society for Civil Engineers; January 2004.
 74. National Cooperative Highway Research Council. NCHRP Project 4-30A, "Test Methods for Characterizing Aggregate Shape, Texture and Angularity," (n.d.). Retrieved December 9, 2003, from www4.nationalacademies.org/trb/crp.nsf/e7bcd526f5af4a2c8525672f006245fa/951ef5e1eb36f4fc85256cdf005715e1?OpenDocument
 75. Barksdale, R.D., M.A. Kemp, W.J. Sheffield, and J.L. Hubbard. "Measurement of Aggregate Shape, Surface Area, and Roughness," *Transportation Research Record 1301*, Transportation Research Board, National Research Council, Washington, DC, 1991; pp. 107–116.
 76. Frost, J.D., and J.S. Lai. "Digital Analysis of Aggregate Particle Shape." *Proceeding of the International Center for Aggregate Research*, Fourth Annual Symposium, Atlanta, GA, 1995.
 77. Kuo, C.-Y., and R.B. Freeman. "Image Analysis Evaluation of Aggregates for Asphalt Concrete Mixtures." *Transportation Research Record 1615*, Transportation Research Board, National Research Council, Washington, DC, 1998; pp. 65–71.
 78. Broyles, D.A., G.T. Adel, and H.W. Rimmer. "Rapid Shape Analysis of Crushed Stone by Computerized Image Processing," *Automation in the Aggregate Industry: The Key to Future Profitability*, National Stone Association Automation Conference, Columbus, OH, 1994.
 79. Weingart, R., and B.D. Prowell. "Specification Development Using the VDG-40 Videograder for Shape Classification of Aggregates." *Proceedings of the Seventh Annual Symposium, International Center for Aggregate Research*. College Station, TX, 1999.
 80. Maerz, N.H. "Aggregate Sizing and Shape Determination Using Digital Imaging Processing." *Proceedings of the Sixth Annual Symposium, International Center for Aggregates Research*, St. Louis, MO, 1998.
 81. Rao, C., and E. Tutumluer. "Determination of Volume of Aggregates: New Image Analysis Approach," *Transportation Research Record 1721*, Transportation Research Board, National Research Council, Washington, DC, 2000; pp. 73–80.
 82. Rao, C., E. Tutumluer, and I.T. Kim. "Quantification of Coarse Aggregate Angularity Based on Image Analysis," *Transportation Research Record 1787*, Transportation Research Board of the National Academies, Washington, DC, 2002; pp. 117–124.
 83. Masad, E. "The Development of a Computer Controlled Image Analysis System for Measuring Aggregate Shape Properties." NCHRP-IDEA Program Project Final Report, NCHRP-IDEA Project 77, National Research Council, Washington, DC, 2003.
 84. Masad, E., and J. Button. "Unified Imaging Approach for Measuring Aggregate Angularity and Texture," *Journal of Computer-Aided Civil and Infrastructure Engineering*, Vol. 15, No. 4; 2000; pp. 273–280.
 85. Kim, H., C.T. Haas, A.F. Rauch, and C. Browne. "A Prototype Laser Scanner for Characterizing Size and Shape Parameters in Aggregates." *Proceedings of the 9th Annual Symposium, International Center for Aggregates Research*, Austin, TX, 2001.
 86. Kim, H., C.T. Haas, A.F. Rauch, and C. Browne. "Wavelet-based Three-Dimensional Descriptors of Aggregate Particles," *Transportation Research Record 1787*, Transportation Research Board of the National Academies, Washington, DC, 2002; pp. 109–116.
 87. Rauch, A.F., C.T. Hass, K. Hyoungkwan, and C. Browne. *Rapid Test to Establish Grading of Unbound Aggregate Products*, Report No. ICAR 503-1, International Center for Aggregate Research, Austin, TX, 2000.
 88. Rauch, A.F., C.T. Haas, C. Browne, and H. Kim. *Rapid Test to Establish Grading of Unbound Aggregate Products: An Evaluation of Automated Devices to Replace and Augment Manual Sieve Analyses in Determining Aggregate Gradation*, Report No. ICAR 503-2, International Center for Aggregate Research, Austin, TX, 2002.
 89. Masad, E., D. Olcott, T. White, and L. Tashman. "Correlation of Imaging Shape Indices of Fine Aggregate with Asphalt Mixture Performance." *Transportation Research Record 1757*, Transportation Research Board, National Research Council, Washington, DC, 2001; pp. 148–156.
 90. Carr, J.R., G.M. Norris, and D.E. Newcomb. "Characterization of Aggregate Shape Using Fractal Dimension," *Transportation Research Record 1278*, Transportation Research Board, National Research Council, Washington, DC, 1990; pp. 43–50.

91. Li, L., P. Chan, D.G. Zollinger, and R.L. Lytton. "Quantitative Analysis of Aggregate Based on Fractals," *ACI Materials Journal*, Vol. 90, No. 4; 1993; pp. 357–365.
92. O'Hara, W.G. "Evaluation of the California Sand-Equivalent Test," *Proceedings of the Highway Research Board*, Vol. 34, 1955.
93. Stroup-Gardiner, M., D. Newcomb, W. Kussman, and R. Olson. "Characteristics of Typical Minnesota Aggregates," *Transportation Research Record 1583*, Transportation Research Board, National Research Council, Washington, DC, 1997; pp. 1–10.
94. Alhozaimy, A.M. "Correlation between Materials Finer than No.200 Sieve and Sand Equivalent Tests for Natural and Crushed Stone Sands," *Journal of the American Society for Testing and Materials*, Vol. 20, Issue 2; 1998.
95. Kandhal, P.S., C. Lynn, and F. Parker. *Test for Plastic Fines in Aggregates Related to Stripping in Asphalt Paving Mixtures*, National Center for Asphalt Technology, Report No. 98-3, 1998.
96. International Slurry Seal Association. "Test Method for Determination of Methylene Blue Absorption Value (MVB) of Mineral Aggregate Filler and Fines," *ISSA Bulletin* No. 145; 1989.
97. Hosking, R. "Road Aggregates and Skidding," *Transportation Research Laboratory, State-of-the-Art Review 4*, HMSO, London, 1992.
98. Cross, S.A., and M.D. Voth. "Evaluation of Anti-Stripping Agents Using the Asphalt Pavement Analyzer," University of Kansas Report KU-99-3, 2001.
99. Aschenbrener, T., and R. Zamora. "Evaluation of Specialized Tests for Aggregates Used in Hot Mix Asphalt Pavements in Colorado," *Transportation Research Record 1486*, Transportation Research Board, National Research Council, Washington, DC, 1995; 130–136.
100. Harders, O., and I. Noesler. "Influence of the Surface Energy Status of Aggregates on the Performance of Asphalt Hot Mix," *9th International Conference on Asphalt Pavements, International Society for Asphalt Pavements*, Copenhagen, Denmark, 2002.
101. Cheng, D.-X., D.N. Little, R.L. Lytton, and J.C. Holste. "Use of Surface Free Energy Properties of the Asphalt-Aggregate System to Predict Damage Potential," *Journal of the Association of Asphalt Paving Technologists*, Vol. 71; 2002.
102. Elphingstone, G.M. "Adhesion and Cohesion in Asphalt-Aggregate Systems," Ph.D. Dissertation, Texas A&M University, 1997.
103. Li, W. "The Measurement of Surface Free Energy for Aggregates SHAP RB," Final report of Cahn Balance Thermogravimetry Gas Adsorption Experiments, 1997.
104. Cheng, D.-X., D.N. Little, R.L. Lytton, and J.C. Holste. "Surface Energy Measurement of Asphalt and Its Application to Adhesion and Moisture Damage of Asphalt-Aggregate System," *Proceedings of the 9th Annual Symposium of the International Center for Aggregate Research*, College Station, TX, 2001.
105. Cheng, D.-X., D.N. Little, R.L. Lytton, and J.C. Holste. "Surface Energy Measurement of Asphalt and Its Application to Predicating Fatigue and Healing in Asphalt Mixtures," *Transportation Research Record 1810*, Transportation Research Board of the National Academies, Washington, DC, 2002; pp. 44–53.
106. Curtis, C.W., K. Ensley, and J. Epps. *Fundamental Properties of Asphalt-Aggregate Interactions Including Adhesion and Absorption*, SHRP-A-341, Strategic Highway Research Program, National Research Council, Washington, DC, 1993.
107. Hicks, R.G., F.N. Finn, C.L. Monismith, and R.B. Leahy. "Validation of SHRP Binder Specification Through Mix Testing," *Journal of the Association of Asphalt Paving Technologists*, Vol. 62; 1993.
108. Terrel, R.L., T. V. Scolz, A. Al-Jacob, and S. Al-Swailmi. "Validation of Binder Properties Used to Predict Sensitivity of Asphalt Mixtures," *Journal of the Association of Asphalt Paving Technologists*, Vol. 62; 1993.
109. Woodward, W.D.H. "Laboratory Predication of Surfacing Aggregate Performance," Ph.D. Thesis, University of Ulster at Jordanstown, Newtownabbey, County Antrim, Northern Ireland, 1995.
110. Woolf, D. O. "The Relation Between Los Angeles Abrasion Test Results and the Service Records of Coarse Aggregates," *Proceedings of the Highway Research Board*, Vol. 17; 1937; pp. 350–359.
111. Melville, P.L. "Weathering Study of Some Aggregates," *Proceedings of the Highway Research Board*, Vol. 28; 1948.
112. Wu, Y., F. Parker, and P.S. Kandhal. "Aggregate Toughness/Abrasion Resistance and Durability/Soundness Tests Related to Asphalt Concrete Performance in Pavements," *Transportation Research Record 1638*, Transportation Research Board, National Research Council, Washington, DC, 1998; pp. 85–93.
113. Amirkhanian, S.N., D. Kaczmarek, and J.L. Burati, Jr. "Effects of Los Angeles Abrasion Test Values on the Strengths of Laboratory Prepared Marshall Specimens," *Transportation Research Record 1301*, Transportation Research Board, National Research Council, Washington, DC, 1991; pp. 77–86.
114. Xie, H., and D.E. Watson. "Lab Study on Degradation of Stone Matrix Asphalt Mixtures." Paper presented at 83rd Annual Meeting of the Transportation Research Board, Washington, DC, 2004.

115. Senior, S.A., and C.A. Rogers. "Laboratory Tests for Predicting Coarse Aggregate Performance in Ontario," *Transportation Research Record 1301*, Transportation Research Board, National Research Council, Washington, DC, 1991; pp. 97–106.
116. Ruth, B.E., and M. Tia. "Aggregate Degradation Testing by Gyrotory Testing Machine," *Transportation Research Record 1619*, Transportation Research Board, National Research Council, Washington, DC, 1998; pp. 3–10.
117. Rogers, C.A., M.L. Bailey, and B. Price. "Micro-Deval Test for Evaluating the Quality of Fine Aggregate for Concrete and Asphalt" *Transportation Research Record 1301*, Transportation Research Board, National Research Council, Washington, DC, 1991; pp. 68–76.
118. Cooley, L.A., Jr., M.H. Huner, and R.S. James. *Micro-Deval Testing of Aggregates in the Southeast* NCAT Report 2002-09, National Center for Asphalt Technology, Auburn, AL, 2002.
119. Rogers, C., B. Gorman, and B. Lane. "Skid-Resistant Aggregates in Ontario." *Proceedings of the 10th Annual Symposium, International Center for Aggregates Research*, College Station, TX, 2002.
120. Tarefder, R.A., M. Zaman, and K. Hobson. "Micro-Deval Test for Evaluating Properties of Roadway Aggregate" *International Journal of Pavements*, Vol. 2, Nos. 1 and 2, 2003; pp. 8–19.
121. Huber, G.A., and T.S. Shuler. *Providing Sufficient Void Space for Asphalt Cement: Relationship of Mineral Aggregate Voids and Aggregate Gradation*, ASTM SPT 1147, Philadelphia, PA, 1992.
122. Hubbard, P., and F.C. Field. "Adaptation of the Stability Test to Include Coarse Aggregate Asphalt Paving Mixtures," *Proceedings of the Technical Sessions of the Association of Asphalt Paving Technologists*, 1932.
123. Goode, J.F., and L.A. Lufsey. "A New Graphical Chart for Evaluating Aggregate Gradations," *Proceedings of the Association of Asphalt Paving Technologists*, Vol. 31; 1962.
124. *Transportation Research Circular E-C044: Bailey Method for Gradation Selection in Hot-Mix Asphalt Design*, Transportation Research Board of the National Academies, Washington, DC, October 2002.
125. Vavrik, W.R., W.J. Pine, and S.H. Carpenter. "Aggregate Blending for Asphalt Mix Design: Bailey Method," *Transportation Research Record 1789*, Transportation Research Board of the National Academies, Washington, DC, 2002; pp. 146–153.
126. Vavrik, W.R., W.J. Pine, G. Huber, S.H. Carpenter, and R. Bailey. "The Bailey Method of Gradation Evaluation: The Influence of Aggregate Gradation and Packing Characteristics on Voids in the Mineral Aggregate," *Journal of the Association of Asphalt Paving Technologists*, Vol. 70; 2001.
127. Anderson, M.R., and H.U. Bahia. "Evaluation and Selection of Aggregate Gradations for Asphalt Mixtures Using Superpave," *Transportation Research Record 1583*, Transportation Research Board, National Research Council, Washington, DC, 1997; pp. 91–97.
128. Hveem, F.N. "Gradation of Mineral Aggregates for Dense Graded Bituminous Mixtures," *Proceedings of the Association of Asphalt Paving Technologists*, Vol. 11; 1940.
129. Nijboer, L.W. *Plasticity as a Factor in the Design of Dense Bituminous Road Carpets*. Elsevier Publishing Company, Inc., 1948.
130. Cooley, L.A., J. Zhang, P.S. Kandhal, A.J. Hand, and A.M. Epps. *Transportation Research Circular E-C043: Significance of Restricted Zone in Superpave Aggregate Gradation Specification*, Transportation Research Board of the National Academies, Washington, DC, September 2002.
131. Watson, D.E., A. Johnson, and D. Jared. "The Superpave Gradation Restricted Zone and Performance Testing with the Georgia Loaded Wheel Tester," *Transportation Research Record 1583*, Transportation Research Board, National Research Council, Washington, DC, 1997; 106–111.
132. Van de Ven, M., A.F. Smit, R. Loris, and R.B. McGennis. "Validation of Some Superpave Design Parameters by Wheel Testing with the Scale Model Mobile Load Simulator," *Proceedings of the 8th International Conference on Asphalt Pavements*, Vol. II, University of Washington, Seattle, WA; August 1997.
133. Roque, R., S.C. Huang, and B. Ruth. "Maximizing Shear Resistance of Asphalt Mixtures by Proper Selection of Aggregate Gradation," *Proceedings of the 8th International Conference on Asphalt Pavements*, Vol. I, University of Washington, Seattle, WA; August 1997.
134. McGennis, R.B. "Evaluation of Materials from Northeast Texas Using Superpave Mix Design Technology," *Transportation Research Record 1583*, Transportation Research Board, National Research Council, Washington, DC, 1997; 98–105.
135. Sebaaly, P.E., D. Ridolfi, R. Gangavaram, and J. Epps. "Selection of the Most Desirable HMA Mixtures," *Transportation Research Record 1590*, Transportation Research Board, National Research Council, Washington, DC, 1997; pp. 99–107.
136. Sousa, J.B., J.C. Pais, M. Prates, R. Barros, P. Langlois, and A.-M. Leclerc. "Effect of Aggregate Gradation on Fatigue Life of Asphalt Concrete Mixes," Paper presented at the 76th Annual Meeting of the Transportation Research Board, Washington, DC, 1997.

137. Haddock, J., C. Pan, A. Feng, and White, T.D. "Effect of Gradation on Asphalt Mixture Performance," *Transportation Research Record 1681*, Transportation Research Board, National Research Council, Washington, DC, 1999; pp. 59–68.
138. El-Basyouny, M., and M.S. Mamlouk. "Effect of Aggregate Gradation on the Rutting Potential of Superpave Mixes," Paper presented at the 78th Annual Meeting of the Transportation Research Board, Washington, DC, 1999.
139. Kandhal, P.S., and R.B. Mallick. "Effect of Mix Gradation on Rutting Potential of Dense Graded Asphalt Mixtures," *Transportation Research Record 1767*, Transportation Research Board, National Research Council, Washington, DC, 2001; pp. 146–151.
140. Kandhal, P.S., K.Y. Foo, and R.B. Mallick. "Critical Review of Voids in Mineral Aggregate Requirements in Superpave," *Transportation Research Record 1609*, Transportation Research Board, National Research Council, Washington, DC, 1998; pp. 21–27.
141. Kandhal, P.S. "Evaluation of Baghouse Fine for Hot Mix Asphalt," *National Asphalt Pavement Association Information Series*, No. 127; 1999.
142. Anderson, D.A., and W.H. Goetz. "Mechanical Behavior and Reinforcement of Mineral Filler-Asphalt Mixtures," *Proceedings of the Association of Asphalt Paving Technologists*, Vol. 42; 1973.
143. Rigden, P.J. "The Use of Filler in Bituminous Road Surfacing," *Journal of the Society of Chemical Industry*, Vol. 66; 1947.
144. Anderson, D.A., R. Dongre, and D.W. Christensen III. "Effect of Minus No.200-Sized Aggregate on Fracture Behavior of Dense-Graded Hot-Mix Asphalt," *Effects of Aggregates and Mineral Fillers on Asphalt Mixture Performance: ASTM STP 1147*, Philadelphia, 1992.
145. Anderson, D.A., H.U. Bahia, and R. Dongre. "Rheological Properties of Mineral Filler-Asphalt Mastics and Its Importance to Pavement Performance," *Effects of Aggregates and Mineral Fillers on Asphalt Mixture Performance: ASTM STP 1147*, Philadelphia, 1992.
146. Gubler, R., Y. Liu, D.A. Anderson, and M.N. Partl. "Investigation of the System Filler and Asphalt Binders by Rheological Means," *Journal of the Asphalt Paving Technologists*, Vol. 68, 1999; pp. 284–304.
147. Brown, E.R, J.E. Haddock, and C. Crawford. "Investigation of Stone Matrix Asphalt Mortars," *Transportation Research Record 1530*, Transportation Research Board, National Research Council, Washington, DC, 1996; pp. 95–102.
148. Mogawer, W.S., and K.D. Stuart. "Effects of Mineral Fillers on Properties of Stone Matrix Asphalt Mixtures," *Transportation Research Record 1530*, Transportation Research Board, National Research Council, Washington, DC, 1996; pp. 86–94.
149. Cooley, L.A., M. Stroup-Gardiner, E.R. Brown, and D.I. Hanson. "Characterization of Asphalt Filler Mortars with Superpave Binder Tests," *Journal of the Asphalt Paving Technologists*, Vol. 67; 1998.
150. Buttlar, W.G., D. Bozkurt, G.G. Al-Khateeb, and A.S. Waldhoff. "Understanding Asphalt Mastic Behavior through Micromechanics," *Transportation Research Record 1681*, Transportation Research Board, National Research Council, Washington, DC, 1999; pp. 157–169.
151. Ishai, I., and J. Craus. "Effects of Some Aggregate and Filler Characteristics on Behavior and Durability of Asphalt Paving Mixtures," *Transportation Research Record 1530*, Transportation Research Board, National Research Council, Washington, DC, 1996; pp. 75–85.
152. Shashidhar, N., and P. Romero. "Factors Affecting the Stiffening Potential of Mineral Fillers," *Transportation Research Record 1638*, Transportation Research Board, National Research Council, Washington, DC, 1998; pp. 94–100.
153. Shashidhar, N., S.P. Needham, B.H. Chollar, and P. Romero. "Prediction of the Performance of Mineral Fillers in Stone Matrix Asphalt," *Journal of the Asphalt Paving Technologists*, Vol. 68; 1999; pp. 222–251.
154. Harms, T. "Crushers Teamed to Make Better Manufactured Sand." 2000. Retrieved August 12, 2003, from www.rockproducts.com/mag/rock_crushers_temed_better_2/
155. Kelley, E.G., and D.J. Spotiswood. *Introduction to Mineral Processing*. John Wiley and Sons, New York, NY, 1982.
156. Personal communication with David Jahn, 2003.
157. Personal communication with Randy Weingart, Luck Stone Corporation, 2003.
158. Plummer, C.C., and D. McGeary. *Physical Geology*, 4th Edition. W.M. C. Brown Publishers, Dubuque, IA, 1988.
159. Personal communication with NCHRP Project 9-35 Aggregate Industry Advisory Panel: David Jahn, Don Powell, and Randy Weingart, June 2003.
160. Kojovic, T. "Crushing Aggregate: Shape and Control." *Quarry Australia Magazine*, Vol. 3, No. 6; June 1995.
161. Magerowski, T. "Superpave—The Shape of Stone to Come." *Aggregates and Roadbuilding Contractor*, 1999. Retrieved August 12, 2003, from www.rocktoroad.com/superpave3.html
162. Personal communication with Jurg Schwinger, 2003.
163. Jahn, D.W. "Evaluation of Aggregate Particle Shapes Through Multiple Ratio Analysis," Presentation made to Transportation Research Council, Washington, DC, 1996; pp. 86–94.

- tion Research Board Superpave Mixture and Aggregate Expert Task Group, 2000.
164. Shergold, F.A. "A Study of the Granulations Used in the Production of Road-Making Aggregate," Road Research Paper No. 44, Department of Scientific and Industrial Research, Her Majesty's Stationary Office, London, England, 1959.
 165. Personal communication with John Hinrichson, 2003.
 166. Jahn, D.W. "Evolving Influence of Superpave on Coarse Aggregate Particle Shape: Changing Flat and Elongated Requirements." *Proceedings of the 6th Annual Symposium, International Center for Aggregates Research*, College Station, TX, 1998.
 167. Jahn, D.W. "A Closer Look at Superpave Aggregate Specifications." *Proceedings of the 4th Annual Symposium, International Center for Aggregates Research*, College Station, TX, 1996.
 168. Manning, A. "Particle Shape—Manufactured Sand Use of Varied Crushers." *Proceedings of the 3rd Annual Symposium, International Center for Aggregates Research*, College Station, TX, 1995.
 169. Ahn, N.-S., and D.W. Fowler. *An Experimental Study on the Guidelines for Using Higher Contents of Aggregate Microfines in Portland Cement Concrete*, Report ICAR 102-1F, International Center for Aggregates Research, College Station, Texas, 2001.
 170. Kandhal, P.S., F. Parker, Jr., and R.B. Mallick. *Transportation Research Circular 479: Aggregate Tests for Hot-Mix Asphalt: State of the Practice*. Transportation Research Board, National Research Council, Washington, DC, 1997.
 171. Anderson, R.M., G.A. Huber, D.E. Walker, and X. Zhang. "Mixture Testing, Analysis, and Field Performance of the Pilot Superpave Projects: The 1992 SPS-9 Mixtures." *Journal of the Association of Asphalt Paving Technologists*, Vol. 69; 2000; pp. 177–211.
 172. Brown, E.R., D. Decker, R. Mallick, and J. Bukowski. "Superpave Construction Issues and Early Performance Evaluation," *Journal of the Association of Asphalt Paving Technologists*, Vol. 68; 1999; pp. 613–660.
 173. U.S. Department of Transportation, Federal Highway Administration. *DataPave 3.0*, FHWA-RD-01-148, 2001.
 174. Stroup-Gardiner, M., and D.E. Newcomb. *Investigation of Hot Mix Asphalt Mixtures at Mn/Road*. MN/RC-97/06, Minnesota DOT, St. Paul, MN, 1997.
 175. U.S. Department of Transportation, Federal Highway Administration. *Performance of Coarse-Graded Mixes at WesTrack—Premature Rutting, Final Report*. FHWA, Washington, DC, 1998.
 176. Hand, A.J., A.E. Epps, and J.A. Epps. "Effects of Aggregate Variability on WesTrack HMA Performance." Paper presented at 8th Annual Symposium of the International Center for Aggregate Research, 2000.
 177. Brown, E.R., L.A. Cooley, Jr., D. Hanson, C. Lynn, R.B. Powell, B.D. Prowell, and D. Watson. *NCAT Test Track: Design, Construction and Performance*, NCAT 02-12. National Center for Asphalt Technology, Auburn, AL, 2002.
 178. Powell, R.B. *As-Built Properties of Experimental Test Sections on 2000 NCAT Pavement Test Track*. Report No. 01-02, National Center for Asphalt Technology, Auburn, AL, 2001.
 179. Brown, E.R., B.D. Prowell, L.A. Cooley, Jr., J. Zhang, and R.B. Powell. "Evaluation of Rutting Performance on the 2000 NCAT Test Track," Paper presented at the Annual Meeting of the Association of Asphalt Paving Technologists, 2004.
 180. Saeed, A.R., and J.W. Hall, Jr. *NCHRP Report 512: Pavement Testing: Data Guidelines*. Transportation Research Board of the National Academies, Washington, DC, 2003.
 181. Gudimettla, J.M., L.A. Cooley, Jr., and E.R. Brown. *Workability of Hot Mix Asphalt*, NCAT Report 03-03. National Center for Asphalt Technology, Auburn, AL, 2003.
 182. Collins, R., and K. Vaughan. "Warm Asphalt Study," Progress Report, Pavement Technology, Inc. 2003.
-

GLOSSARY

AASHTO: American Association of State Highway and Transportation Officials

AIF: angle of internal friction

AIMS: Aggregate Imaging System

ALF: Accelerated Loading Facility

AMRL: AASHTO Materials Reference Laboratory

ANOVA: analysis of variance

APA: Asphalt Pavement Analyzer

APT: Accelerated Pavement Testing

ARZ: above restricted zone

ASTM: American Society for Testing and Materials

BBR: bending beam rheometer

BRZ: below restricted zone

CalTrans: California Department of Transportation

CAR: compacted aggregate resistance

CCD: charged couple device

DOT: department of transportation

DSR: dynamic shear rheometer

DST: direct shear test

ESALs: equivalent single axle loads

ETG: expert task group

F&E: flat and elongated particles

FAA: fine aggregate angularity

FHWA: Federal Highway Administration

GLWT: Georgia Loaded Wheel Tester

GSCS: generalized self-consistent scheme

HMA: hot mix asphalt

IDT: Indirect Tensile Tester

INAPOT: Instron Adhesion Pull-Off Test

ISSA: International Slurry Seal Association

K-index: classification index

LA abrasion: Los Angeles abrasion test

LASS: Laser-Based Scanning System

LCPC: Lab Central des Ponts et Chaussées (France's national road and bridge laboratory)

LTPP: Long-Term Pavement Performance (Program)

MBV: methylene blue adsorption value

MnRoad: Minnesota Road Research Project

MB: methylene blue

NAA: National Aggregate Association

NAT: net adsorption test

NCAT: National Center for Asphalt Technology

NCHRP: National Cooperative Highway Research Program

N_{design} : design number of gyrations

$N_{initial}$: initial number of gyrations

NMAS: nominal maximum aggregate size

OSU: Oregon State University

PAV: pressure aging vessel

PCS: primary control sieve

PG: performance grade

PI: plasticity index

p-value: significance level

QC/QA: quality control–quality assurance

R^2 : coefficient of determination

RAP: recycled asphalt pavement

SBR: styrene-butadiene rubber

SBS: styrene-butadiene-styrene polymer

SCS: secondary control sieve

SGC: Superpave Gyrotory Compactor

SHRP: Strategic Highway Research Program

SMA: stone matrix asphalt

SPS: Specific Pavement Studies

SR: slenderness ratio

SST: Superpave Shear Tester

SKW/UN: SWK Pavement Engineering, Nottingham, UK

TCS: tertiary control sieve

TRB: Transportation Research Board

TRZ: through the restricted zone

UI-AIA: University of Illinois Aggregate Image Analyzer

USACE: United States Army Corps of Engineers

USD: Universal Sorption Device

VFA: voids filled with asphalt

VMA: voids in mineral aggregate

APPENDIX

NCHRP Project 9-35 Aggregate Specification Survey

- 1) Do you use the sand equivalent test (AASHTO T176) to identify clay-like particles in fine aggregate?

If yes, do the minimum specification values as a function of design traffic in your specifications match those in AASHTO MP2?

If no, what test, if any, do you use?

If you use alternate test methods or specification values, what research or experience prompted this change?

- 2) Do you use the fine aggregate angularity test (AASHTO T304) to identify rounded fine aggregates?

If yes, do the minimum specification values as a function of design traffic and depth from the pavement surface in your specifications match those in AASHTO MP2?

If no, what test, if any, do you use?

If you use alternate test methods or specification values, what research or experience prompted this change?

Do you limit the percentage of natural sand in a mix by specification?

- 3) Do you use the coarse aggregate angularity test (ASTM D5821) to identify the number of fractured faces on coarse aggregates?

If yes, do the minimum specification values as a function of design traffic and depth from the pavement surface in your specifications match those in AASHTO MP2?

If ASTM D5821 is specified, do you specify it on all coarse aggregates, or only on gravel sources?

If ASTM D5821 is not specified, what test, if any, do you use?

If you use alternate test methods or specification values, what research or experience prompted this change?

- 4) Do you specify the flat and elongated particle test (ASTM D 4791) to identify misshapen coarse aggregate particles?

If yes, do the minimum specification values as a function of design traffic in your specifications match those in AASHTO MP2?

In addition to the 5 : 1 maximum-to-minimum dimension specified in AASHTO MP2, do you have any additional specification requirements—for example, 3 : 1, 2 : 1, flat particles, or elongated particles?

If you do not specify ASTM D4791, what test, if any, do you use?

If you use alternate test methods or specification values, what research or experience prompted this change?

- 5) Do you use LA abrasion (AASHTO T96) as a source property to identify aggregate hardness and polish resistance?

If you do not use the LA abrasion test, what test if any do you use?

(We will retrieve your specification levels from the specifications you provide.)

- 6) Do you use sodium or magnesium sulfate soundness (AASHTO T104) as a source property for freeze-thaw durability?

Do you allow sodium sulfate, magnesium sulfate, or both?

If you allow both, are your specification requirements the same for both sodium and magnesium sulfate soundness?

If you do not use sodium or magnesium soundness, what test, if any, do you use to qualify aggregate durability?

(We will retrieve your specification levels from the specifications you provide.)

- 7) Are there any other source properties that you specify (please list)?

- 8) Have you modified the Superpave gradation bands from those shown in AASHTO MP2?

If you have altered the gradation bands, why was this done?

9) Do you differentiate between coarse and fine Superpave mixes?

If so, what do you use to differentiate them?

Do you have different density specifications for coarse and fine Superpave mixes?

Do you have permeability specifications that are a function of gradation?

Do you vary recommended lift thickness as a function of gradation or nominal maximum aggregate size?

What are your recommended ranges for lift thickness to nominal maximum aggregate size? (If they are in your specifications that you have sent, please indicate.)

10) What aggregate specific gravity do you use during design to calculate VMA?

- a) Apparent
- b) Effective
- c) Bulk

11) Who determines the aggregate specific gravities used for design?

- a) Contractor
- b) Agency
- c) Other _____

12) What aggregate specific gravity is used during production to calculate VMA and how is it determined?

13) Do your minimum VMA requirements match those found in AASHTO MP2?

- 14) Are your laboratory compaction efforts as a function of traffic level the same as those specified in AASHTO MP2?

- 15) What time interval do you use to calculate design ESALs?

- 16) Please identify your most common aggregate types—for example, granite, limestone, gravel.

- 17) Do you import aggregate from out of state to meet Superpave aggregate properties?

If so, what aggregate properties are difficult to meet?

- 18) Do you have any problematic aggregate sources or types? If so, please identify the aggregate type and typical problem.

- 19) Is there any ongoing or recently completed research you are sponsoring on aggregate properties relevant to this study?

If so, who is conducting this research and where may we obtain copies of reports?

- 20) Do you have any recommendations for additional aggregate research?

 - 21) Do you have any additional comments or recommendations for this research effort?
-

Abbreviations used without definitions in TRB publications:

AASHO	American Association of State Highway Officials
AASHTO	American Association of State Highway and Transportation Officials
APTA	American Public Transportation Association
ASCE	American Society of Civil Engineers
ASME	American Society of Mechanical Engineers
ASTM	American Society for Testing and Materials
ATA	American Trucking Associations
CTAA	Community Transportation Association of America
CTBSSP	Commercial Truck and Bus Safety Synthesis Program
DHS	Department of Homeland Security
FAA	Federal Aviation Administration
FHWA	Federal Highway Administration
FMCSA	Federal Motor Carrier Safety Administration
FRA	Federal Railroad Administration
FTA	Federal Transit Administration
IEEE	Institute of Electrical and Electronics Engineers
ITE	Institute of Transportation Engineers
NCHRP	National Cooperative Highway Research Program
NCTRP	National Cooperative Transit Research and Development Program
NHTSA	National Highway Traffic Safety Administration
NTSB	National Transportation Safety Board
SAE	Society of Automotive Engineers
TCRP	Transit Cooperative Research Program
TRB	Transportation Research Board
TSA	Transportation Security Administration
U.S.DOT	United States Department of Transportation